

Vehicular Dynamic Spectrum Access: Using Cognitive Radio for Automobile Networks

Si Chen

A Dissertation
Submitted to the Faculty of the



Worcester Polytechnic Institute
in partial fulfillment of the requirements for the
Degree of Doctor of Philosophy
in
Electrical & Computer Engineering
by

2012

APPROVED:

Professor Alexander M. Wyglinski, Major Advisor, WPI ECE

Professor Kaveh Pahlavan, WPI ECE

Professor Peder C. Pedersen, WPI ECE

Professor Sudharman K. Jayaweera, University of New Mexico ECE

Abstract

Vehicular Dynamic Spectrum Access (VDSA) combines the advantages of dynamic spectrum access to achieve higher spectrum efficiency and the special mobility pattern of vehicle fleets. This dissertation presents several novel contributions with respect to vehicular communications, especially vehicle-to-vehicle communications. Starting from a system engineering aspect, this dissertation will present several promising future directions for vehicle communications, taking into consideration both the theoretical and practical aspects of wireless communication deployment.

This dissertation starts with presenting a feasibility analysis using queueing theory to model and estimate the performance of VDSA within a TV whitespace environment. The analytical tool uses spectrum measurement data and vehicle density to find upper bounds of several performance metrics for a VDSA scenario in TVWS.

Then, a framework for optimizing VDSA via artificial intelligence and learning, as well as simulation testbeds that reflect realistic spectrum sharing scenarios between vehicle networks and heterogeneous wireless networks including wireless local area networks and wireless regional area networks. Detailed experimental results justify the testbed for emulating a mobile dynamic spectrum access environment composed of heterogeneous networks with four dimensional mutual interference.

Vehicular cooperative communication is the other proposed technique that combines the cooperative communication technology and vehicle platooning, an emerging concept that is expected to both increase highway utilization and enhance both driver experience and safety. This dissertation will focus on the coexistence of multiple vehicle groups in shared spectrum, where intra-group cooperation and inter-group competition are investigated in the aspect of channel access.

Finally, a testbed implementation VDSA is presented and a few applications are developed within a VDSA environment, demonstrating the feasibility and benefits of some features in a future transportation system.

Acknowledgements

Working on the Ph.D. has been a wonderful and often overwhelming experience. I am indebted to many people for making the time working on my Ph.D. an unforgettable experience.

First of all, I am deeply grateful to my advisor Professor Alexander M. Wyglinski. To work with you has been a real pleasure to me, with heaps of fun and excitement. You have been a steady influence throughout my Ph.D. career; you have oriented and supported me with promptness and care, and have always been patient and encouraging in times of new ideas and difficulties; you have listened to my ideas and discussions with you frequently led to key insights.

Furthermore, I am very grateful to my thesis committee: Professor Kaveh Pahlavan , Professor Peder C. Pedersen , and Professor Sudharman K. Jayaweera , for their encouragement, insightful comments, and hard questions.

In addition, I have been very privileged to get to know and to collaborate with many other great people who became friends over the last several years. My sincere thanks also goes to Dr. Onur Altintas and Rama Vuyyuru for offering me the summer internship opportunities in their groups and leading me working on exciting projects. Over the last few years, Dr. Chittabrata Ghosh and Sean Rocke have been faithful friends and co-authors. Thank you for teaching me so much in our joint research.

I thank my fellow labmates in Wireless Innovation Lab: Dr. Srikanth Pagadarai, Zhou Yuan, Di Pu, Michael Leferman, Kevin M. Bobrowski, and Sean Rocke.

I am also grateful to the following former or current staff at Worcester Polytechnic Institute, for their various forms of support during my graduate study—Robert Brown, Cathy Emmerton, Colleen Sweeney, Brenda McDonald, Stacie Murray, Shannon Cotter, and Louis the custodian.

Most importantly, none of this would have been possible without the love and patience of my family. I would like to express my heart-felt gratitude to my parents, Kang Chen and Gan Lv, who have provided much moral and material support during the long years of my education.

Contents

List of Figures	vii
List of Tables	x
1 Introduction	1
1.1 Motivation	1
1.2 Current State-of-the-Art	5
1.3 Research Contribution	7
1.4 Dissertation Organization	10
2 Background Knowledge of Vehicle Communications and Cognitive Radio	11
2.1 Vehicle Communications	11
2.1.1 Challenges and State-of-the-Art	15
2.2 Spectrum Scarcity	18
2.3 Spectrum Occupancy and Utilization	20
2.3.1 Television Broadcast Channels	20
2.3.2 WiFi Channels	24
2.4 Software Defined Radio and Cognitive Radio	26
2.4.1 Software Defined Radio	26
2.4.2 Cognitive Radio	27
2.5 Machine Learning in CR	29
2.5.1 Reinforcement Learning	30
2.5.2 Metaheuristic Search	31
2.5.3 Case-Based Reasoning	32
2.5.4 The Learning Paradigm of Cognitive Radio Networks	33
2.6 Cooperative Communications	34
2.7 Chapter Summary	37
3 Vehicular Dynamic Spectrum Access	38
3.1 The Ecosystem of Vehicular Communications	38
3.2 Queueing Model for VDSA Capacity	39
3.2.1 Queueing Theory	40
3.2.2 System Modeling using Queueing Theory	41
3.2.3 Solutions for the Queueing Model	45

3.2.4	Analysis of VDSA in Vacant UHF TV channels	47
3.3	Summary	51
4	Intelligence in Vehicle Communications	52
4.1	Proposed System Architecture	52
4.1.1	Case-Based Reasoning Cycle	53
4.1.2	Reinforcement Learning Cycle	54
4.2	Learning-based Adaptive Channel Selection	54
4.2.1	Problem Formulation for Learning Channel Selection in VDSA	55
4.2.2	Solution Design	56
4.3	Evaluation in Shared TV Whitespace	59
4.3.1	Channel Utilization	61
4.3.2	Channel Sensing	62
4.3.3	Adaptation of Learning parameters	62
4.3.4	Simulation Setup	63
4.3.5	Simulation Results	63
4.4	Summary	66
5	Cooperative Communication in Vehicular Communications	67
5.1	System Model	68
5.2	Performance Analysis	72
5.2.1	Without Intra-group Cooperation	72
5.2.2	Cooperative Group Performance Analysis	73
5.2.3	Performance of the Non-cooperating Group	75
5.3	Simulation Results	76
5.4	Summary	84
6	VDSA Implementation and On-road Experiments	85
6.1	Introduction	85
6.2	System Design	87
6.2.1	Hardware Implementation	87
6.2.2	Database Implementation	89
6.2.3	Channel Utilization Measurement	89
6.2.4	Driver Issues and Modification	93
6.3	Feature Demonstration	94
6.3.1	Channel Measurement	94
6.3.2	Channel Synchronization	95
6.3.3	Channel Adaptation	98
6.4	Limitation, Open Issues, and Future Work	101
7	Conclusion	104
A	A MATLAB GUI Tool For Queueing Analysis	107
B	VDSA Simulator Based on OMNeT++	109

List of Figures

1.1	Google’s driverless car using LIDAR to detect environment [1].	2
1.2	A car platoon experiment by PATH[2].	2
1.3	Electromagnetic wave spectrum from 30 Hz to Gamma rays. (from [3]) . . .	3
1.4	Dissertation Organization.	10
2.1	Capability of modern vehicles	12
2.2	Types of cooperative vehicular communications and networks.	13
2.3	Road test and simulation demonstration of vehicle platooning.	14
2.4	A screenshot of Veins [4] simulator suit for vehicle communications.	17
2.5	Optional caption for list of figures	19
2.6	A map of the forty eight locations close to I-90 between Boston, MA and West Stockbridge, MA over which spectrum measurements were collected on June 7, 11, and 12, 2009	21
2.7	Energy Spectral Density plots for the TV frequencies in the higher frequency range <i>i.e.</i> , 470 – 806 MHz across 48 locations close to I-90 between Boston, MA and West Stockbridge, MA (from [5]).	22
2.8	Energy Spectral Density plots for the TV frequencies in the frequency range, 600 – 750 MHz over 550 time sweeps close on I-90 between Boston, MA and West Stockbridge, MA. The measurement setup was located in a vehicle moving at an average velocity of 60 miles/hr (from [5]).	23
2.9	TV Channel availability at different locations along I-90 in the state of Massachusetts, USA (from [5]).	23
2.10	Histograms and curve fittings of channel utilization.	25
2.11	Ideal SDR	26
2.12	A diagram of cognitive radio cycle.	27
2.13	A diagram of reinforcement learning.	30
2.14	An example of encoded parameters used in Genetic Algorithms.	31
2.15	A full cycle of case-based reasoning (from [6]).	32
2.16	A diagram of cooperative communication where radios share antennas to relay signals for others.	35
3.1	A conceptual view of a variety of vehicle communications.	39
3.2	An example of queueing model.	40

3.3	Vehicular dynamic spectrum access in TV bands lets vehicles access vacant TV channels.	42
3.4	Packet-based queueing model for VDSA in vacant UHF TV bands in the case where all vehicles have the same priority	43
3.5	Map, car density, and available channels along I-90 in the Commonwealth of Massachusetts in USA.	48
3.6	Predicted performance measures in the case when all cars are of the same priority. M/D/m model assumes deterministic service time, and M/M/m model assumes exponential service time.	49
3.7	Predicted performance measures in the case where cars have different priorities and same message rate of 60 msg/sec.	50
4.1	The architecture for applying intelligence in vehicular communications . . .	53
4.2	The adaptive learning-based channel selection process	57
4.3	Example of how channel values are learned. (a) Spectrum, (b) Channel “OFF” time percentages, (c) Channel value vectors at different time steps (n).	58
4.4	A snapshot of simulated scenario where TV broadcaster, IEEE 802.22 WRAN, and WLANs geographically share UHF TV spectrum.	60
4.5	An example of coexistence between frame-based PHY and contention-based PHY.	61
4.6	Performance comparison of three channel selection approaches in terms of (a) normalized throughput and (b) average switching times.	64
4.7	CDF of achieved throughput. μ is the average number of car groups in each direction/km.	65
5.1	A diagram of cooperative communication where radios share antennas to relay signals for others.	68
5.2	System model of spectrum sharing among primary user and secondary user groups	69
5.3	The change in outage probability if potential relays in the cooperating group have perfect knowledge of the channel condition toward the relay in a slow fading channel	78
5.4	The arrows here indicate change of outage probabilities when there is a total power consumption limit on the transmission of each message in addition to output power limit on each device. In the “Same power” scenario, the total power spent on each message by all relays in ODF is constrained to be no more than that of direct transmission, while in the “Full power” scenario relays are allowed to use their full power to forward a message.	80
5.5	Outage probabilities of the cooperating group using ODF and the non-cooperating group with different number of transmissions	81
5.6	Outage probabilities of the cooperating group using ODF and the non-cooperating group when the primary user transmission powers increase (from [7]). Each group has 10 users and channels are assumed to be fast fading.	82

5.7	The average numbers of active surviving users from the competition of channel access in a slow fading channel. A user quits on receiving 10 or more instances of outage in the nearest past 20 transmission attempts.	83
6.1	A vehicular dynamic spectrum access scenario where vehicles coexist with other wireless networks along the road.	86
6.2	The system diagram of a node implementation for the testbed. The radio subsystem is implemented using a Gateworks board, and the UI subsystem is implemented on a PC.	87
6.3	Hardware of the radio subsystem.	88
6.4	Snapshots of tables in the context database. (a) Location table. (b) AP table. (c) Channel utilization table.	90
6.5	Distribution of APs over channels at different locations. The sizes of circles indicate numbers of APs per channel. The maximal number of scanned APs per channel is 30.	91
6.6	Measurements of received bytes and channel busy time. (a) Raw measurements. (b) Data filtered through a moving average of 20 samples.	92
6.7	GPS track of a channel measurement test starting from near Central Exp on the right, via Mountain View on the left, and back to Central Exp.	95
6.8	Optional caption for list of figures	96
6.9	Channel switching protocol for a wireless ad hoc link.	97
6.10	Measurement of channel switching operation over a wireless ad hoc link.	98
6.11	Expected channel selection outcome.	99
6.12	Process flowchart of the channel adaptation test.	99
6.13	A sample result of a roadtest demonstrating dynamic channel selection. (a) Line plot of channel measurements. (b) Image plot of channel measurements. Line of channel selection shows how it avoids high interference.	102
6.14	Performance comparison of round trip latency using ping between using a static channel and using dynamic channel selection during a road test. Static channel experiences higher packet latency due to interference from local WiFi networks, while dynamic channel selection can help avoid such interference.	103
A.1	TV Channel availability at different locations along I-90 in the state of Massachusetts, USA (from [5]).	107
A.2	Queueing analysis tool based on MATLAB GUI for capacity of using TVWS for vehicle communications	108
B.1	Experiment setup of the VDSA simulator.	109
B.2	RSSI in both time and frequency domains.	110
B.3	NED model of a multi-mode car used in the simulator	111
B.4	A VDSA simulator based on OMNeT++.	111

List of Tables

2.1	Some problems in cognitive radio that are solved by classic machine learning approaches.	30
4.1	Simulation parameters for creating artificial WRANs and WLANs.	63
6.1	Correlation values between channel measurements.	93
6.2	Feature comparison between <i>ath5k</i> driver and <i>MadWifi</i> driver.	93

Acronyms

AI Artificial Intelligence

AF Amplify-and-Forward

AWGN Additive White Gaussian Noise

CBR Case-Based Reasoning

CDF Cumulative Distribution Function

CR Cognitive Radio

CRS Cognitive Radio System

CSMA Carrier Sense Multiple Access

DF Decode-and-Forward

DT Direct Transmission

DSA Dynamic Spectrum Access

DSRC Dedicated Short Range Communications

ERP Effective Radiated Power

EIRP Equivalent Isotropically Radiated Power

FCC Federal Communications Commission

ISM Industrial, Scientific and Medical

LTE 3GPP Long Term Evolution

MAC Medium Access Control

MAI Multiple Access Interference

MC-CDMA Multicode Code Division Multiple Access

MIMO Multiple Input Multiple Output

ODF Opportunistic Decode-and-Forward

PDF Probability Distribution Function

PN Pseudorandom Noise

QoS Quality of Service

RF Radio Frequency

SDR Software Defined Radio

SNR Signal-to-Noise Ratio

TVWS TV whitespace

TVBD TV Band Device

VANET Vehicle Ad Hoc Network

VDSA Vehicular Dynamic Spectrum Access

V2V Vehicle-to-vehicle

V2R Vehicle-to-Roadside

V2I Vehicle-to-Infrastructure

Chapter 1

Introduction

1.1 Motivation

The Google driverless car [8] has received a significant amount of attention and enthusiasm from both the technology and policy communities. The current model of the Google driverless car is equipped with video cameras inside the car, a light detection and ranging (LIDAR) sensor on top of the vehicle, radar sensors on the front of the vehicle and a position estimation system. Properly programmed, the vehicle can drive itself safely, avoiding crashes and even achieving high fuel efficiency. While the Google driverless car represents the latest technologies of independent self-driving vehicles that may fundamentally change the vehicle industry, car manufacturers have followed a more conservative path toward automated driving. Over the past decade, car manufacturers have developed features such as autonomous cruise control system and lane departure warning system/lane keeping system to gradually transform people's traveling experience.

From a larger perspective, the community is looking at intelligent transportation systems (ITS) to improve safety and efficiency of physically limited road systems. For example, a car platooning system in Figure 1.2 enabled cars to form a group and travel compactly together relying on automatic coordination among cars without mandating human operation. As a result, road congestion can be relieved due to more efficient use of road surface, and accidents due to human error can be avoided. Unlike the other features of cars that can be independently equipped on individual vehicles, ITS focuses on coordination between cars and the infrastructure, as well as between the cars themselves, which requires reliable and capable wireless vehicular communication. The primary goal of vehicle communications is not to completely eliminate the role of drivers, but to enhance the driver's and passengers'

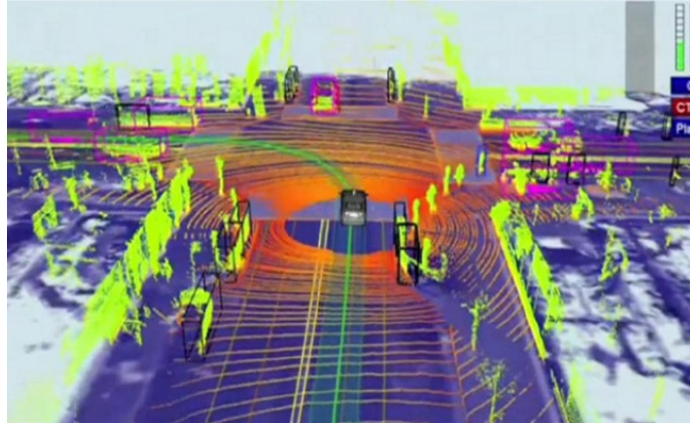

Figure 1.1: Google's driverless car using LIDAR to detect environment [1].



Figure 1.2: A car platoon experiment by PATH[2].

experience by introducing communication capabilities to the vehicle so as to provide better infotainment services and enhance road safety and efficiency.

The development of wireless communication in order to enable machines to exchange information with each other without encountering many of the constraints imposed by man-made transmission mediums, such as wires and optic fibers, not only avoids the difficulty of deploying transmission facility in undesirable environments or over long distances, but also alleviates the burden of maintaining physical connections between communication devices and provides machines as well as users with the freedom of mobility. The inherent downside of wireless communications is closely related to its upside. All users within transmission range share the same wireless transmission medium limits the share allocated to each in-

dividual user, whereas the wired transmission medium is only shared among a controlled number of machines and users.

The wireless transmission medium is quantized using a concept of *radio frequency spectrum*, which encompass electromagnetic waves of frequencies shown in Figure 1.3. The portion of radio frequency spectrum that is suitable for wireless communication is limited to only a portion of that shown in Figure 1.3. The higher the frequency, the more difficult it is for wireless signals to propagate around obstacles. Frequencies higher than 10 GHz are generally regarded as not suitable for long-range wireless communications, such as cellular networks and mobile ad hoc networks.

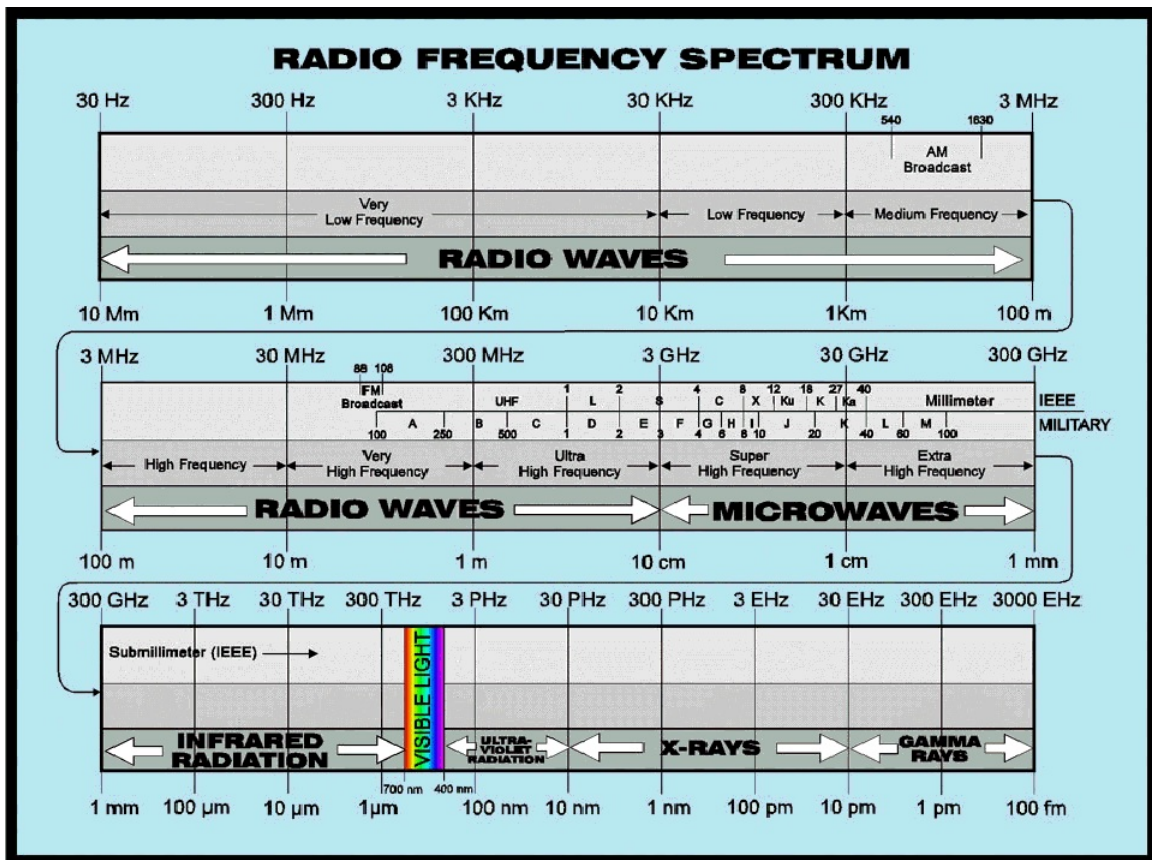

Figure 1.3: Electromagnetic wave spectrum from 30 Hz to Gamma rays. (from [3])

The limited amount of frequency spectrum bands was not a problem until the advancement of semiconductor technology made wireless communication devices relatively inexpensive and portable such that everyone could carry around one or more these devices such as

cell phones and laptops. In the past, when a more limited number of people used communication devices consuming spectrum slices, spectrum was generously allocated to whoever asked for it. Such allocations are regulated by federal governments and it is becoming increasingly difficult to change the spectrum allocation map as more devices are manufactured using a model specially designed for the old spectrum allocation. As a result, we now face a situation where spectrum usage is extremely unbalanced across several frequency bands, as observed by studies conducted by the FCC Spectrum Policy Task Force that report vast temporal and geographic variations in the usage of allocated spectrum [9]. In order to more efficiently use the under-utilized spectrum bands, the FCC has issued a Notice of Proposed Rule Making [10] advancing Cognitive Radio (CR) technology as a candidate to implement negotiated or opportunistic spectrum sharing.

We can trace the history of the term “cognitive radio” back to 1998 when Dr. Mitola first coined the term [11]. Some forms of adaptive radios [12] appeared before that time that possessed the capability of cognition to some extent. Many researchers have had their explanations of “Cognitive radio” and made various assumptions based on their understanding of the term and its working environments. Depending on the application field, cognitive radios are constrained in different aspects. In the early years, cognitive radios were primarily limited by hardware capability, such as the data rate of A/D and D/A converters, linear range of power amplifiers, and the computing power. Power consumption is widely recognized as a major problem whenever employing advanced functions. Recently, “green communication” re-emphasizes the energy efficiency of telecommunication [13]. The high cost of introducing cognition to products with large-scale manufacturing is also a concern. For example, wireless sensor networks require compact, power efficient, cheap, and reliable radio devices. Personal communication devices must be compact, power efficient, and reliable, but not necessarily cheap. Satellite devices can be expensive but have strict power and size constraint. The required cognitive capability depends on the intended user group.

The development of cognitive radios needs applications that have less hardware constraints and a large consumer market in order to gain popularity. Vehicle communications is one such area that fits the desired profile. Vehicle communication devices can have continuous power supply and relaxed size constraint, but need to be highly reliable to minimize the need of maintenance. The transportation system in the United States has been said to be outdated with very few new roads constructed in recent years [14]. Roads were not designed for today’s high speed modern vehicles and the large volume of passenger vehicles. As a result, safety and road efficiency become two issues that need better solutions.

Intelligent transportation systems [15] is therefore proposed for such applications.

At the same time, automotive industry also needs a major technical advancement in the Information Age. In the United States, vehicles have become a common, if not necessary, consumer product. Most advances are with the information devices and peripherals, while the power train and other conventional components of a typical car have not changed much in decades. Major vehicle manufacturers are investing in the driver experience in order to attract buyers. However, there has not been a functional enhancement that is deemed revolutionary by the general customers. Fast development in information technology, an increasing amount of people are accessing the Internet and the accompanying services. This also brings up an upgrading opportunity in the vehicle industry. With fixed WiFi hotspots deployed everywhere, people could have broadband Internet access throughout the day at any place but not when traveling in a car.

1.2 Current State-of-the-Art

The problem of vehicle communications requires a top-down system level perspective. One needs to consider the legacy communication infrastructure, the relations among vehicle density, user demands, and available wireless spectrum, as well as a variety of forms of vehicle network for different applications. A challenge for both enhancing road safety and improving road efficiency is the demand of extensive inter-vehicle communications. Connectivity alone does not suffice and reliable communication with short delays are required due to the high traveling speeds of vehicles. Network changes and accidents can happen within tens of milliseconds such that information and messages among vehicles have short lifespans.

The most significant problem in vehicle communications is the highly mobile operating environment, which makes it difficult to deploy base stations to provide wireless services, such as Internet access, which is infrastructure-based by nature since nearly all services follow a client-server paradigm. Peer-to-peer distributed ad hoc networks do not have this constraint. The vehicle ad hoc networks (VANET) are usually treated as a separate topic from generic ad hoc networks due to many characteristics that distinguish such networks from others, such as the special mobility pattern, the varying vehicle density, and interference with other types of networks. Many efforts have been made trying to create practical applications of VANETs.

Dedicated Short Range Communications (DSRC) [16] is a type of wireless communi-

1.2. CURRENT STATE-OF-THE-ART

cations specially designed for vehicles. In North America, 75 MHz at 5.850-5.925 GHz was allocated to the mobile service in 1999 for use by DSRC [17]. A group of standards related to all layers of protocols for DSRC-based operation was proposed including IEEE 802.11p WAVE, which stands for Wireless Access in Vehicular Environments [18]. The WAVE protocol stack is based on the IEEE 802.11a wireless LAN standard; both are designed for short range communications less than 500 meters. The existing standards are still under investigation and their performance in dynamic road environments are yet to be assessed. Moreover, since several standardizing groups across the world are working on similar applications, whether a general set of protocols can work internationally is unknown. Furthermore, short-range communication protocols may not be able to provide acceptable Internet connectivity especially for vehicles moving at high speeds.

Another challenge for vehicle communications is the bandwidth scarcity. The trend of development in wireless communication has always been accompanied by the gradually increasing demand of spectrum. The larger the customer population, the larger the demand. Examples include wired networks, cellular networks, wireless local networks, as well as broadcast systems. In Figure 1.3, both the cellular bands and ISM bands are highly congested due to large consumer population. Similarly, vehicle networks would face the same issue when the application is provided to a large customer population. Compared to other forms of networks, it is even more difficult to allocate dedicated spectrum bands to vehicle communications due to reasons including: (1) car manufacturers will not buy spectrum, (2) spectrum bands need to be allocated for a whole state or several states to enable radio devices of long-distance traveling vehicles to function without interruption, (3) vehicle networks need spectrum bands at lower frequency to combat Doppler effects and extend transmission ranges.

Several major automobile manufacturers have added connectivity features into their vehicles. Several examples of connectivity features for vehicles are WiFi connection to APs for Internet connection when vehicles are not moving in high speeds and subscription to cellular networks that provides highly mobile voice and data connections. These technologies connect vehicles to the backhaul and open a wide range of opportunity of application relying on Internet connectivity. This approach, however, suffers from two limits: the congestion of cellular spectrum in large cities and the absence of cellular coverage in rural areas. At this moment, there are not any applications provided for inter-vehicle communications.

1.3 Research Contribution

Based on the understanding of the state-of-the-art of integrating transportation vehicles and wireless communications, this dissertation presents a novel vehicular dynamic spectrum access approaches and vehicular cooperative communication schemes with the goal of achieving intelligent transportation systems. VDSA combines the advantages of dynamic spectrum access to achieve higher spectrum efficiency and the special mobility pattern of vehicle fleets. This dissertation will provide a new feasibility analysis within a TV whitespace environment, a framework for optimizing VDSA via artificial intelligence and learning, as well as simulation testbeds that reflect realistic spectrum sharing scenarios between vehicle networks and heterogeneous wireless networks including wireless local area networks and wireless regional area networks. Detailed experimental results justify the testbed for emulating a mobile dynamic spectrum access environment composed of heterogeneous networks with four dimensional interference. More importantly, numerical results show the performance improvement of adaptation and learning with respect to some practical applications in vehicle communications.

Vehicular cooperative communication is the other proposed technique that combines the cooperative communication technology and vehicle platooning, an emerging concept that is expected to both increase highway utilization and enhance both driver experience and safety. This dissertation will focus on the coexistence of multiple vehicle groups in shared spectrum, where intra-group cooperation and inter-group competition are investigated in the aspect of channel access.

The novel contributions of this dissertation with respect to the research community are:

- Quantitative characterization and analysis of channel capacity in a VDSA environment [19, 20] (Chapter 3). A queueing theory model is used to analyze the upper bound of communication performance metrics at different locations given the number of available channels, the number of users, and the traffic intensity of wireless communications. This approach is then applied for inspecting the TV whitespace along interstate highway I-90 in the commonwealth of Massachusetts.
- Learning architecture for a VDSA-enabled wireless transceiver and learning-based dynamic channel selection methods for real-world mobile vehicles [21, 22, 23] (Chapter 4). A cognitive radio architecture is designed to combine short-term adaptation and long-term learning into a unified approach for intelligent vehicle communication systems. Using this architecture, a novel feature of dynamic channel selection is designed for

mobile vehicles, such as public transportation and commuting cars. This feature enables mobile users to avoid interference with other spectrum incumbents or secondary users in order to obtain better link qualities in a mobile dynamic environment.

- A hardware testbed is developed to implement and demonstrate the above system (Chapter 6). The testbed is based on regular Linux wireless drivers and off-the-shelf WiFi radios. Key features include channel utilization measurement, dynamic channel selection, and channel hopping coordination protocol between transceivers. The testbed is also experimented and validated in the mobile environment of passenger vehicles.
- Analysis of the competition for spectrum access between secondary user groups that can choose to employ cooperative communication or not [7] (Chapter 5). In light of the emerging technologies of intelligent transportation system and platooning cars, this analysis provide insights on how car groups could utilize cooperative communication technology to enhance link qualities as well as compete with other users for spectrum access.

Over the past few years, the following publications revolving the idea of VDSA were provided to the community. Below they are listed with corresponding citation numbers used in this dissertation.

List of Journal Articles

2. **Si Chen**, A.M. Wyglinski, R. Vuyyuru, O. Altintas, and S. Pagadarai, “*Feasibility Analysis of Vehicular Dynamic Spectrum Access via Queueing Theory Model*,” IEEE Communications Magazine Automotive Networking Series, November 2011, [20]
1. **Si Chen** and A.M. Wyglinski, “*Efficient Spectrum Utilization via Cross-Layer Optimization in Distributed Cognitive Radio Networks*,” Elsevier Computer Communications Journal, 2009, [24]

List of Conference Papers

9. Sean Rocke, **Si Chen**, R. Vuyyuru, O. Altintas, and A. M. Wyglinski, “*Knowledge-based Dynamic Channel Selection in Vehicular Networks*,” IEEE Vehicular Networking Conference (VNC), 2012, [25]

1.3. RESEARCH CONTRIBUTION

8. **Si Chen**, R. Vuyyuru, A.M. Wyglinski, and O. Altintas, “*Evaluation of Learning-Based VDSA Networks in Multiple Secondary Spectrum Access Network Environments*,” IEEE 76th Vehicular Technology Conference (VTC2012-Fall), 2012, [23]
7. **Si Chen**, R. Vuyyuru, O. Altintas, and A.M. Wyglinski, “*Learning in Vehicular Dynamic Spectrum Access Networks: Opportunities and Challenges*,” International Symposium on Intelligent Signal Processing and Communication Systems (ISPACS), 2011, [22]
6. **Si Chen**, R. Vuyyuru, O. Altintas, and A.M. Wyglinski, “*On Optimizing Vehicular Dynamic Spectrum Access Networks: Automation and Learning in Mobile Wireless Environments*,” IEEE Vehicular Networking Conference 2011, (IEEE VNC 2011) [21]
5. **Si Chen**, C. Ghosh, A.M. Wyglinski and S. Jayaweera “*Impact of Group Cooperation over Competitive Secondary Subnetworks*,” The 2011 IEEE Pacific Rim Conference on Communications, Computers and Signal Processing (**Gold Award** for Best Communications Paper), [7]
4. **Si Chen**, T. Newman and J. Evans and A.M. Wyglinski, “*Genetic Algorithm-based Optimization for Cognitive Radio Networks*,” IEEE Sarnoff Symposium, 2010, [26]
3. **Si Chen** and A.M. Wyglinski, “*Cognitive radio-enabled distributed cross-layer optimization via genetic algorithms*,” 4th International Conference on Cognitive Radio Oriented Wireless Networks and Communications (CROWNCOM), 2009, [27]
2. C. Ghosh, **Si Chen**, D.P Agrawal, A.M. Wyglinski, “*Priority-based spectrum allocation for cognitive radio networks employing NC-OFDM transmission*,” IEEE Military Communications Conference (MILCOM), 2009, [28]
1. **Si Chen** and A.M. Wyglinski, “*Distributed Optimization of Cognitive Radios Employed in Dynamic Spectrum Access Networks*,” Proceedings of SECON 2008 - Workshop on Software Defined Radio (San Francisco, CA, USA), Jun 2008, [29]

List of Papers in Preparation

2. **Si Chen**, C. Ghosh, A.M. Wyglinski and S. Jayaweera, “The Impact of Intra-group Cooperation on Competitive CDMA-based Secondary Subnetworks in Opportunistic Spectrum Access”,

1. **Si Chen**, Timothy Menard, Jonathan Landon, and Rama Vuyyuru “Vehicular Context-aware Multiband Testbed for Dynamic Radio Reconfiguration”.

1.4 Dissertation Organization

This dissertation is organized as shown in Figure 1.4. Chapter 2 covers the related background knowledge for this thesis, which includes several surveys of topics such as vehicle communications, software defined radios, and distributed artificial intelligence. Chapter 3 proposes the general concept of VDSA and the demonstration of feasibility from several aspects. Chapter 4 and 5 dive into two specific techniques that can boost the performance vehicles conducting VDSA. In Chapter 6, the concept and architecture of VDSA is taken to the stage of real-world implementation by bringing up a vehicular context-aware multimode testbed. Finally, Chapter 7 concludes this dissertation.

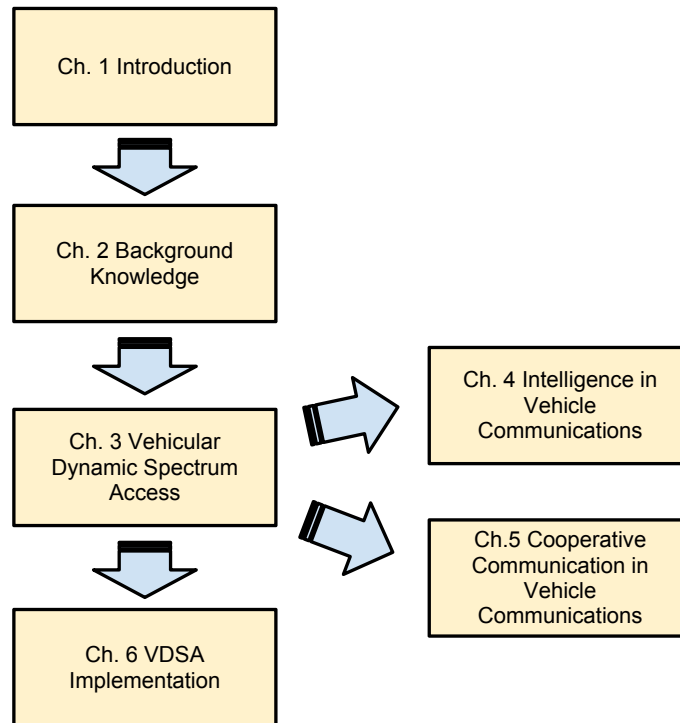

Figure 1.4: Dissertation Organization.

Chapter 2

Background Knowledge of Vehicle Communications and Cognitive Radio

This chapter provides an overview on several subjects that are relevant to this dissertation, namely cognitive system for vehicular communications. The goal is to bridge the gap between vehicular communication from the point-of-view of the automotive industry and the more broader field of wireless communication.

2.1 Vehicle Communications

The powertrain of vehicles has not changed much in over a decade, while an ever-increasing number of electronic parts, such as CPUs and sensors, are being installed into modern vehicles in order to improve the vehicle performance that is difficult or impossible via pure mechanic designs. Taking passenger vehicles as an example, car manufacturers are advertising the integration of high tech peripherals and accessories to new cars. Although some old-fashion car-lovers will consider these accessories as unnecessary eye-candy, most common customers who view cars as daily commodities enjoy these extra elements in car designs aimed for passenger comfort and safety. Figure 2.1 shows some examples of the extra utilities of modern vehicles. GPS and navigation systems make it easy for drivers to explore unfamiliar terrain; environment-awareness prevents car collisions; cell phone integration allow drivers to use phone functions seamlessly via operating vehicles; vehicle communications extend drivers' awareness of the surrounding to hundreds of meters in any

2.1. VEHICLE COMMUNICATIONS

direction.

There is a trend that consumer mobile communication devices are integrating multiple means of accessing different frequency bands and multiple wireless services, such as cellular voice services, data services, Internet services, personal area networks, and wireless local area networks. Furthermore, a vehicle has the potential of integrating wireless access systems relative to a personal communication device or serve as an omnipotent peripheral device when integrating with personal devices such as cell phones. The high demand of wireless services has resulted in more open and flexible frequency regulation. It can be expected that adaptive channel selection will become crucial in future wireless networks.



Figure 2.1: Some popular capabilities of modern vehicles.

The idea of inter vehicle communications is receiving increasing attention over the past decade. In addition to the 5.9 GHz band allocated for DSRC in U.S. and Europe and the 5.8 GHz in Japan, there is new interest in vehicular-based communications in the 700 MHz band. Japan has allocated 10 MHz in 700 MHz band for intelligent transportation system

available from July 2012 [34]. Radio waves in 700 MHz bands can propagate more easily through obstacles, hence are more suitable for vehicle-to-vehicle communications [35], such as intersection warning, while radio waves in 5.8 GHz or 5.9 GHz are good for short range communications, such as highway toll collection.

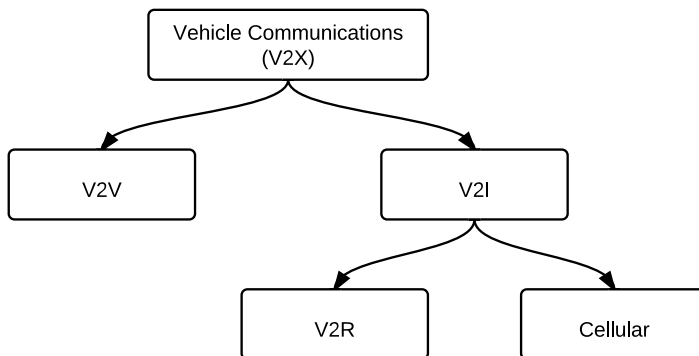

Figure 2.2: Types of cooperative vehicular communications and networks.

Vehicular communications can be categorized into Vehicle-to-Vehicle (V2V), Vehicle-to-Roadside (V2R) and Vehicle-to-Infrastructure (V2I). Applications utilizing vehicular communications will most likely be using the services of a complement of two or more of these categories. Of these, V2V scenarios are more challenging in comparison to V2R and V2I scenarios. V2I communications are usually implemented using cellular networks and cellular network operators are continuously improving the network capacity. The current deployment of V2R communications are mostly short-distance one-to-one communications such as toll collection. On the other hand, V2V communications are primarily ad hoc communications whose transmission ranges can vary from several meters to several hundreds of meters.

For example, below are a few applications that require V2V communications:

- A vehicle platoon is a group of vehicle traveling together as shown in Figure 2.3. A very successful demo of vehicle platooning was presented by the California Partners for Advanced Transit and Highways (PATH) project [2] in 1997. Recently, the Safe Road Trains for the Environment (SARTRE) project [36], successfully tested vehicle platoons during 2011. Although V2V communications were not used in vehicle platoons yet, great potential remains. With V2V communications, coordination across the whole platoon can be enabled to increase stability and robustness; infotainment data sharing among queued vehicles can enhance passenger experience and create pos-

2.1. VEHICLE COMMUNICATIONS

sibilities for innovative services. For V2I communications, a vehicle platoon can form antenna array to boost its connectivity to road-side base stations.

- A community-based road condition sharing service, a form of participatory sensing, needs a means of broadcasting user generated data to vehicles in the surrounding region with short delay to ensure the timeliness of information. Current services, such as Waze [37], are implemented via Internet connection provided by cellular networks, which introduces the delay of routing through backhaul and the security concern of location privacy.



(a) The 8 car platoon demo of PATH project (from [2]).

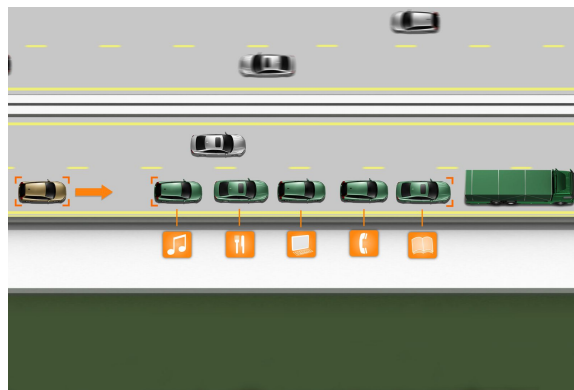

(b) The vision of SARTRE project's road train (from [36]).

Figure 2.3: Road test and simulation demonstration of vehicle platooning.

The number of vehicles possessing the ability to perform wireless communications is only a small fraction of the total market, and the spectral bandwidth requirements of these

wireless-enabled vehicles is relatively low. Nevertheless, it is anticipated that the level of V2V and V2I information exchanges enabled by wireless communications will significantly increase in the near future due to a growing number of wireless-enabled vehicles, vehicular communication applications/standards, and high data rate traffic flows. Although it is still too early to say whether DSRC is sufficient for the growing demand for V2V applications, we envision that it would be very difficult to obtain additional licenses for spectrum dedicated specifically for vehicle communications. Consequently, the spectrum scarcity issue currently experienced by several other sectors in modern society will soon affect the automotive industry (see Section 2.2). Thus, innovative techniques are required to counteract the spectrum scarcity issue within vehicular communication networks and enable more efficient usage of RF spectrum.

One solution for accommodating this growing demand is a derivative of DSA, referred to as *vehicular dynamic spectrum access* (VDSA), where vehicular wireless communication systems can temporarily borrow unoccupied RF spectrum while simultaneously respecting the rights of the incumbent licensed transmissions [5]. We proposed the use of dynamic spectrum access as a possible option for certain types of vehicle communications [21]. It is reported that an average commuter in the United States drives approximately 26 km per day. Even for TV spectrum bands, which is characterized as having a stationary spectrum utilization across large distances, e.g., 100 km, the spectrum occupancy characteristics throughout the journey will probably not be invariant.

2.1.1 Challenges and State-of-the-Art

The challenges of implementing vehicle communications and the current development in the frontiers are described as follows.

Distributed Ad hoc Coordination: One central challenge for vehicle communications, especially V2V communications, is that, similar to other ad hoc networks, inter-vehicle networks can hardly rely on any communication coordinators. Although V2I communications involve roadside infrastructure by design and can rely on those fixed roadside units to serve as coordinators, V2V communications are expected to function with or without roadside assisting units. Consequently, Hartenstein claimed in [38] that since no central coordination or handshaking protocol can be assumed, and given that many applications will be broadcasting information of interest to many surrounding cars, the necessity of a single, shared control channel can be derived (even when multiple channels are available

using one or more transceivers, at least one shared control channel is required). He stressed a one-channel paradigm for V2V communications.

The one-channel paradigm, coupled with hidden terminal problem, present harsh requirements on the medium access control (MAC) protocol design in V2V communications. At this moment, the main focus is on IEEE 802.11 carrier sense multiple access (CSMA)-based MAC for V2V communications due to concerns of cost and ease of implementation. Such contention based MAC, although robust and easily deployed, is well known for not performing well under high customer intensity. The bandwidth of the frequency channels currently assigned or foreseen for vehicle communications ranges is 10 MHz without channel overlapping. With a high vehicular traffic density, those channels could suffer from channel congestion, especially when accidents happen and cause message outbursts.

To balance the need of instantly sharing message among all vehicles and reducing congestion on common control channels, many researchers have considered making use of multiple channels. The current mainstream approach is to let all vehicles synchronize to a global time reference and switch between a common control channel and separate service channels every 100 ms. This approach has been widely criticized to be inefficient. Consequently, multiple antenna may be the way to go given the large size of a regular vehicle.

Mobility: Other challenges are the dynamic network topology based on the mobility of the vehicles and the environmental impact on the radio propagation. The latter must take into account that the low antenna heights and the attenuation/reflection of all the moving metal vehicle bodies provides for adverse radio channel conditions. All together, VANETs must work properly in a wide range of conditions, including sparse and dense vehicular traffic. There is a strong need for adaptive transmit power and rate control to achieve a reasonable degree of reliable and low latency communication.

Interference: When vehicles belonging to different transmission sets but using the same portion of spectrum approach each other at high speed, their transmissions will interfere with each other. One approach to solve this is to make the sensing area larger than the transmission area, such that vehicles can “see” other vehicles coming transmitting in the same portion of spectrum and take actions to avoid interference. Both the optimal sensing range and optimal transmission range are hence dependent on the vehicle speed. Note that the varying in spectrum availability should not have an impact on the drivers’ experience. So the problem of finding the optimal relation between sensing/transmission ranges and the speeds of vehicles can be experimented using a simple network simulator running on

real-time car moving traces.

Experiment Platforms: The hardware experiment platforms of vehicle communications usually consist of regular vehicles and software-defined radios [39, 40]. Platforms with vehicle mechanics and radios integrated together, although exciting, are hard to come by, even at a small quantity.



Figure 2.4: A screenshot of Veins [4] simulator suit for vehicle communications.

It is relatively advanced on the software side. Simulators combining vehicle mobility and communication networks are made possible by connecting traffic simulators such as SUMO [41] and network simulators such as NS-2/3 and OMNeT++ [42]. One example is Veins as shown in Figure 2.4. However, network simulators are commonly not strong at modeling the physical and MAC layer; the level of detail only go as far as packets or messages. Consequently, when modeling the changing topology of a environment composed of vehicle networks and local wireless networks, one can hardly find any suitable tools with the necessary accuracy of physical layer characteristics such as power spectral density, wireless interference level, and Doppler effects.

2.2 Spectrum Scarcity

As the demand for high speed wireless transmission increases, in both industries and personal communication systems, researchers have tried to seek possibilities in all areas throughout the communication system. Recent measurements showed that the wireless spectrum resource in terms of frequency and time is underutilized in most part of the whole spectrum and overutilized in a few sections, such as the cell phone band and the industrial, scientific and medical (ISM) radio band. According to the *Federal Communications Commission* (FCC) [43], temporal and geographical utilization of the assigned spectrum varies from 15% to 85%. Spectrum measurements are also at [44, 45, 46]. For example, spectrum measurement [47] in Figure 2.5 shows significant imbalance of spectrum utilization.

The huge difference is the consequence of fixed spectrum regulation over almost the whole spectrum provided by the FCC or other regulators, under which every section of the spectrum is allocated for a particular use alone, and the user maintain exclusive rights across the specified range of frequencies within a geographical area. One of the reasons for fixed spectrum regulation is the incapability of conventional wireless transmitters to automatically change transmitting parameters. However, this is no longer the case as the techniques of software defined radios are getting mature, with the help of cheaper, faster, and smaller DSP units.

Software defined radio enables wireless platforms to autonomously choose device operating parameters. These wireless devices have the potential to revolutionize how society performs wireless networking. Furthermore, cognitive radios add cognition to software defined radio technologies so as to learn from the current wireless operating environment and explore more possibilities of efficient spectrum utilization.

Cognitive radio technologies can be used to improve spectrum access and efficiency of spectrum use in a variety of possible scenarios:

- A licensed user can employ cognitive radio technologies within its own network to increase the efficiency of use.
- Cognitive radio technologies can facilitate automated frequency coordination among several primary licensees. Such coordination could be done voluntarily by the licensees under more general coordination rules imposed by the FCC rules.
- Cognitive radio technologies can facilitate secondary markets in spectrum use, implemented by voluntary agreements between licensees and secondary users. For instance,

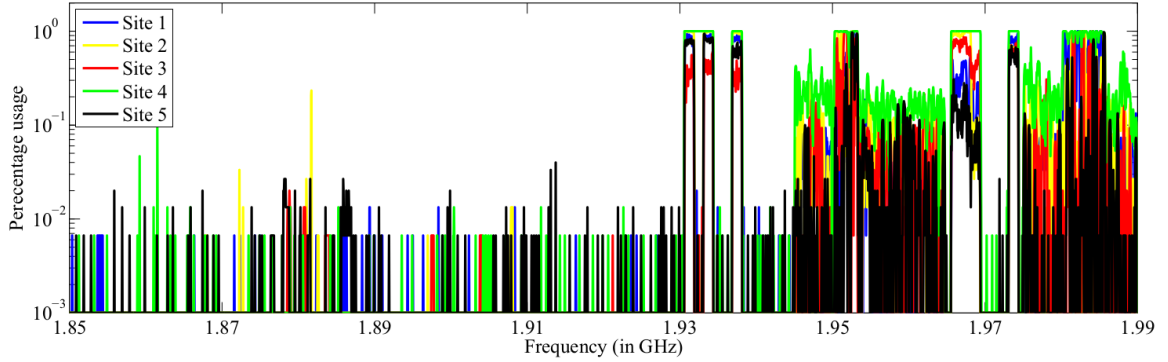

(a) Percentage usage of 40 kHz channels across five different locations in the PCS band (1850 MHz to 1990 MHz) in Rochester, NY on 06/19/2008.

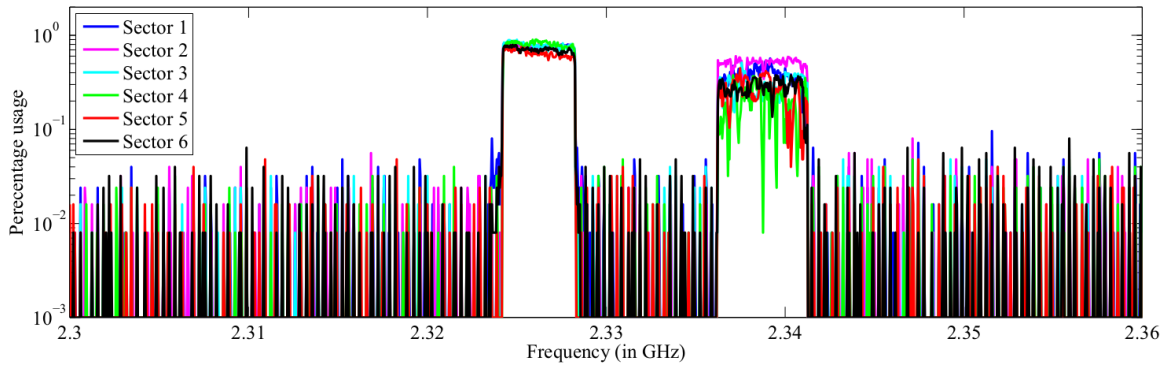

(b) Percentage usage of 40 kHz channels across six different sectors in the WCS band (2300 MHz to 2360 MHz) in Rochester, NY on 06/19/2008.

Figure 2.5: An example showing the spatial variation of spectrum usage.

a licensee and secondary users could sign an agreement allowing secondary spectrum uses given no interference on the licensee, which is made possible only by deployment of cognitive radio technologies. Ultimately cognitive radio devices could be developed to negotiate with a licensee and use spectrum only if agreement is reached between a device and the system.

- Cognitive radio technologies can coordinate secondary uses in either licensed or unlicensed spectrum bands. For instance, given the heterogeneity of primary uses, secondary users can form a sub-network in a cooperative way utilizing the idle wireless resources, or in a non-cooperative way for several secondary sub-networks to compete for available resources.

As a result, the FCC is considering relaxing the fixed spectrum regulation by adopting

the idea of “borrowing” spectrum, which means unlicensed users can use licensed bands when they are not used by licensed users, *i.e.*, as long as not to interfere with licensed users.

2.3 Spectrum Occupancy and Utilization

Radio frequency spectrum occupancy and utilization is a complex issue depending on multiple domains including space, time, and frequency. Since it is not the critical issue of this dissertation, here I only include a few perspectives of the issue, namely the VHF/UHF TV broadcast bands and the ISM bands. These two portions of spectrum bands are most widely studied for the implementation of flexible spectrum access.

2.3.1 Television Broadcast Channels

Currently, The TV broadcast frequencies used in North America are channel 2 through 13, namely 54 MHz to 216 MHz in VHF band, and channel 14 through 51 except 37, namely 470 MHz to 698 MHz in UHF band. Detailed information about U.S. TV band allocations can be found in the FCCs Consolidated DataBase System (CDBS), which can be accessed via the FCC TV Query website [48]. Each type of licensed incumbent system listed above has specific interference protection requirements. Each TV station has a commonly regulated protected service area that is determined by its Grade B Contour for analog broadcast operations or its Noise Limited Contour (NLC) for digital broadcast operations. TV station service contours are determined by a variety of CDBS station parameters, including effective radiated power (ERP), antenna pattern, antenna height above average terrain (HAAT), operating band/channel, and service type. These levels as proposed by the FCC and presented in [49, 50].

Before November 2008 [51], when the FCC authorized TV whitespace (TVWS) devices, also called TV Band Devices (TVBD), to use the television broadcast spectrum as unlicensed secondary users of the spectrum, VHF/UHF TV channels mostly used by TV broadcasting and in some places wireless microphones for sports venues or special events. In December 2011, the FCC approved the first TVWS device in Wilmington, North Carolina, U.S.A, which functions together with a database run by Spectrum Bridge to ensure it does not interfere with other usage. Furthermore, in January 2012, the approved devices were deployed.

Portable TVBDs are restricted to operate only at 100 mW of power output unless used

2.3. SPECTRUM OCCUPANCY AND UTILIZATION

on adjacent TV channels where their output is limited to 40 mW. In addition, portable devices are also prohibited from operating on channels 14 through 20, as well as 37, leaving only channel 21 through 51 except for channel 37 available for vehicular communications. Harrison *et al.* showed several methods to compute the capacity of TV white space in [52]. Previously in [5, 50], the authors presented a general geo-location database approach to create a spectral map of available channels, and the results along highway I-90 in the state of Massachusetts were obtained by characterizing the availability of vacant TV channels in the 470-806 MHz frequency range.

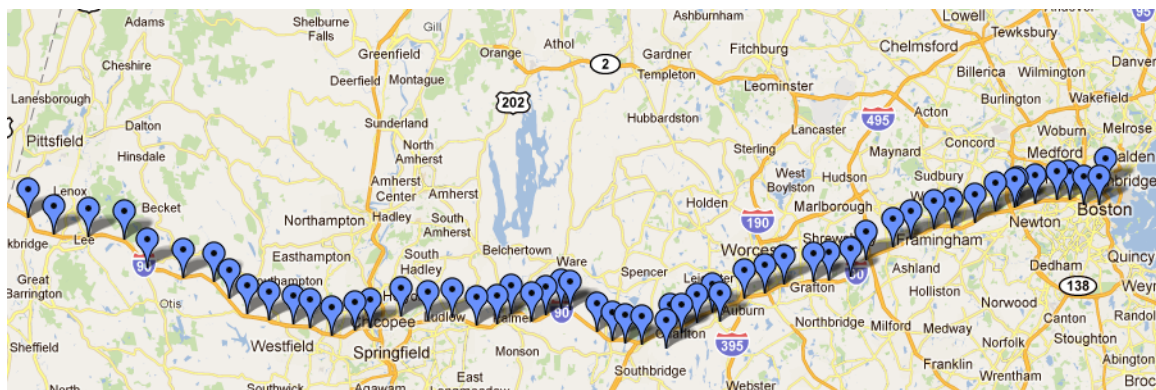

Figure 2.6: A map of the forty eight locations close to I-90 between Boston, MA and West Stockbridge, MA over which spectrum measurements were collected on June 7, 11, and 12, 2009 (from [5]).

A spectrum measurement campaign was conducted on June 7, 2009 and June 30, 2009 across 48 locations between Boston, MA and West Stockbridge, MA. Since the goal of the project is to characterize DTV spectrum over several locations on I-90 in the Commonwealth of Massachusetts, most sites were chosen to be within half mile from I-90 for the purpose of avoiding interference to the ongoing traffic. The western most point in our study was West Stockbridge, MA and the eastern most point was Boston, MA. As mentioned earlier, they selected 48 different locations close to I-90 with 10 sweeps per site.

Figure 2.7 shows the energy spectral density plot for the TV bands in the higher frequency range which is the region primarily identified as the suitable for dynamic spectrum access. An interesting thing to note is that, going farther away from Boston towards Palmer (which corresponds to a sweep index of around 220), the energy values decrease in general. However, going from Palmer towards West Stockbridge (which corresponds to a sweep index of around 120), the energy values show an increasing trend indicating that we were

2.3. SPECTRUM OCCUPANCY AND UTILIZATION

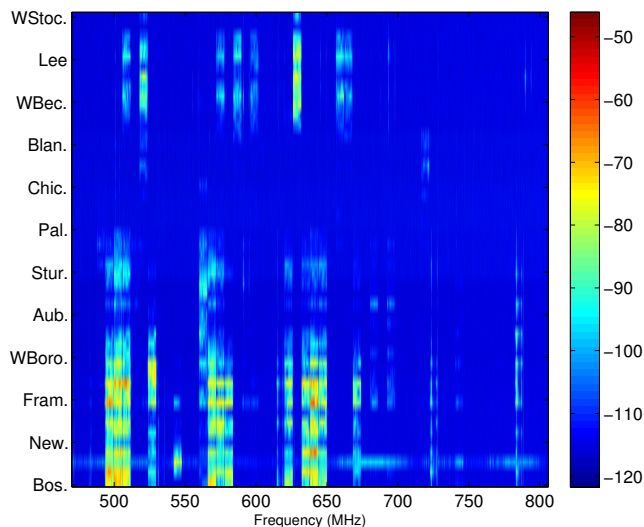

Figure 2.7: Energy Spectral Density plots for the TV frequencies in the higher frequency range *i.e.*, 470 806 MHz across 48 locations close to I-90 between Boston, MA and West Stockbridge, MA (from [5]).

approaching a nearby TV transmitter. Another observation from this figure is that there are several locations close to Boston, MA where we observe strong signals of the order of -50 dBm indicating that our measurement sites were close to TV transmitters. In Figure 2.8 are the data points collected on July 30, 2009, where the measurement setup was mounted on a moving vehicle travelling on I-90 at an average velocity of 60 miles/ hr. That is, instead of the entire UHF TV range, only 600 750 MHz were selected to achieve 4 sweeps per minute on average along the length of I-90. The total absence of any signal towards the end of our drive (around sweep index 520-530) was during the time when the moving vehicle was in the “Big Dig” of the Boston metropolitan area.

An algorithm was designed in [5] to convert the spectrum measurement data to channel availability taking into consideration the protected contour required by the FCC. A snapshot of the available channels across four different points is shown in Figure A.1. The white spaces in this figure indicate the vacant portions of the TV spectrum. As evident from this figure and as previously noted from Figure 2.7, the number of vacant channels in the western part of MA are more in number compared to the eastern part. It can be noted that the occupied/unoccupied regions appear as blocks of 6 MHz which is the bandwidth of a TV channel in the United States.

2.3. SPECTRUM OCCUPANCY AND UTILIZATION

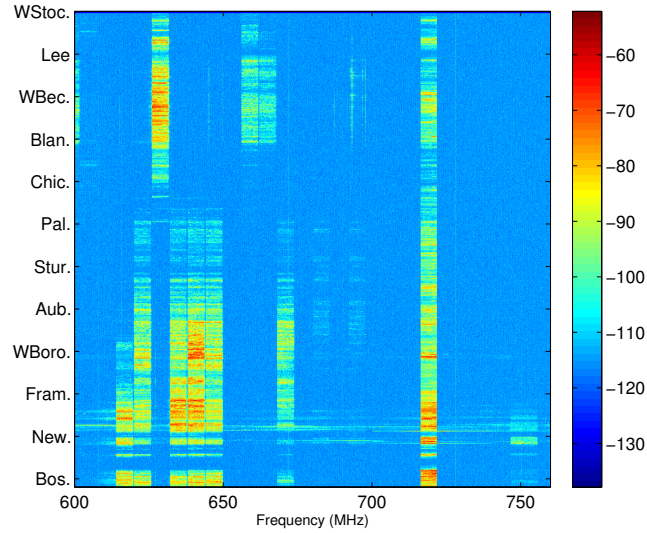

Figure 2.8: Energy Spectral Density plots for the TV frequencies in the frequency range, 600 750 MHz over 550 time sweeps close on I-90 between Boston, MA and West Stockbridge, MA. The measurement setup was located in a vehicle moving at an average velocity of 60 miles/hr (from [5]).

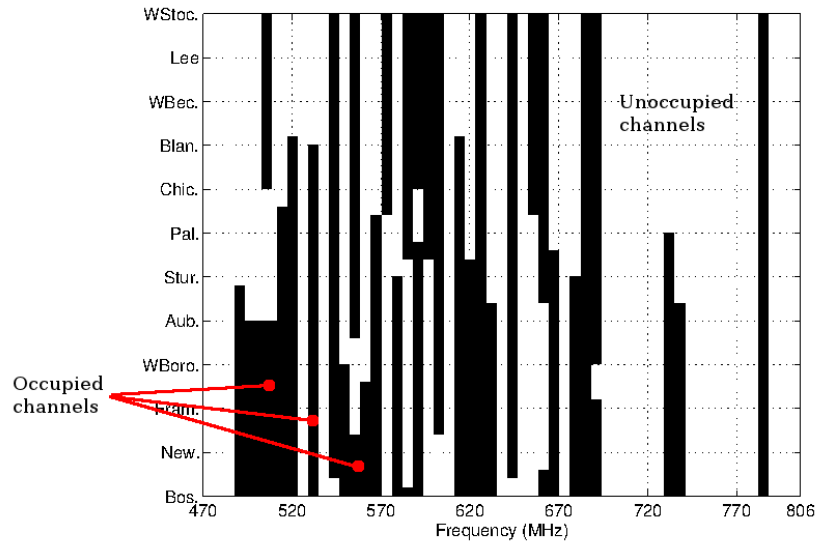

Figure 2.9: TV Channel availability at different locations along I-90 in the state of Massachusetts, USA (from [5]).

2.3. SPECTRUM OCCUPANCY AND UTILIZATION

A non-contiguous channel availability was observed as in Figure A.1. Thus an important requirement on the WSD transmitter, particularly for this non-contiguous case, is the means of communicating the channels used for data transmission. Since, potentially several non-contiguous channels could be used, the WSD-based MAC has to be tailored to accommodate the varying number and location of available TV channels. In order to do this, a spectrum sensing technique is needed that combines a geo-location database technique as outlined in this report with the traditional signal detection techniques to improve the detection threshold and meet the requirements imposed by regulatory authorities such as the FCC.

2.3.2 WiFi Channels

In contrast to TVWS, ISM bands are popular for short range communications with standards such as WiFi and Bluetooth. The FCC allows free access to the ISM bands with a maximum Equivalent isotropically radiated power (EIRP) of 36dBm (4 watts). One advantage of short range networks is the limited congestion and interference due to the small number of users within the maximum transmission range. Since 1985 when the FCC first released ISM bands for unlicensed use [53], WiFi has been a great success and is ever developing. The channel utilization of WiFi networks represents the typical channel utilization of unlicensed bands. Therefore, it is necessary to study the channel utilization of WiFi networks in order to predict how future unlicensed networks will look like.

Carrier Sensing Multiple Access with Collision Avoidance (CSMA/CA) is the most popular MAC scheme in WLANs and the channel utilization of WLANs has been well studied. The idle duration has been shown to follow exponential distribution [54] and the instant channel utilization shows a distribution resembling a normal distribution [55]. Figure 2.10 shows the probability density functions of a real WLAN channel in busy and less busy conditions. Log-logistic distribution was found to be a good candidate to model the channel utilization with 100 ms granularity for both busy and less busy conditions. When taking channel utilization measurements with 10 ms granularity, normal distribution seems to be a better fit than log-logistic distribution. Note that these measurements were taken on real WLANs. Thus, it can be expected that similar probability density distribution can be observed in future spectrum bands with shared contention-based multiple access.

Although the channel idle durations follow exponential distribution in WiFi networks, it would be a misled and vain attempt to use the same distribution assumption on channel idle time of primary users and then investigate the feasibility and performance of secondary time-domain channel access schemes. The reason is twofold: (1) the majority of the idle durations

2.3. SPECTRUM OCCUPANCY AND UTILIZATION

described by such distribution is below 5 ms, which is too short for any practical devices to detect and utilize, and (2) WiFi networks are contention-based, and contention-based MAC protocols are mostly used in unlicensed networks, where there are no differentiation between primary users and secondary users. Licensed networks, especially those with high traffic intensity, would not use contention-based MAC protocols because they yield lower channel utilization compared to channel-based MAC protocols such as TDMA and OFDMA.

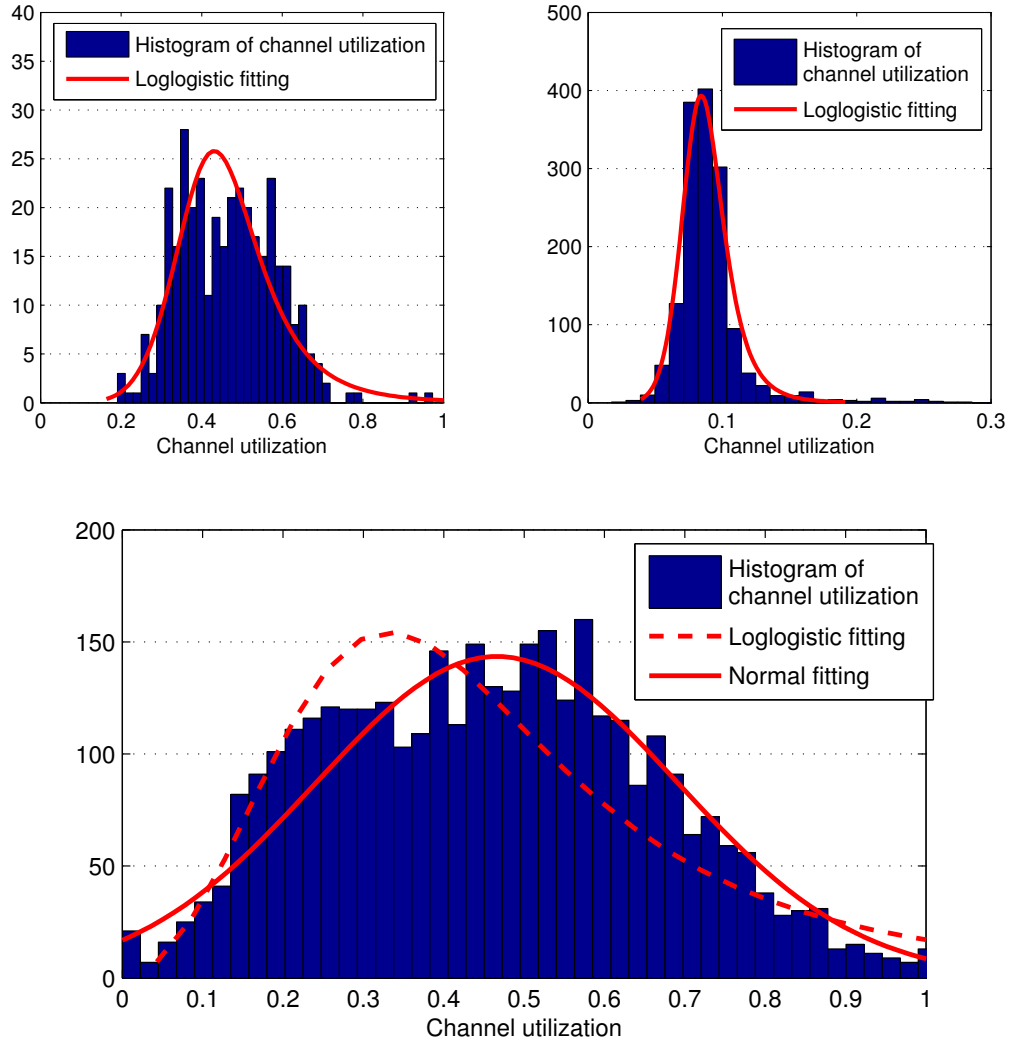

Figure 2.10: Histograms and curve fittings of channel utilization. (a) A busy channel with an accumulated throughput of 10 Mbps sampled at 100 ms granularity, (b) A less busy channel with an active connection of 1.5 Mbps sampled at 100 ms granularity, (c) A busy channel with an accumulated throughput of 10 Mbps sampled at 10 ms granularity.

2.4 Software Defined Radio and Cognitive Radio

Cognitive radio is the combination of flexibility of software defined radio and the capability of learning enabled by artificial intelligence or machine learning implemented in the upper layers or in a cross-layer fashion. Cognitive radio is considered in a sense as a goal towards which a software-defined radio platform should evolve: a fully reconfigurable wireless transceiver which automatically adapts its communication parameters to network, radio environment, and user demands. In order to improve the spectrum band utilization efficiency of rarely used frequency band specially assigned to specific services, regulatory bodies in the world have been considering to allow unlicensed users to use licensed bands if they would not cause any noticeable interference to licensed users. These initiatives have focused cognitive radio research on dynamic spectrum access.

2.4.1 Software Defined Radio

One of the most important enabling technologies to the application and success of cognitive radios is an adaptive, flexible, and powerful radio platform [56]. Compared to some modern electronics devices that integrate communication components such as Bluetooth, WiFi, and RFIC, software defined radios (SDR) are designed to be capable of integrating those standards in the software domain rather than hardware domain. The structure of an ideal SDR, as shown in Figure 2.11, is simply a wideband radio frontend and two highspeed converters between analog and digital signals beyond the software digital processing units.

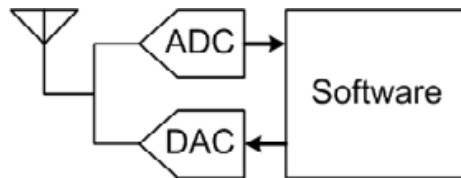

Figure 2.11: Ideal SDR with direct conversion between analog and digital world at the antenna port (from [56]).

The benefits of SDRs include not only the flexibility of creating a variety of waveforms, but also the elimination of all analogue non-idealities that troubled the elderly in wireless communications. Electrical engineers have come a long way fighting with the analog performance of electronics. The concept of SDRs can greatly shorten the design cycle of radios by moving the prototyping and testing to software domain.

2.4. SOFTWARE DEFINED RADIO AND COGNITIVE RADIO

Although bearing grand expectation, the state of the art of SDRs is still at a juvenile stage. Current SDR platforms such as USRP can only satisfy the needs for education and simple prototyping in physical layer and minimal MAC layer. Many challenges remain across a variety of disciplines, such as processor technology, FPGAs, and analog/digital converters.

2.4.2 Cognitive Radio

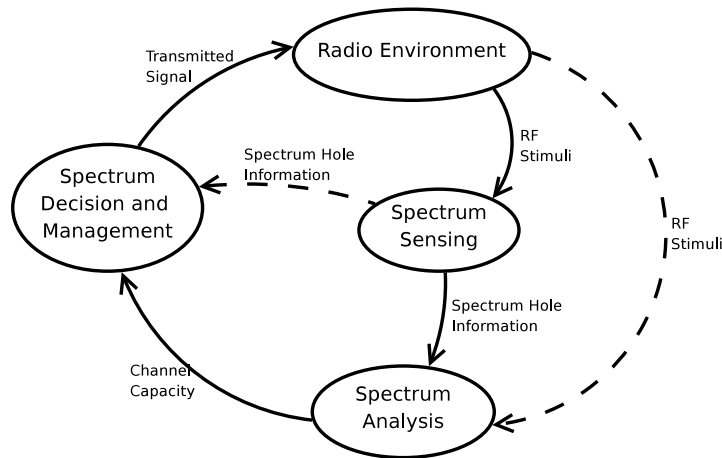

Figure 2.12: A diagram of cognitive radio cycle.

Depending on the applications and the focus of researchers, the definition of cognitive radios can vary. Some may stress on the radio flexibility, while some put importance on the capability of learning. Early visionary works [57] borrowed the concept of cognitive cycle from cognitive science and presented a cognitive radio cycle as shown in Figure 2.12. With respect to definitions, the following can be found:

“Radio etiquette is the set of RF bands, air interfaces, protocols, and spatial and temporal patterns that moderate the use of the radio spectrum. Cognitive radio extends the software radio with radio-domain model-based reasoning about such etiquettes.” [58]

“A ‘Cognitive Radio’ is a radio that can change its transmitter parameters based on interaction with the environment in which it operates.” [10, 57]

“Cognitive radio technologies can enable a radio device and its antenna to adapt its spectrum use in response to its operating environment.” [59]

2.4. SOFTWARE DEFINED RADIO AND COGNITIVE RADIO

“Cognitive radio is a paradigm for wireless communication in which either a network or a wireless node changes its transmission or reception parameters to communicate efficiently avoiding interference with licensed or unlicensed users.” [60]

“A cognitive radio is a transceiver that automatically changes its transmission or reception parameters, in a way where the wireless communications can have spectrum agility in terms of selecting available wireless channels opportunistically.” [61]

“Cognitive radio is an intelligent wireless communication system that is aware of its surrounding environment (i.e., outside world), and uses the methodology of understanding-by-building to learn from the environment and adapt its internal states to statistical variations in the incoming RF stimuli by making corresponding changes in certain operating parameters (e.g., transmit-power, carrier-frequency, and modulation strategy) in real-time, with two primary objectives in mind [62]:

- highly reliable communications whenever and wherever needed;
- efficient utilization of the radio spectrum.”

“A radio aware of its environment, internal state, and location, which autonomously adjusts its operations to achieve desired objectives in response to unexpected changes in these characteristics. Such a radio will also often incorporate software defined radio functionality.” [63]

“Cognitive radio system (CRS): A radio system employing technology that allows the system to obtain knowledge of its operational and geographical environment, established policies and its internal state; to dynamically and autonomously adjust its operational parameters and protocols according to its obtained knowledge in order to achieve predefined objectives; and to learn from the results obtained.” [64]

Cognitive radio has been closely related to the secondary access to licensed spectrum in an hope to mitigate the uneven distribution of communication load in different frequency bands. It is true that secondary users have to be equipped with cognitive radio so as to identify primary users and avoid interference, but the applications of cognitive radios do not have to be limited in secondary access. When equipped with cognitive radio, devices working in unlicensed bands can also benefit via achieving better coexistence with other wireless networks or even aggressively jamming competing users. For example, some commercially available WiFi access points are already equipped with smart channel selection function that automatically sense available channels and choose a best one, although the implemented

algorithms can vary significantly for different manufacturers. Primary users equipped with cognitive radios can for instance achieve a paradigm of dynamic spectrum leasing [65] with other users, which would lower the cost of the primary users for buying spectrum from government, and even enjoy the space diversity via using secondary users as relay nodes.

In a more general sense, the cognitive capability does not have to be provided by a single stand-alone radio device. Some steps in the cognitive cycle, such as spectrum sensing and spectrum negotiation, can be accomplished by other units. For example, infrastructure can be built to provide spectrum sensing capability that overcome the limit of local sensing on a single radio. In fact, such system-level cognitive radios are more readily accepted by the society. After years of research, the first practical cognitive radio standard and real networks implementations that come into reality is IEEE 802.22 networks in TV whitespace, of which a large part of spectrum sensing capability is provided by spectrum server providers independent of secondary access users. Secondary users only need to access such spectrum servers for a binary decision on the availability of spectrum bands at desired location.

2.5 Machine Learning and Artificial Intelligence in Cognitive Radio Systems

Many regard machine learning as one branch of artificial intelligence (AI). AI is usually defined as “the science and engineering of making intelligent machines” [66] or agents, while machine learning has been a central part of AI since the beginning. While creating an agent involves every aspect from interface to understanding a problem and self-evolution, machine learning is about designing algorithms to solve the core problems and if possible to evolve to get better at it.

Ever since the concept of cognitive radio was coined [11], machine learning techniques have been applied across various aspects of cognitive radio design, such as signal classification [67] and transceiver optimization [68]. A conceptual architecture was proposed in [69], and an implementation framework with case-based reasoning was proposed in [70, 56]. Some problems related to cognitive radios can be formulated or transformed into classic machine learning problems, and they can be solved using a rich set of tools developed by machine learning community. Table 2.1 provides some examples of successful applications.

Table 2.1: Some problems in cognitive radio that are solved by classic machine learning approaches.

Problem description	Machine learning tools
Capacity maximization in an AWGN channel. Adjusting datarate based on SNR reading.	Simple reasoning and knowledge base [69]
Signal classification. Finding the best match between observed signal and reference signals.	Artificial neural networks [71]
Multi-objective multi-parameter optimization. Adjusting radio parameters to optimize performance via maximizing/minimizing objective functions.	Genetic algorithms [68, 26]

2.5.1 Reinforcement Learning

Reinforcement learning [72] is concerned with how an agent ought to take actions in an usually dynamic environment based on one or more sources of feedback. The agent implementing reinforcement learning will assess the success of each action at each state. Some problems require agents to maximize long-term reward such that the selection of action at each state is influenced by both the immediate reward and the cumulative reward in subsequent states [73]. In most diagrams of reinforcement learning, such as Figure 2.13, there are an agent, an environment, and three directional information flow, namely action, observation, and reward.

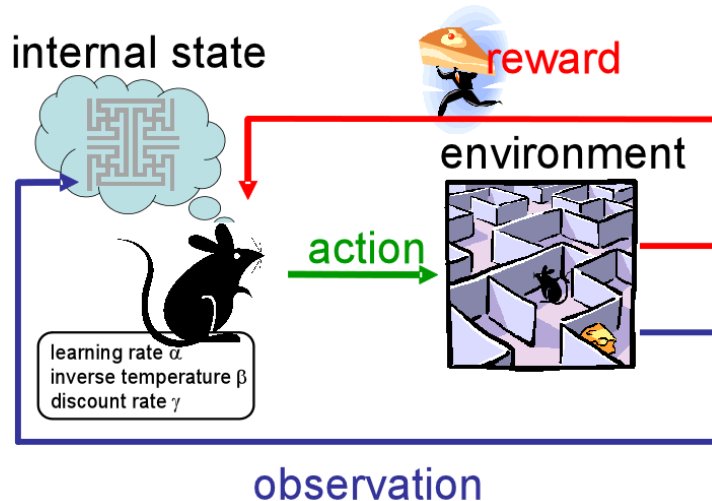

Figure 2.13: A diagram of reinforcement learning (from [74]).

If the environment can be modeled using finite states and actions, exact solutions can be found using classical machine learning techniques. However, in most practical cognitive

radio problems, the environment cannot be completely modeled using finite states and actions, or the state of the environment is not completely observable.

A simple method of reinforcement learning is learning automata [75]. There has been successful application of learning automata in cognitive radio area. In [76], the authors proposed to use learning automata to learn primary user channel occupancy and avoid interference. In [77], the authors used a learning automata to decide whether to transmit a packet or not depending on channel sensing. A multi-armed restless bandit was used to model the channel selection process of a secondary user in slotted networks, where primary user traffic was modeled as discrete-time random process [78].

2.5.2 Metaheuristic Search

Metaheuristic designates a computational method that optimizes a problem by iteratively trying to improve a candidate solution with regard to a given measure of quality. Since metaheuristics make few or no assumptions about the problem being optimized and can search very large spaces of candidate solutions, they have been applied to optimizing wireless communication systems with very large solution spaces. Example algorithms include genetic algorithms [79] and simulated annealing [80].

Genetic Algorithms Genetic algorithms are searching techniques that utilize a series of evolutionary techniques, such as *inheritance*, *mutation*, *selection*, and *crossover*, to find exact or approximate solutions to optimization or search problems. A genetic algorithm maintains multiple solutions. Each solution is represented by a sequence of variables. Each variable is then encoded as a part of the *chromosomes* as shown in Figure 2.14, either as several bits or as a floating number.

parameter A (frequency)	parameter B (power)	parameter C (modulation)	parameter D (bandwidth)	...
----------------------------	------------------------	-----------------------------	----------------------------	-----

Figure 2.14: An example of encoded parameters used in Genetic Algorithms.

The computation usually starts with randomly generating a group of parameter tuples as the first generation. Then, in each generation, the fitness of every individual (solution) in the population is evaluated, multiple individuals are selected from the current population based on their fitness, and recombined (crossover) and possibly randomly mutated to form a new population of solutions. The new population is then used in the next iteration of

the algorithm. Commonly, the algorithm terminates when either a maximum number of generations has been passed, or a satisfactory fitness level has been reached. If the algorithm has terminated due to a maximum number of generations, a satisfactory solution may or may not have been reached.

Genetic algorithms are a generic candidate for solving most multi-dimensional single-objective or multi-objective optimization or search problems, especially for complicated non-linear problems. It has been employed to conduct optimization in communication problems in many occasions [68, 56, 26, 79].

2.5.3 Case-Based Reasoning

Like reinforcement learning, case-based reasoning (CBR) also comes from behaviourist psychology. It mimics the process how people look for prior experience that is similar to current situation. The prerequisite of CBR is the similarity between current situation and prior experience in memory. A typical case-based reasoning process includes retrieval, reuse, revision, and retention [6] is shown in Figure 2.15. The case-based reasoning approach can avoid repeated searching of the best solution in similar environment states, thus possessing the potential of reducing the convergence time of the cognitive engine employed in vehicle communications when traveling in the same area during the during the same time of a day or a week.

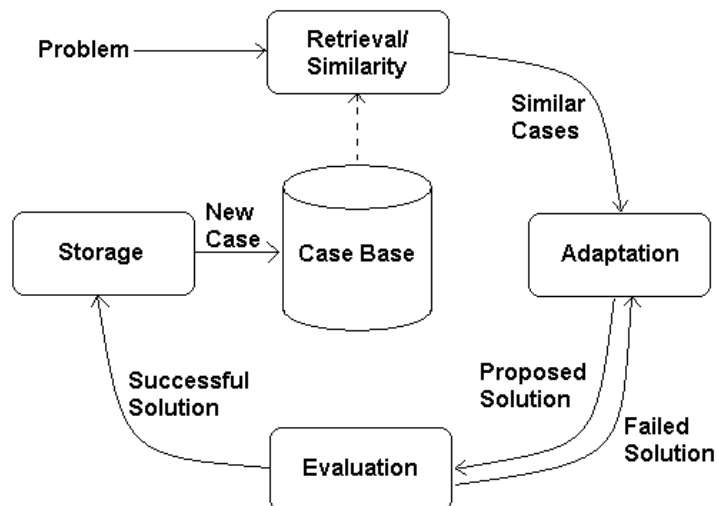

Figure 2.15: A full cycle of case-based reasoning (from [6]).

The implementation of CBR highly depends on the systems to which they are applied. In [81], the case base was implemented as radio environment map, which is an integrated database consisting of information such as channel occupancy and registered protected users. Particularly, they tried to solve the hidden node problem in order to reduce harmful interference from secondary users to primary users. In [82], the authors applied a “knowledge-based reasoning” to improve spectrum sensing efficiency. Another approach is the use of spectrum server to find unutilized channels as defined in IEEE 802.22 [83], although the case base only contains location and channel usage of registered primary users and the unutilized channels are calculated by the spectrum server in real time.

Since CBR requires large memory and processing power, it is more suitable for larger systems with adequate resources, such as base stations, vehicles, larger aircraft, and ships.

2.5.4 The Learning Paradigm of Cognitive Radio Networks

The previous topics of this section can be applied to both standalone agent solving an isolated problem and multiple independent agents working interactively in a shared environment. When not specified, however, the techniques above usually refer to standalone problems.

When studying a network of cognitive radios, for instance a highway with vehicles equipped with cognitive radios for multi-purpose communications, the behaviours of individual agents when interacting with other agents and the outcome of such interaction are crucial for the robust operation of the network. The problem has been approached from multiple disciplines, most notable ones being artificial intelligence and game theory [84, 85]. Related topics include multi-agent reinforcement learning, game theory equilibrium, and Markov Decision Process. While game-theory-based analysis focuses on the learning dynamics, the AI approach focuses on designing individual agents and protocols that ensure the stability of learning.

The common ingredient is the other response of other users to an agent’s own actions. Depending on the level of mutual interference among users, a large complex research problem, such as the channel sharing among individual vehicles and stationary wireless radios, may be decomposed into small problems with weak mutual interference.

2.6 Cooperative Communications and Game Theory in Cognitive Radio

Wireless communication devices are becoming increasingly flexible in terms of their functionality, which has given rise to the introduction of new transmission paradigms, networking architectures, and wireless applications that were not feasible only several years ago. One paradigm that has been receiving significant attention from the wireless community is *cooperation* among users, where wireless nodes assist in the transmission of information between source and destination nodes belonging to the same network, as shown in Figure 5.1. There are several approaches of implementing intra-group cooperation in a general sense within the context of wireless networks, such as cooperative transmission [86, 87, 88], cooperative relay (CoopMAC [89]), and power control schemes using utility functions priced on transmission power consumption [90]. A list of eight types of cooperation possessing different degrees of cooperation was given in [91]. Besides, there is also cooperation in spectrum sensing employed by secondary cognitive radios to enhance the probability of detecting primary user activity [92]. A cooperative game was applied in [93] to study the incentives and fairness in the scenarios where users can form a group and use cooperative transmission to help users located near the boundary of a wireless network. While cooperation in the form of resource sharing is the primary subject in the area of dynamic spectrum access (DSA), the major stream of research on cooperative communication focuses on sharing antennas to relay signals for others, hence exploiting diversity gain.

The above techniques assume a common scheme implemented on all existing users, so the behaviours of all radios are not only homogeneous but also unselfish. When selfishness is included in modeling the interaction among radios, game theory is used in many cases [62]. Game theory, also known as interactive decision theory, is the study of strategic decision making by studying mathematical models of conflict and cooperation between intelligent rational decision-makers. It was shown in [94] that pure competition among radios is inefficient in spectrum utilization. Therefore, cooperation is employed and shown to improve spectrum efficiency and radio performance. The current trend of research in cognitive radios has shown that cooperative communication theory and game theory are always used together to generate a full picture of multiuser heterogeneous networks.

The case of spectrum sharing between the primary user and more than one groups of secondary users has not been studied previously, regardless of whether or not cooperation within a secondary user group was taken into consideration. A group architecture for

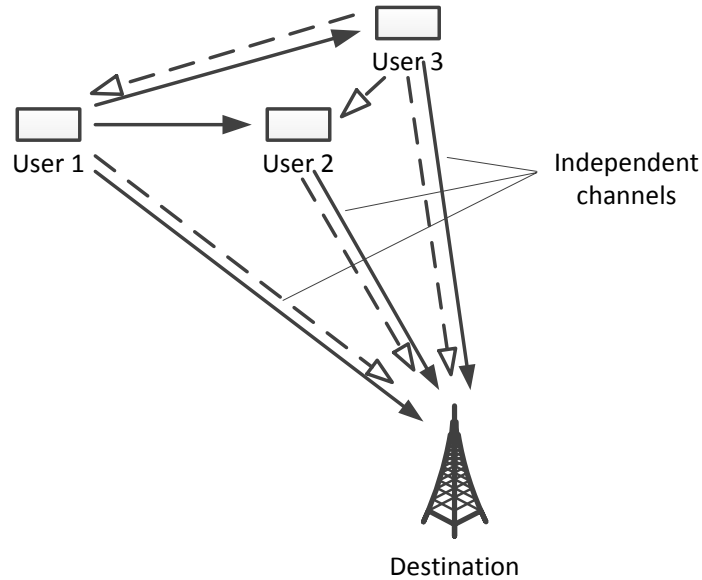

Figure 2.16: A diagram of cooperative communication where radios share antennas to relay signals for others.

secondary users has been proposed before in the CORVUS system [46] where opportunistic spectrum access of secondary user groups is allowed while not conforming to primary user interference constraint. Secondary users are assumed to form groups and a possibility of competition for limited bandwidth among groups is considered but not further studied. Competition among secondary user groups was studied in a spectrum trading paradigm in [95]; however, each secondary user is assumed to make decisions independently and cooperation within a secondary user group is not incorporated to aid winning inter-group competition.

The case of more than one secondary groups of users competing for limited network resource is becoming more important in future networking environments. The process of re-allocate bandwidth to new services using more efficient usage model still falls far behind the demand for higher datarate from customers. Ad hoc network and multi-hop transmission make networks more flexible and self-configurable, hence has a potential to increase efficiency. As such networks as vehicle-to-vehicle mesh networks are not bounded to infrastructure, social activities such as groups are likely to happen, hence competition and cooperation naturally follow.

It was suggested in [96] that cooperative communication can possibly reduce interference

2.6. COOPERATIVE COMMUNICATIONS

to other users since cooperative transmission can achieve the same transmission rate and transmission range with less transmission power. However, this advantage was obtained by trading in possible gain in transmission rate. In other words, such interference mitigation is possible if the user group already possesses a sufficient transmission rate without requiring more. This might not be the case where more than one user group competes for access to a region of wireless spectrum, especially where unlicensed groups compete for access to a limited amount of spectrum while conforming to the primary user interference constraint. From a game theory perspective, when one group chooses the strategy to reduce transmit power to lower interference, the other groups will be tempted to increase their transmission power, filling the primary user interference margin, in order to achieve a higher throughput.

Cooperative communication has been shown to be capable of extending transmission range [89] and combating fading [88]. While a user group can benefit directly from employing a cooperative scheme, there is also an impact on the other groups within the vicinity as well. An example is the issue of increased interference due to multiple nodes being involved within a cooperative scheme [97]. For conventional networks composed of only licensed users under fixed spectrum allocation, this may not be a significant issue. However, in a network based on a multiple access scheme consisting of both licensed and unlicensed transmissions operating in a concurrent manner, the impact of inter-group competition among unlicensed users can result in different outcomes when formulated within the context of a medium access game.

In order to better understand the effects of intra-group cooperation on inter-group competition, the existing cooperation schemes for both primary users and secondary users can be classified in to the following two general categories:

Harmony Cooperation A harmony cooperation requires a user to constrain its wireless access defined by an operating parameter the common medium, such as transmission power or bandwidth usage. A typical example users yield transmission resources to each other is the power control game employing a price utility function [90], where everyone in the network reduces its output power such that the signal-to-noise ratio (SNR) for each user remains at the same level and every user benefits from lower power consumption. Such cooperation requires the conformity of every user in the network. A non-conforming user can introduce a significant performance degradation to cooperating users within the network.

In spectrum sharing networks, harmony cooperation is well-suited for primary users who possess a guaranteed quality of service but have to conform to a large-scale regulation that

controls a majority of users. Primary users by design tend to be passive with respect to receiving transmissions under the assumption of a fixed spectrum allocation without non-conforming users. However, in a heterogeneous network consisting of coexisting primary user and groups of aggressive secondary users, harmony amongst everyone is not likely to exist over a long period of time since several secondary users may attempt to take over all of the resources left by the primary users thereby breaking the harmony of secondary users mutually yielding to each other.

Synergy Cooperation This is made possible by the collective efforts from each member. A synergy cooperation requires other users to use their own resources to access the common medium. Several examples include all types of cooperative transmissions [88, 98] and virtual MIMO transmissions [99], where users benefit from space or frequency diversity in order to combat multipath fading. Such cooperation is possible both in large scale networks possessing tens of users and in small scale networks with a couple of users. However, coordination becomes difficult when the number of users is large, and most of the practical schemes have only considered links consisting of a small number of cooperating users or relays. Thus the problem of selecting users to cooperate with is crucial. Moreover, since cooperative transmission is initially designed to combat fast multipath fading, a high degree of adaptivity is required compared to harmony cooperation.

Note that a cooperation scheme can be a combination of harmony cooperation and synergy cooperation. Harmony cooperation is more likely to occur among primary users with authorized access of spectrum, while synergy cooperation is more suitable for unlicensed users without spectrum licenses. Having no authority means there is no “membership” and anyone can obtain access to the wireless spectrum, which means if one user does not occupy a portion of spectrum, another user will. Having an authority implies there is a supervisor of all activities, and fair QoS is guaranteed in exchange for conformity from every member.

2.7 Chapter Summary

This chapter summarizes the background knowledge related this dissertation. The topics covered are vehicle communications, spectrum scarcity, occupation, and utilization, software defined radios and cognitive radios, artificial intelligence, and cooperative communications. While they are separated topics by themselves, vehicle communications possess the potential to combine them, and it is the cross-discipline efforts that revolutionize vehicle communication.

Chapter 3

Vehicular Dynamic Spectrum Access[†]

In this chapter, we introduce the concept of vehicular dynamic spectrum access (VDSA). We first take a system level approach to lay out the ecosystem of vehicle communication and the role of VDSA. Then a queueing theory based feasibility study of VDSA using TV whitespace is presented.

3.1 The Ecosystem of Vehicular Communications

An application ecosystem is the combination of services available for the customers. The deployment of vehicle communications is not to simply combine a radio to a car. While Google can test their individual self-driving vehicles by mounting an expensive radar on the car and let it drive on the road system, it is more difficult to test vehicle communication since it involves either the road-side infrastructure in the V2I case or the interaction of several dozens of vehicles in the V2V case. Similar to the case of cognitive radio, a global system enabling vehicle communications may come into our daily lives earlier than stand-alone vehicles with full-blown communication functionalities. The ecosystem of vehicle communication can be divided between V2I and V2V at the beginning, and integration of the two parts may be possible in the future. A conceptual view of a variety of vehicle communications is depicted in Figure 6.1.

For all types of V2I communications, such as toll collection and fleet management systems, communications are limited to the coverage area of infrastructure. In the case of

[†]This work has been published in parts in IEEE Vehicular Networking Conference [19].

3.2. QUEUEING MODEL FOR VDSA CAPACITY

toll collection, the infrastructure are the tag sensor with connected to a database; while in the case of fleet management system, infrastructure contain cellular backbone and maybe satellite relays.

While V2I communication requires significant investment in infrastructure, V2V communications can be realized more readily from the manufacturers' side. Imagine a three-dimension space of two-dimension geolocation and one-dimension frequency spectrum, the infrastructure-based networks only occupy those area around base stations, leaving the rest for ad hoc vehicular wireless communications.

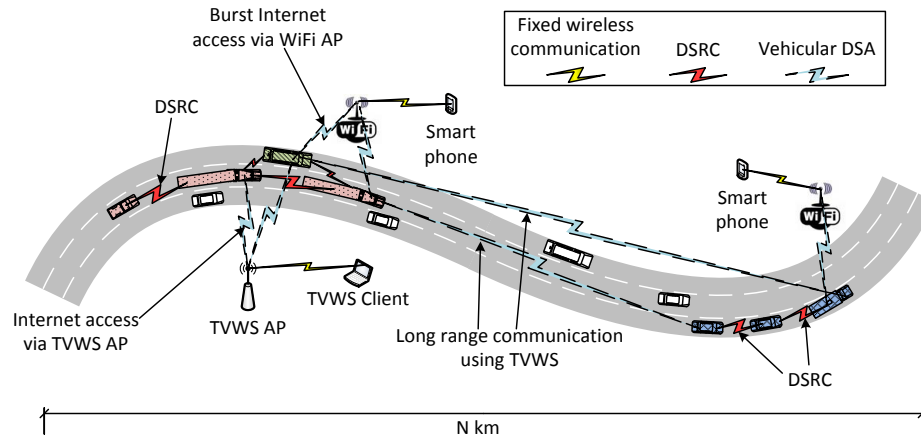

Figure 3.1: A conceptual view of a variety of vehicle communications.

3.2 Queueing Model for VDSA Capacity

In this section, we focused on the capacity of V2V communication in a VDSA scenario. Specially, we consider the TVWS as the candidate band for implementing VDSA. The TVWS availability is dependent on location, as shown in Section 2.3.1. When this variation of channels is coupled with number of vehicles trying to access the channel, which is also depending on location and time, the capacity of single vehicle transmission pairs becomes more difficult to predict. In other words, it was not clear how these vacant TV channels translate into an amount of available resources that can be assessed using some quantitative performance measures. One way to perform this analysis is via queueing theory, which has been known to permit the derivation of several performance measures including the average waiting time and the probability of encountering the system in certain states, such as empty

and full [100].

3.2.1 Queueing Theory

Queueing theory has been used a lot in modeling multiple access or transmission delay in communication systems [101, 102, 103]. An example of queueing model is shown in Figure 3.2. Some work has been done for queueing analysis in cognitive radio systems [104, 105, 106, 107, 108, 109]. Usually, these studies apply the queueing theory with interruptions [110] or vacation models of queueing [111]. The vacation model of a queueing system studies the case where the servers will choose to shut down when there are no users coming in a given time duration [112, 113, 114].

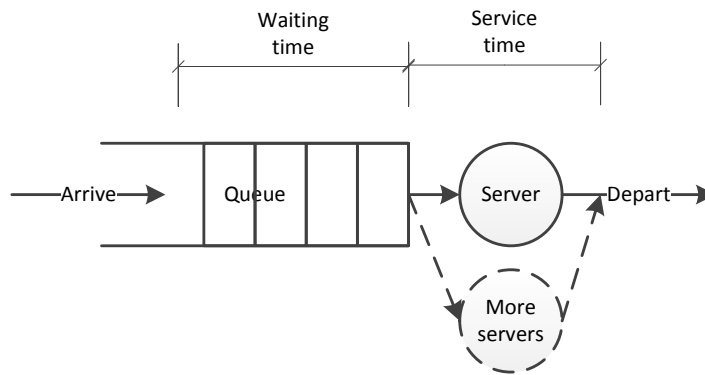

Figure 3.2: An example of queueing model.

The study of queueing models with service interruptions dates back to the 1950s. One of the earliest papers in the area that studied multi-server queueing system with random breakdown is [115]. Queueing system with both breakdowns and server vacations has also been studied [111].

In the recent a couple of years, different traffic models have been used to in queueing systems to model the arrival of primary users and secondary users. In [116], a $G/M/K/0$ is considered to model the queueing system that represents a group of channels and a multiplexed arrival process formed by primary and secondary users. In [117], a $M/G/1$ queue is used to model a system containing one primary user and multiple secondary users, where secondary users function as cooperative forwarder for primary users. $M/G/1$ queue is also chosen to model the system in [118]. In [104], a $M/M/1$ queue with service interruption caused by primary users is considered to model the situation faced by secondary users. A

3.2. QUEUEING MODEL FOR VDSA CAPACITY

pricing policy is used to charge each secondary user that enters a queue, such that a social optimal for all secondary users can be reached.

Priority queue is commonly considered in modeling a system consisting of primary users and secondary users. Some use the assumption of preemption-resume. Preemption-resume is the simplifying assumption that the secondary users packets preempted by primary users halt the service until channel is free, at which time the secondary transmission is continued from the time at which it was interrupted. In real wireless communication systems, the work conserving (preemption-resume) strategy is not feasible since each transmitted packet must carry signalling information (e.g. bits for the Cyclic Redundancy Check, physical layer preambles, MAC addresses etc.). Consequently, whenever a transmission is aborted, the corresponding packet must be entirely retransmitted, eventually repeating in the retransmission the very same signalling information carried by the original transmission [105].

3.2.2 System Modeling using Queueing Theory

The problem of traveling vehicles performing dynamic spectrum access across location-varying vacant TV channels is an opportunistic multiple access problem as shown in Figure 3.3(a). We assume a transmission range of 300 meters for each consumer vehicle, the same as the transmission range defined in DSRC. The numbers of cars per kilometer in each direction of a highway vary depending on location as well as time. Given the spatial-temporal database of available channels as illustrated in Figure 3.3(b) from [5], which is also described in the FCC rules [51], we estimate the number of cars in the proximity and aim to estimate the performance measures including the probability of access blockage and the expected service response time. This dynamic spectrum access system, although seemingly distinct from a queueing system, can be transformed into a virtual queueing system as shown in Figure 3.4 after making several assumptions and abstractions as follows. Although there is no physical existence of a queue, we used a virtual queue to approximate the process [19].

First, it is important to note that we are now trying to predict the performance measure at a time-location snapshot when the vehicles are traveling along highway instead of the overall performance during hours of driving. We consider each time-location snapshot to be about one minute wide in time and one kilometer wide in location and aim to obtain the performance measures corresponding to the transmission of a single packet. Once we have the performance measures of each snapshot, the overall performance measures can be easily obtained.

3.2. QUEUEING MODEL FOR VDSA CAPACITY

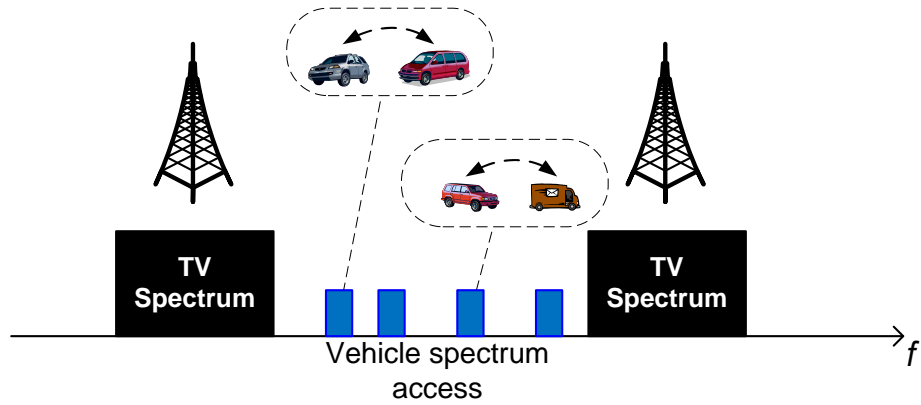

(a) Opportunistic vehicular spectrum access in vacant TV channels

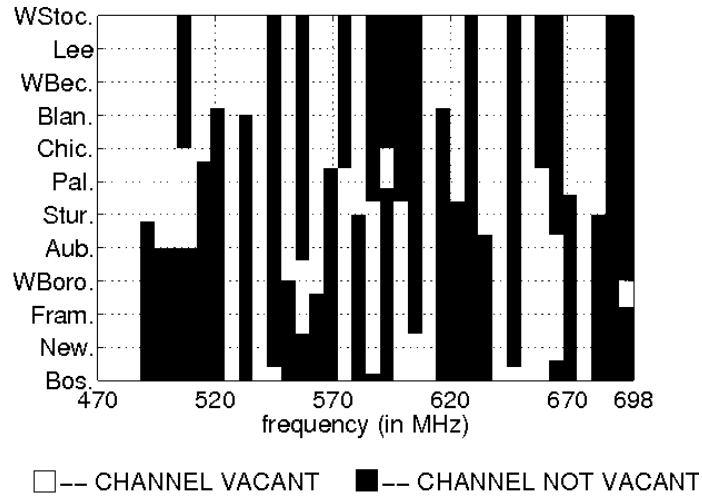

(b) TV channel occupancy along highway I-90 in Massachusetts, USA

Figure 3.3: Vehicular dynamic spectrum access in TV bands lets vehicles access vacant TV channels.

3.2. QUEUEING MODEL FOR VDSA CAPACITY

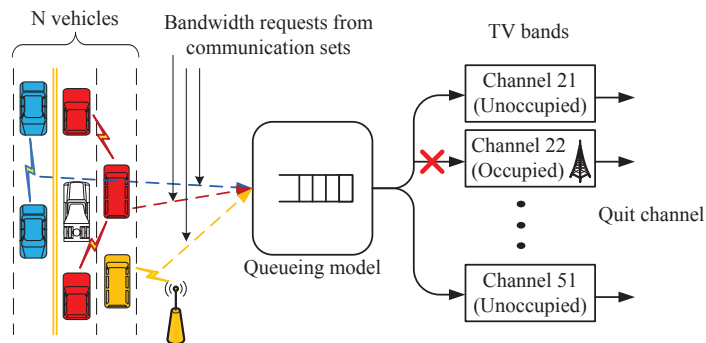

Figure 3.4: Packet-based queueing model for VDSA in vacant UHF TV bands in the case where all vehicles have the same priority [19]. Channel 22 is temporarily occupied by TV broadcast signals and is thus not available for VDSA.

We are not considering each vehicle as a single customer entity in the queueing system. Instead, we consider the bandwidth request from each communication instance as an entity that requesting service. The communication instance is defined as the set of transmitters and receivers performing wireless transmission, regardless of whether the communication is one-to-one, one-to-many, or possibly multiple-to-multiple if cooperative transmission is employed. Transmission can take the form of either vehicle-to-vehicle or vehicle-to-infrastructure. The handshaking between the transmitter and the receiver is assumed to be handled before they start looking for available bandwidth for transmission.

We then model the available bandwidth resource within the transmission range of the vehicles involved in a communication instance as servers. Since the transmission time of a packet is very short compared to the duration of the time-location snapshot we are considering, we assume a static channel status during the transmission of a packet. Consequently, we assume there is no service interruption within a single snapshot caused by channel changes when vehicles travel to an area with different TV channel availability or the channels of different vehicular communication instances collide with each other. The bandwidth requirements for vehicular communication instances are assumed to be the same, and each server is assumed to handle one communication link at a time. There are totally 30 TV channels available for access of portable TVBD, which means there are maximally 30 servers if we consider each TV channel as a server and 180 servers if we consider a sub-channel of 1 MHz as a server.

The transmission time of each communication instance is modeled as the service time of each customer. In the case of multiple priority classes, the transmission time will include the

3.2. QUEUEING MODEL FOR VDSA CAPACITY

retransmission time if interrupted by users of higher priority. In addition to the transmission time, the response time of delivering each packet also includes the waiting time if all channels are busy. The total time cost of each packet also includes the inquiry time to check channel availability database and channel sensing time, which are usually constant.

We assume that CSMA/CA is employed by the transceiver on each vehicle to prevent collisions of data packets. If the communication instance senses a vacant sub-channel, it will claim the sub-channel and start transmitting in that sub-channel. If all sub-channels are sensed busy, it will start a back-off process similar to that in 802.11 CSMA/CA. In the case of a light traffic load of data packets, the packet collision can be almost perfectly avoided using CSMA/CA, thus the VDSA multiple access system can be readily thought of as a virtual queue following a first-come-first-server scheme in each priority class. In the case of a heavy load where CSMA/CA cannot perfectly prevent packet collision, a queueing model will not be able to accurately capture the behaviour of the VDSA multiple access system and will give an overly optimistic prediction of performance measures. On the other hand, a high job intensity in queueing theory means high server utilization for the same service rate and number of servers. When server utilization is close to unity, the response time of each customer will increase tremendously and become unacceptable to users, in which case an accurate performance prediction become less meaningful. Therefore, we will only use this queueing model to predict the performance of a VDSA system under low and medium traffic load that will not saturate the wireless medium.

We also include priorities in the queueing model to address different priority classes of users using the vacant TV bands. Users of higher priorities are assumed to be able to preempt users of lower priorities. Users of same priority enter the same virtual queue as described above. In practice, preemption of lower class users can be achieved by letting each user of lower priorities listen to a separate channel where users of higher priority use to transmit bandwidth request signals. If a bandwidth request signal from users of higher priorities is received, users of lower priorities must quit the channel. Users of lower priorities will regard users of higher priorities as primary users with the same priority as TV broadcast signals.

Consequently, we end up with a multi-server multi-priority queueing model to predict the performance measure of transmitting a packet via vacant UHF TV channels. The predicted results are dependent on the estimated number of cars as well as the available vacant TV channels within the transmission range.

3.2.3 Solutions for the Queueing Model

First, we start with a brief note on the notations and some preliminary results as follows. Poisson arrival rate is assumed for all types of services considered. The probability of seeing no jobs on arrival and the probability of blockage (seeing m jobs on arrival, where m is the number of servers), are only dependent on the number of servers m and the traffic intensity ρ . They are independent of service time distribution and customer arrival distribution. The probability that there is no jobs in service, P_0 , and the probability of all servers being busy, P_m , were given in [100]. The probability of not all servers being busy, also the probability of having at least one vacant sub-channel available, is thus given by $1 - P_m$.

Not all kinds of queueing models have exact solutions for the mean response time. In the case of a simple first-in-first-out queue with no priorities, there are exact solutions if the service time has an exponential distribution. In the case of priority queue, there is only exact solutions if all priority classes have exponential service time with equal mean.

FIFO Queue In the case with no priority, the traffic intensity ρ is defined as: $\rho = \frac{N\lambda}{m\mu}$, where N is the estimated number of cars within the transmission range, λ is the packet rate from each car, m is number of available sub-channels (servers), and μ is the service rate of each server.

An exact solution exists for models assuming Poisson arrival rate and exponential service time, namely M/M/m. The response time R for jobs that do not see available servers on arrival is also an exponential random variable. If we assume Poisson arrival rate and general service time, namely M/G/m, there is not an exact solution for the expected response time, and one approximate solution is given by [119]:

$$E[R] \approx E[S] + \frac{\lambda^m E[S^2](E[S])^{m-1} P_0}{2(m-1)!(m - \lambda E[S])^2}, \quad (3.1)$$

where S is the random variable denoting service time. When the service time S is exponentially distributed with $E[S] = 1/\mu$ and $E[S^2] = 2/\mu^2$, Eq. (3.1) reduces to the exact solution for expected response time in M/M/m queueing model.

Priority Queue In the case with multiple priorities, we assume the class i customers have higher priority over class j customers if $1 \leq i < j$. The total traffic intensity for users of priority classes higher than j is

$$\rho^{(j)} = \sum_{p=1}^j \frac{N_p \lambda_p}{m \mu_p}, \quad (3.2)$$

3.2. QUEUEING MODEL FOR VDSA CAPACITY

where N_p is the number of class p customers, λ_p is the arrival rate of each customer of class p , μ_p is the service rate for each class p customer on a single server, and m is the number of servers. Since users of higher priority can preempt users of lower priority, the existence of users of lower priorities will not affect the performance of high priority users. The probability of having zero jobs in the queue P_0 and the probability of having all servers busy P_m are now functions of $\rho_{(j)}$ for users of priority j .

The solution for the mean service time to a priority queueing model gets exponentially complex as the number of servers and the number of priorities increase. For most papers that analyze multi-server priority queues, the computational complexity is prohibitively high, especially in the case of more than two priority classes. The only fast and usable approximation for multiple priorities is provided by Bondi and Buzen [120] which is based on relating multi-server performance with multiple priorities to single-server performance. This approximation works for all types of service time distribution, but the error increases for high coefficient of variation of the service time distribution.

In this dissertation, we denote the mean response time of class i customers as R_i , denote the arrival rate of class i customers as λ_i , and use $\bar{R}_{(j)}$ to denote the overall average of the mean response times of the j highest priorities. According to Little's law, the total amount of service time for all priority classes can be expressed in two forms,

$$\sum_{i=1}^j \lambda_i \bar{R}_{(j)} = \sum_{i=1}^j \lambda_i R_i, \quad (3.3)$$

which gives us the mean response time of class j customer as

$$R_j = (\bar{R}_{(j)} \sum_{i=0}^j \lambda_i - \bar{R}_{(j-1)} \sum_{i=0}^{j-1} \lambda_i) / \lambda_j. \quad (3.4)$$

The overall average of the mean response times of j highest priority classes can be approximated using a similarity between priority queue and non-priority queue in the ratios of mean waiting time when transforming a multi-server queue to a single server queue with same capacity. The ratio of mean waiting time for a non-priority queue can be approximated by

$$\gamma \approx \frac{P_m}{\sum_{i=1}^j \frac{\lambda_i}{m\mu_i}}, \quad (3.5)$$

and the overall average of the mean response times of j highest priority classes in a priority queue can be approximated by [120]:

$$\bar{R}_{(j)} \approx \frac{1}{\bar{\mu}_{(j)}} + \left(\frac{1}{\sum_{i=0}^j \lambda_i} \sum_{i=0}^j \lambda_i r_i - \frac{1}{m\bar{\mu}_{(j)}} \right) \gamma, \quad (3.6)$$

3.2. QUEUEING MODEL FOR VDSA CAPACITY

where

$$\bar{\mu}_{(j)} = \frac{\sum_{i=1}^j \lambda_i}{\sum_{i=1}^j \frac{\lambda_i}{\mu_i}}. \quad (3.7)$$

$\bar{\mu}_{(j)}$ is the overall service rate for all j highest priority classes defined as a weighted average of the service rates of all j highest priority classes, and r_i 's are the response times of the individual classes in an M/M/1 or M/G/1 preemptive-resume priority system with service rate being $m\mu_i$ given in [100].

3.2.4 Analysis of VDSA in Vacant UHF TV channels

In this work, we employ the data collected from I-90 in the Commonwealth of Massachusetts shown in Figure 3.5(a) in order to analyze the performance of VDSA in vacant UHF TV channels. We took 12 samples along I-90 of the total number of cars in all lanes within a kilometer and interpolate the samples to obtain an estimate of average number of cars per kilometer along I-90 shown in Figure 3.5(b). The available bandwidth in vacant UHF TV channels for TVBD, given in Figure 3.5(c), is derived from the results of spectrum measurement campaign in [5].

The distribution of TV white space along I-90 shown in Figure 3.3(a) indicates that the available vacant TV channel blocks are generally non-contiguous, which means most TV white channels are adjacent to busy TV channels for broadcasting. As defined in the FCC rules [51], the output power of portable unlicensed devices in vacant channels adjacent to TV broadcasting channels is restricted under 40 mW. Thus we assume a 40 mW output power limit for all vehicular communications

We then assume that the transmission range of each car is 300 meters, the same as the typical transmission range defined in DSRC, and a 500 meters interference range. The ratio of number of communication instances and number of cars is an unknown variable depending on the penetration percentage of communication-capable vehicles, the types of communication, and the number of radio interfaces equipped on each vehicle. In the following results, we use a ratio of 0.65.

In this case study, we assume a mean packet length of 500 bytes, which is roughly the average packet size for Internet traffic, and 1 MHz sub-channels with data rate of 800 kbps for each customer. This assumption is based on Okumura-Hata path loss model and a noise level of -80 dBm. Thus the transmission time has a mean of 5 ms. The typical messaging interval in safety related applications is 100 ms, corresponding to a message arrival rate

3.2. QUEUEING MODEL FOR VDSA CAPACITY

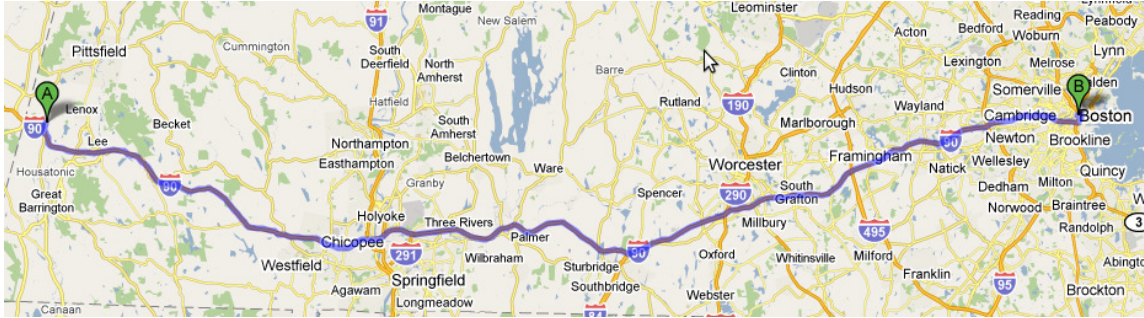

(a) I-90 between Boston, MA and West Stockbridge, MA

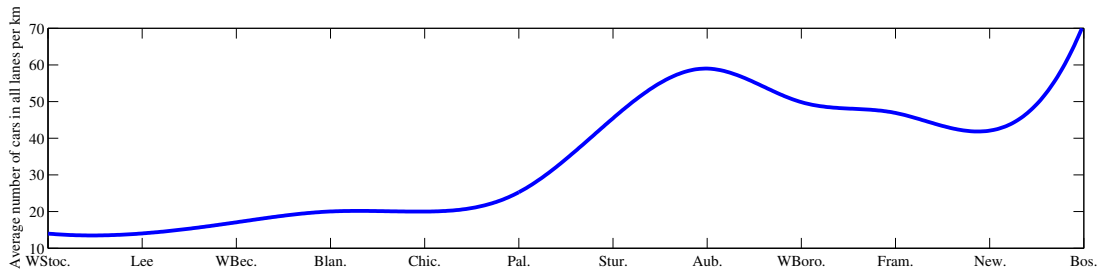

(b) Average number of cars per kilometer along I-90

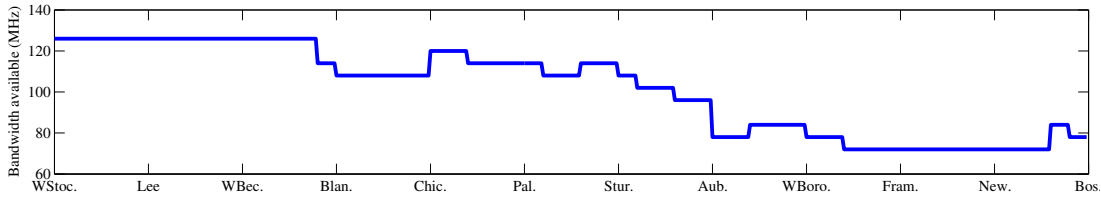

(c) Bandwidth available in UHF TV channels along I-90

Figure 3.5: Map, car density, and available channels along I-90 in the Commonwealth of Massachusetts in USA.

per customer of 10 messages per second for each type of service. We also try higher arrival rates assuming multiple services are being used. Two models are used in this case analysis, which are M/D/m model assuming deterministic service time and M/M/m model assuming exponential service time.

Without Priorities We first look into the case where all vehicles are of the same priority. The probability of seeing all sub-channels be busy and the response time are shown in Figure 3.6(a) and Figure 3.6(b). The probability of all sub-channels being busy is very low in any place except for Boston until the arrival rate goes up to 60 msg/sec. The low

3.2. QUEUEING MODEL FOR VDSA CAPACITY

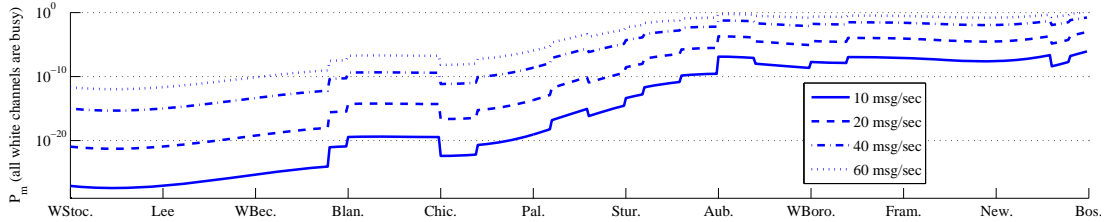

(a) The probability of all channel being busy

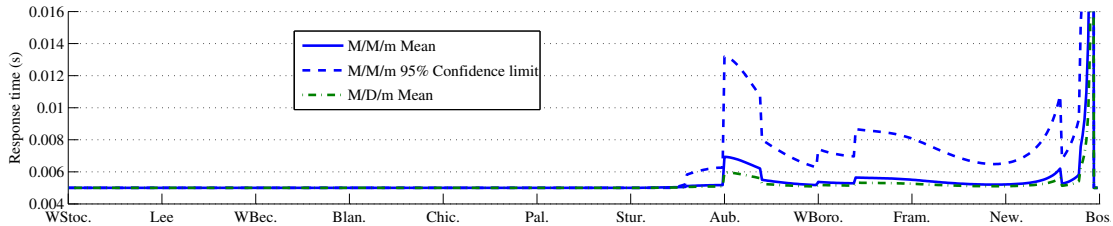

(b) Response time of transmitting packets at an arrival rate of 60 msg/sec and exponential service rate.

Figure 3.6: Predicted performance measures in the case when all cars are of the same priority. M/D/m model assumes deterministic service time, and M/M/m model assumes exponential service time.

probability means that it is very likely that there are sub-channels available for opportunistic unlicensed access. At the arrival rate of 60 msg/sec, Figure 3.6(b) shows that the highest mean response time appears at Auburn along I-90 not including Boston area, which is 7 ms in M/M/m model and 6 ms in M/D/m model, and 95% of customers will observe response times less than 13 ms in M/M/m model. This value is considered acceptable for the purposes of vehicular applications. The mean response time in Boston is at 140 ms, which is above the typical latency limit of 100 ms in safety related applications. However, note that this mean response time is for a message arrival rate of 60 msg/sec which is much higher than the message generation rate of a typical safety application, and hence can be considered as a stress test for this case. The expected response time assuming deterministic service with zero variance in service time is also included in Figure 3.6(b), which is about half the mean response time when we assume exponential service rate.

With Two Priorities In this scenario, we assume that all vehicles in the previous simulation be class 2 customers and add 10% of the number of class 2 customers as class 1 customers that can preempt class 2 customers. The probabilities of observing all channels being busy by different classes are shown in Figure 3.7(a). The probability of having no idle

3.2. QUEUEING MODEL FOR VDSA CAPACITY

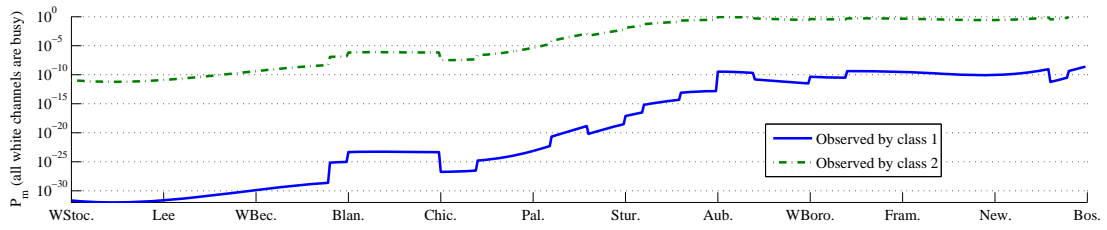

(a) The probability of all channel being busy observed by customers in different classes



(b) Response time of transmitting packets at an arrival rate of 60 msg/sec and exponential service rate.

Figure 3.7: Predicted performance measures in the case where cars have different priorities and same message rate of 60 msg/sec. The number of higher class customers is 10% that of lower class customers. M/D/m model assumes deterministic service time, and M/M/m model assumes exponential service time.

sub-channels is much lower for class 1 customers because the population of class 1 customers is much smaller and class 1 customers can preempt class 2 customers. The corresponding expected response times for both classes are shown in Figure 3.7(b). The mean response times for class 2 customers are still at 5 ms in most places to the west of Auburn. At Auburn, the mean response time of class 2 customers increases to 19 ms in M/M/m model and 12 ms in M/D/m model, and the 95% confidence limit increases to 50 ms, which is still an acceptable number for safety related services with 100 ms maximum transmission limit. Class 1 customers still enjoy expected response time of 5 ms anywhere along I-90 in the Commonwealth of Massachusetts.

3.3 Summary

The results also show that the TV white space is scarce in large cities such as Boston, where the average number of vehicles is also significantly higher than in suburban and rural area. These two factors collectively impair the feasibility of utilizing TV white space as a medium of vehicular communications. However, due to the high concentration of customers in large cities, various means of wireless access such as 3GPP Long Term Evolution (LTE) and a large number of WiFi hotspots can be expected to exist. Hence vehicles will have the option of connecting to backbone infrastructure via existing wireless networks and offloading delay-tolerant applications from vehicle-to-vehicle communication links.

Future vehicles are expected to recognize its wireless environment and decide intelligently how to distribute its communication demands to available wireless access options to enhance traveler experience. However, it is difficult to obtain an accurate estimation of throughput or delay performance of a wireless link in a short time due to the dynamic nature of wireless environment, contributed by high vehicle mobility as well as inconsistent data traffic of other wireless users. Machine learning can be used to predict channel capacity according to both the instant channel sensing feedback and other environment information such as terrain and vehicle density. The problem of dynamic channel accessing in a vehicle communication environment has been neglected in the past because there was not a strong demand of vehicular communications. As wireless communications are being rediscovered as a means of enhancing driving experience, it is necessary to consider beforehand the communication capacity in a vehicle environment as well as the approaches to achieve that capacity.

Chapter 4

Intelligence in Vehicle Communications*

Introducing machine learning techniques into cognitive radios has been widely studied over the past several years. Ever since the concept of cognitive radio was coined [11], machine learning techniques have been applied across various aspects of cognitive radio design, such as signal classification [67] and transceiver optimization [68]. A conceptual architecture was proposed in [69], and an implementation framework with case-based reasoning was proposed in [70]. However, there has been noticeably little research with respect to the design of an architecture specifically targeting vehicle communications, which possesses the potential to become a very large market and may involve the deployment of cognitive radio systems.

4.1 Proposed System Architecture

A vehicle is a sophisticated machine employing a wide range of technologies, such as sensors, batteries, navigation systems, radios, and human-machine interfaces. Our proposed architecture is trying to incorporate all communication-related components and information sources within the context of a vehicle communication network. A diagram of the proposed architecture is shown in Figure 4.1. The source of policies contains information on nationwide and local spectrum regulations that define the spectrum access rules, which are not necessarily the same at every location. The knowledge database of a case-based reasoning engine is responsible for storing all forms of knowledge needed to guide the configuration

*This work has been published in parts in IEEE Vehicular Networking Conference [21] and IEEE Vehicular Technology Conference [23].

4.1. PROPOSED SYSTEM ARCHITECTURE

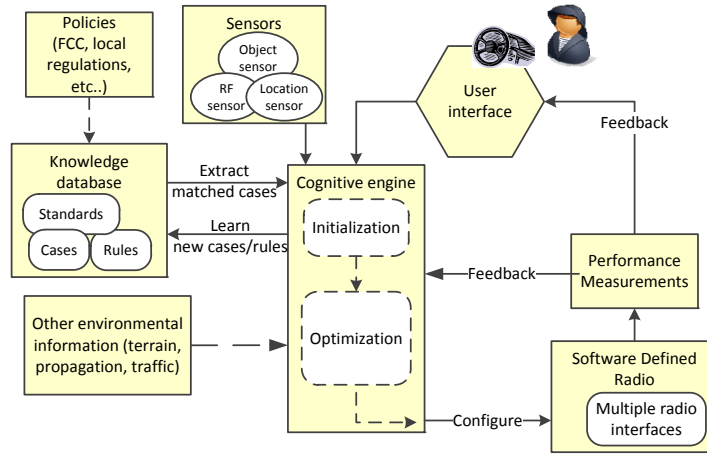

Figure 4.1: The architecture for applying intelligence in vehicular communications. This architecture integrates a reinforcement learning cycle that is capable of environment-awareness, and a case-based reasoning cycle that can learn to improve performance in the long term.

of the vehicle communication devices. Such knowledge can be represented in the form of standards or previous use cases. There are other forms of information, such as vehicle traffic conditions and weather conditions, that will help configure vehicle communications but they are also considered to be dynamic and instantaneous, and thus they will not be kept in the database. These sources of information can be obtained via communications with other vehicles or with roadside units, while the information from various sensors are directly obtained from the vehicle itself.

The cognitive engine is similar to that found in a conventional cognitive radio system, but with more stringent requirements on the convergence speed and quality of service metrics. The implementation of the cognitive engine depends on the application-specific task requirements. For example, support vector machines or artificial neural networks can be used for implementing classifiers [67], genetic algorithms or simulated annealing can be used for performing various types of searches [70], and prediction can be achieved by using hidden Markov chain as well as artificial neural networks.

4.1.1 Case-Based Reasoning Cycle

The cycle of case-based reasoning in Figure 4.1 is composed of a knowledge base, a method of extracting matched knowledge, the cognitive engine, and a method to update the knowledge base. A typical case-based reasoning process includes retrieval, reuse, revision,

and retention [6]. The case-based reasoning approach can avoid repeated searching of the best solution in similar environment states, thus possessing the potential of reducing the convergence time of the cognitive engine employed in vehicle communications when traveling in the same area during the during the same time of a day or a week.

4.1.2 Reinforcement Learning Cycle

The adaptation cycle is composed of the cognitive engine that generates the radio configurations, a software-defined radio with possibly multiple radio interfaces to interact with the wireless environment, and a method of performance measurement that evaluates the performance of radio configurations. This is a typical reinforcement learning problem [72]. The optimal solution for a specific type of vehicle communication application depends on the physical environment, as well as the traffic conditions, both of which are dynamic with a vast state space. In addition, it is impossible to know what configuration is optimal for an environment state beforehand, so any supervised learning techniques are ruled out. Although there is a big loop involving the user interface, the user interaction should be kept to a minimum so as to avoid any unnecessary distractions to the drivers. The role of user in this architecture is mostly offline planning instead of real-time learning, which should be performed automatically by the vehicle. In the rest of this dissertation, we will use a real application of channel selection to demonstrate how the above architecture fits into vehicle communication scenarios.

4.2 Learning-based Adaptive Channel Selection

There is a trend that customer mobile communication devices are integrating multiple means of accessing different frequency bands and multiple wireless services, such as cellular voice services, data services, Internet services, personal area networks, and wireless local area networks. A vehicle has the potential of integrating more means of wireless access than a personal communication device or serve as an omnipotent peripheral device when integrating with personal devices such as cell phones. On the other hand, the high demand of wireless services has caused the change of frequency regulation toward a more open and flexible style. It can be expected that adaptive channel selection will become crucial in future wireless networks. So we will now demonstrate the application of our learning architecture with a channel selection problem in vehicle dynamic spectrum access.

4.2.1 Problem Formulation for Learning Channel Selection in VDSA

We can categorize the possible channel options for vehicle communications into three categories, which are dedicated channels, free access channels, and opportunistic access channels. The opportunistic access channels can be further divided according to their temporal and spatial accessibility.

1. Dedicated channels (e.g., DSRC)
2. Free access channels. Always free in all locations at all time (e.g., ISM)
3. Opportunistic access channels
 - (a) Primary user locations are known
 - i. Deterministic primary user traffic (e.g., TV signals)
 - ii. Random primary user traffic (e.g., Paging bands)
 - (b) Primary user locations are unknown (e.g., Cellular networks)

Examples of dedicated channels include the frequency band for DSRC, which is allocated only to vehicle communications. In order to ensure the reliable transmission of safety-related messages, different types of vehicle communications are prioritized according to emergency. Thus private data communications need to yield to public safety-related communications.

Free access channels include the popular ISM bands that enabled the blooming of WiFi and Bluetooth. WiFi hotspots usually have a coverage less than 100 meters, making it not suitable for a wireless service provider to vehicles with moving speed generally higher than 20 m/s. On the other hand, the large population of WiFi hotspots and the high congestion in ISM band make it less favorable a choice for quality service in vehicle communications.

TV whitespace is recently opened to secondary access including mobile-to-mobile communications, followed by the IEEE 802.22 standard published in July 2011 [83]. This could be a viable option for vehicle communication and an example of future flexible spectrum regulation. We have studied the feasibility of using TV whitespace for vehicle communications in [19]. The TV whitespace is not limited to mobile-to-mobile communications but also between mobile and fixed devices and between fixed devices. It can be foreseen that TV whitespace devices will appear on the market providing Internet access for larger coverage than WiFi due to its allowed maximum power level of 4 watts EIRP.

With all the possible channels above for vehicle communications, the problem of channel selection naturally follows. A multichannel CSMA MAC protocol similar to 802.11 is

4.2. LEARNING-BASED ADAPTIVE CHANNEL SELECTION

proposed in [121], where they use a control channel to coordinate the data transmissions on multiple other channels. A simple random sense-and-access scheme was used to achieve opportunistic access in multiple channels in [122]. Opportunistic access in random mobile environment was studied in [123], where an interactive algorithm is designed to update the probabilities to access all channels. However, this algorithm assumed that secondary user population on each channel is known to all secondary users, secondary users only rely on spectrum sensing to detect primary users, and that the vector of channel probabilities is the same for all secondary users. In addition, they only looked into scenarios with an average moving speed less than 5 m/s. Lee defined an optimal sensing framework in [124] and derived the optimal sensing-accessing schedules assuming that primary user usage characteristics were fixed and known to secondary users, which is not necessarily a valid assumption especially in mobile secondary networks. Lee also looked into the channel selection problem and proposed an approach which selected some channels with low primary user usage and tried to access all of them with equal preference, which may result in excessive channel switching times.

4.2.2 Solution Design

We formulate the channel selection problem as a reinforcement learning problem. We will not limit the problem only to TV whitespace or ISM band, but make assumptions based on a general structure of primary users and secondary users, where secondary users can only use the channel when there is not primary user activities.

As an application of the architecture in Figure 4.1, we keep the learned channel profile as cases in the knowledge base, and use the sensed location in order to extract specific cases. The FCC policies provide the information of what channels are available in the region. The reinforcement learning cycle is implemented as an adaptive channel selection here.

In wireless ad hoc networks, it is an expensive action for a transmitter-receiver pair to perform channel switching. It usually includes exchanging channel availabilities between transmitter and receiver and handshaking on the new channel. According to an experiment of V2V communication in TV whitespace using USRP2s [39], the average channel switching time is 2 seconds. On the other hand, it only takes a negligible amount of time for a single device to change frequency and sense a new channel. Taking these facts into consideration, we design our algorithm to minimize the channel switching time of a transmission pair while avoiding staying in a bad channel. The flowchart of our adaptive channel selection process is shown in Figure 4.2.

4.2. LEARNING-BASED ADAPTIVE CHANNEL SELECTION

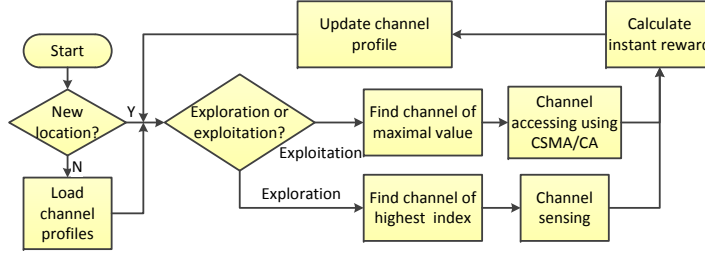

Figure 4.2: The adaptive learning-based channel selection process.

In order to enable learning from past experience, a vehicle needs to keep a set of channel profiles for all possible channels. The profile of a channel s consists of a channel value $V(s)$, an index $I(s)$, and a channel visit times $n(s)$. Given $R(s)$, the instant reward on channel s , the channel value $V(s)$ is updated using a *constant- α Monte Carlo* method [72]:

$$V(s) \leftarrow V(s) + \alpha(R(s) - V(s)), \quad (4.1)$$

where α is the learning rate between 0 and 1.

Any reinforcement learning problem comes with the tradeoff of exploration and exploitation [72]. We use an ϵ -greedy algorithm to determine whether to conduct the process of exploration and exploitation. This algorithm will do exploration if a random number between 0 and 1 is less than ϵ , and do exploitation otherwise. It is well known that an ϵ -greedy algorithm cannot converge with a constant ϵ . Many variants have tried to introduce adaptation of ϵ and gradually decrease the value of ϵ to zero in order to achieve the convergence. At this moment, we use a fixed value of ϵ in our algorithm.

A vehicle will start with trying to identify a set of channel profiles corresponding to the current location and load the stored channel profiles if there is a successful match. Then the decision of exploration or exploitation is made using ϵ -greedy algorithm. The exploitation process consists of a sensing period followed by an accessing period, while the exploration process only does channel sensing. This arrangement is to avoid high time consumption caused by frequency channel switching of an ad hoc communication link.

During the exploitation process, the channel with the maximal value of V is selected as the exploitation channel. During the exploration process, a vehicle will select a channel other than the exploitation channel to perform channel sensing for T_{Sensing} . The objective of the exploration process here is to quickly find the best channel other than the current exploitation channel, such that the transmission can quickly switch to that channel when

4.2. LEARNING-BASED ADAPTIVE CHANNEL SELECTION

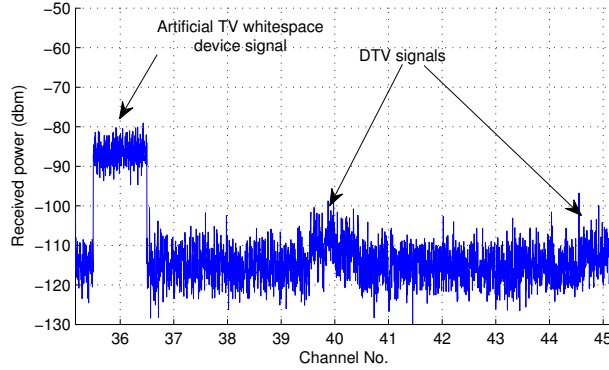

(a) Snapshot of received spectrum

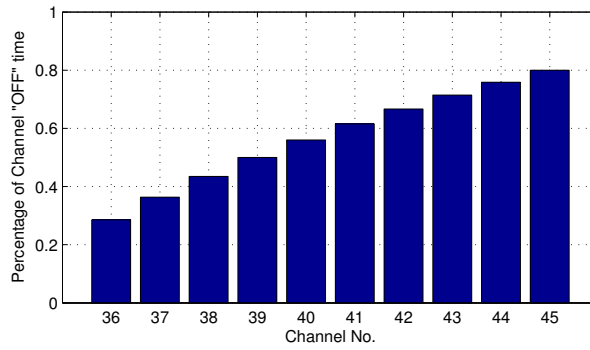

(b) Percentage of "OFF" time on each channel

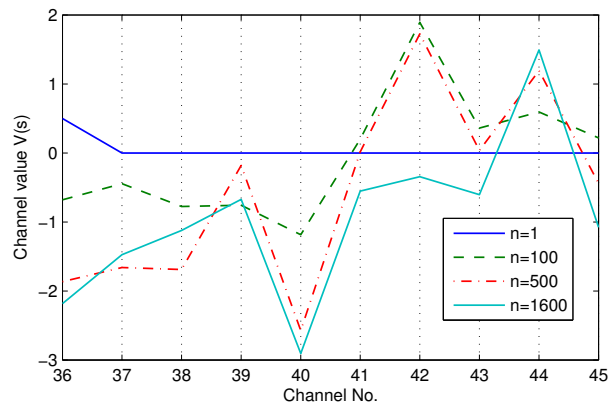

(c) Channel values at different time step n

Figure 4.3: Example of how channel values are learned. (a) Spectrum, (b) Channel "OFF" time percentages, (c) Channel value vectors at different time steps (n).

the current exploitation channel becomes unavailable. Given this objective, we can assign higher reward when a selected channel is sensed free, and lower reward when it is sensed occupied. The goal is to maximize the total reward, which means the confidence that a candidate channel is free in the near past. We use an index-based scheme to choose the exploration channel s that has the highest channel index $I(s)$ defined as:

$$I(s) = V(s) + \sqrt{\frac{2 \ln \left(\sum_{1 < j < K} n(j) \right)}{n(s)}}, \quad (4.2)$$

where K is the total number of available channels. This is similar to the upper confidence bound (UCB) algorithm proposed in [125], where $V(s)$ is replaced by the average of reward received on channel s . This approach will start with sweeping the channel once and bias the channel selection toward those that have been sensed free in the near past. Since a random channel selection used in the conventional ϵ -greedy algorithm assigns equal probabilities to all channels, it will waste limited sensing time on other channels instead of focusing on good channel candidates. The difference will be more significant with larger number of channels.

In Figure 4.3, we show an example of how this algorithm works. We overlap artificial TV whitespace devices traffic on measured digital TV signals, as shown in Figure 4.3(a). The artificial TV whitespace devices are distributed in all available channels with different percentage of channel occupation time, where devices using lower channels have higher duty cycle. Figure 4.3(c) shows an example of how the channel values get updated at different steps as the learning process proceeds. Since channel 40 and channel 45 are occupied by digital TV signals, the values of these two channels are very low as reflected in the learned value vectors. As the learning proceeds, the value vectors can be seen to reflect the true preference of available channels, which are reversely proportional to primary user duty cycle. The peak at channel 44 in Figure 4.3(c) reflects that the transmitter has stayed in this channel for most of the time and has obtained a lot of accessing opportunities.

4.3 Evaluation in Shared TV Whitespace

In this section, we evaluate the learning approach in the scenario of coexistence in shared TV whitespace. It is a widely accepted approach to use a spectrum database to manage secondary access to TV whitespace where UHF channels are unutilized [83, 126]. IEEE 802.22 and IEEE 802.11af are two developing standards to bring WRAN and WLAN respectively to TV whitespace. IEEE 802.22 base station would be armed with a GPS device to report its location and perform channel sharing with other IEEE 802.22 base

4.3. EVALUATION IN SHARED TV WHITESPACE

stations. Given these proposals, an envisioned spectrum occupancy of TV whitespace is illustrated in Figure 4.4. This coexistence scenario is generated by overlapping artificial WRANs and WLANs over measured TV broadcast signals along I-90. Each DTV channel has a bandwidth of 6 MHz, and WLANs are assumed to use channel bounding techniques to bind two adjacent DTV channels to form a 10 MHz-wide channel.

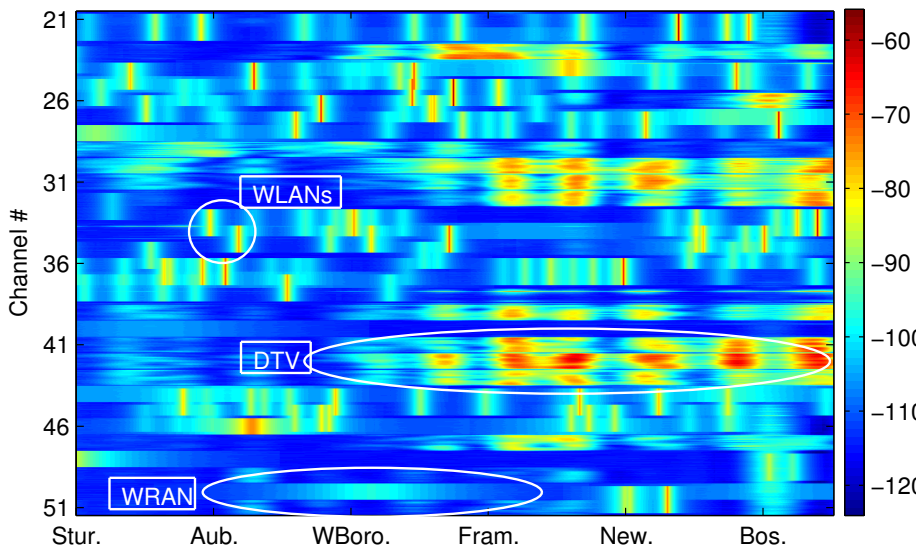

Figure 4.4: A snapshot of simulated scenario where TV broadcaster, IEEE 802.22 WRAN, and WLANs geographically share UHF TV spectrum.

Besides geographical coexistence, spectrum sharing in time and frequency domain is also crucial to achieve coexistence between closely located networks. Figure 4.5 shows an example of frame-based networks and contention-based networks sharing TVWS channels. This coexistence method relies on periodic beacons broadcasted by IEEE 802.22 WRAN basestations, which have larger coverage.

In order to achieve coexistence between vehicle groups and WRANs, V2V communications can benefit from either one-way or two-way coordination with WRAN base stations, such as IEEE 802.22 networks. Vehicle networks and IEEE 802.22 networks already possess the capability of synchronous coexistence. The synchronization required by such coordination can be achieved at vehicles by synchronizing to a global time reference, such as GPS.

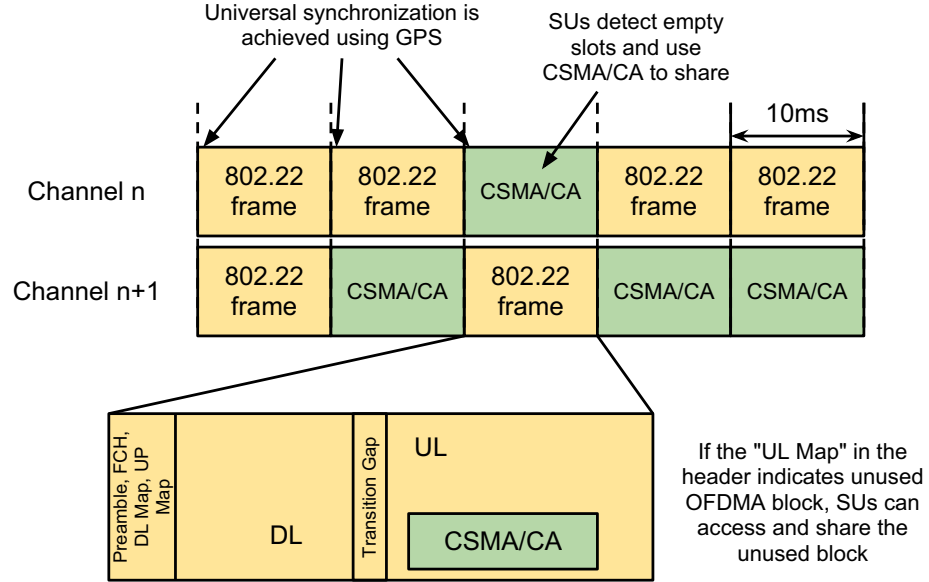

Figure 4.5: An example of coexistence between frame-based PHY and contention-based PHY.

4.3.1 Channel Utilization

Based on the coexistence scheme described above, vehicle networks can measure channel utilization levels in order to both avoid interference with local networks and optimize their own connectivity performance. While the frequency of a channel affects the path loss, hence determines the feasible applications, the utilization of a channel determines the instant availability and possible reward for a vehicular network. The channel utilization depends on the coexistence scheme of all wireless users. Here we assumed a general coexistence scheme illustrated in Figure 4.5.

We can model the possible reward in each channel as a function of its channel properties. Then the reward value can serve as the reinforcement signals for the reinforcement learning algorithm. The properties of a shared channel include the bandwidth, noise level, percentage of 802.22 frames (P_{Frame}), average 802.22 frame utilization (P_{Util}), percentage of channel busy time in a CSMA/CA (ρ), which has an upper bound of ρ_{MAX} , and number of contention users in CSMA/CA duration (N_C).

The total capacity of a channel C can be determined by the bandwidth and noise level.

4.3. EVALUATION IN SHARED TV WHITESPACE

We will focus on the remaining channel capacity C^R , which we model as:

$$C^R = C \cdot (1 - P_{\text{Frame}} \cdot P_{\text{Util}}) \cdot \left(\frac{\rho}{N_C + 1} + (\rho_{\text{MAX}} - \rho) \right) \quad (4.3)$$

The second term represents the temporal space left by the 802.22 WRANs. The third term is an indicator of the reward a new user can obtain via a fair contention scheme.

4.3.2 Channel Sensing

While it is straightforward to select a channel when the exact available channel capacities are known, the temporal variance in channel utilization and channel condition prevent a vehicle network to have perfect measurements of channel properties. Measuring channel utilization is more difficult compared with detecting signal existence, since the channel utilization also depends the accessing protocols used by coexisting users. At this point, we assume that a vehicle is only capable of sensing one channel at a time.

By synchronizing to the 10-ms 802.22 frames, a sensing period start with sensing 802.22 frame preamble and frame header. If no frame during that period, the sniffing mode for 802.11 packets will start, followed by channel idle time calculation. Otherwise, we decode the frame control header for uplink map to find OFDMA holes. If there exist OFDMA holes allowing contention-based secondary access, packet sniffing during OFDMA holes will start.

We found via analyzing the sniffing data of real WLANs that the channel utilization of a pure CSMA/CA channel follows a loglogistic distribution at low contention level and a normal distribution at high contention level. Similar statistics can be expected in future WLANs in TVWS as well.

4.3.3 Adaptation of Learning parameters

In order to better understand and adapt to the environment, key parameters of the learning algorithm are adaptively tuned. The two key parameters are the exploration rate ε and the learning rate α , also known as the step-size. In our channel selection problem, since the learning agent on a vehicle is more interested in whether to switch to a new accessing channel or to remain in the current channel s , the exploration rate ε should represents the confidence level that the there is another channel that has higher remaining capacity than the current channel reward. Hence, ε can be defined as the probability that there exists another channel with greater remaining capacity than the current channel reward

times the maximum possible improvement on channel reward. Assuming the channels are independent of each other, we have:

$$\varepsilon = \left(1 - \prod_{j=1, j \neq s} \Pr [C^R_j < C^R_s] \right) \cdot \left(1 - \frac{C^R}{C} \right). \quad (4.4)$$

When the current channel reward is high, the exploration rate ε is reduced. When exploration rate is reduced, the learning agent becomes insensitive to environment changes. In order to maintain sensitivity to channel variation, we also let the update step size α change inversely proportional to exploration rate ε .

4.3.4 Simulation Setup

In the following simulations, we use the real channel measurements of UHF channel 21 to 51 across I-90 in Massachusetts taken in 2009 [5], and overlap artificial WRANs and WLANs onto the measurements. The following parameters are used for generating WRANs and WLANs:

Table 4.1: Simulation parameters for creating artificial WRANs and WLANs.

	WRANs	WLANs
Density	1/6km	10/6km
Range	25km	2km
Mean of utilization	0.4	0.1 ~ 0.5
Variance of utilization	0.12	0.12

Each vehicle group is assumed to have a moving speed randomly generated between 20 m/s and 40 m/s. We tested a range of vehicle densities with the average number of vehicle groups in each direction per kilometer varying from 1 to 5. 30 scenarios were generated with WRANs and WLANs with random locations and frequency channel. WRANs are assumed to each occupy a DTV channel of 6 MHz, and each WLAN occupies two contiguous DTV channels. Each scenario is tested with vehicle densities from 1 to 5 for 1000 times with random vehicle flows.

4.3.5 Simulation Results

The following three approaches are compared with each other:

- **Random greedy approach:** While continuously accessing the channel, the agent will take a moving average of the channel reward in the past one second, which is

4.3. EVALUATION IN SHARED TV WHITESPACE

composed of ten samples of 100 ms slots, and see if the averaged normalized reward is less than 50% of the channel capacity. When the average is below 50%, the agent will jump to the first channel with less than 50% channel utilization via random sensing over all available channels.

- **Classic value iteration reinforcement learning:** A classic value iteration approach is employed with adaptive exploration rate ε and learning rate α . The exploration channel is chosen randomly among all available channels.
- **Value iteration with UCB controlled exploration:** Instead of a random channel exploration, the agent uses a UCB algorithm described in Section 4.2.2 to schedule channel exploration. Same adaptation techniques in the exploration rate and step size are used.

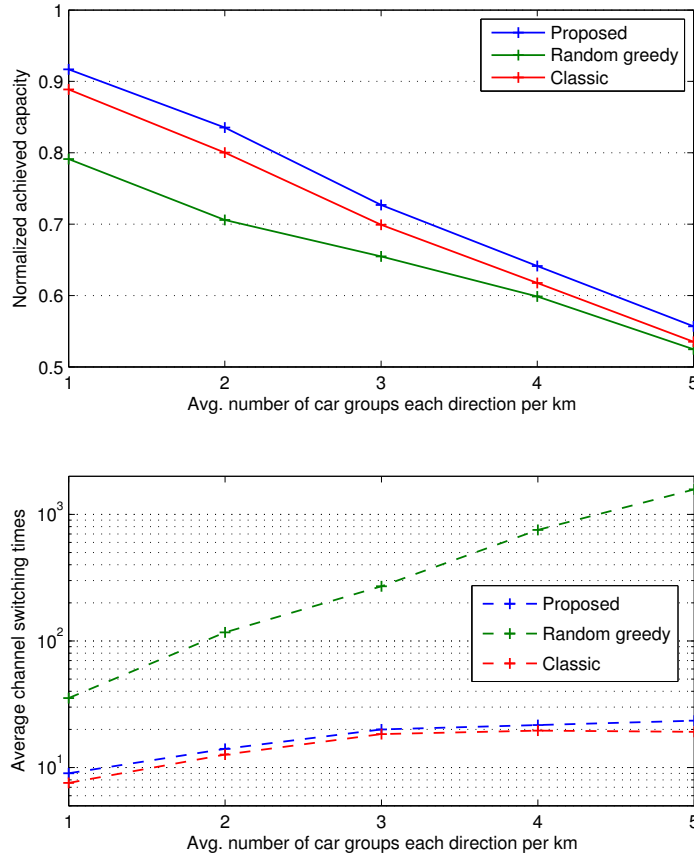

Figure 4.6: Performance comparison of three channel selection approaches in terms of (a) normalized throughput and (b) average switching times.

4.3. EVALUATION IN SHARED TV WHITESPACE

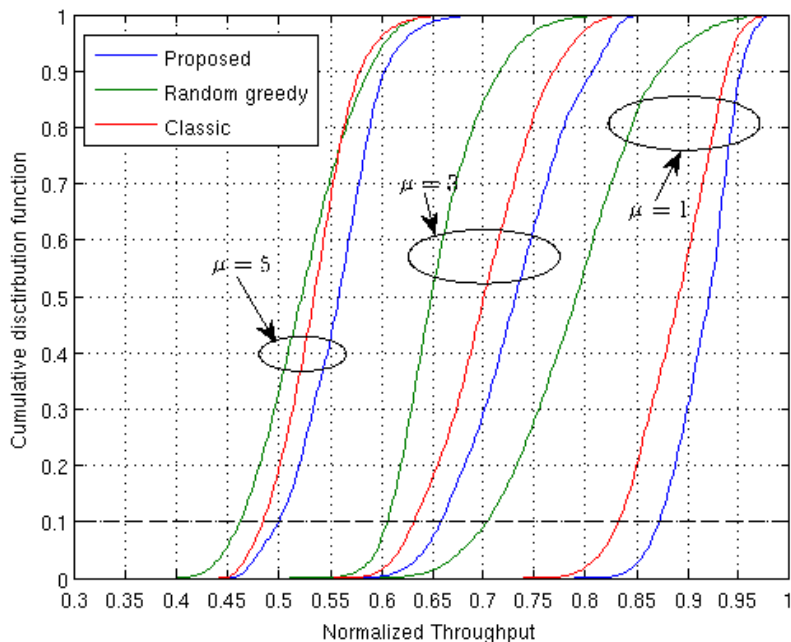

Figure 4.7: CDF of achieved throughput. μ is the average number of car groups in each direction/km.

Three metrics are used to compare the performance of the above approaches. The normalized throughput is calculated as the total achieved channel reward divided by the maximum channel capacity of an empty channel. The channel switching time cost, which can be as long as 2 seconds [39] depending on other implementation issues, is not deducted from the calculation of normalized throughput. Nevertheless, combining the results of normalized throughput and average channel switching times, the reader will be able to get a better understanding of the actual achievable throughput. The average number of channel switching times counts the times that an agent switch its accessing channel but not its sensing channel (exploration channel). Unlike switching the communication channel, the switching of a sensing channel can be accomplished instantly. The major time consumption in a network is due to switching the communication channel. The higher the channel switching times, the lower the time ratio for actual communications. The last metric is outage probability, which measures the probability of the achieved total channel reward falling below a certain threshold. This metric reflects the distribution of the achieved throughput over multiple runs.

Figure 4.6 shows the comparison results of above three metrics. While the throughput of all three approaches decline as the vehicle traffic increases, adaptive approaches always perform better and UCB controlled channel exploration performs the best. The difference between the naive approach and the adaptive approaches is significant in terms of channel switching times. While the channel switching times of the naive greedy approach increases exponentially as vehicle density increases, the adaptive approaches can maintain an acceptable switching times. The slightly higher number of channel switching times of the UCB controlled channel exploration may be caused by the better capability of finding a better channel compared to the random channel exploration.

The cumulative distributions of the achieved throughput of all three approaches are given in Figure 4.7. Three different traffic levels are employed with μ , the average number of car groups in each direction per kilometer, taking on values of 1, 3, and 5. Comparing the CDFs with different traffic levels, we can see more significant advantages of applying learning to channel selection in more crowded traffic.

4.4 Summary

In this chapter, we have proposed an architecture tailored for vehicle communications in order to enable automatic learning of the wireless environment. The learning capability of a vehicle is not only feasible due to the increasing computational power installed on modern vehicles but also necessary due to the long product life time and fast varying environment. In particular we implement the proposed learning architecture to achieve the intelligence needed for the adaptive channel selection problem in dynamic spectrum access of vehicle communications. A reinforcement learning approach is used here as an example, although other machine learning methods can be adopted in the architecture as well. Simulation results show significant improvement of channel access time and a reduction in channel switching time in a realistic and highly dynamic environment.

Chapter 5

Cooperative Communication in Vehicular Communications*

When multiple cars traveling together are equipped with wireless communication devices, they naturally form an antenna array that could potentially enable cooperative communication to enhance connectivity with both distant cellular towers and other vehicles. Figure 5.1 depicts this concept where each user is an automobile. Closely located automobiles form a subnetwork and strategically use their independent channels to maximize the overall connectivity. The benefits of cooperative communication have been widely studied and a short survey can be found in Section 2.6. However, such ideal scenario may not always take place in a distributedly organized ad hoc network of cars. Cars may form multiple subnetworks and therefore compete with each other for channel access.

In this chapter, we analyze and present simulation results of the impact of cooperation within a subnetwork of unlicensed users on the competition among two subnetworks of unlicensed users competing for spectrum access. The major contributions are:

- Detailed analysis of the changes in outage probabilities at different levels of traffic intensity within subnetworks based on the derivation of outage probabilities in [7]. An extensive set of simulation results for secondary groups with different densities is provided.
- Analysis of the impact of increasing primary user transmission power on the outage probabilities of secondary subnetworks from [7].

*This work has been published in parts in IEEE Pacific Rim Conference on Communications, Computers and Signal Processing [7].

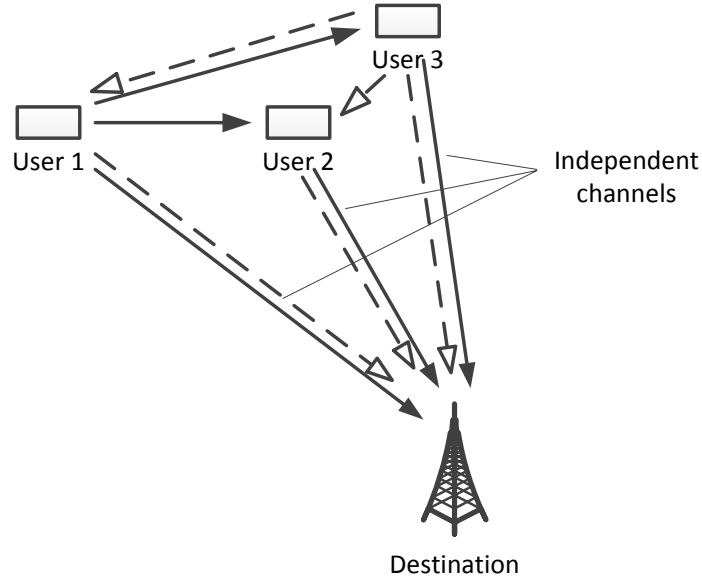

Figure 5.1: A diagram of cooperative communication where radios share antennas to relay signals for others.

- Two different power control rules on message forwarding are presented and their performance are compared through simulations.
- Relating the outage probabilities to the surviving users in competing secondary sub-networks. The competing process is evaluated where secondary users are aware of the environment and can autonomously switch channels.

5.1 System Model

The system we are considering in this dissertation consists of two unlicensed user groups competing for underlay access to the spectrum owned by a collection of primary users, as depicted in Figure 5.2. A typical primary subnetwork is a centralized network composed of a base station with high transmission power and several mobile users with less transmission power. While conforming to the primary user interference limit, each of the two secondary user groups tries to enhance its own performance. Although Figure 5.2 shows a centralized network structure for primary users and a mesh network structure for secondary users, the system can be generalized to include scenarios where both primary users and secondary users can adopt either centralized or mesh network structure.

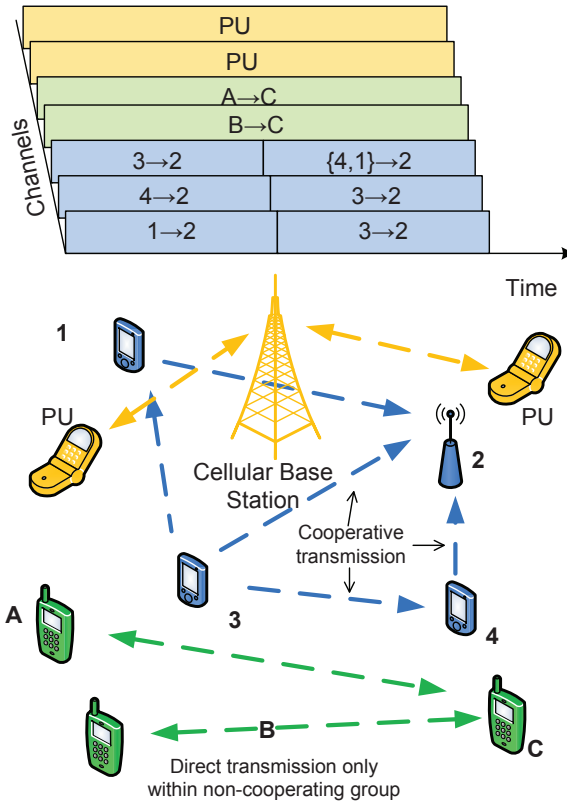

Figure 5.2: System model of spectrum sharing among primary user and secondary user groups. In underlay spectrum sharing mode without perfect time synchronization, channels are defined by spreading “pseudo-noise” (PN) codes and there is multiple access interference (MAI) among channels. If a user group uses cooperative transmission, the potential relays will use the second time slot to forward the bits they received during the first times slot by means of amplify-and-forward (AF) or decode-and-forward (DF).

Not necessarily all networks have the capability of synchronizing to a global time reference, hence in this dissertation we consider spectrum sharing via asynchronous multicode code division multiple access (MC-CDMA), which has been shown to be applicable to both centralized cellular networks and decentralized mesh networks [127]. In a typical primary network, such as a cellular network, a fast close loop power control and scheduling approach is employed to maintain a baseline signal to noise ratio at the base station. In a spectrum sharing scenario, due to the nature of the competition among different secondary user groups, it is difficult to employ such an approach since the users in one group possess no interests in reducing interference to the other group.

Although an overall cooperation is not feasible, a local cooperation among a subset of secondary users is still possible. In this case, we are considering one possible approach of intra-group cooperation, which is relaying signals for other users in the same group using an opportunistic decode-and-forward (ODF) [128, 129] described as follows.

Before each transmission, the source calculates a desired datarate R given available bandwidth B , and broadcasts an ask-for-help message including destination information and datarate of $2R$. The broadcasted datarate is $2R$ instead of R since the source will only be active during one of the two time slots if decode-and-forward is employed. In the case of slow fading channels, we assume same channel coefficients during the transmission of a message, which is composed of two time slots. Each potential relay that can successfully decode the message in the first time slot will respond to the source an acknowledgment if it can support a datarate of $2R$ toward the destination as well. In the case of fast fading channels, channel coefficients could be different for the two time slots, in which case each potential relay will respond to the source after successfully decoding the message in the first time slot, without conditioning on the datarate toward the destination node. In either scenario, if the source receives at least one response from possible relays, it initiates a cooperative transmission mode via a decode-and-forward strategy possessing a datarate of $2R$. Otherwise, the direct transmission (DT) mode with a datarate of R is employed. Each relay node uses the same spreading code as the source uses to forward the message, such that the numbers of codes used for ODF are the same as those used for non-cooperative direct transmissions. Users within the same group perform regular time synchronization among themselves such that the relayed copies of signals received at the destination are constructively combined.

Amplify-and-forward is another popular cooperation protocol, in which all group members participate in relaying received signals for the source. If each relay uses its full power

to forward messages, the total power spent on each message will be multiplied by the group size. Consequently, it will not be fair comparing to a non-cooperative group whose single-message energy consumption is limited to the transmitting power of a single device. In addition, amplify-and-forward produces amplified noise at the receiver in addition to forwarded message signals, which is not desirable in low SNR scenarios. In the ODF cooperation protocol, relays that can decode the message from the source will use the same spreading code to forward the message. Thus this protocol can be regarded as a combination of amplify-and-forward and decode-and-forward, where the decoding process at each potential relay serves as the mean of relay selection and noise mitigation.

In order to limit interference on primary users, the primary system sets up an initial maximum output power limit on each unlicensed user and sends additional messages to every secondary user on a broadcasting control channel in the event that the primary user is receiving too much interference. This simple procedure relieves primary base stations from frequent interaction with secondary users to set up individual maximal power level. When the primary user interference limit is not exceeded, there is a primary user interference margin that the secondary users can fill in by increasing their own signal power.

In this relay-based cooperative transmission scheme, transmissions are scheduled across two time slots. During the first time slot, the destination of a link (regardless of whether cooperative transmission is employed or not) receives:

$$y_{d(s)}(t_1) = \sum_{j \in \{S\}} h_{j,d(s)}(t_1) c_j(t_1) \sqrt{P_j} + z_{d(s)}(t_1), \quad (5.1)$$

where $d(s)$ is the destination of source s , $\{S\}$ is the set of active primary and secondary sources including s , the channel coefficient during t_k between user i and user j is denoted by $h_{i,j}(t_k)$ which captures the effects of path loss, shadowing and fading, c_i is the message of user i multiplied with its spreading code, P_i is the transmitting power of user i , and $z_{d(s)}(t_k)$ is the receiver noise during t_k .

In the second time slot t_2 , each secondary user in either group receives both the copies of the messages from all relay groups $\Gamma(s)$'s in the cooperating group and signals from sources using direct transmissions in both groups:

$$y_{d(s)}(t_2) = \sum_{i \in \{DF\}} \sum_{r \in \Gamma(i)} h_{r,d(s)}(t_2) c_i(t_1) \sqrt{P'_r} + z_{d(s)}(t_2) + \sum_{j \in \{S\} \setminus \{DF\}} h_{j,d(s)}(t_2) c_j(t_2) \sqrt{P_j}$$

where $\{DF\}$ contains the secondary sources that use relays, and $\Gamma(i)$ is the group of relays helping source i . P'_i is the amount of power that user i spends on each forwarded message.

The sum of power that user i spends on all simultaneously forwarded messages is equal the maximum output power limit P_i . We assume that $h(t_1)$ and $h(t_2)$ are identical in the scenarios of slow fading channels, and independent when the channels are fast fading.

For the case of Rayleigh fading, we model $h_{i,j}$ for the slot under consideration as complex Gaussian random variables with variance $\lambda_{i,j}$, such that $H_{i,j} = |h_{i,j}|^2$ are exponentially distributed with parameter $\lambda_{i,j}$. We also model $z_{d(s)}$ as zero-mean complex Gaussian with variance N .

5.2 Performance Analysis

In this section, we present the derivation of outage probabilities that a single secondary user can achieve a desired datarate R in both secondary groups when either both groups are using only direct transmission (DT) or one of the group is using opportunistic decode-and-forward (ODF). Both the primary user and secondary users are assumed to employ MC-CDMA across the same portion of spectrum with the same spreading gain denoted by G . Assuming Rayleigh fading, we model $h_{i,j}$ as complex Gaussian random variables with variance $\lambda_{i,j}$, such that $H_{i,j} = |h_{i,j}|^2$ is exponentially distributed with parameter $\lambda_{i,j}$. We also model $z_{d(s)}$ as zero-mean complex Gaussian variables with variance N . Since the bandwidth B here is the same for all users, we make the bandwidth equal to unity and omit it in the derivations.

5.2.1 Without Intra-group Cooperation

When neither of the unlicensed user groups employs cooperation, their outage probabilities for direct transmission can be expressed as:

$$\begin{aligned} \Pr[I_{\text{DT}} < R] &= \Pr[\log_2(1 + \text{SNR}) < R] \\ &= \Pr\left[\text{SNR} < \frac{2^R - 1}{G}\right] = \Pr\left[\frac{H_{i,d(i)}P_i}{N + J_i} < \frac{2^R - 1}{G}\right], \end{aligned} \quad (5.3)$$

where I_{DT} is the mutual information of direct transmission, J_i is the interference received by secondary link i , and R is the desired datarate in bps.

A simple power control scheme is employed by all secondary users in order to conform to the primary user interference constraint. All secondary users within the interference range of the primary user base station use the same transmission power level, and the total interference received by the primary user base station should not exceed the interference limit, *i.e.* $\sum P_i H_{i,p} < I$ where p denotes a primary users. We let K_p denote the set of

primary users, P_{p_i} denote the transmission power of primary user p_i , assume that all $H_{i,j}$ are independent and identically distributed with parameter λ , and assume there are k other secondary transmissions in the vicinity. And, we have for the total interference received by secondary link i :

$$J_i = \sum_{p_i \in K_p} H_{p_i,i} P_{p_i} + \sum_{j=1}^k H_{j,i} P, \quad (5.4)$$

where $H_{j,i}$ is an exponentially distributed random variable with parameter λ and $\sum_{j=1}^k H_{j,i}$ possesses an Erlang distribution with parameter λ and k . We assume that a power control scheme is employed by the primary user system in order to ensure that the minimal receiving SINR at the base station is satisfied for each user, hence P_{p_i} is inversely proportional to the transmission gain H_{p_i} between primary user p_i and base station.

5.2.2 Cooperative Group Performance Analysis

If one of the two groups uses ODF, then the outage probability for the cooperating group, denoted henceforth as group 1, is given as:

$$\Pr[I_{\text{ODF}} < R] = \Pr[I_{\text{DF}} < R, \text{DF}] + \Pr[I_{\text{DT}} < R, \text{DT}], \quad (5.5)$$

$$\begin{aligned} \Pr[I_{\text{DF}} < R, \text{DF}] &= \Pr[I_{\text{DF}} < R | \text{DF}] \Pr[\text{DF}] \\ &= \sum_{\Gamma(s)} \Pr[I_{\text{DF}} < R | \Gamma(s)] \Pr[\Gamma(s)], \end{aligned} \quad (5.6)$$

$$\Pr[I_{\text{DT}} < R, \text{DT}] = \Pr[I_{\text{DT}} < R | \text{DT}] \Pr[\text{DT}], \quad (5.7)$$

where $\Gamma(s)$ is the group of users that serve as relays for the source user. In the following, we show the derivations for the case when there is only one transmission in each user group for the sake of simplicity of representation. Consequently, each relay uses its full power to forward the message from the source ($P'_i = P_i$ for any $i \in \Gamma(s)$). The numerical simulation results of multiple concurrent transmissions are given in Section 5.3, where the transmission from each user is modeled as following a Poisson distribution and each relay distributes its power evenly among all the messages to be forwarded.

In an asynchronous CDMA system (*e.g.* cellular system), when all primary users have distinct transmission power levels regulated by a fast closed-loop power control scheme, the mathematical derivation for the outage probability is intractable. Hence, we only show the derivation when there is no primary activity in the network. Although there is no primary user transmissions, the competing nature between two secondary user groups is the same.

If we assume fast-fading channels such that $h(t_1)$ and $h(t_2)$ are independent, the relay selection is solely determined by the receiving signal strength at possible relay nodes. The probability that a user in the group can serve as a relay for the source user is the probability that it can decode a message from source at the datarate of $2R$, which is given as:

$$\begin{aligned}
 \Pr[r \in \Gamma(s)] &= \Pr[I_{s,r}^{\text{DT}} > 2R] = \Pr\left[\frac{H_{s,r}P}{N + H_{I,r}P} > \frac{2^{2R} - 1}{G}\right] \\
 &= \int_0^\infty \lambda e^{-\lambda x} \cdot \exp\left[-\frac{\lambda(2^{2R} - 1)(N + Px)}{PG}\right] dx \\
 &= \frac{G}{G - 1 + 2^{2R}} \cdot \exp\left[\frac{\lambda N(1 - 2^{2R})}{PG}\right], \tag{5.8}
 \end{aligned}$$

where $H_{I,r}$ is the sum of channel coefficients from the interferers, which in this case is the only source in the non-cooperative group, and $H_{s,r}$ is the channel coefficient between the source and the relay. All channel coefficients are assumed to follow the same distribution with parameter λ .

If we assume slow-fading channels where $h(t_1) = h(t_2)$ and potential relay nodes have perfect knowledge of the channel coefficients toward the destination, a node will choose to forward received messages only if it can support a datarate of $2R$ toward the destination. In that case, $\Pr[r \in \Gamma(s)]$ can be given as:

$$\begin{aligned}
 \Pr[r \in \Gamma(s)] &= \Pr[I_{s,r}^{\text{DT}} > 2R] \cdot \Pr[I_{r,d(s)}^{\text{DT}} > 2R] \\
 &= \Pr\left[\frac{H_{s,r}P}{N + H_{I,r}P} > \frac{2^{2R} - 1}{G}\right] \cdot \Pr\left[\frac{H_{r,d(s)}P}{N + H_{I,d(s)}P} > \frac{2^{2R} - 1}{G}\right] \\
 &= \left(\frac{G}{G - 1 + 2^{2R}} \cdot \exp\left[\frac{\lambda N(1 - 2^{2R})}{PG}\right]\right)^2, \tag{5.9}
 \end{aligned}$$

In either fast-fading or slow-fading channels, $\Pr[\Gamma(s)]$, the probability that a particular group $\Gamma(s)$ of user can serve as relays for the source, is then given as:

$$\Pr[\Gamma(s)] = \prod_{r \in \Gamma(s)} \Pr[r \in \Gamma(s)] \cdot \prod_{r \notin \Gamma(s)} \left(1 - \Pr[r \in \Gamma(s)]\right). \tag{5.10}$$

Since ODF falls back to direct transmission when there is no valid relay node, the probability of using direct transmission is given as $\Pr[\text{DT}] = \Pr[\Gamma(s) = \emptyset]$. The outage probability of a transmission from user s when a group $\Gamma(s)$ of users serve as relays, which

is the term of $\Pr[I_{\text{DF}} < R|\Gamma(s)]$ in Eq. (5.7), is given as:

$$\begin{aligned}
\Pr[I_{\text{DF}} < R|\Gamma(s)] &= \Pr \left[\frac{H_{s,d(s)}P + \sum_{r \in \Gamma(s)} H_{r,d(s)}P}{N + H_{I,d(s)}P} < \frac{2^{2R} - 1}{G} \right] \\
&= \int_0^\infty \Pr \left[H_{s,d(s)} + \sum_{r \in \Gamma(s)} H_{r,d(s)} = x \right] \cdot \Pr \left[H_{I,d(s)} > \frac{\frac{xPG}{2^{2R}-1} - N}{P} \right] dx \\
&= \int_0^\infty \frac{\lambda^{|\Gamma(s)|+1} x^{|\Gamma(s)|}}{(|\Gamma(s)|)! e^{\lambda x}} \cdot \exp \left[-\frac{\frac{xPG}{2^{2R}-1} - N}{P\lambda^{-1}} \right] dx \tag{5.11}
\end{aligned}$$

in fast-fading channels, where $H_{r,d(s)}$ is the channel coefficient between relay r and its destination, and $H_{I,d(s)}$ is the sum of channel coefficients from the interferers received at destination. In slow-fading channels, since a user only serves as relay if it can support a data rate of $2R$ both from the source and toward the destination, the outage probability $\Pr[I_{\text{DF}} < R|\Gamma(s)]$ is always zero theoretically. However, due to the activities of the other user group, the received interference could change between the two phases of ODF, hence the actual outage probability $\Pr[I_{\text{DF}} < R|\Gamma(s)]$ is nonzero. Consequently, the performance of using ODF scheme in a slow-fading channel is not always better than that of using only direct transmission. The numerical results will be given in Section 5.3.

5.2.3 Performance of the Non-cooperating Group

The non-cooperating group is assumed to use direct transmission for each source-destination pair all the time. The outage probability for the non-cooperating secondary user group, denoted as group 2, can be given as:

$$\Pr[I_2 < R] = \Pr \left[I_2 < R, \text{DF}_{\text{Group1}} \right] + \Pr \left[I_2 < R \mid \text{DT}_{\text{Group1}} \right] \Pr \left[\text{DT}_{\text{Group1}} \right], \tag{5.12}$$

where

$$\Pr \left[I_2 < R, \text{DF}_{\text{Group1}} \right] = \sum_{\Gamma_1(s_1)} \Pr \left[I_2 < R \mid \Gamma_1(s_1) \right] \Pr \left[\Gamma_1(s_1) \right],$$

I_2 is the mutual information of users in group 2, $\Pr[\text{DF}_{\text{Group1}}]$ is the probability that group 1 uses decode-and-forward, $\Gamma_1(s_1)$ is the group of relays for source s_1 in group 1, and $\Pr[\text{DT}_{\text{Group1}}]$ is the probability that group 1 uses direct transmission when there is no viable relay. The total probability is summed over the two conditions where the users in group 1 chooses to use relays or not.

Users in group 2, the non-cooperating group, receive different amounts of interference in the two time slots. In the first time slot, only the source in group 1 is transmitting, while

all the relays are transmitting in the second time slot. Since the source in group 2 sends independent pieces of information in the two time slots, we define the occurrence of outage as the event that outage happens in either one of the two time slots. Consequently, the outage probability of users in group 2 when users in group 1 are in the DT mode can be given as:

$$\Pr \left[I_2 < R | \Gamma_1(s) \right] = \Pr \left[\min(I_{2,1}, I_{2,2}) < \frac{R}{2} | \Gamma_1(s) \right], \quad (5.13)$$

where $I_{2,1}$ and $I_{2,2}$ are the mutual information for the source in group 2 in two time slots defined as:

$$I_{2,1} = \frac{1}{2} \log_2 \left(1 + \frac{GH_{s_2,d(s_2)}P}{N + H_{s_1,d(s_2)}P} \right) \quad (5.14)$$

$$I_{2,2} = \frac{1}{2} \log_2 \left(1 + \frac{GH_{s_2,d(s_2)}P}{N + P \sum_{r_1 \in \Gamma_1(s_1)} H_{r_1,d(s_2)}} \right), \quad (5.15)$$

where s_2 and $d(s_2)$ is the source and the destination in group 2.

$I_{2,1}$ and $I_{2,2}$ are calculated for different time slots, and the channel coefficients such as $H_{s_2,d(s_2)}$ are different random variables in $I_{2,1}$ and $I_{2,2}$ in fast fading channels. Statistically, it always holds that

$$I_{2,2} \leq I_{2,1},$$

because there are likely to be more than one active relays in group 1. We observe from the above results that the cooperating secondary group tends to cause higher interference to other users when assuming fixed transmission power for every user, while benefiting from multipath diversity. Such effects will be further illustrated with simulation results in the next section.

5.3 Simulation Results

In order to show the effects of intra-group cooperation on inter-group competition of unlicensed users, we simulated a network with a group of primary users and two groups of secondary users. The performance of users in each group are compared in terms of outage probability at different datarate. Since we assume the same amount bandwidth for all users, datarate R will be converted to spectral efficiency η (bit/s/Hz) in the numeric results as follows:

$$\eta = \frac{R(\text{Datarate})}{B(\text{Bandwidth})}. \quad (5.16)$$

We present results when the primary users are transmitting at different power levels and not transmitting. Each of the secondary users has an initial output power value. The primary user will broadcast warnings to the secondary users demanding a transmission power reduction when its received interference exceeds a threshold. The modulation of both primary users and secondary users is assumed to be CDMA with a spreading gain of 50. We assume a Rayleigh fading channel among all users in the network and the channel coefficients are independent and identically distributed exponential random variables with parameter $\lambda = 1$. Results of both fast fading channels and slow fading channels are presented and compared.

The primary users form a centralized network with nine mobile users and one base station that are all constantly transmitting and receiving. The transmission power of the base station is denoted by P_p , and the transmission power of mobile users are set to be 1% of P_p and divided by $H_{i,j}$, the squared magnitude of channel coefficients, between mobile users and the base station. The channels are assumed to be Rayleigh fading and $H_{i,j}$ follow an exponential distribution with a mean of 0.1. So when $P_p = 1$ W, the transmission power of mobile primary users will have a mean of 0.1 W. Each secondary group consists of same numbers of users, and the number of transmissions within a group follows Poisson distribution with parameter λ_{TX} . The cumulative amount of noise in the considered spectrum is 0.1 mW.

We first show in Figure 5.3 the outage probability of the two ten-user groups when there is on average one transmission in each group and no active primary user transmission in the network. The effects of adding more concurrent unlicensed transmission and primary user signal power will be shown in the following figures. Each of the ten users within the cooperating group will try to decode all signals from other users within the same group, and forward the message if the decoding at a data rate of $2R$ is successful. If we further divide a large cooperating group into two separate cooperating groups composed of 5 users, the performance of small cooperating groups lies between that of a large cooperating group and that of a purely competitive group. So we will omit the results of competition among smaller groups and focus on the scenarios of two ten-user groups.

We first show the results assuming fast fading channels in the network. Both analytical results as derived in Section 5.2 and simulated results are shown in Figure 5.3, which shows an acceptable match for both groups. As group 1 employs intra-group cooperation, the outage probabilities of both groups deviate from the baseline outage probability, which indicates the case where neither group employs intra-group cooperation. As the cooperating

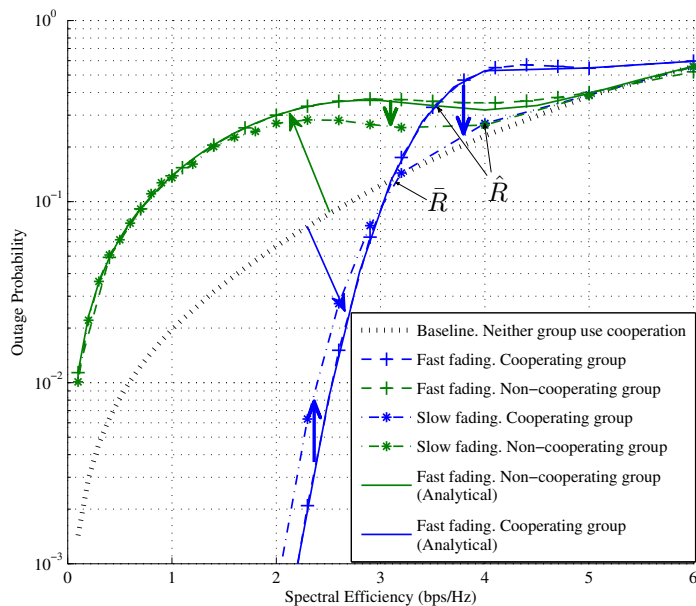

Figure 5.3: The change in outage probability if potential relays in the cooperating group have perfect knowledge of the channel condition toward the relay in a slow fading channel. There is a power limit on each device but no power consumption limit on each message, such that each user in the cooperating group can use its maximal allowed power to forward a message. The arrows indicate the changes in outage probabilities when one group starts using ODF.

group enjoys low outage probability at low datarate region, the other group that only uses direct transmission suffers a higher outage probability.

In order to better illustrate the performance difference, we define two crossing points of outage probability as follows:

$$\bar{R} = \arg\{\Pr_{\text{out}}^{\text{ODF}}(R) = \Pr_{\text{out}}^{\text{DT}}(R)\}, \quad (5.17)$$

$$\hat{R} = \arg\{\Pr_{\text{out}}^{\text{ODF}}(R) = \Pr_{\text{out}}^{\text{Non-coop}}(R)\}, \quad (5.18)$$

where $\Pr_{\text{out}}^{\text{ODF}}(R)$ is the outage probability of using ODF, $\Pr_{\text{out}}^{\text{DT}}(R)$ is of using direct transmission only, and $\Pr_{\text{out}}^{\text{Non-coop}}(R)$ is of the non-cooperating group. The two crossing points indicate the value of datarate R where the two outage probabilities are equal respectively.

It should be straightforward to prove that \hat{R} is always greater than \bar{R} . In the region $(0, \bar{R}]$, a user will more likely to receive a lower outage probability by using ODF than using only direct transmission. In the region of $(\bar{R}, \hat{R}]$, although a user using ODF has

greater chance to suffer higher outage probability than using only direct transmission, it will still enjoy lower outage probability than the other group that opts not to use ODF. Consequently, in the case where two groups of unlicensed users compete for the access to a specific channel, which happens often in dynamic spectrum sharing networks, a user still has incentives to use ODF in the region $(\bar{R}, \hat{R}]$ so that the other user group would suffer higher outage probability and eventually quit the channel.

In Figure 5.3, the outage performance of using ODF becomes worse than the group with only direct transmission for datarate beyond \bar{R} . This is because we assumed fast fading channels where potential relays have zero knowledge of channel conditions between the relays and the destination. In slow fading channels, poor outage performance can be prevented if each potential relay stores a list of channel conditions between the relay and other users within communication range, and chooses to forward a message only if it can support datarate of $2R$ toward the destination. Figure 5.3 also shows the performance of the cooperating group and the non-cooperating group when the potential relays in the cooperating group has perfect channel condition information assuming slow fading channels. The outage probability of the cooperating group now approaches close to the baseline in the region of datarate greater than \bar{R} . The other group will now have lower outage probability because only a subset of potential relays that can decode the message from source at datarate of $2R$ will forward the message, which means less interference to the other group.

Via intra-group cooperation, each user shares its antenna with the rest users within the same group. Consequently, when the regulation only poses constraint on single user output power level, it is possible the total power spent on a message will exceeds the maximum output power of a single user by employing several relay nodes to boost the total power. In the previous results, all users within a secondary user group can serve as potential relays, and each of them uses its full power to transmit relay messages. The low outage probability of the cooperating group is partly contributed by the higher power consumption. When there is a limit on the total power consumption on each message, the total transmission power spent on each message by all relays is the same as that of direct transmission.

$$P'_i = \frac{P_i}{M},$$

where M is the number of number of messages a node is relaying during the same time slot. We show in Figure 5.4 the results in such a situation. Slow fading channels are assumed in the results of Figure 5.4.

With a total power consumption limit on each message, the total transmission power of the cooperating group is constrained to be at the same level as the non-cooperating group

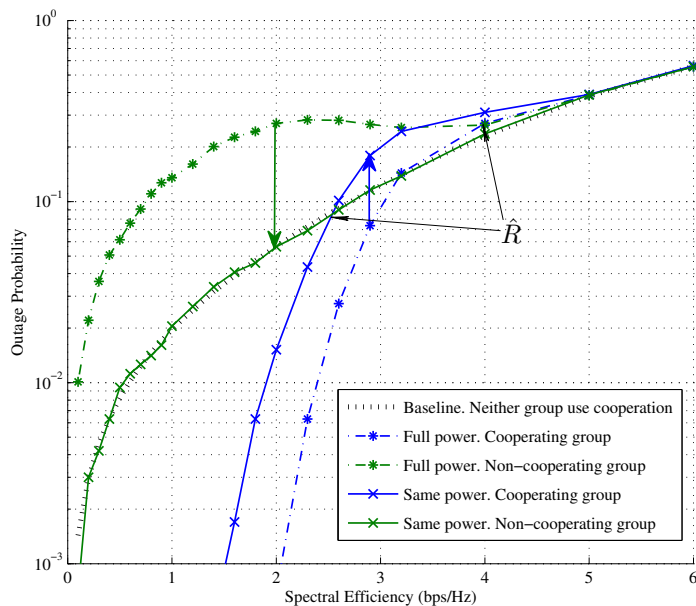

Figure 5.4: The arrows here indicate change of outage probabilities when there is a total power consumption limit on the transmission of each message in addition to output power limit on each device. In the “Same power” scenario, the total power spent on each message by all relays in ODF is constrained to be no more than that of direct transmission, while in the “Full power” scenario relays are allowed to use their full power to forward a message.

since both groups have the same number of transmissions. Consequently, the performance of the non-cooperating group approaches very close to the baseline when both groups are not employing intra-group cooperation. The value of \hat{R} , when the outage probability of the two groups are identical, is significantly reduced, which means the cooperating group now has less advantage over the non-cooperating group.

In Figure 5.5, we show the results when the mean number of transmission (λ_{TX}) in each unlicensed user group is more than 1, assuming no limit on the total power consumption on each transmission and fast fading channels. The value of \hat{R} when $P_{\text{out}}^{\text{ODF}}(R) = P_{\text{out}}^{\text{Non-coop}}(R)$ decreases as the mean number of transmissions increases due to higher cumulative interference. Although the cooperating group can still benefit from using ODF, the negative impact on the other group is reduced. When there are multiple concurrent transmissions, users in the non-cooperating group always receive high interference from multiple paths no matter the other group uses a relay-based cooperation or not. The total amount of interference is not significantly increased if relaying is employed by the cooperating group, since

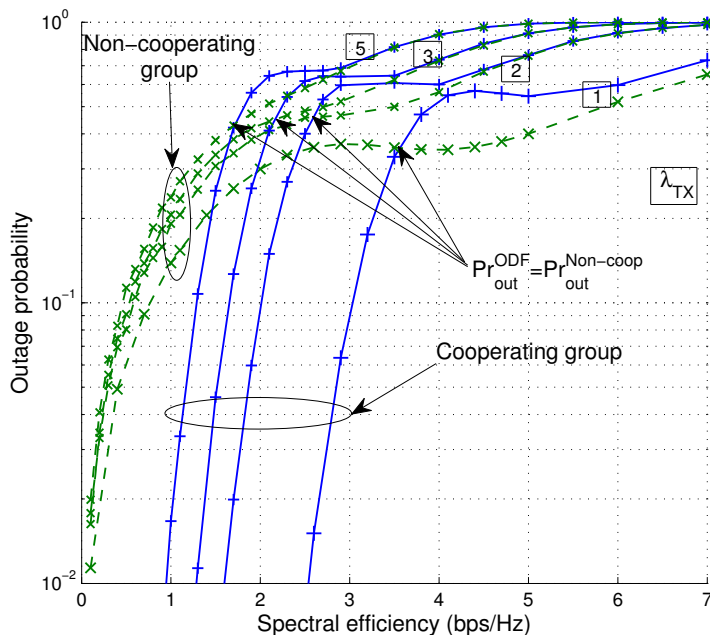

Figure 5.5: Outage probabilities of the cooperating group using ODF and the non-cooperating group when the average number of transmissions (λ_{TX}) increases from 1 to 5. Each group has 10 users and channels are assumed to be fast fading.

the maximum output power on each secondary user is limited.

The results when primary users have higher transmission power are shown in Figure 5.6 for P_p taking the values of 1 W, 2 W, and 4 W. These results are similar to the results of having more unlicensed user transmission as in Figure 5.5. Higher primary user transmission power causes higher outage probabilities for secondary users. The positions of both \bar{R} and \hat{R} are moved to lower data rate and higher outage probabilities as the primary user transmission power increases, while \hat{R} is always greater than \bar{R} . In summary, the increase of outage probability is mainly due to higher interference in the network regardless of whether the interference source is from primary users or secondary users.

In a spectrum sharing scenario where two groups of secondary user compete for spectrum access while conforming to primary user interference limit, a lower outage probability can directly affect the competition outcome. We show the influence using a simple competition protocol described as follows. A user in either the cooperating group or the non-cooperating group keeps a log of its past experience of transmission results, and quits the spectrum if it failed more than a certain percentage of the past transmission attempts. New messages only

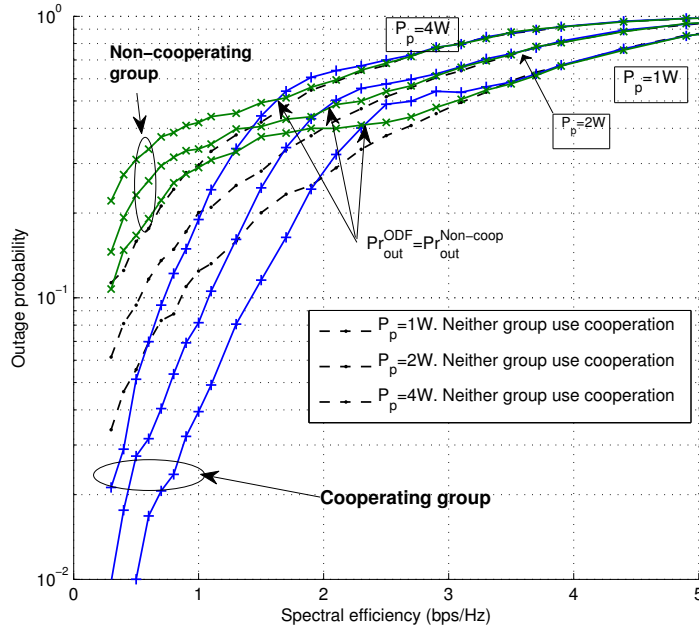

Figure 5.6: Outage probabilities of the cooperating group using ODF and the non-cooperating group when the primary user transmission powers increase (from [7]). Each group has 10 users and channels are assumed to be fast fading.

come from active users and only active users can relay signals. Assuming that every user obeys this protocol and there are same numbers of initial users in all groups, we compare the final numbers of active (surviving) users to show the outcome of the spectrum access competition.

In Figure 5.7, we show the average numbers of remaining active users in both secondary user groups for a range of datarates. The numbers of active users are counted after 100 seconds. The outage probabilities are dependent on the activities of users in both groups, and the numbers of users are changing depending on the numbers of outage occurrences of all users. In the “Same power” condition, the total power spent on each message by all relays in ODF is constrained to be no more than that of a direct transmission, while in the “Full power” condition relays are allowed to use their full power to forward a message. When there is no cooperation in either secondary group, we obtain a baseline of average numbers of remaining users denoted by the fine dotted line in Figure 5.7. Figure 5.7 shows the results with slow fading channels where relays have perfect knowledge of their channel coefficients toward the destination. There are 20 initial users in each group, each having a

Poisson distributed message arrival with a mean of 0.5 per second. There is also a group of primary users with one base station and 9 mobile users. The transmission power of primary base station is $P_p = 1 W$, and the transmission power of mobile primary users have a mean of 0.1 W.

From Figure 5.7, it is clear that the cooperating group always has more remaining active users then the non-cooperating group even when there is a limit on the total power consumption per message. When the relays in the cooperating group are allowed to spend full power in forwarding messages, while conforming to the output power limit on a single device, the advantage of using cooperation is more prominent. Figure 5.7 also shows that when one group employs intra-group cooperation the non-cooperating group will have less surviving users compared to the baseline number.

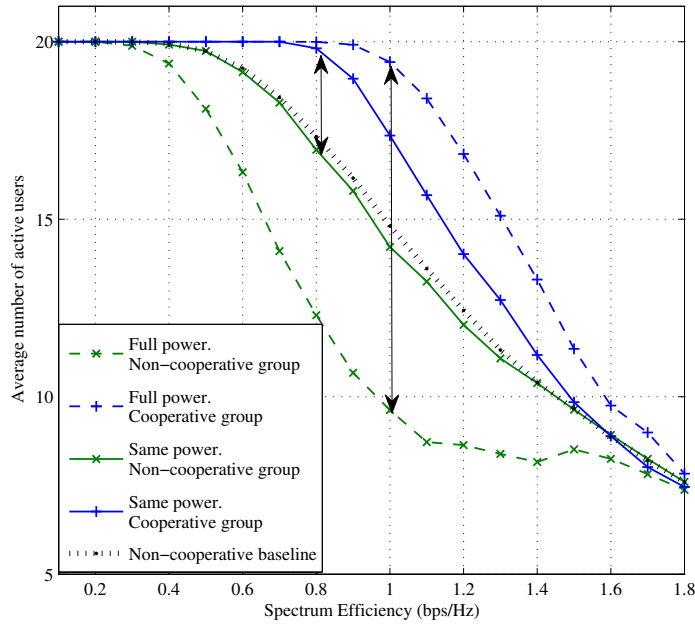

Figure 5.7: The average numbers of active surviving users from the competition of channel access in a slow fading channel. A user quits on receiving 10 or more instances of outage in the nearest past 20 transmission attempts.

5.4 Summary

In this chapter, we studied the spectrum sharing scenario among a group of primary users and two groups of secondary users. Such network formation has great potential in ad hoc wireless mesh networks with flexible spectrum regulation. Secondary users form groups to compete with other secondary user groups for spectrum access while conforming to the interference limit of the primary system. We analyzed the outage performance of competing secondary user groups and showed that using cooperative transmission within a user group can result in an increase in the outage probability seen by the competitor group and hence increase the surviving probability of the cooperating group itself.

Chapter 6

VDSA Implementation and On-road Experiments

With all the theoretical work and proposed ideas established above, it is the next logical step to bring this concept into real world. Therefore, we introduce in this chapter a testbed that realizes VDSA. This testbed brings us closer to actually applying cognitive radio technologies into vehicular communications.

6.1 Introduction

By incorporating secondary access to multiple frequency bands and the agility to adapt to the dynamic link condition and wireless environment, we proposed a scenario for future vehicular networking as shown in Figure 6.1. The general objective of this project is to use open channels for improving connectivity among vehicles. The performance metrics of measuring connectivity may vary depending on the application requirements. Typical metrics include throughput, delay, and communication range. While the connectivity can be enhanced from multiple aspects, focus on an approach of dynamic frequency channel selection in a mobile environment. A learning-based channel selection method was proposed [21] in order to facilitate adapting to the inconsistent channel occupation and channel utilization levels at different locations encountered by traveling vehicle networks.

A testbed was built and experimented on real roads in Japan [130] to experiment on the feasibility of using TV whitespace for inter-vehicle communication while avoiding interference with incumbent users. However, one limitation of this testbed in TV whitespace is that the experiment cannot account for interference from WLAN users, which is a major

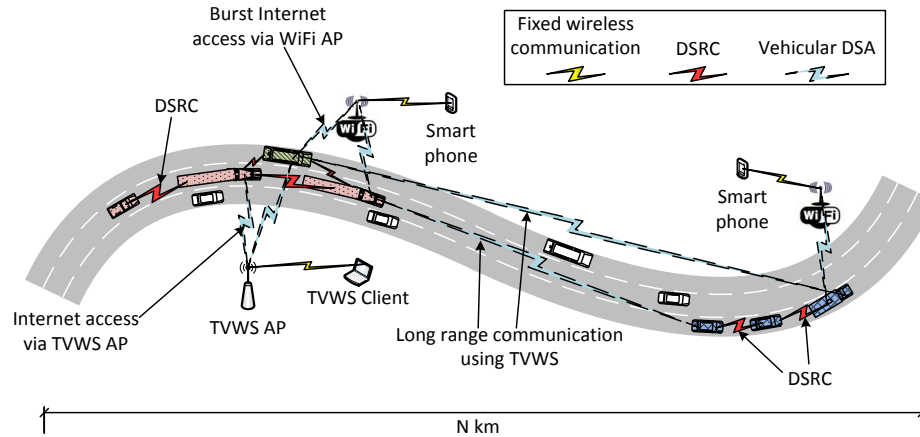

Figure 6.1: A vehicular dynamic spectrum access scenario where vehicles coexist with other wireless networks along the road.

component of wireless consumer products. Given the rapid development of standards for expanding WLANs to TV whitespace, we can expect the migration of WLAN traffic to TV whitespace. Therefore, it is desirable to conduct experiment in ISM bands in order to test the context awareness of vehicular communication devices. Studying networks in open spectrum bands will also provide insight on accessing other bands.

Another reason for conducting IEEE 802.11-based experiments is the trend of involving IEEE 802.11 standard into vehicular communication, such as IEEE 802.11p amendment, the most popular physical layer protocol for realizing inter-vehicle communications at the time of this paper.

The goal of channel selection may sound similar to the feature of Dynamic Frequency Selection (DFS) included in IEEE 802.11h [131], however, they have several differences. Firstly, DFS in IEEE 802.11h is designed to work in 5 GHz. Secondly, DFS only works for networks operating in infrastructure mode, while inter-vehicle networks work in ad hoc mode and need to cope with vehicle mobility.

The rest of this chapter is structured as follows. Section 6.2 describes the overall system design as well as details of its components. Section 6.3 lists and demonstrates the major features of this system including a few real-world experiments and the results are explained. Last but not the least, we summarize the open issues and future work of this testbed in Section 6.4.

6.2 System Design

The design of the testbed system is targeted at a distributed ad hoc communication network that can operate in real-world traffic condition. Each node platform of the network should be able to integrate into a regular automobile.

Figure 6.2 shows a concept diagram depicting the components of a single node in the network. The whole platform is divided into a radio subsystem and a UI subsystem in order to utilize both the radio hardware extensibility of networking boards and the ease of software integration on a PC with more computational power. For the current version of the testbed, the radio subsystem is implemented on Gateworks Cambria GW2358-4 [132], and the interface subsystem is implemented on a PC. The two subsystems are connected using sockets for any information exchange.

Context database is where all context information is stored, such as AP information and history of channel utilization. Considering the expected large volume of a complete database when the network size grows, we split the database into a global database with all context information and a cached database which only contains a subset of context information that is geographically relevant to a projected itinerary.

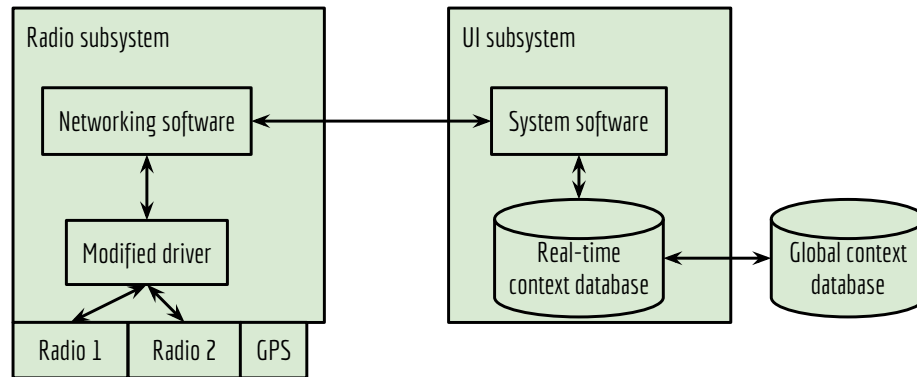

Figure 6.2: The system diagram of a node implementation for the testbed. The radio subsystem is implemented using a Gateworks board, and the UI subsystem is implemented on a PC.

6.2.1 Hardware Implementation

In order to test the context-aware multi-band system, a testbed of off-the-shelf hardware was utilized. Using Gateworks 2358-4 network platform boards, a testbed for vehicle-to-

vehicle and vehicle-to-infrastructure testing was created as shown in Figure 6.3. The Gateworks boards contain four Mini-PCI slots which is beneficial for performing data transmissions across multiple bands. We choose four distinct Mini-PCI radio modules from Ubiquiti Networks and XAGYL Communications to perform the tests. The multi-band portion of the testbed utilizes these four radio modules, each with a distinct frequency: 400 MHz, 900 MHz, 2.4 GHz, and 5 GHz. Typically, IEEE 802.11-based radios are only available in the 2.4 GHz and 5 GHz frequency ranges. However, these four radios all implement the IEEE 802.11 standard. Not only does this ensure protocol commonality across all four bands, but it allows us to utilize the existing IEEE 802.11 protocol stack. Additionally, the radio offer a substantial amount of transmit power (600 mW) which enables long distance data transfers to take place.

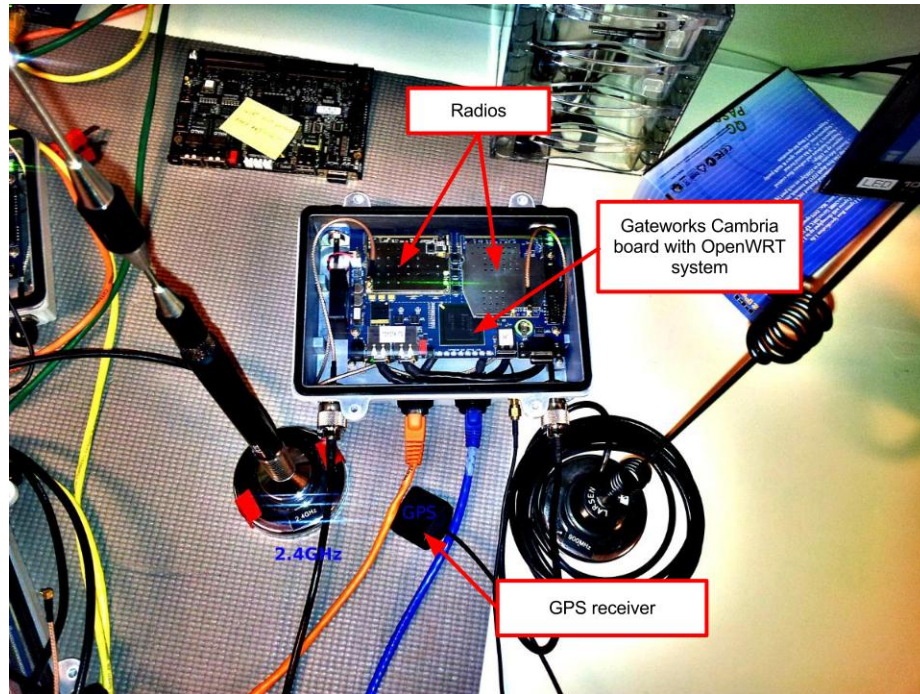

Figure 6.3: Hardware of the radio subsystem.

In order to perform V2V and V2I testing, we chose to use PCTEL and Larsen antennas with 5 dBi gain and magnetic antenna mounts. The antennas are mounted on the roofs of test cars (SUVs and sedans) with the magnetic mounts to secure the antennas, even at high speeds (60-70 mph).

For location information and time stamp synchronization, we use the 66800-52 GPS

antenna from Trimble Navigation. As with the data transmission antennas, the 66800-52 GPS antenna includes a built-in magnetic mount for fast and secure mounting to the roofs of our test cars.

6.2.2 Database Implementation

All of the data for this testbed was stored within a relational database. The data that was obtained by the boards and stored within their respective schema consisted of wireless information for the three different radio frequencies. This information was used to build the geotagged context awareness schema. The wireless information from the boards were broken into different tables that represented the surrounding road network. The continual collection of information on the test route resulted in the ability to perform historical analysis, leading to a report of which channels are busy or free in a selected area.

Since the AP-based channel scanning wardrive and the channel-based channel measurement generate data with different structures, they are stored separately. For the AP-based approach, scanning data comes in after every location update or every scanning cycle. Recorded features include BSSIDs of APs, signal levels, GPS coordinates, and GPS accuracy. Since most attributes of an AP are stationary, it would be a waste of space to store these constant values for every scan. Therefore, BSSID is used to identify an AP, and the constant attributes of APs are stored in a separate table. For channel measurement approach, data is stored every sample with attributes including time, channel, received packets per second, received bytes per second, channel busy time per second, GPS coordinates, and velocity. Snapshots of these tables are shown in Figure 6.4.

6.2.3 Channel Utilization Measurement

The goal of channel measurement in this system is to identify the congestion level of each channel, such that a single-channel ad-hoc network can strategically switch its operating channel to avoid congestion. ISM band in 2.4 GHz is heavily populated with a range of wireless communication devices under IEEE 802.11 standard as well as microwave ovens and personal area networks such as Bluetooth.

One approach is to derive an estimation of channel utilization based on the number of APs on each channel. Such information is commonly provided by most IEEE 802.11 devices via scanning beacons from APs. However, this approach has two major limitations: 1) it cannot account for interference from adjacent overlapping channels in 2.4 GHz band, and 2) the management frames that are consistently generated by APs is trivial compared with

6.2. SYSTEM DESIGN

bssid	level	lat	lon	altitude	accuracy
b0:e7:54:72:08:61	-76	37.40946219	-121.8644999	-6.700012207	5
20:4e:7f:69:a4:a1	-86	37.40946219	-121.8644999	-6.700012207	5
00:0f:b5:ec:c4:1c	-65	37.40946219	-121.8644999	-6.700012207	5
b0:e7:54:70:5e:39	-70	37.40946219	-121.8644999	-6.700012207	5
00:25:3c:90:de:d1	-71	37.40946219	-121.8644999	-6.700012207	5
34:ef:44:92:e2:11	-82	37.40946219	-121.8644999	-6.700012207	5
00:1a:c4:bf:22:09	-86	37.40946219	-121.8644999	-6.700012207	5
c0:3f:0e:76:3d:85	-83	37.40946219	-121.8644999	-6.700012207	5

(a)

bssid	ssid	frequency	capabilities	lasttime	lastlat	lastlon
b0:e7:54:72:08:61	Jumpman23	2437	[WPA-PSK-TKIP][ESS]	1344730364000	37.40951357	-121.8644061
20:4e:7f:69:a4:a1	ATT6986	2412	[WPA2-PSK-CCMP][ESS]	1344730380000	37.40953897	-121.8645463
00:0f:b5:ec:c4:1c	Mimi	2462	[WEP][ESS]	1344730250000	37.40971214	-121.8638558
b0:e7:54:70:5e:39	2WIRE941	2447	[WEP][ESS]	1344730364000	37.40951357	-121.8644061
00:25:3c:90:de:d1	2WIRE126	2422	[WEP][ESS]	1344730193000	37.41012624	-121.8637925
34:ef:44:92:e2:11	2WIRE819	2427	[WEP][ESS]	1344730330000	37.40973741	-121.8638727
00:1a:c4:bf:22:09	2WIRE992	2437	[WEP][ESS]	1344730364000	37.40951357	-121.8644061

(b)

	Date	Time	Channel	Packets	Bytes	Busy_ms	Lat	Lon	Vel
56860	2012-08-17	14:32:45	1	60	9960	180	37.389055	-122.049273	0
56861	2012-08-17	14:32:45	7	60	6540	260	37.389055	-122.049273	0
56862	2012-08-17	14:32:45	5	70	8320	370	37.389055	-122.049273	0
56863	2012-08-17	14:32:46	3	40	9600	330	37.389052	-122.049272	0
56864	2012-08-17	14:32:46	3	50	10230	470	37.389052	-122.049272	0
56865	2012-08-17	14:32:46	10	150	21740	300	37.389052	-122.049272	0
56866	2012-08-17	14:32:46	7	60	9580	180	37.389052	-122.049272	0
56867	2012-08-17	14:32:48	8	60	14570	430	37.389051	-122.049271	0
56868	2012-08-17	14:32:48	10	90	18720	290	37.389051	-122.049271	0

(c)

Figure 6.4: Snapshots of tables in the context database. (a) Location table. (b) AP table. (c) Channel utilization table.

data frames generated by dynamic communication demand from users, therefore numbers of APs cannot reflect the actual channel congestion level.

Another approach is to measure channel-based utilization level directly rather than AP-based information. We experimented with two methods. The first approach is to record all wireless packets on the channel and estimate channel utilization level. The corresponding limitations are: 1) it cannot account for non-802.11 radio sources, 2) it cannot account for corrupted frames that are discarded by radio driver, and 3) it is computationally expensive and is nearly impossible for real-time implementation. The second approach is to record statistics at radio hardware level. The limitations are: 1) the implementation of channel

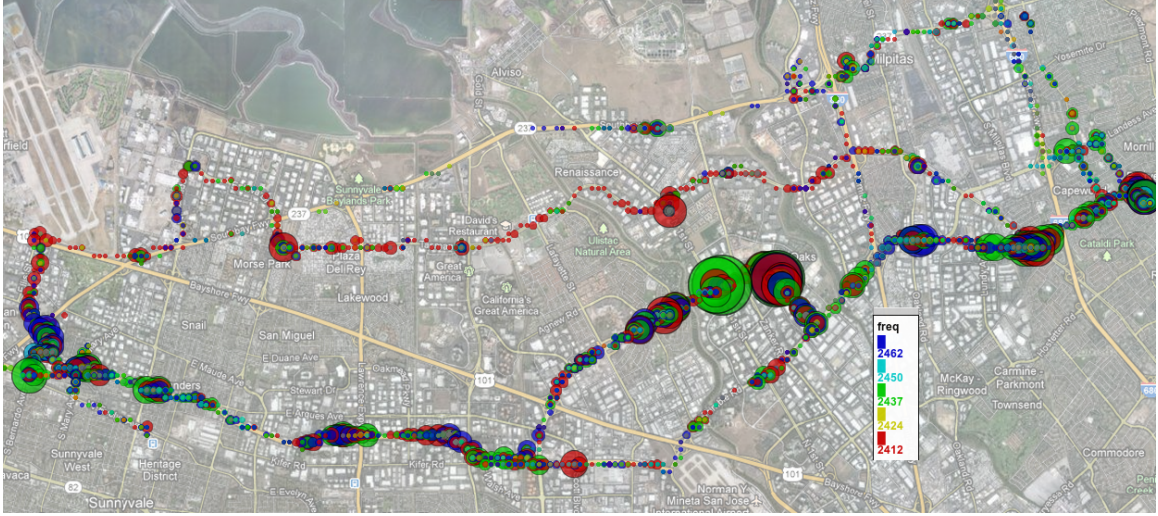

Figure 6.5: Distribution of APs over channels at different locations. The sizes of circles indicate numbers of APs per channel. The maximal number of scanned APs per channel is 30.

measurement is driver-specific therefore not portable, and 2) the memory space for driver is very limited and only simple calculations can be implemented.

In order to estimate channel busy time from packet sniffing record, additional processing is needed to account for the overhead of CSMA/CA. The DIFS and SIFS defined in IEEE 802.11 standard should be included when calculating channel busy time, but these period are not directly recorded in any packet sniffing record. What's not available from packet sniffing record also include the exponential backoff time experienced by each node. During such period, the channel is actively utilized even though there might not be signal transmitted over the medium. An estimation approach was proposed in [133], where the estimation algorithm is tested in a controlled isolated wireless environment and an accuracy of less than 0.1% was presented.

Either of these two approaches can produce channel measurements in the forms of correctly received packets and bytes and channel busy time. Given a sample time of 100 ms, the values of these three measurements all have large variations. The correlation values between the three measurements for a sample size of 3000 per channel are shown in Table 6.1.

After adding a moving average filter of length 20, we can obtain a more clustered scatter plot of received bytes and channel busy time as shown in Figure 6.6, and the distinction between busy channels and idle channels is much clearer.

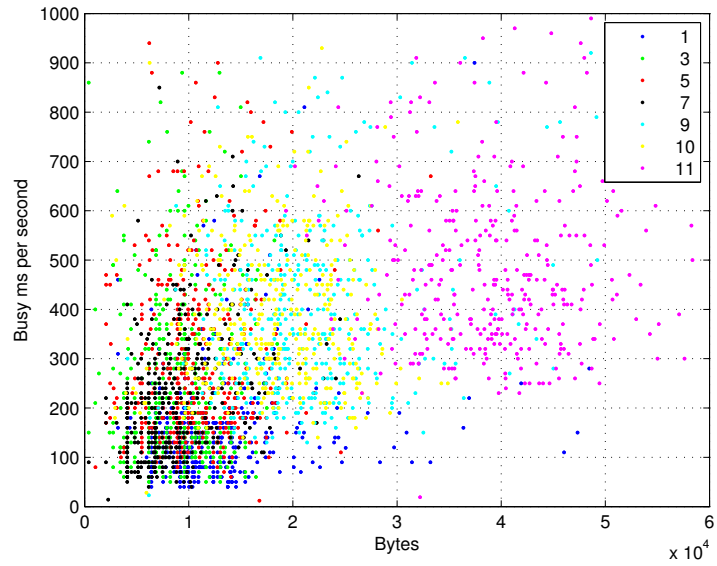

(a)

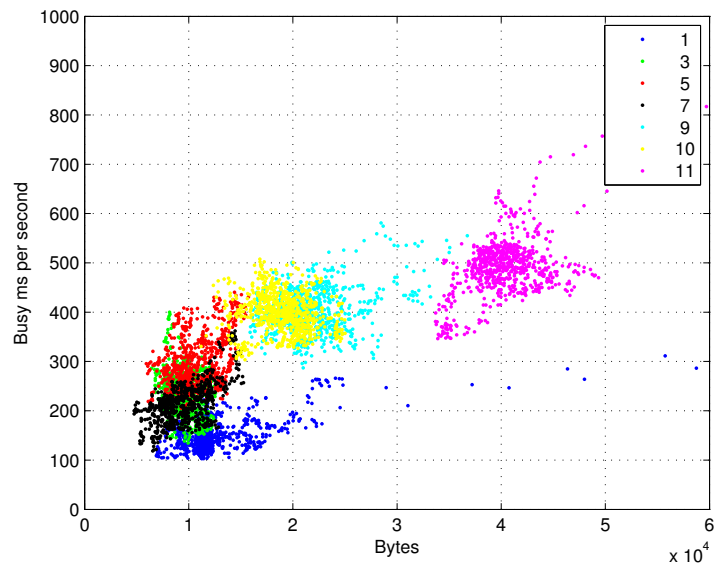

(b)

Figure 6.6: Measurements of received bytes and channel busy time. (a) Raw measurements. (b) Data filtered through a moving average of 20 samples.

Table 6.1: Correlation values between channel measurements.

Measurements	Correlation per channel
(Packets, Bytes)	Min: 0.8337 Max: 0.8981
(Bytes, Busy time)	Min: 0.2086 Max: 0.3562

Note that our goal is to identify the congested channels, for example the channel 9, 10, and 11 in Figure 6.6, therefore it is not necessary at this moment to accurately estimate the utilization level of a channel as long as there is enough distinction between busy and idle channels. Judging from Figure 6.6, we decided to use the number of received bytes as an indication of channel congestion level.

6.2.4 Driver Issues and Modification

Both *ath5k* and *MadWifi* drivers can be used to access the *athero*-based radios installed on this testbed. While both drivers support *ad hoc* mode of IEEE 802.11 standard, they bear several differences in terms of behavior. Some of the differences we found that are relevant to this project are summarized in Table 6.2.

Table 6.2: Feature comparison between *ath5k* driver and *MadWifi* driver.

	MadWifi	ath5k
Channel switching time	0.01s	0.06s
Switching behavior	Keep BSSID and SSID	Leave current network 7s to create a new one
Beacon behavior	Always on	Stop after 30s if no neighbor
Statistics	No full iw support	iw survey dump channel busy time

iw is a set of configuration tools for accessing wireless drivers in Linux. Using `iw survey dump` command, we can access the statistics of channel busy time measured by the driver if this feature is implemented. Below is an example output of `iw survey dump` command.

```
root@OpenWrt:~# iw dev wlan0 survey dump
Survey data from wlan0
frequency:                2412 MHz
noise:                    -90 dBm
channel active time:      45 ms
channel busy time:        21 ms
channel receive time:     2 ms
```

```

channel transmit time:      0 ms
Survey data from wlan0
frequency:                  2417 MHz
Survey data from wlan0
frequency:                  2422 MHz [in use]
noise:                      -90 dBm
channel active time:       7277919 ms
channel busy time:         1217936 ms
channel receive time:      405999 ms
channel transmit time:     151307 ms

```

Running `iw` command, however, is not the most efficient way of obtaining statistics. In real test, it takes over 0.03 second on Gateworks 2358-4 boards. Since every sample needs to run the command twice, one at beginning and the other at the end, running `iw` command requires an overhead over 0.06 second for each sample of 0.1 second. In order to cut down this overhead, we modified `ath5k` driver to make the statistics available via direct reading from `debugfs`, a special file system (technically referred as a kernel space-user-space interface) available in Linux kernel since version 2.6.10-rc3 [134].

While the ideal solution would be to customize the driver to fit our desired features, a temporary solution which avoids most driver modification works fine for our test at this stage. The workaround is to use `ath5k` to perform channel sensing and `MadWifi` to maintain beacons of an ad hoc network.

6.3 Feature Demonstration

6.3.1 Channel Measurement

In order to verify the effectiveness of measuring channel utilization levels while driving in real-world traffic, we did a test drive near downtown Mountain View in the state of California. The GPS track is shown in Figure 6.7.

Results from the test drive are shown in Figure 6.8. The normalized available channel capacity is an index defined based on correctly received bytes within 100 ms over a single channel from all sources. In Figure 6.13(b), a moving average window is applied to the raw measurement and a clear symmetry can be observed centered near the middle where we took a U-turn at the south end of downtown Mountain View then drove back on the same route. The symmetry indicates a potential consistency in the geographical distribution

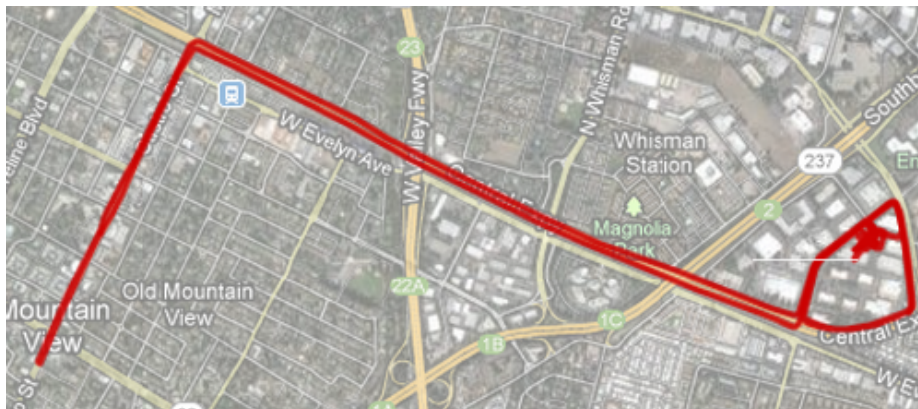

Figure 6.7: GPS track of a channel measurement test starting from near Central Exp on the right, via Mountain View on the left, and back to Central Exp.

of channel utilization level, even though the temporal variation causes significant amount of noise in channel utilization. A more comprehensive channel measurement over a wider range of locations and time is necessary to capture the complete characteristics of channel utilization, however that is beyond the scope of this thesis given the available resources and time.

6.3.2 Channel Synchronization

In order to avoid channel congestion or jamming in IEEE 802.11-based networks, multi-channel MAC and automatic channel switching has been studied as a potential solution. However, there has not been a unified solution for channel switching in all network scenarios. Channel switching and synchronization is not yet a standard feature defined in IEEE 802.11. A channel hopping approach similar to the pseudo random channel hopping used in Bluetooth is used in [135] in order to avoid jamming. IEEE 1609.4 [136] uses a synchronized channel hopping between a control channel and a service channel. While these two approaches can achieve channel switching and synchronization delay of less than 10 ms, both of them follow a predetermined timing and sequence for channel switching and cannot actively detect channel congestion or jamming. In [137], the authors proposed a dynamic channel switching approach for wireless mesh networks to avoid congested channel at different locations. However, this approach is not designed for a dynamic environment with varying channel congestion levels and it also used a synchronized slotted timing mechanism to synchronize channel switching operation.

6.3. FEATURE DEMONSTRATION

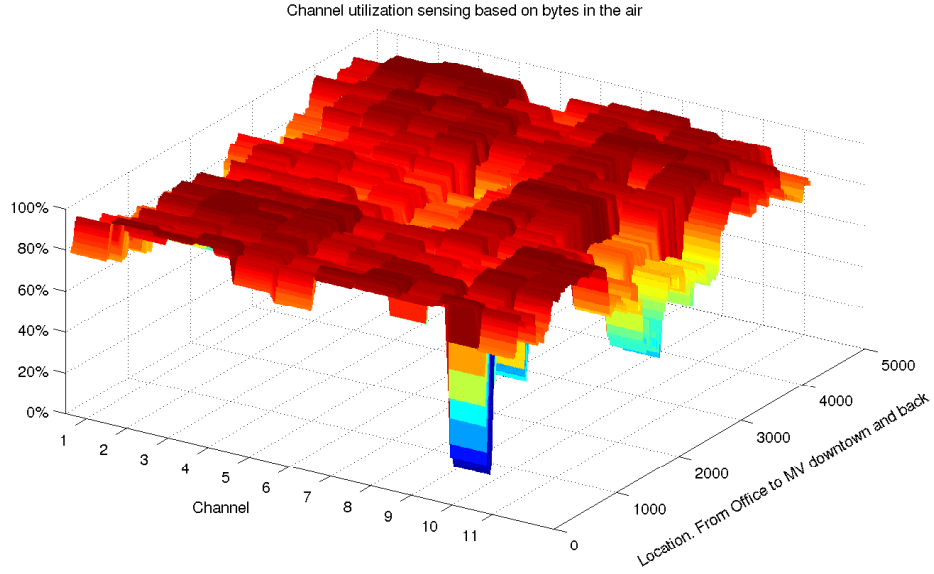

(a)

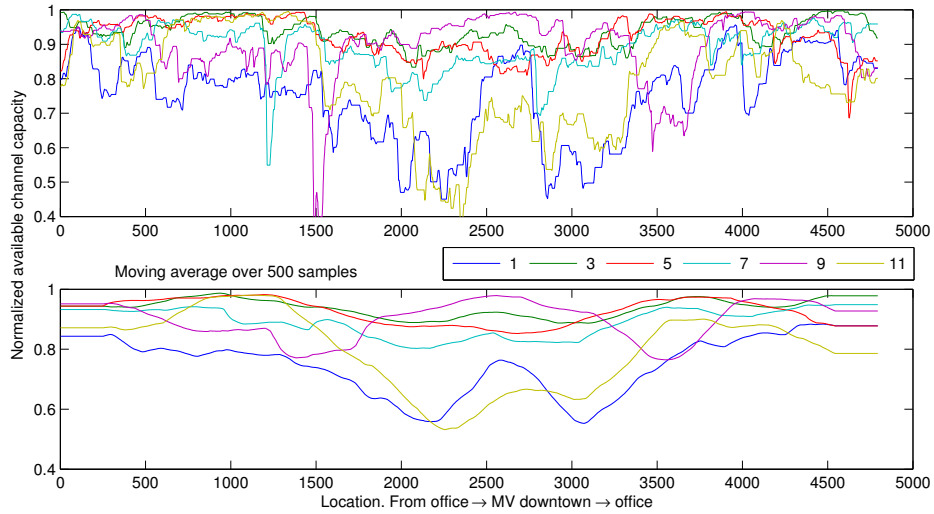

(b)

Figure 6.8: (a) Normalized available channel capacity of all channels in 2.4 GHz, (b) Normalized raw available channel capacity and the moving average of the raw measurement.

In order to realize context-aware dynamic channel switching for an ad hoc network traveling on real roads, we are looking at an on-demand channel switching protocol based without AP coordination. We use the standard IEEE 802.11 physical layer and MAC layer, which is based on asynchronous packet-based communication. The protocol is implemented in the user space that is independent of lower layer implementation and no specially designed

hardware is needed. Depending on the channel switching behavior of the wireless driver on a single node, the performance of channel switching over a wireless link will vary. For example, *madwifi* allows for changing the channel of an ad-hoc network without changing the BSSID or disassociation from a network, while *ath5k* will automatically disassociate from an ad-hoc network whenever handling a request from user space to change channel.

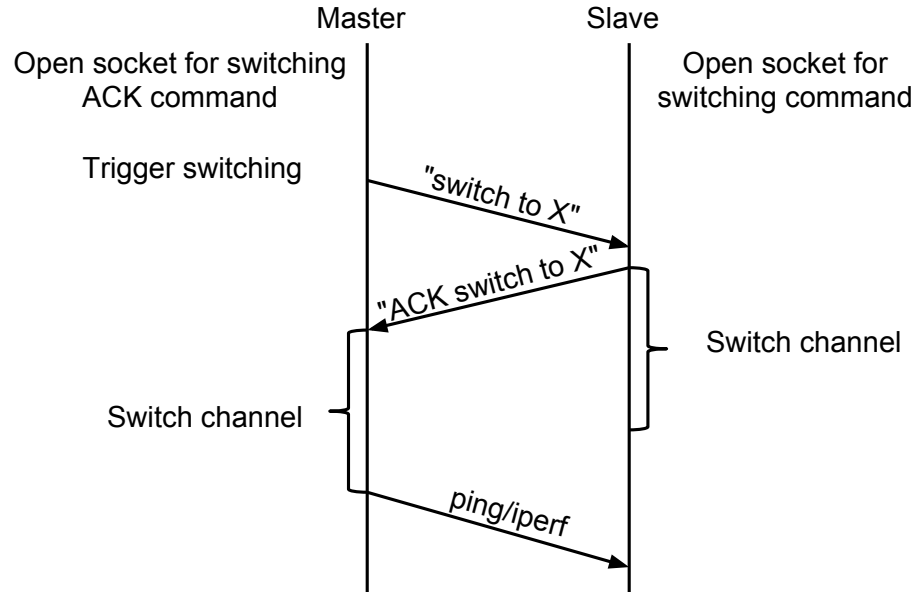

Figure 6.9: Channel switching protocol for a wireless ad hoc link.

Figure 6.9 illustrates the on-demand switching protocol between two nodes. The “Master” node represents any node that is responsible for making the decision of switching to a new channel. For example, it can be the node serving as the virtual AP in WiFi Direct, or the node that is responsible for sensing channel congestion level of the environment. The “Slave” node represents any node that follows a channel switching command. The protocol is implemented as a background process running on the radio subsystem. A channel switching process starts with the “Master” node sending channel switching command to the “Slave” node, which has a background process waiting for such command. Then the “Slave” node responds with an acknowledgment and switches to the new channel. On receiving the acknowledgment, the “Master” node switches channel and return “success” to the main process that requested a channel switching operation. The two signaling messages themselves are implemented using socket to provide another level of error checking. The whole operation is verified by a `ping` command in the end.

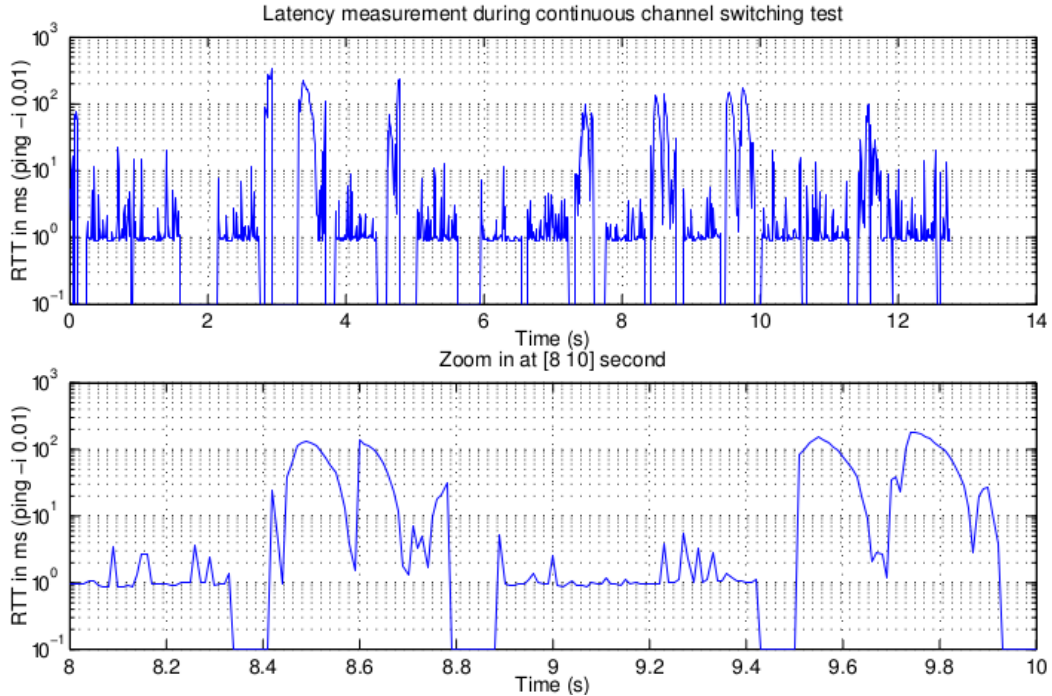

Figure 6.10: Measurement of channel switching operation over a wireless ad hoc link.

In order to measure the performance of the channel switching protocol, we record the round trip time (RTT) over a wireless ad hoc link while continuously switching channel. The result is shown in Figure 6.10. The round trip time is measured using a `ping` command running at 100 Hz. The channel switching sequence is randomly generated on the fly. The gaps between valid RTT values in the recording indicate when the network link is broken due to channel switching.

This wireless link is established using WiFi ad-hoc mode between a “Slave” node using *madwifi* and a “Master” node using *ath5k*. The “Slave” will continue using the same BSSID immediately after switching to a new channel, and the “Master” disassociates from the ad-hoc network on the old channel and uses beacons broadcasted by the “Slave” on the new channel to join the migrated ad-hoc network.

6.3.3 Channel Adaptation

One problem specific to inter-vehicle networking is the dynamic wireless environment due to the vehicle mobility and geographical heterogeneity in channel conditions. In addition, while there is significant mutual interference between local stationary wireless networks

6.3. FEATURE DEMONSTRATION

and mobile vehicular networks, there has not been any attempt to coordinate these two types of networks in either centralized or distributed fashion in order to mitigate congestion. Therefore, vehicular networks, especially inter-vehicle links, will experience fluctuating channel congestion level as a combined result of temporal variation due to user activity and geographical heterogeneity of local wireless networks. Instead of optimizing network parameters to minimize interference, tuning parameters in physical layer may be feasible to avoid congestion. Figure 6.11 shows an example of changing operating frequency channel so as to avoid interference with local wireless networks.

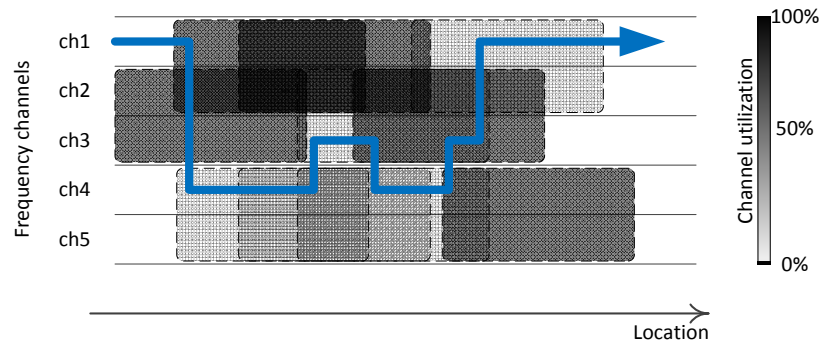

Figure 6.11: Expected channel selection outcome.

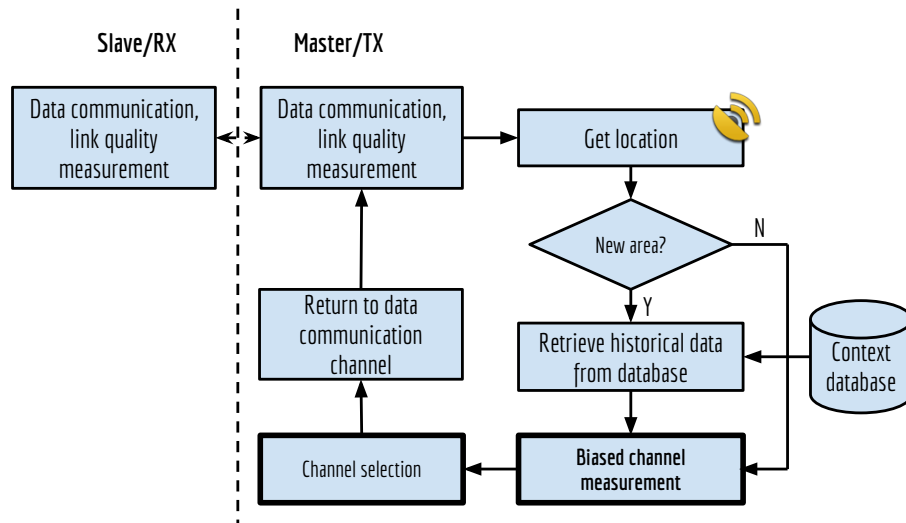

Figure 6.12: Process flowchart of the channel adaptation test.

6.3. FEATURE DEMONSTRATION

Using the channel measurement and channel hopping functions described in the previously, implemented an adaptively channel selection system to achieve the concept depicted in Figure 6.11. The channel selection testbed is shown in Figure 6.12. At the application level, link quality can be measured in terms of bandwidth and delay. Using a single-radio configuration for each node, channel utilization measurement and transmission cannot happen in parallel. In order to measure another frequency channel, the current transmission has to be paused so that the radio can be configured to operate on the frequency channel to be measured. While in real practice, channel measurement time can be scheduled in the natural gaps between active transmissions so as to avoid interrupting data communication, we use a fixed schedule in this test to allocate time between data communication and channel measurement.

When the vehicular network comes to a new area, it will retrieve from context database the historical data, which will contains previous channel measurement record, then a channel measurement process is run to collect samples of the current channel utilization levels. Given the limited time available for channel measurement, a biased scheduling method can be used to focus on less congested channels. Doing so will increase our confidence when identifying idle channels. Then a decision on whether to change data communication channel is made based on the estimated potential improvement in link quality.

A sample result of real-time channel selection is presented in Figure 6.13 where we did a roadtest on Middlefield road in Mountain View of California. The threshold of switching channel is set to be 5% increase in available channel capacity. From Figure 6.13(a), we can also clearly see that those channels with higher available capacities are sampled more often than those channels with low capacities. This biased sampling behavior is the result of applying the reinforcement learning algorithm we previously developed and presented in [21], where sampling time is proportionally concentrated toward those idler channels (with higher available capacity) so as to increase our confidence in the potential link qualities if we switch to these channels.

We also compared the round-trip time as an indication of connectivity between two cars. A sample result is shown in Figure 6.14. In this test, we picked channel 9 as the static channel as a control group to compare with. The performance metric used is round trip latency measured using `ping` command at 100 Hz with a packet size of 1500 kB over a duration of 3 second. For each sample, the latency values of the two channels in comparison were measured using the same transmitter pair successively so as to reduce the effect of environment change within the measuring duration of each sample. The test took place on

real road in the area of Mountain View at California. The result in this test shows that using dynamic channel selection offers a less frequent outage in the round-trip delay, while the link quality on channel 9 suffers from interference from local WiFi networks. However, more tests using different channels as control groups need to be carried out at multiple locations to reach a conclusive verdict.

6.4 Limitation, Open Issues, and Future Work

In this chapter, we described a testbed of realizing VDSA in real world. A context-aware multi-mode platform is brought up capable of sensing the environment and adjusting its own parameters to adapt to changes in the surrounding. While more features are yet to be implemented on this testbed, a primitive form of cognitive radio system is achieved.

Below are a few open issues that appeared during the course of developing this testbed, where future work is desired.

- A large scale channel utilization measurement campaign across time and location is needed in order to better understanding how the open spectrum is utilized.
- The standard ad hoc mode of IEEE 802.11 is insufficient for the desired environment-awareness. A new amendment enabling channel measurement and channel synchronization may be needed, the implementation of which will reside in the wireless driver.
- Dynamic frequency channel selection is one approach to solving local network congestion problem. Other variables, such as transmission range, transmission rate, and packet size can also be tuned adaptively to optimize connectivity performance. They are yet to be included in this testbed.
- For a better visualization of the benefit of cognitive radio, a video streaming application can be added on top of the existing architecture.

6.4. LIMITATION, OPEN ISSUES, AND FUTURE WORK

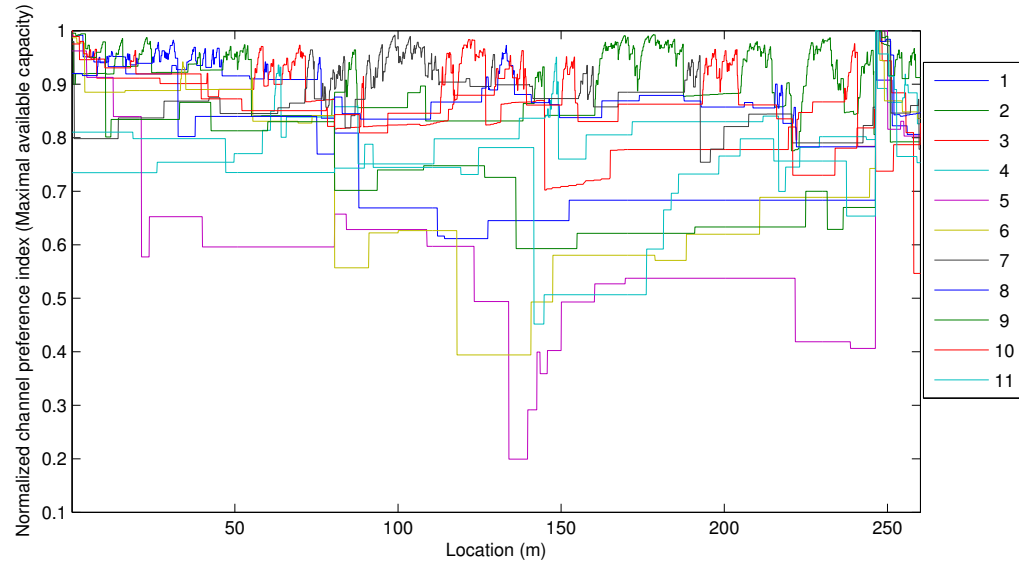

(a)

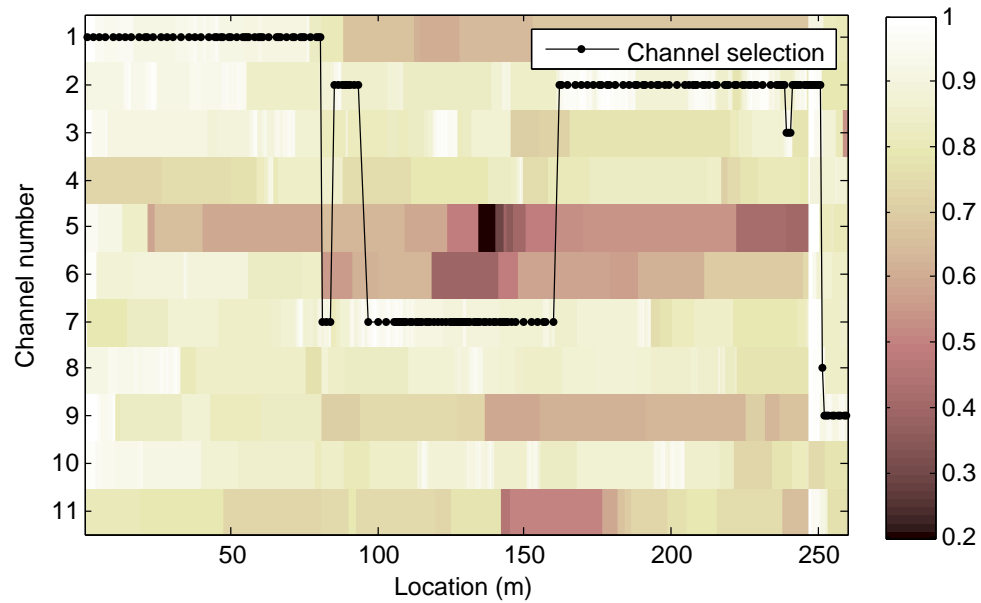

(b)

Figure 6.13: A sample result of a roadtest demonstrating dynamic channel selection. (a) Line plot of channel measurements. (b) Image plot of channel measurements. Line of channel selection shows how it avoids high interference.

6.4. LIMITATION, OPEN ISSUES, AND FUTURE WORK

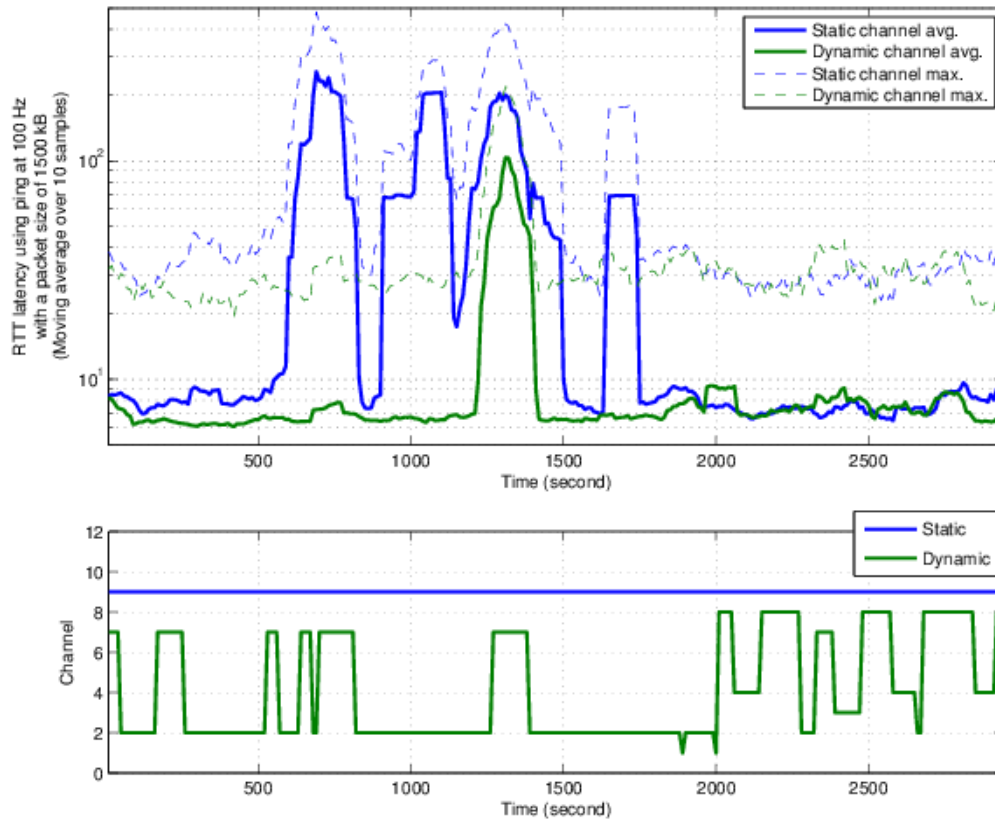

Figure 6.14: Performance comparison of round trip latency using ping between using a static channel and using dynamic channel selection during a road test. Static channel experiences higher packet latency due to interference from local WiFi networks, while dynamic channel selection can help avoid such interference.

Chapter 7

Conclusion

This dissertation presented an overview of cognitive radio technologies and vehicular communication systems. The state of the art and challenges of both were discussed, where cognitive radio technologies are in dire need of commercial applications and vehicle industry needs advanced information technology as new incentives for customers.

A thesis is raised that cognitive radio technology should be involved in designing a general-purpose (in contrast to only safety applications) wireless communication system for future vehicles. Such technologies include dynamic spectrum access, adaptive software-defined radios, and cooperative communications. While there has not been much cooperation between these two industries, a future cross-discipline development is promising and commercially attractive.

Three independent branches of research regarding applying cognitive radio technologies to vehicular communication systems were studied, which are feasibility study, artificial intelligence architecture, and cooperative communication. The artificial intelligence architecture has been implemented on a hardware testbed and experimented in real world to achieve dynamic channel selection on mobile vehicles. Learning benefits were demonstrated using results from both simulation and hardware experiments in real-world wireless network environment.

The results of quantitative feasibility analysis show that the TV white space is scarce in large cities such as Boston, where the average number of vehicles is also significantly higher than in suburban and rural area. These two factors collectively impair the feasibility of utilizing TV white space as a medium of vehicular communications. However, due to the high concentration of customers in large cities, various means of wireless access such as 3GPP Long Term Evolution (LTE) and a large number of WiFi hotspots can be expected

to exist. Hence vehicles will have the option of connecting to backbone infrastructure via existing wireless networks and offloading delay-tolerant applications from vehicle-to-vehicle communication links.

We have proposed an architecture tailored for vehicle communications in order to enable automatic learning of the wireless environment. A variety of possible opportunities for applying learning to cognitive radio is summarized in [22]. The learning capability of a vehicle is not only feasible due to the increasing computational power installed on modern vehicles but also necessary due to the long product life time and fast varying environment. In particular we implement the proposed learning architecture to achieve the intelligence needed for the adaptive channel selection problem in dynamic spectrum access of vehicle communications. A reinforcement learning approach is used here as an example, although other machine learning methods can be adopted in the architecture as well. Simulation results show significant improvement of channel access time and a reduction in channel switching time in a realistic and highly dynamic environment.

We studied the spectrum sharing scenario among a group of primary users and two groups of secondary users. Such network formation has great potential in ad hoc wireless mesh networks with flexible spectrum regulation. Secondary users form groups to compete with other secondary user groups for spectrum access while conforming to the interference limit of the primary system. We analyzed the outage performance of competing secondary user groups and showed that using cooperative transmission within a user group can result in an increase in the outage probability seen by the competitor group and hence increase the surviving probability of the cooperating group itself.

We described a testbed of realizing VDSA in real world. A context-aware multi-mode platform is brought up capable of sensing the environment and adjusting its own parameters to adapt to changes in the surrounding. While more features are yet to be implemented on this testbed, a primitive form of cognitive radio system is achieved. Real-world test of channel selection algorithm using this hardware testbed shows a significant reduction of packet latency compared to static channel that suffers from lack of awareness of channel busy levels.

Future vehicles are expected to recognize its wireless environment and decide intelligently how to distribute its communication demands to available wireless access options to enhance traveler experience. However, it is difficult to obtain an accurate estimation of throughput or delay performance of a wireless link in a short time due to the dynamic nature of wireless environment, contributed by high vehicle mobility as well as inconsistent data traffic of

other wireless users. Machine learning can be used to predict channel capacity according to both the instant channel sensing feedback and other environment information such as terrain and vehicle density.

Future Work While performance gain can be observed during real-world system test, the result is more of a proof of concept than a complete system. More hardware real-world tests need to be done in various scenarios to complement fully controlled software simulation in order to validate a working vehicular communication system. Furthermore, the same architecture can be slightly modified to enable cars to make use of open WiFi access points for opportunistic Internet access while traveling.

Dynamic frequency channel selection is one approach to solving local network congestion problem. Other variables, such as transmission range, transmission rate, and packet size can also be tuned adaptively to optimize connectivity performance. They are yet to be included in this testbed.

Appendix A

A MATLAB GUI Tool For Queueing Analysis

Figure A.2 is a screenshot of a self-developed tool using MATLAB with GUI in order to provide an effortless access to the analysis result using the queueing model developed in Section 3.2. The environment data is comprised of two part, the TV channel measurement data obtained from [5], as shown in Figure A.1, and average numbers of vehicles along I-90 collected from Google Maps.

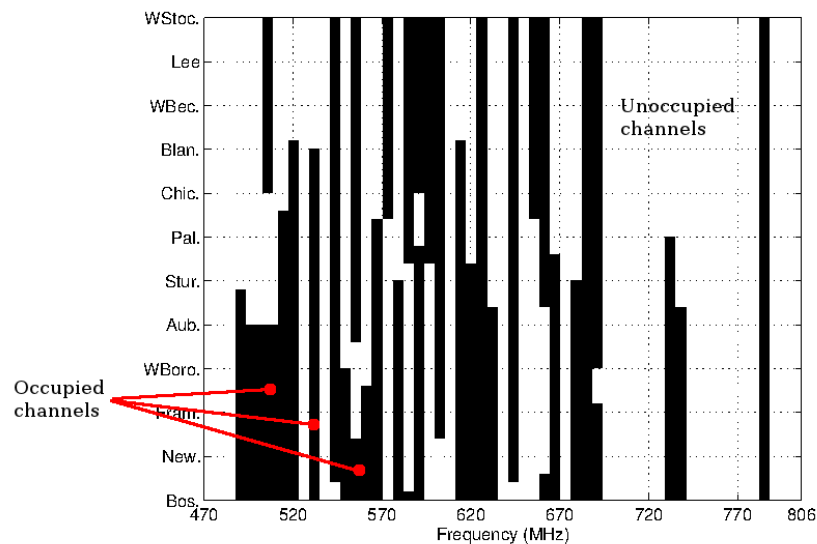

Figure A.1: TV Channel availability at different locations along I-90 in the state of Massachusetts, USA (from [5]).

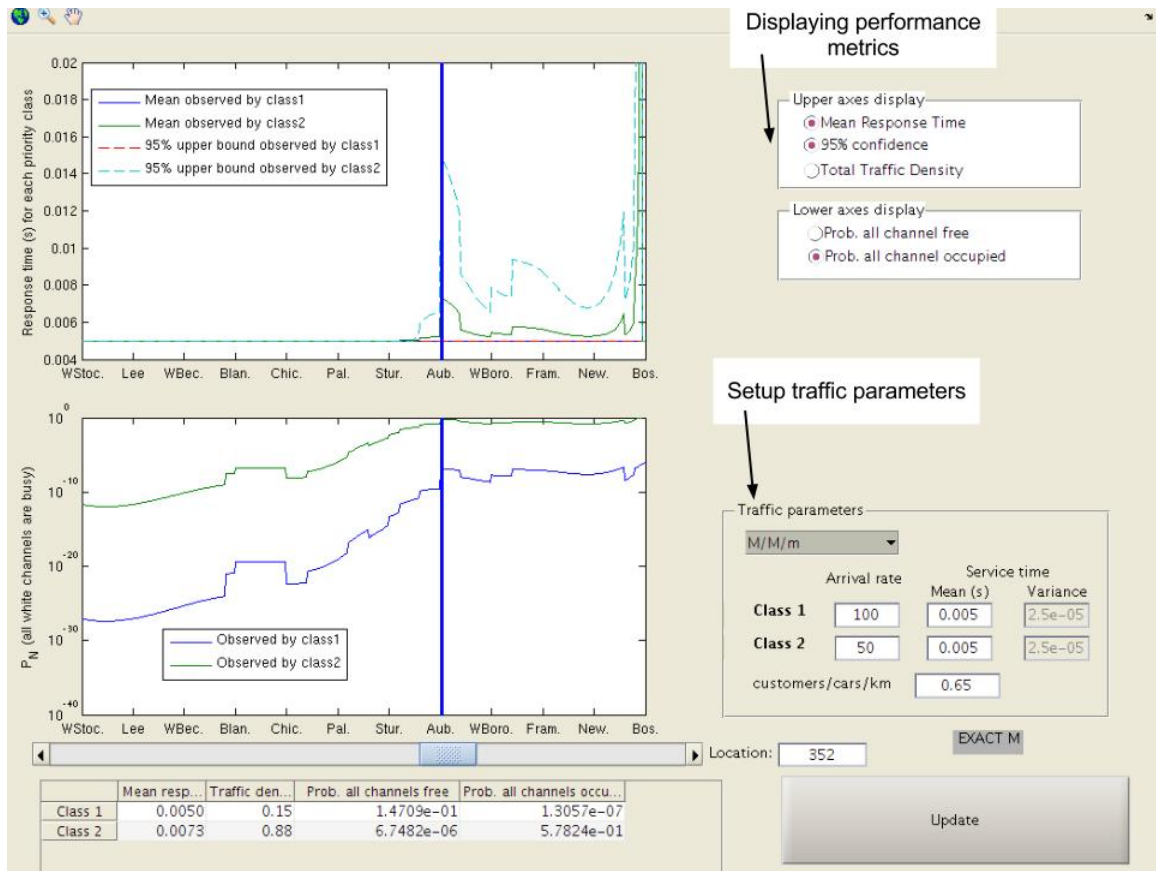

Figure A.2: Queueing analysis tool based on MATLAB GUI for capacity of using TVWS for vehicle communications

Appendix B

VDSA Simulator Based on OMNeT++

The evaluation of VDSA, especially the coexistence with other wireless networks in multiple frequency band in high mobility scenario, is difficult to realize in hardware test. Therefore, we resort to software simulation. In order to emulate DSA in a realistic wireless environment with heterogeneous wireless networks, a simulator may need to consider interference among non-compatible wireless standards. The simulator suit is depicted in Figure B.1.

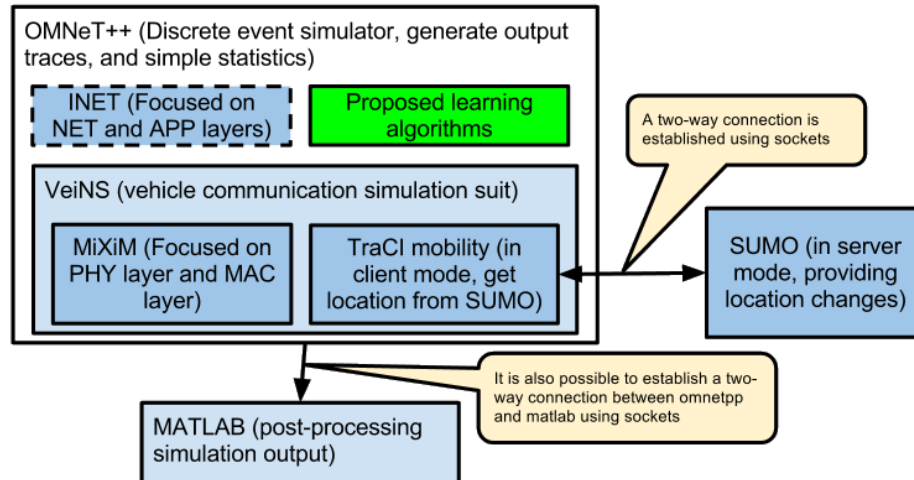

Figure B.1: Experiment setup of the VDSA simulator.

The simulator is based on OMNeT++ and MiXiM framework [138] and coupled with

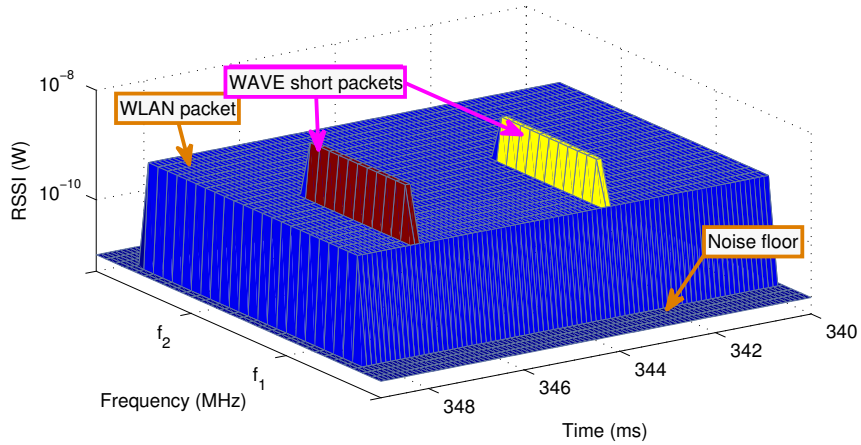

Figure B.2: RSSI in both time and frequency domains.

a road traffic simulator [4]. We expanded the RSSI calculation in MiXiM to incorporate interference between overlapping channels. The RSSI calculation was verified that only packets overlapping in both time and frequency domain would interfere with each other, and non-overlapping packets would not affect the RSSI calculation.

In Figure B.2, we show an example showing the ability of calculating RSSI in both time and frequency domain. This enables our simulator to model the interference between packets when they are partially overlapping in frequency.

In order to simulate a multi-mode vehicle capable of transmission in multiple bands, a car module is created as shown in Figure B.3, where two radios are equipped on the car, each for a different band.

Figure B.4 shows a screenshot of a simulation of cars traveling on a highway through the coverage of several WLANs. Some cars are equipped with wireless communication devices and can connect to WLANs or other cars.

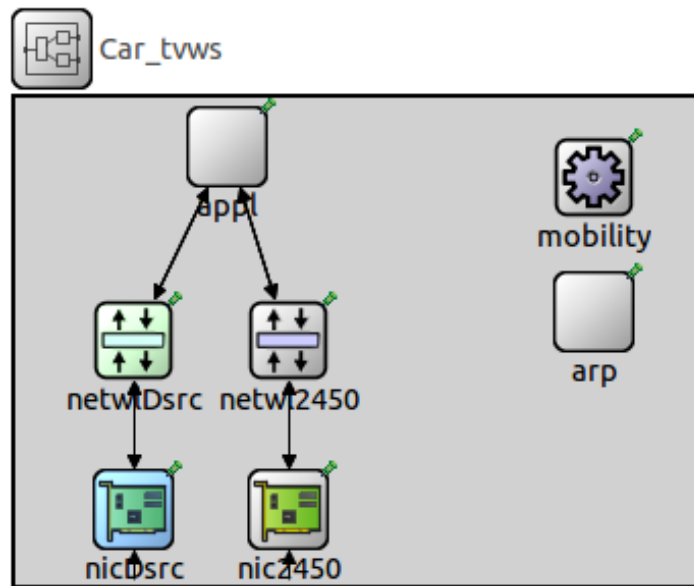

Figure B.3: NED model of a multi-mode car used in the simulator

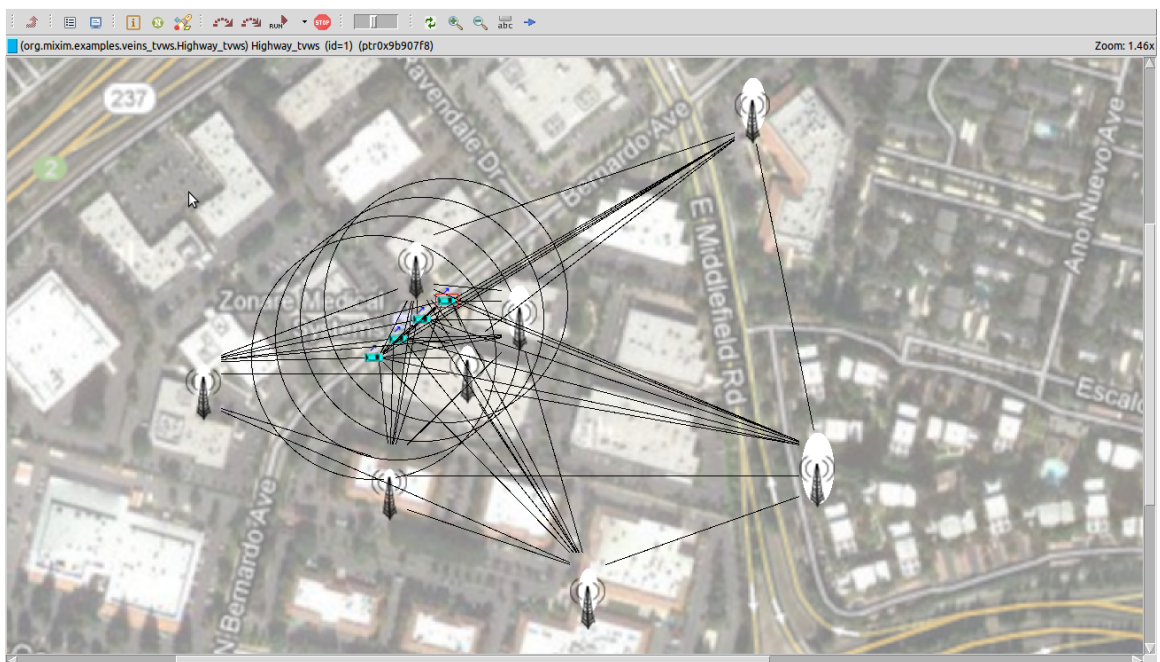

Figure B.4: A VDSA simulator based on OMNeT++.

Bibliography

- [1] E. Guizzo, “How Google’s Self-Driving Car Works,” <http://spectrum.ieee.org/automaton/robotics/artificial-intelligence/how-google-self-driving-car-works>, 2001.
- [2] “Partners for advanced transportation technology,” <http://www.path.berkeley.edu/>.
- [3] “Television Frequencies, CATV Frequencies, & more,” <http://www.tvtower.com/Commercial%20Television%20Frequencies.html>.
- [4] C. Sommer, R. German, and F. Dressler, “Bidirectionally coupled network and road traffic simulation for improved ivc analysis,” *IEEE Transactions on Mobile Computing*, vol. 10, no. 1, pp. 3–15, jan. 2011.
- [5] S. Pagadarai, A. Wyglinski, and R. Vuyyuru, “Characterization of vacant UHF TV channels for vehicular dynamic spectrum access,” in *IEEE Vehicular Networking Conference (VNC)*, 2009, pp. 1–8.
- [6] I. Watson and F. Marir, “Case-based reasoning: a review,” *Knowledge Engineering Review*, vol. 9, no. 4, pp. 327–354, 1994.
- [7] S. Chen, C. Ghosh, A. Wyglinski, and S. Jayaweera, “Impact of group cooperation over competitive secondary subnetworks,” in *2011 IEEE Pacific Rim Conference on Communications, Computers and Signal Processing (PacRim)*. IEEE, 2011, pp. 768–773.
- [8] “Google driverless car,” http://en.wikipedia.org/wiki/Google_driverless_car.
- [9] FCC, “Spectrum policy task force report, ET Docket No. 02-155,” Nov 2002.
- [10] —, “Facilitating Opportunities for Flexible, Efficient, and Reliable Spectrum Use Employing Cognitive Radio Technologies, Docket No 03-322 Notice of proposed rule making and order,” 2003.

- [11] J. Mitola III, "Cognitive radio architecture," *Cognitive Networks*, pp. 147–202, 1998.
- [12] R. Sagers, W. Werner, S. Hall, and D. Heinzlmann, "Location-based adaptive radio control," Aug 1995, US Patent 5,442,805.
- [13] W. Vereecken, W. Van Heddeghem, D. Colle, M. Pickavet, and P. Demeester, "Overall ict footprint and green communication technologies," in *4th International Symposium on Communications, Control and Signal Processing (ISCCSP)*. IEEE, 2010, pp. 1–6.
- [14] A. Schwarzenegger, E. Rendell, and M. Bloomberg, "Special Report: The Infrastructure Roundtables: Concluding ThoughtsIts Time to Get Serious about Investing in Our Infrastructure," *Civil Engineering-ASCE*, vol. 80, no. 4, pp. 102–103, 2010.
- [15] M. Regan, J. Oxley, S. Godley, and C. Tingvall, *Intelligent transport systems: Safety and human factors issues*, 2001, no. 01/01.
- [16] C. Cseh, "Architecture of the dedicated short-range communications (dsrc) protocol," in *48th IEEE Vehicular Technology Conference (VTC)*, vol. 3. IEEE, 1998, pp. 2095–2099.
- [17] Federal Communications Commission, "FCC 99-305. FCC Report and Order," Institution, Tech. Rep., October 1999.
- [18] D. Jiang and L. Delgrossi, "Ieee 802.11 p: Towards an international standard for wireless access in vehicular environments," in *IEEE Vehicular Technology Conference, VTC Spring*. Ieee, 2008, pp. 2036–2040.
- [19] S. Chen, A. M. Wyglinski, R. Vuyyuru, and O. Altintas, "Feasibility analysis of vehicular dynamic spectrum access via queueing theory model," in *IEEE Vehicular Networking Conference (VNC)*, Dec. 2010.
- [20] S. Chen, S. Pagadarai, R. Vuyyuru, A. M. Wyglinski, and O. Altintas, "Feasibility analysis of vehicular dynamic spectrum access via queueing theory model," *IEEE Communications Magazine*, Nov. 2011.
- [21] S. Chen, R. Vuyyuru, A. M. Wyglinski, and O. Altintas, "On Optimizing Vehicular Dynamic Spectrum Access Networks: Automation and Learning in Mobile Wireless Environments," in *IEEE Vehicular Networking Conference (VNC)*, 2011.

- [22] S. Chen, R. Vuyyuru, O. Altintas, and A. M. Wyglinski, "Learning in vehicular dynamic spectrum access networks: Opportunities and challenges," in *Proceedings of the International Symposium on Intelligent Signal Processing and Communication Systems*, Chiang Mai, Thailand, Dec. 2011.
- [23] —, "Learning-based channel selection of vdsa networks in shared tv whitespace," in *IEEE Vehicular Technology Conference (VTC2012-Fall)*. IEEE, 2012, pp. 1–3.
- [24] S. Chen and A. M. Wyglinski, "Efficient spectrum utilization via cross-layer optimization in distributed cognitive radio networks," *Elsevier Computer Commun.*, 2008.
- [25] S. Rocke, S. Chen, R. Vuyyuru, O. Altintas, and A. M. Wyglinski, "Knowledge-based dynamic channel selection in vehicular networks," in *IEEE Vehicular Networking Conference (VNC)*, 2012.
- [26] S. Chen, T. Newman, J. Evans, and A. Wyglinski, "Genetic algorithm-based optimization for cognitive radio networks," in *IEEE Sarnoff Symposium*. IEEE, 2010, pp. 1–6.
- [27] S. Chen and A. Wyglinski, "Cognitive radio-enabled distributed cross-layer optimization via genetic algorithms," in *Cognitive Radio Oriented Wireless Networks and Communications, 2009. CROWNCOM'09. 4th International Conference on*. IEEE, 2009, pp. 1–6.
- [28] C. Ghosh, S. Chen, D. Agrawal, and A. Wyglinski, "Priority-based spectrum allocation for cognitive radio networks employing nc-ofdm transmission," in *Military Communications Conference, 2009. MILCOM 2009. IEEE*. IEEE, 2009, pp. 1–5.
- [29] S. Chen and A. M. Wyglinski, "Distributed optimization of cognitive radios employed in dynamic spectrum access networks," in *Fifth Annual IEEE Communications Society Conference on Sensor, Mesh and Ad Hoc Communications and Networks – SECON 2008*, 2008.
- [30] <http://news.xgo.com.cn/7/73003.html>.
- [31] "Integrated vehicle-based safety system," <http://www.its.dot.gov/ivbss/>.
- [32] "Entune - toyota," <http://www.toyota.com/entune/>.
- [33] <http://www.car-to-car.org/>.

- [34] Ministry of Internal Affairs and Communications of Japan, http://www.soumu.go.jp/menu_news/s-news/2007/070627_4.html, June 2007, (in Japanese).
- [35] R. Sevljan, C. Chun, I. Tan, A. Bahai, and K. Laberteaux, “Channel characterization for 700 MHz DSRC vehicular communication,” *Journal of Electrical and Computer Engineering*, vol. 2010, p. 40, 2010.
- [36] “Safe road trains for the environment (sartre),” <http://www.sartre-project.eu/>.
- [37] Waze, “Waze, a community-based traffic & navigation app,” www.waze.com.
- [38] H. Hartenstein and K. Laberteaux, “A tutorial survey on vehicular ad hoc networks,” *IEEE Communications Magazine*, vol. 46, no. 6, pp. 164–171, 2008.
- [39] O. Altintas, M. Nishibori, T. Oshida, Y. Ihara, and M. Saito, “Demonstration of Vehicle to Vehicle Communications over TV White Space (Demo paper),” in *4th International Symposium on Wireless Vehicular Communications (WIVEC)*, 2011.
- [40] T. Rzayev, Y. Shi, A. Vafeiadis, S. Pagadarai, and A. M. Wyglinski, “Implementation of a vehicular networking architecture supporting dynamic spectrum access,” in *Proceedings of the IEEE Vehicular Network Conference*, Amsterdam, The Netherlands, Nov. 2011.
- [41] SUMO, “Simulation of urban mobility,” <http://sumo.sourceforge.net/>.
- [42] OMNeT++, “An extensible, modular, component-based c++ simulation library and framework, primarily for building network simulators,” <http://omnetpp.org/>.
- [43] FCC Spectrum Policy Task Force, “Report of the spectrum efficiency working group,” <http://transition.fcc.gov/sptf/reports.html>, Nov 2002.
- [44] “Spectrum reports,” <http://www.sharedspectrum.com/papers/spectrum-reports/>, Shared Spectrum Company, Tech. Rep.
- [45] M. Islam, C. Koh, S. Oh, X. Qing, Y. Lai, C. Wang, Y.-C. Liang, B. Toh, F. Chin, G. Tan, and W. Toh, “Spectrum survey in singapore: Occupancy measurements and analyses,” in *3rd International Conference on Cognitive Radio Oriented Wireless Networks and Communications (CrownCom)*, May 2008, pp. 1–7.

- [46] D. Čabrić, S. Mishra, D. Willkomm, R. Brodersen, and A. Wolisz, “A cognitive radio approach for usage of virtual unlicensed spectrum,” in *14th IST Mobile and Wireless Communications Summit*, no. June, 2005.
- [47] S. Pagadarai and A. Wyglinski, “A quantitative assessment of wireless spectrum measurements for dynamic spectrum access,” in *4th International Conference on Cognitive Radio Oriented Wireless Networks and Communications (CROWNCOM)*, Jun. 2009.
- [48] FCC, “TVQ TV Database Query,” <http://transition.fcc.gov/mb/video/tvq.html>.
- [49] —, “In the matter of unlicensed operation in the tv broadcast bands additional spectrum for unlicensed devices below 900 mhz and in the 3 ghz band , docket no 04-113 notice of proposed rule making and order,” 2004.
- [50] S. Pagadarai and A. M. Wyglinski, “Wireless spectrum characterization and dynamic utilization in vehicular communication networks,” Worcester Polytechnic Institute, Tech. Rep., 2009.
- [51] Federal Communications Commission, “FCC Rules, Part-15 Radio frequency devices, Subpart H Television Band Devices.”
- [52] K. Harrison, S. Mishra, and A. Sahai, “How much white-space capacity is there?” in *4th IEEE International Symposium on New Frontiers in Dynamic Spectrum Access Networks (DySPAN)*, 2010.
- [53] W. Lemstra, V. Hayes, and J. Groenewegen, *The innovation journey of Wi-Fi: the road to global success*. Cambridge Univ Pr, 2010.
- [54] S. Geirhofer, L. Tong, and B. Sadler, “A measurement-based model for dynamic spectrum access in wlan channels,” in *IEEE Military Communications Conference*. IEEE, 2006.
- [55] R. Raghavendra, J. Padhye, R. Mahajan, and E. Belding, “Wi-Fi Networks are Underutilized,” Microsoft Research, Tech. Rep., 2009.
- [56] T. Rondeau and C. Bostian, *Artificial intelligence in wireless communications*. Artech House Publishers, 2009.
- [57] I. F. Akyildiz, W.-Y. Lee, M. C. Vuran, and S. Mohanty, “Next generation/dynamic spectrum access/cognitive radio wireless networks: A survey,” *Computer Networks*, 2006.

- [58] J. Mitola III and G. Maguire Jr, "Cognitive radio: making software radios more personal," *IEEE Personal Communications*, vol. 6, no. 4, pp. 13–18, 1999.
- [59] FCC, "The office of engineering and technology hosting workshop on cognitive radio technologies may 19, 2003 et docket no. 03-108," News Release at 1 (rel. May 16, 2003) (Cognitive Radio Workshop News Release).
- [60] "Cognitive radio," http://en.wikipedia.org/wiki/Cognitive_radio, [Accessed Apr. 26, 2011].
- [61] "Cognitive radio," http://en.wikipedia.org/wiki/Cognitive_radio, [Accessed May. 7, 2012].
- [62] S. Haykin, "Cognitive radio: brain-empowered wireless communications," *IEEE Journal on Selected Areas in Communications*, 2005.
- [63] SDR Forum Cognitive Radio Working Group and others, "Cognitive radio definitions and nomenclature (SDRF-06-P-0009-V1.0.0)," September 2008.
- [64] International Telecommunication Union, "Report ITU-R SM.2152 Definitions of Software Defined Radio (SDR) and Cognitive Radio System (CRS)," 2009.
- [65] S. Jayaweera and T. Li, "Dynamic spectrum leasing in cognitive radio networks via primary-secondary user power control games," *IEEE Transactions on Wireless Communications*, vol. 8, no. 6, 2009.
- [66] J. McCarthy, "What is artificial intelligence?" <http://www-formal.stanford.edu/jmc/whatisai.html>, 2007.
- [67] K. Kim, I. Akbar, K. Bae, J. Urn, C. Spooner, and J. Reed, "Cyclostationary approaches to signal detection and classification in cognitive radio," in *2nd IEEE International Symposium on New Frontiers in Dynamic Spectrum Access Networks (DySPAN)*, 2007, pp. 212–215.
- [68] T. Rondeau, B. Le, C. Rieser, and C. Bostian, "Cognitive radios with genetic algorithms: Intelligent control of software defined radios," in *Software Defined Radio Forum Technical Conference*, 2004.
- [69] C. Clancy, J. Hecker, E. Stuntebeck, and T. O'Shea, "Applications of machine learning to cognitive radio networks," *IEEE Wireless Communications*, vol. 14, no. 4, pp. 47–52, 2007.

- [70] A. He, K. Bae, T. Newman, J. Gaeddert, K. Kim, R. Menon, L. Morales-Tirado, J. Neel, Y. Zhao, J. Reed *et al.*, “A survey of artificial intelligence for cognitive radios,” *IEEE Transactions on Vehicular Technology*, vol. 59, no. 4, pp. 1578–1592, 2010.
- [71] J. Palicot and C. Roland, “A new concept for wireless reconfigurable receivers,” *Communications Magazine, IEEE*, vol. 41, no. 7, pp. 124 – 132, july 2003.
- [72] R. Sutton and A. Barto, *Reinforcement learning: An introduction*. Cambridge Univ Press, 1998, vol. 116.
- [73] J. Vincent J. Kovarik, *Cognitive radio technology*. Academic Press, 2008, ch. Cognitive research: Knowledge representation and learning.
- [74] “Cyber Rodent Project,” <http://www.cns.atr.jp/cnb/crp/>.
- [75] K. S. Narendra and M. A. L. Thathachar, *Learning automata: an introduction*. Upper Saddle River, NJ, USA: Prentice-Hall, Inc., 1989.
- [76] Y. Song, Y. Fang, and Y. Zhang, “Stochastic channel selection in cognitive radio networks,” in *IEEE Global Telecommunications Conference (GLOBECOM)*, nov. 2007, pp. 4878 –4882.
- [77] S. Kiran and R. Chandramouli, “An adaptive energy-efficient link layer protocol using stochastic learning control,” in *IEEE International Conference on Communications (ICC)*, vol. 2. IEEE, 2003, pp. 1114–1118.
- [78] H. Liu, K. Liu, and Q. Zhao, “Logarithmic weak regret of non-bayesian restless multi-armed bandit,” in *2011 IEEE International Conference on Acoustics, Speech and Signal Processing (ICASSP)*. IEEE, 2011, pp. 1968–1971.
- [79] D. E. Goldberg, *Genetic Algorithms in Search, Optimization and Machine Learning*. New York, NY, USA: Addison-Wesley Longman Publishing Co., Inc., 1989.
- [80] S. Kirkpatrick, C. Gelatt, and M. Vecchi, “Optimization by simulated annealing,” *Science*, vol. 220, no. 4598, p. 671, 1983.
- [81] Y. Zhao, J. Gaeddert, K. Bae, and J. Reed, “Radio environment map enabled situation-aware cognitive radio learning algorithms,” in *Software Defined Radio Forum (SDRF) technical conference*, 2006.

- [82] X. Wang, A. Wong, and P. Ho, “Extended knowledge-based reasoning approach to spectrum sensing for cognitive radio,” *IEEE Transactions on Mobile Computing*, vol. 9, no. 4, pp. 465–478, 2010.
- [83] IEEE WG802.22, “IEEE 802.22-2011(TM) Standard for Cognitive Wireless Regional Area Networks (RAN) for Operation in TV Bands,” 2011.
- [84] Y. Shoham, R. Powers, and T. Grenager, “Multi-agent reinforcement learning: a critical survey,” 2003, unpublished survey. <http://robotics.stanford.edu/shoham>.
- [85] L. Busoniu, R. Babuska, and B. De Schutter, “Multi-agent reinforcement learning: A survey,” in *9th International Conference on Control, Automation, Robotics and Vision, ICARCV’06.*, 2006, pp. 1–6.
- [86] A. Sendonaris, E. Erkip, and B. Aazhang, “User cooperation diversity. part i. system description,” *IEEE Transactions on Communications*, vol. 51, no. 11, pp. 1927 – 1938, 2003.
- [87] ———, “User cooperation diversity. part ii. implementation aspects and performance analysis,” *IEEE Transactions on Communications*, vol. 51, no. 11, pp. 1939 – 1948, 2003.
- [88] J. Laneman and G. Wornell, “Distributed space-time-coded protocols for exploiting cooperative diversity in wireless networks,” *IEEE Transactions on Information theory*, vol. 49, no. 10, pp. 2415–2425, 2003.
- [89] P. Liu, Z. Tao, S. Narayanan, T. Korakis, and S. S. Panwar, “CoopMAC: A Cooperative MAC for Wireless LANs,” *IEEE Journal on Selected Areas in Communications*, vol. 25, no. 2, pp. 340 –354, 2007.
- [90] C. Saraydar, N. Mandayam, and D. Goodman, “Efficient power control via pricing in wireless data networks,” *IEEE Transactions on Communications*, vol. 50, no. 2, pp. 291 –303, Feb. 2002.
- [91] Z. Han, “Degrees of Cooperation in Dynamic Spectrum Access for Distributed Cognitive Radios,” *Cognitive Wireless Communication Networks*, pp. 231–270, 2007.
- [92] K. Ben Letaief and W. Zhang, “Cooperative communications for cognitive radio networks,” *Proceedings of the IEEE*, vol. 97, no. 5, pp. 878 –893, May 2009.

- [93] Z. Han and H. Poor, "Coalition games with cooperative transmission: a cure for the curse of boundary nodes in selfish packet-forwarding wireless networks," *IEEE Transactions on Communications*, vol. 57, no. 1, pp. 203–213, 2009.
- [94] D. Niyato and E. Hossain, "Competitive pricing for spectrum sharing in cognitive radio networks: Dynamic game, inefficiency of nash equilibrium, and collusion," *IEEE Journal on Selected Areas in Communications*, vol. 26, no. 1, pp. 192–202, jan. 2008.
- [95] D. Niyato, E. Hossain, and Z. Han, "Dynamics of Multiple-Seller and Multiple-Buyer Spectrum Trading in Cognitive Radio Networks: A Game-Theoretic Modeling Approach," *IEEE Transactions on Mobile Computing*, pp. 1009–1022, 2008.
- [96] P. Liu, Z. Tao, Z. Lin, E. Erkip, and S. Panwar, "Cooperative wireless communications: A cross-layer approach," *IEEE Wireless Communications*, vol. 13, no. 4, pp. 84–92, 2006.
- [97] H. Shan, W. Zhuang, and Z. Wang, "Distributed cooperative MAC for multihop wireless networks," *IEEE Communications Magazine*, vol. 47, no. 2, pp. 126–133, 2009.
- [98] A. Nosratinia, T. Hunter, and A. Hedayat, "Cooperative communication in wireless networks," *Communications Magazine, IEEE*, vol. 42, no. 10, pp. 74–80, 2004.
- [99] S. K. Jayaweera, "Virtual MIMO-based cooperative communication for energy-constrained wireless sensor networks," *IEEE Transactions on Wireless Communications*, vol. 5, no. 5, pp. 984–989, 2006.
- [100] L. Kleinrock, *Queueing Systems: Volume 2: Computer Applications*. John Wiley & Sons New York, 1976.
- [101] M. Karol, Z. Liu, and K. Eng, "Distributed-queueing request update multiple access (DQRUMA) for wireless packet (ATM) networks," in *IEEE International Conference on Communications (ICC)*, vol. 2, 1995.
- [102] G. Li and H. Liu, "Dynamic resource allocation with finite buffer constraint in broadband OFDMA networks," *IEEE Wireless Comm. and Networking*, vol. 2, pp. 1037–1042, 2003.

- [103] G. Song, Y. Li, and M. Inc, "Utility-based resource allocation and scheduling in OFDM-based wireless broadband networks," *IEEE Communications Magazine*, vol. 43, no. 12, pp. 127–134, 2005.
- [104] H. Li, "Socially optimal queuing control in cognitive radio systems: Pricing and learning," in *IEEE Wireless Communications and Networking Conference (WCNC)*, 2010.
- [105] F. Borgonovo, M. Cesana, and L. Fratta, "Throughput and Delay Bounds for Cognitive Transmissions," *International Federation for Information Processing Digital Library*, vol. 265, no. 1, 2008.
- [106] H. Shiang and M. van der Schaar, "Queuing-based dynamic channel selection for heterogeneous multimedia applications over cognitive radio networks," *IEEE Transactions on Multimedia*, vol. 10, no. 5, pp. 896–909, 2008.
- [107] H. Shiang, W. Tu, and M. Schaar, "Predictive Spectrum Access for Multimedia Users over Multi-Channel Wireless Networks," *Journal of Communications*, vol. 4, no. 9, p. 640, 2009.
- [108] O. Simeone, Y. Bar-Ness, and U. Spagnolini, "Stable throughput of cognitive radios with and without relaying capability," *IEEE Transactions on Communications*, vol. 55, no. 12, p. 2351, 2007.
- [109] S. Tang and B. Mark, "Analysis of opportunistic spectrum sharing with Markovian arrivals and phase-type service," *IEEE Transactions on Wireless Communications*, vol. 8, no. 6, 2009.
- [110] D. Fiems, T. Maertens, and H. Bruneel, "Queueing systems with different types of server interruptions," *European Journal of Operational Research*, vol. 188, no. 3, pp. 838–845, 2008.
- [111] W. Gray, P. Wang, and M. Scott, "A vacation queueing model with service breakdowns," *Applied Mathematical Modelling*, vol. 24, no. 5-6, pp. 391–400, 2000.
- [112] B. Doshi, "Queueing systems with vacations: A survey," *Queueing systems*, vol. 1, no. 1, pp. 29–66, 1986.
- [113] J. McGill, "Optimal control of queueing systems with variable number of exponential servers," Tech. Rep., 1969.

- [114] J. Moder and C. Phillips Jr, “Queuing with fixed and variable channels,” *Operations Research*, pp. 218–231, 1962.
- [115] I. Mitran and B. Avi-Itzhak, “A many-server queue with service interruptions,” *Operations Research*, vol. 16, no. 3, pp. 628–638, 1968.
- [116] S. Keshavamurthy and K. Chandra, “Multiplexing Analysis for Dynamic Spectrum Access,” in *Military Communications Conference (MILCOM)*, 2006, pp. 1–7.
- [117] C. Zhang, X. Wang, and J. Li, “Cooperative Cognitive Radio with Priority Queueing Analysis,” *IEEE International Conference on Communications (ICC)*, 2009.
- [118] S. Shankar, “Squeezing the Most Out of Cognitive Radio: A Joint MAC/PHY Perspective,” in *IEEE International Conference on Acoustics, Speech and Signal Processing (ICASSP)*, vol. 4, Apr. 2007.
- [119] S. Nozaki and S. Ross, “Approximations in finite-capacity multi-server queues with Poisson arrivals,” *Journal of Applied Probability*, vol. 15, no. 4, pp. 826–834, 1978.
- [120] A. Bondi and J. Buzen, “The response times of priority classes under preemptive resume in M/G/m queues,” in *ACM SIGMETRICS conference on Measurement and modeling of computer systems*. ACM, 1984, p. 201.
- [121] N. Jain, S. Das, and A. Nasipuri, “A multichannel csma mac protocol with receiver-based channel selection for multihop wireless networks,” in *Tenth International Conference on Computer Communications and Networks*, 2001, pp. 432–439.
- [122] S. Huang, X. Liu, and Z. Ding, “Opportunistic spectrum access in cognitive radio networks,” in *The 27th IEEE Conference on Computer Communications (INFOCOM)*. Ieee, 2008, pp. 1427–1435.
- [123] A. Min, K.-H. Kim, J. Singh, and K. Shin, “Opportunistic spectrum access for mobile cognitive radios,” in *IEEE Conference on Computer Communications (INFOCOM)*, april 2011, pp. 2993–3001.
- [124] W. Lee and I. Akyildiz, “Optimal spectrum sensing framework for cognitive radio networks,” *IEEE Transactions on Wireless Communications*, vol. 7, no. 10, pp. 3845–3857, 2008.
- [125] P. Auer, N. Cesa-Bianchi, and P. Fischer, “Finite-time analysis of the multiarmed bandit problem,” *Machine learning*, vol. 47, no. 2, pp. 235–256, 2002.

- [126] FCC, “In the Matter of Facilitating the Provision of Spectrum-Based Services to Rural Areas and Promoting Opportunities for Rural Telephone Companies To Provide Spectrum-Based Services,” 2003.
- [127] T. ElBatt and A. Ephremides, “Joint scheduling and power control for wireless ad hoc networks,” *IEEE Transactions on Wireless communications*, vol. 3, no. 1, pp. 74–85, 2004.
- [128] A. Bletsas, H. Shin, and M. Win, “Cooperative communications with outage-optimal opportunistic relaying,” *IEEE Transactions on Wireless Communications*, vol. 6, no. 9, pp. 3450–3460, 2007.
- [129] J. Laneman, D. Tse, and G. Wornell, “Cooperative diversity in wireless networks: Efficient protocols and outage behavior,” *IEEE Transactions on Information Theory*, vol. 50, no. 12, pp. 3062–3080, 2004.
- [130] O. Altintas, Y. Ihara, H. Kremo, H. Tanaka, M. Ohtake, T. Fujii, C. Yoshimura, K. Ando, K. Tsukamoto, M. Tsuru *et al.*, “Field tests and indoor emulation of distributed autonomous multi-hop vehicle-to-vehicle communications over tv white space,” in *Proceedings of the 18th annual international conference on Mobile computing and networking*. ACM, 2012, pp. 439–442.
- [131] IEEE WG802.11, “IEEE 802.11h(TM) IEEE Standard for Information technologyTelecommunications and information exchange between systemsLocal and metropolitan area networks Specific requirements. Part 11: Wireless LAN Medium Access Control (MAC) and Physical Layer (PHY) specifications. Amendment 5: Spectrum and Transmit Power Management Extensions in the 5 GHz band in Europe,” 2003.
- [132] G. Corporation, “Gateworks cambria network processor gw2358-4,” <http://shop.gateworks.com/index.php?act=viewProd&productId=53>.
- [133] G. Wu and T. Chiueh, “Passive and Accurate Traffic Load Estimation for Infrastructure-Mode Wireless LAN,” in *Proceedings of the 10th ACM Symposium on Modeling, analysis, and simulation of wireless and mobile systems*. ACM, 2007, pp. 109–116.
- [134] Debugfs, <http://en.wikipedia.org/wiki/Debugfs>.

- [135] V. Navda, A. Bohra, S. Ganguly, and D. Rubenstein, “Using channel hopping to increase 802.11 resilience to jamming attacks,” in *26th IEEE International Conference on Computer Communications. IEEE INFOCOM*. IEEE, 2007, pp. 2526–2530.
- [136] J. Kenney, “Dedicated short-range communications (dsrc) standards in the united states,” *Proceedings of the IEEE*, vol. 99, no. 7, pp. 1162–1182, july 2011.
- [137] G. Wu, S. Singh, and T. Chiueh, “Implementation of dynamic channel switching on ieee 802.11-based wireless mesh networks,” in *Proceedings of the 4th Annual International Conference on Wireless Internet*. ICST (Institute for Computer Sciences, Social-Informatics and Telecommunications Engineering), 2008, p. 39.
- [138] A. Köpke, M. Swigulski, K. Wessel, D. Willkomm, P. T. K. Haneveld, T. E. V. Parker, O. W. Visser, H. S. Lichte, and S. Valentin, “Simulating wireless and mobile networks in omnet++ the mixim vision,” in *Proceedings of the 1st international conference on Simulation tools and techniques for communications, networks and systems & workshops*, ser. Simutools '08, 2008, pp. 71:1–71:8.