

Project Number: JR1 9999

*Mote: A Musical Adventure Game*  
A Major Qualifying Project Report:  
submitted to the Faculty  
of the  
WORCESTER POLYTECHNIC INSTITUTE  
in partial fulfillment of the requirements for the  
Degree of Bachelor of Science  
by

**Joseph Cotnoir, Daniel Corfman, Graham Pentheny, Steven Foley, and Kevin Nolan**

Date: April 29, 2010

Approved:

**Professor Joshua Rosenstock, Project Advisor**

**Professor Mark Claypool, Project Co-Advisor**

## Table of Contents

Abstract:.....	5
1 Introduction .....	6
1.1 Team Roles.....	7
2 Conceptual Designs.....	9
2.1 Improvisational Music Game .....	9
2.2 Existing Games in the Genre .....	10
2.3 Game Conceptualization.....	11
2.4 Concept Art.....	14
3. Technical Design.....	21
3.1 Motivation and Purpose.....	22
3.2 Existing Engines and Their Flaws.....	23
3.3 iPhone-specific Challenges.....	24
3.4 Graphics Engine .....	24
3.4.1 Design .....	25
3.4.2 Implementation .....	31
3.4.3 Initial Results.....	34
3.4.4 Optimizations and Tweaking.....	34
3.4.5 Conclusions .....	42

3.5	Level Editor .....	46
3.6	Lua .....	48
3.6.1	Scripting .....	49
3.6.2	Lua Conclusions.....	52
3.7	State Machine .....	52
3.8	Menu System .....	53
3.10	Sound Engine .....	66
3.11	Particle System .....	68
4	Artistic Designs .....	71
4.1	Character Design.....	72
4.1.1	Characters.....	73
4.2	World Tiles .....	76
4.3	Interface Considerations.....	79
4.4	Music Design.....	84
4.5	Sound Effects .....	86
4.5.1	Voices.....	86
4.5.2	Environment Sounds.....	87
4.6	Dialogue.....	88
4.7	Level Design .....	89

5 Postmortem .....	92
5.1 Concept Design .....	92
5.2 Scope and Team Composition.....	92
5.3 Write From The Beginning .....	93
5.4 Layers and Tiles .....	93
6 Conclusion.....	95
Appendix B: Technical Design Document .....	109
Appendix C: Summary of Research into Similar Games .....	122
Appendix D: Mary Yovina's Animations .....	125



## **Abstract:**

The *Mote* development team consisted of five individuals--three programmers and two artists--and intended to make a video game for the iPhone that could be a casual game involving the improvisation of music. The team designed and created two levels of an adventure game called *Mote*, in which a player explores a dream world as an anthropomorphic whole note named Mote. Mote plays music for other characters and influences their emotions to solve in-game problems. Both levels featured full voice acting, music, custom animations, and original scenery, as well as a custom scripting engine, custom physics and graphics engines, a custom sound engine, and a complete level editor. While the achievements were incredible, testing showed that the game-play mechanics could be expanded.

## 1 Introduction

Through a series of impressive milestones of programming and artistic expression, *Mote* bounded onto the iPhone platform, giving players access to a completely hand-made musical adventure. The game engine, built from scratch, was an incredible achievement for the programmers involved. And while the casual gamer may not notice the complete engine, they could easily notice the artistic design for both visual and audio.

*Mote's* dream-world draws a player into a universe where music solves problems by changing listeners' moods. The titular character must journey through a scenic forest and an imposing pirate ship in order to discover subconscious memories of music theory knowledge. To do so, he will have to interact with other dream element characters, also called "notes." This is done by playing a simple eight-note riff through a piano-like interface. The eight note riff will summon a song that will then affect the mood of the character that the player is interacting with. This response can cause characters to open doors, smash walls, or otherwise remove an obstacle in *Mote's* way. This simple gameplay targeted *Mote* to the casual player, and made our game feel friendly and entertaining to any player.

*Mote* also demonstrates potential for the future of game design. During the course of the project, robust graphics, sound, and physics systems were devised that

could be used to power future projects. In addition, the level editor and the simple format used to create art assets through Adobe Photoshop can empower future artists to build upon *Mote* or create an equally interesting iPhone game of their own.

## 1.1 Team Roles

The development team for *Mote* originally consisted of two artists and three developers. The art team consisted of Joe Cotnoir and Daniel “DC” Corfman. Joe created the main menu music, concept art, sound effects, and provided some voice acting and recording. Credited voice actors and instrumentalists include Dan Cotnoir, Eugene Sanzi and Benjamin Provost. DC created the environment art, designed puzzles, and helped with the artistic direction. Midway through the development of the game Mary Yovina was added to assist Joe and DC with asset creation. Mary created character animations and contributed to the art direction through her character style.

The technical development team consisted of Steven Foley, Kevin Nolan and Graham Pentheny. All three developers contributed to the game engine design as well as the initial engine features. As the project progressed, Steve specialized in the level editor, level-loading, and collisions code. Kevin focused on audio and game scripting in collaboration with DC. Graham committed to the graphics engine, performing extensive analysis as his Computer Science portion of the project.

The project was completed under the advisement of Professor Joshua Rosenstock of the Interactive Media and Game Development (IMGD) department.

Computer Science professor and IMGD department head Professor Mark Claypool also advised Graham during his graphics optimization work. Special thanks are also given to Professor Brian Moriarty of the IMGD department for his feedback on initial game designs.

## 2 Conceptual Designs

### 2.1 Improvisational Music Game

*Mote* initially started with the three simple words "Improvisational Music Game." Designed from the ground up, the brainstorming began with the understanding that the user would create their own music or play along with the game at some point.

*Mote's* original concept allowed a player to generate their own spontaneous content. The game, when complete, would allow users to create something musical as they progressed. User progress would be measured on complexity and originality of musical elements, or at least creativity would play a role in advancing something within the game. This element of design was modified and applied to the musical system through a menu in which the player interacts with in-game characters with music abilities.

Of course, *Mote* had to contain musical elements. Our idea was to give users some instantaneous control over some instrument that controlled melody, harmony, rhythm, or timbre. In the end, we gave users control of a small melodic line through an instrument that can be played at will, satisfying the musical portion of this game. Music is also used as a reward of sorts--by playing written songs, the iPod would play back a complex, slightly longer version of the song played.

Our personal target was to create a casual game rather than a purely musical toy--a fun application for anyone with a direct goal and set of rules rather than just a content creation system. This would allow us to create a given set of rules and balance them. While simply a challenge element, it would also add replay value. If we had decided to make a toy, *Mote* may have simply ended up as a tiny piano on the iPhone screen. With a game's framework, *Mote* was able to give a purpose to improvisation rather than just handing a player an instrument and wishing them the best of luck.

The iPhone platform gave us the ultimate tool for the casual, portable game. With nothing but a touch screen and a pocket-sized frame, our concepts were focused on the player who doesn't often play games, but would be able to play for approximately ten minutes at a time. With no complicated buttons to explain, we were able to label everything press-able within the game and explain it clearly.

## 2.2 Existing Games in the Genre

When developing the initial *Mote* concepts, it was important for the team to consider existing games that took steps toward creating an improvisational music experience. We didn't want to tread on too-familiar ground with our game, and just as importantly, we needed inspiration.

Between the music games, the iPhone games, and the assorted other video games that we looked at, a few distinct patterns emerged. We immediately noticed elements of smooth, seamless, and almost rhythmic gameplay in the fun games. You

could play one and go from one screen to another with no effort or waiting. Our focus on fun revealed that interaction between two players or a player and a character made for the best experiences. We also applauded games that tied music deeply into their gameplay--whether it be through tapping along with rhythms or simply more energetic music when large foes appear. And in some games, the character design was enough to draw a player to the game by itself--all early concepts of *Mote* involved clear character design from this point on.

Some games contained elements that we found unsatisfactory, as well. Several iPhone games that we looked at feature interfaces where you would block the UI or important gameplay elements with your finger during normal use of the touch screen. Certain games were just toys--musical tools that had no purpose other than to create tunes and save them. We wanted to have victory conditions in *Mote*, and so these concepts were brushed to the side. Other games had issues with such things as uninteresting or downright punishing challenge levels. One game had a tutorial character that would insult you if you weren't playing up to par--this was certainly something we wanted to avoid.

### **2.3 Game Conceptualization**

Our initial goal was to make a 2D game for the iPhone that needed to have something to do with music. Another goal we had was to release and sell what we make on the App Store, Apple's software distribution platform for the iPhone. Our five-person

team of two artists and three programmers also needed to be able to handle the amount of work needed to be done for whatever concept we came up with.

Our development plan was to come up with a concept in A-Term, create a playable level by the end of B-Term, then use C-Term for generating more level, testing, and polish.

The design phase for Mote went less than smoothly. In the beginning, our designs were too complex or completely non-functional. One of our earliest ideas involved a game where you didn't even have to look at the screen and just tapped on the device according to some audio cues, the idea being that it would be a game people could play while walking down the street and not quite paying attention to the game. We quickly decided that the player would be far too busy walking and would be far too disengaged from what was going on in the game and moved on. We would much rather have a game that was both interesting and engaging for the player than one they would be absentmindedly tapping on.

Another scrapped idea involved using elements of music theory to battle enemies in musical combat. The idea of an action game wasn't entirely unwelcome, but the use of music theory as a core game mechanic in the way it was presented was too complex for a casual game.

One of our later ideas, and the one closest to what we ended up with, involved having the player create music according to a given style. The game would grade the player on how well they adhered to that style. This idea, while interesting, would have



been a nightmare to implement on the tech side. The only way this could have been practical would have been to tell the players explicitly what is “good” and “bad”, which is a rather odd thing to do for this concept since it is supposed to take advantage of music being so subjective.

We settled on a casual adventure game. Fun, as defined for our game, comes from the interactions the player has with the characters and environment, the quality of art and the art style, and the solving of puzzles with music to progress through the environment. We decided that we wanted something more accessible to a casual games audience. A goal we had at this point was to release our game on the App Store. Making a casual game was the best bet we had at having a successful game for the casual games market on the App Store.

Our design vision statement became this: “Mote is a musical adventure game in which the player uses music to alter the emotions of game characters and solve puzzles. The player has a selection of musical riffs that he/she has gathered while playing. These riffs are played to other characters in the game to change their emotional state and produce a desirable outcome to a situation.” It would accomplish our goals of designing a lighthearted casual game with a musical element.

Our vision was (and is) solid. "Mote" is based off of Loom (<http://www.mobygames.com/game/loom>); this old Infocom adventure game proved that such a game could succeed. We had our game concept, first level design, and art

asset list for the first level at the beginning of B-Term as well as just enough time and manpower to do so (minus a 2D animator.)

## 2.4 Concept Art

*Mote's* art style is best described as a lush, soft dream, inhabited by simple characters with basic standards. While our world would be more free-form in terms of the world tiles, our Motes had to be simple personifications of stereotypes. Conceptually, this brought forth the perfect image of a colored dreamscape: there's an emphasis on important, yet slightly unusual items, odd but real locations, and floating characters that could change on a whim and not even care.

The concept of a character in *Mote's* world came from the idea that a whole note would be playable as the hero. *Mote* and his friends are round spheres of dream-like energy that are roughly in the shape of whole notes, and through colors, facial expressions, shapes, and accessories, they represent both human and musical stereotypes. Characters, simply entitled "motes," consist almost entirely of their central body cloud and a lighter "halo" cloud surrounding them. To make them appear more ethereal, it was essential to blur *Mote* and keep his non-accessory features soft.

Motes also carry around accessories that help define their personalities. Originally, this was simply little rotating miniature motes that surrounded them.



Fig. 2.1: A very early concept shot of *Mote* by Daniel Corfman.

Here we see an older vision of *Mote* that shows a red version of our main character. In this version, the miniature colored pieces around Mote rotated and summoned attacks along with the beats of background music playing. Their colors defined their personal attacks and personalities. The red one above is using a powerful attack, and the black mote is evil.

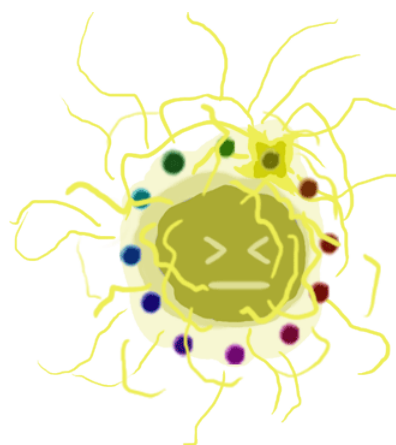

Fig. 2.2: Another very early concept shot of *Mote* by Daniel Corfman with a more aggressive tone.

Here we see Mote charging an electrical attack. Attacking and combat were eliminated from the game as concepts to keep the gameplay light and friendly.

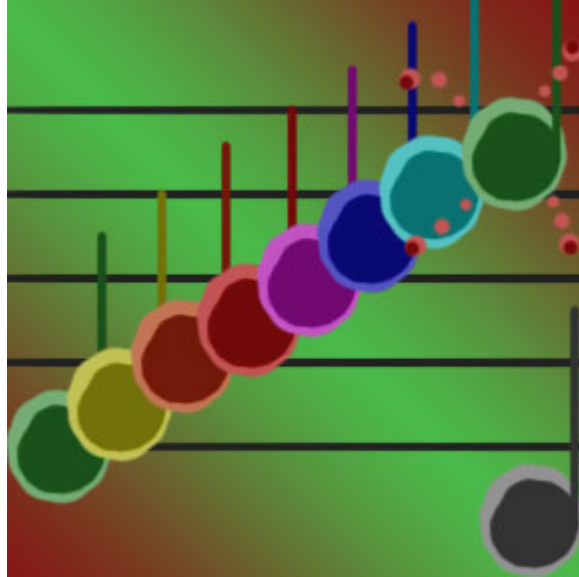

Fig. 2.3: An early idea of an interface, and our color palette of choice.

Early in development, these colors were the only definitions of characters.

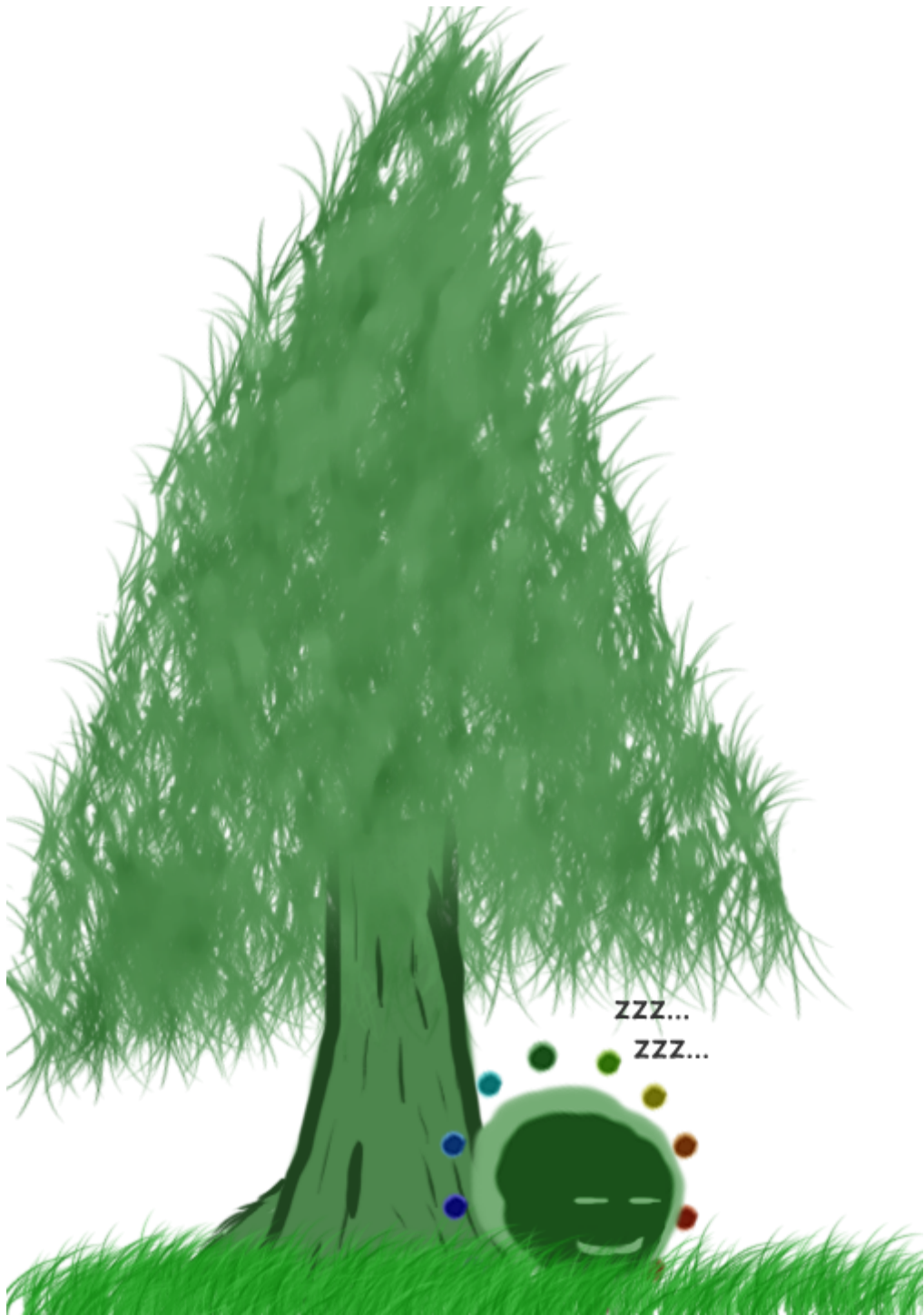

Fig. 2.4: An early idea of an interface, and our color palette of choice.

This piece of art featured Mote happily snoozing below a tree. Charming and simple, it helped to set our visual goals for the project--calm and relaxed.

Colors and orbs were simply not enough to personify our characters, so we resorted to giving our characters accessories to define them more. Accessories were simply articles of real world items that helped show a character's purpose or interests. Hats, hands, and even parrots were used to give Mote's characters life and energy.

While the following concept art didn't quite capture the fuzzy and blurry style achieved earlier, it did keep to the simple "orb with features" that captured the character essence without too much fine detail. It also helped define exactly what each character would be wearing.



Fig. 2.5The MetalHead

Note the helmet, the fiery glow, and the "rock on" pose with his hands and face. Clearly, this fellow represents anger.



Fig. 2.6: "Babby" the Baby

A charming little baby mote that goes by the name "Babby." One of the concepts was that a younger mote had a larger halo and a smaller body, and with time, the halo formed into more of the body. We tried to create the cutest character ever.



Fig. 2.7: The Sleepy Guy

This is a sleeping character whose only purpose is to be woken up in some manner. He is clearly a character based on the need to complete a puzzle.



Fig. 2.8: The Emo Kid

This depressing-looking lad is based on the "emo" fad. He may look depressing compared to the other characters, but in truth, he provides comic relief.



### 3. Technical Design

The iPhone has changed the way people think about mobile gaming. Its impact on the mobile phone gaming market is unprecedented. Tens of millions of iPhones have been sold, and it continues to dominate the smartphone market as the most popular model (<http://techgeist.net/2009/10/iphone-popular-smartphone-world-admob/>).

With Apple's release of the App store and the iPhone software development kit, the iPhone was transformed into a mobile gaming console. Developers had access to a new kind of casual gaming platform. The iPhone offers new user-input schemes through its accelerometers and innovative multi-touch interface. With the addition of OpenGL, the iPhone is an attractive platform for game studios as well as independent developers.

iPhone applications are empowered with new ways of interacting with players. Games are able to interact with the players' photos, music, and address book contents allowing for deep social gaming experiences. The iPhone's GPS allows games to bridge the gap between virtual and reality, integrating elements of Alternate Reality games. Additionally, games can help players interact with other players nearby, contributing to the game's social atmosphere. 3G and Wifi allow for games to draw existing information about the player or other players in the game.

The combination of the iPhone's feature set has led to an explosion in the social gaming market. Games are interacting with their players and the world around them more than ever before. The 180,000 applications of the Apple AppStore (<http://www.macrumors.com/2010/04/08/apples-iphone-os-4-0-media-event-sneak->

[peek-into-the-future/](#)) are a testament to the validity of the iPhone as a viable casual gaming platform.

For the most part, the technical portion of the game was written from scratch; the only third party library used was the LUA interpreter. The graphics engine and audio code were written using only OpenGL and OpenAL respectively. To create and load levels, a custom level editing tool was written in Java. The physics of the game is calculated by checking for collisions between basic geometric shapes.

### **3.1 Motivation and Purpose**

Game engine performance is, like on other platforms, a prime concern when making a game for the iPhone. The iPhone amplifies the necessity for fast and reliable game engine code, and thus the value of preexisting, proven platforms for development. Game engines provide generic functionality that allows developers to focus on creating the essential content of their game, not on utility functionality. Game engines save developers time and money by facilitating fast prototyping of ideas, as well as rapid development of final products. Game engines are also useful for many graphics-intensive applications in fields such as medical imaging and data visualization. By using a game engine framework, scientists and engineers can harness the full power of the iPhone's graphics processor without much prior knowledge of graphics programming.

The motivation for the creation of the graphics engine for Mote was a desire to test the limits of the iPhone's graphics capabilities as well as contribute a unique engine design to the iPhone development community. As this was an academic project, the use of a pre-existing graphics engine was deemed not academically interesting, and thus new solutions were experimented with. We wanted to make a game engine that would allow the user to create exactly the graphical effects they wanted without excess overhead or restrictions. Additionally we wanted to test the capabilities of the iPhone as a gaming platform. We focused on the limits created by the graphics chip, as this became the bottleneck of iPhone game performance.

### 3.2 Existing Engines and Their Flaws

Current iPhone game engines limit the amount of information that can be displayed at once on the screen, and limit the amount of control the user is given. Unity3D (<http://unity3d.com/unity/features/iphone-publishing>), for instance, limits the number of unique pieces of geometry that can be drawn to the screen at once to sixteen as a mechanism for keeping performance consistent. By enforcing this restriction, Unity3D maintains a reasonable frame rate under nearly every circumstance. This restriction, however, does not allow the user to create exactly the graphical functionality that they want, and is therefore not ideal.

Conversely, engines such as Cocos2d (<http://www.cocos2d-iphone.org/>) do not restrict the user to a specific number of elements. Instead Cocos2d provides excessive

functionality that is sometimes never used. This creates unnecessary overhead in the graphics pipeline, and while allowing the user more control over what is rendered to the screen than other engines, will not always render at a high frame rate.

### **3.3 iPhone-specific Challenges**

Game engines must be efficient, especially on mobile platforms such as the iPhone where resources are significantly limited. The iPhone's components were selected by Apple to be very battery efficient, while offering a moderate level of performance. Unfortunately the more powerful the chip, the more power it requires. Because of this the iPhone GPU is quite underpowered. This further emphasizes the benefit of using fast, proven code. With this project we attempted to create a proven platform that developers could rely on for their games and applications. Unlike platforms like gaming consoles or PC's, iPhone game developers need to balance how much battery their game is going to drain with how much performance they require. Using as much CPU, memory and GPU resources as possible at all times will drain the iPhone's battery, creating a poor user experience. Conversely, using too little resources may lead to an uninteresting game.

### **3.4 Graphics Engine**

The iPhone platform offers many new possibilities for user-input and control schemes; however, it also holds many performance limitations. Early in the

development of Mote we realized that the iPhone's graphics chip created a sizeable restriction to the complexity of the scenes in Mote. With this in mind, it was vital to streamline the graphics pipeline as much as possible. In studying the graphics systems of popular iPhone game engines, we determined that they were designed to be used in a wide scope of types of graphics systems, thereby limiting their overall performance. We decided that the most efficient and the most academically challenging approach would be to create a custom graphics engine.

### 3.4.1 Design

The graphics system for Mote was designed to be flexible, simple, and scalable. Mote was designed to have a two-dimensional, three-quarters view graphics style, similar to classic role-playing and adventure games like *The Legend of Zelda: A Link to the Past* (©Nintendo 1992, <http://www.nintendo.co.jp/n02/shvc/zl/index.html>).



Fig. 3.1: Screenshot from *The Legend of Zelda: A Link to the Past* (© Nintendo 1992):

an inspiration for the artistic style of Mote.

This style was accomplished through a combination of artistic style and game engine design. Like a painting, the illusion of perspective and lighting is created through the artistic style of textures, not through transformations of three-dimensional vertex data. Layering of multiple textures also adds to the illusion of depth. Having computationally difficult tasks such as lighting done through the art style helped simplify the graphics engine, and consequentially maximize performance.



Fig. 3.2: Mote's graphics were broken down into unique uniformly-sized tiles.

The game's graphics are based on an orthographic view of a mosaic of textured, square quads. Each square, or "tile," is aligned to one of three parallel planes called "render layers." Each render layer constitutes one of three aspects of a scene: background, animation and foreground.



Fig. 3.3: A Sample Scene Composed of the Three Render Layers

The background layer is farthest from the camera, providing a backdrop for player and non-player character avatars (Fig 3.4). The background layer is comprised of terrain tiles (grass, wood floor, water, etc.), as well as tiles that the player should be able to walk over (stairs, walkways, etc.).

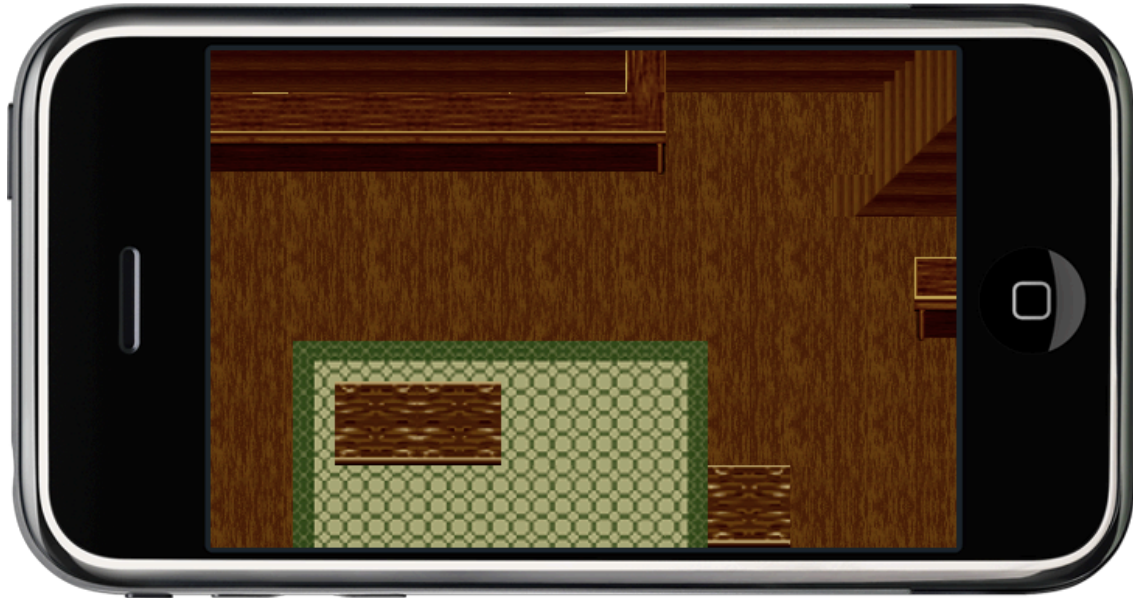

Fig. 3.4: The Background Sprite Layer for a Sample Scene

The animation layer, between the background layer and camera, is constituted of tiles that hold player and NPC avatar animations (Fig. 3.5). These tiles can be moved around the scene via player input or the game's scripting system.





Fig. 3.5: Animation Layer for a Sample Scene

Finally, the foreground layer is the closest layer to the camera, containing sprites that the avatars can walk behind (Fig. 3.6).



Fig. 3.6: Foreground Layer for a Sample Scene

Combined with the background layer, interesting graphical illusions can be created. For example, an avatar can appear in a bed through the combination of a

background tile of the bed, a foreground tile of the bed sheets, and the player's avatar aligned between them. In collaboration with our artists, we decided that a tile screen-size of 53 pixels would offer the best perspective for our players. This size creates a viewable space of approximately 6x9 tiles on the iPhone's 480x320 pixel screen.



Figure 3.7: Sample in-game scene showing the 6x9 tile view

We chose to use OpenGL ES 1.1 (<http://www.khronos.org/opengles/>) to render our graphics for a few reasons. OpenGL and DirectX are the industry standards for real-time computer graphics, and as aspiring game developers we wanted to gain as much experience as possible with industry standard tools. Secondly, OpenGL is the most resource efficient method for rendering graphics for our iPhone game. Because OpenGL is implemented through the graphics hardware, it is vastly more efficient than a

software-based renderer. The choice of using OpenGL ES 1.1 instead of OpenGL ES 2.0 was driven primarily by accessibility concerns. While OpenGL ES 2.0's programmable pipeline is more flexible than 1.1's fixed pipeline, it was only supported on the iPhone 3GS. Apple's Core Graphics libraries provide simple wrappers for common OpenGL API calls, however as an academic exercise, we chose to not use Core Graphics.

### 3.4.2 Implementation

The simplicity of the graphics engine design allowed for an exceedingly uncomplicated implementation. Mote's design and graphics style called for a small set of core functionality in the graphics engine. The engine needed to be able to display sprites, and set their positions in real-time. Animations were necessary for the player and non-player characters. Finally, sprites need to be layered on each other to create render layers.

Throughout the development of Mote, we attempted to adhere to Object Oriented design patterns as much as possible. Many features, like the Sprite Texture Manager and game state machines, are singleton objects. The design of the Mote engine was centered on manager classes that maintained a core set of information. Each of these managers maintained a separate and distinct portion of the game engine's functionality. The Audio manager, for instance, loads and plays sound effects, music, and dialogue. Partitioning functionality into distinct managers helped reduce coupling between classes. Managers also eased the process of changing underlying systems. For

example, the Audio Manager was changed to use OpenAL as an audio library part way through the development process. Because the Audio Manager class maintained a simple, generic interface, the changes required for using OpenAL were minimal and constrained to within the Audio Manager class. These design practices helped in making the graphics system simple and explicit.

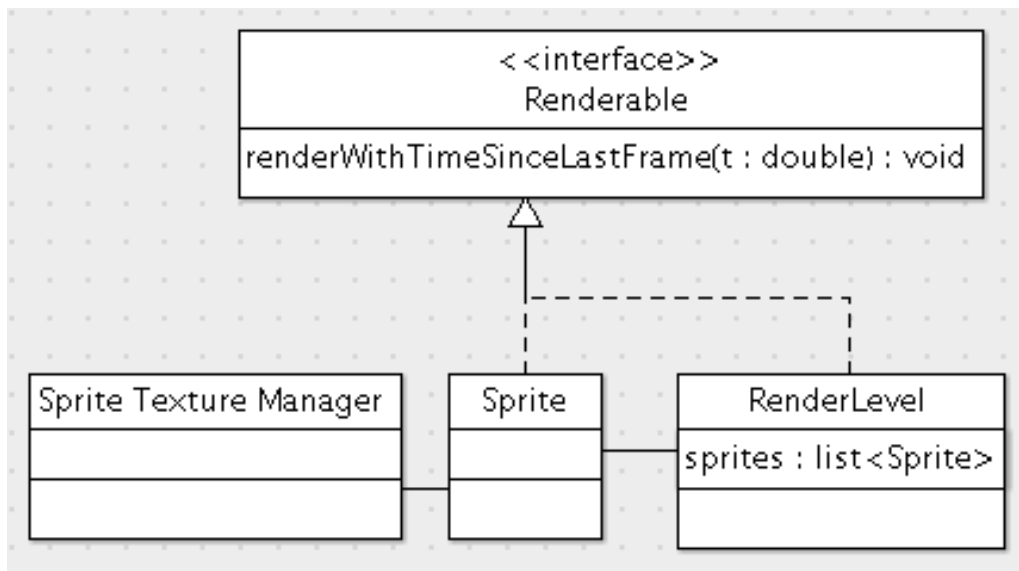

Figure 3.8: UML diagram of the graphics engine structure

Sprites were implemented through a square of two textured polygons. To prevent the same texture from being uploaded to graphics memory multiple times, a `SpriteTextureManager` class was created. This manager implements the singleton design pattern, and maintains a map of texture file names to their OpenGL ID numbers. The `Sprite` class gets the OpenGL ID from the `SpriteTextureManager` upon instantiation, as well as keeps track of the position of the `Sprite`. Each `Sprite` is added to a `RenderLayer` object.

Both the Sprite and RenderLayer objects implement the "Renderable" interface. This interface defines objects that can be rendered directly to the screen through the "render" method. Every frame, the update loop calls the render method on each of the render layers. The render layers implementation of the render method iterates through the sprites contained within the layer and calls each of the Sprite's render methods. Each RenderLayer is assigned to a specific Z index, which is translated into a translation along the Z axis. Because OpenGL allows for multiple transform matrices to be multiplied together and finally applied to the vertices, the RenderLayers translate the sprites they contain.

```
-(void) renderWithTimeSinceLastFrame: (float) time {
    glPushMatrix();
    //translate everything
    glTranslatef(0.0, 0.0, self.zOffset);

    //render all the sprites
    for (int count=0; count<[sprites count]; count++)
    {
        [[sprites objectAtIndex: count]
         renderWithTimeSinceLastFrame:time];
    }
    glPopMatrix();
}
```

Animations are implemented as a subclass of the Sprite class. Animated sprites change the texture value assigned to them after a specified interval. An animation loop can be specified as a set of frames in the animation. For example, a four-frame animation can play through completely, and then loop the last two frames indefinitely. This will yield an intro animation followed by a continuous looped animation. Because

the sprites for different animations can be held in the same class, it greatly simplifies keeping track of multiple, complex animations for a character.

### **3.4.3 Initial Results**

Overall, the graphics engine is the simplest solution possible while offering our artists as much flexibility as possible. The uncomplicated nature of the design helped tremendously in diagnosing and fixing bugs in the system. Analyzing the performance of the system was obviously dependant on the model and generation of iPhone/iPod Touch. For our benchmarking data we used a first generation iPhone 3G running iPhone OS version 3.1.2. We chose this because it exhibits roughly the average performance across all models, thus yielding a good benchmark for plausible use. Our goal number of frames per second was at least 30. Despite the streamlined nature of the graphics engine, our game averaged about 15 frames per second rendering a typical game scene (Fig 3.7) on the iPhone 3G. This was unacceptable as it gave the game a choppy feel that inhibited players' interaction with the game world. Optimization of the graphics engine became the focus of Graham's Computer Science MQP.

### **3.4.4 Optimizations and Tweaking**

Optimizations were focused around cutting down either the number of unique textures in the scene or the number of polygons in the scene as a means of improving performance. We found that as our scenes became more complex, and used more tiles,

the frame rate suffered dramatically. Conversely, adding more functionality through level scripting had minimal effects on the performance of the engine. Because of this, we determined that the graphics engine was the main bottleneck of the engine's performance.

Three different techniques were attempted as a means of improving graphics performance. Firstly, to drastically lower the texture memory necessary for rendering a scene, and to give the artists greater flexibility in their designs, we chose to halve the tile and texture size. Secondly, to improve the performance of rendering a scene, we chose to eliminate the use of polygonal geometry by changing the tiles to point sprites. Finally, we experimented with using Vertex Buffer Objects to hold tile vertex data in fast, graphics memory.



Fig 3.9: Sample Scene Used for frame rate benchmarking, created to showcase the effects of the optimizations made

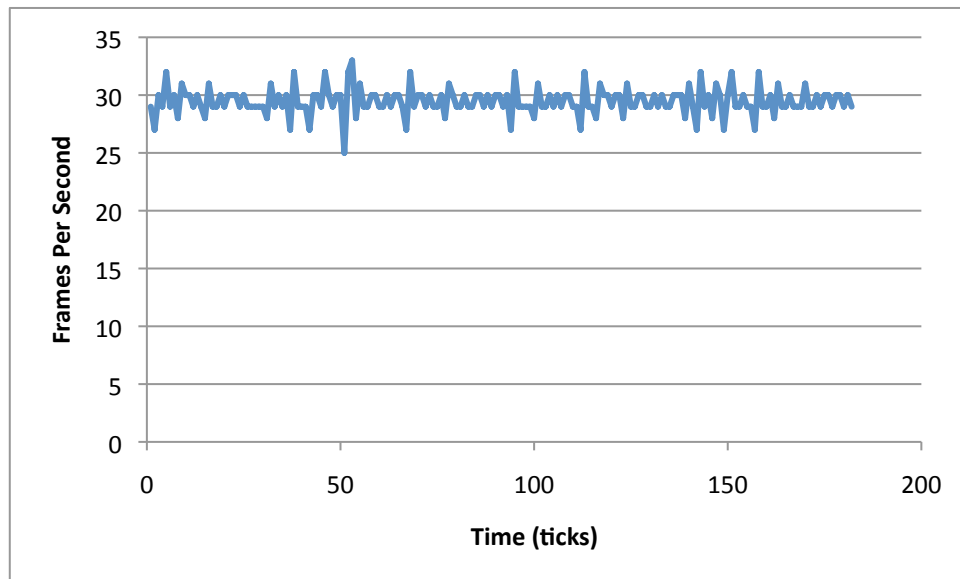

Fig. 3.10: Frame rate of the sample scene before modifications (Mean: 29.47 variance: 1.311)

### 3.4.4.1 Texture Artifacts Caused by Blending Function



The choice to use OpenGL has presented many interesting challenges in the development of our engine. Because we decided to use OpenGL ES 1.1 instead of OpenGL ES 2.0, all textures must be square, and have dimensions that are powers of two. Because our grid tiles are 53x53 pixel squares, we created all our textures as 64x64 squares. Because the images are scaled down to fit on the screen, and because the OpenGL texture blending function (`GL_LINEAR`) blends the edge pixels of a texture with nothing, textures would sometimes have strange border artifacts (Fig 3.9).



**Fig. 3.11: Artifacts caused by the `GL_LINEAR` Blending Function**

Eliminating the OpenGL texture blending function averted this issue. However, this caused some slight graphical artifacts (Fig 3.10).



Fig 3.12: Results of using GL\_NEAREST, note the rough edges

This graphical issue can be completely resolved while maintaining the blending function's benefits by using sprite sheets. Sprite sheets are a single image with multiple sprites on them, as opposed to separate images per sprite. Sprite sheets allow for the border pixel of each sprite to be blended with the tile that would presumably be next to it, thus removing the edge artifacts described. Originally sprite sheets were considered in the hopes of streamlining animations, however because textures must be square and have dimensions that are powers of two, (as a requirement of OpenGL ES 1.1) much of the sheets were blank space. This caveat ended up making sprite sheets less efficient than using separate images therefore we abandoned the idea. We originally planned on having animation metadata in a separate file for each animation, but since animations are controlled via the level scripting, this became unnecessary and bulky.

### 3.4.4.2 32x32 Pixel Tiles vs 64x64 Pixel Tiles

In analyzing the sprites used throughout one of our levels, we noticed that many sprites were identical to one another with some slight variations, and some were mostly transparent with a small portion of the sprite being used. This is extremely apparent on objects at an angle to the grid of the level, such as stairs. As a result, we concluded that halving the size of the textures for a level (from 64x64 pixels to 32x32 pixels) would dramatically increase the number of textures that were reused throughout the level. By changing the tile size, we maintained the number of unique textures per level while reducing the size of each texture by 75%. This change also, however, increased the number of vertices and polygons in a typical scene by approximately 300%.

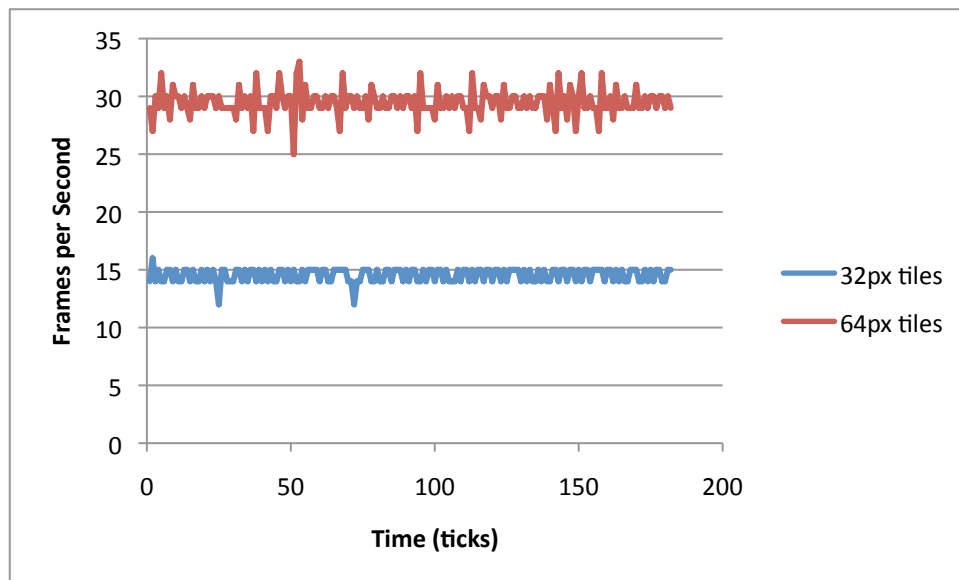

Fig. 3.13: Frame rate of the same scene using both 64 pixel tiles (Mean: 29.47 variance: 1.311) and 32 pixel tiles (Mean: 14.53 variance: 0.328).

This combined change resulted in approximately a 50% decrease in frame rate compared with the original implementation. This was very surprising to us considering

the significant amount of texture memory savings. We have concluded that the overhead for texturing each polygon, regardless of the size, is the bottleneck in high-polygon scenes.

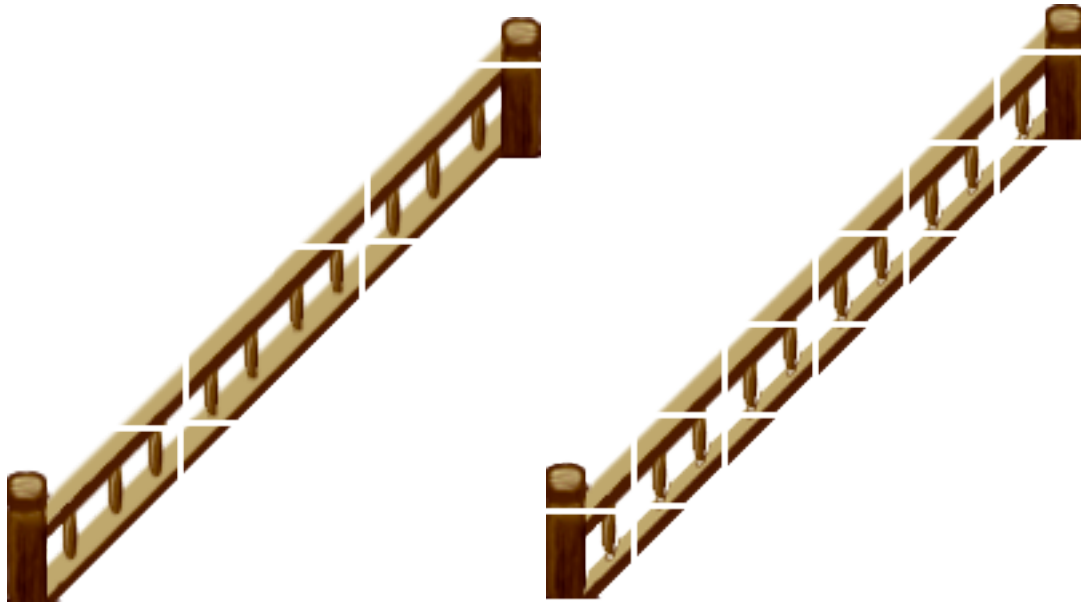

Fig. 3.14: The same banister represented as 6 unique 64x64 pixel tiles (left) and 7 unique 32x32 pixel tiles (right)

### 3.4.4.3 OpenGL Point Sprites vs Explicit Polygonal Geometry

Another optimization that we attempted was changing from pre-defined polygonal geometry to point sprites. We hypothesized that this would cut down significantly on the amount of vertex memory necessary. We also thought that because point sprites are viewed the same from any perspective, it would eliminate the need for much of the vertex transformations necessary to display a scene and thus give huge performance benefits. Quite counter-intuitively this added complexity to the graphics pipeline. Because the OpenGL implementation converts point sprites into two polygons

centered on the point's vertex, using point sprites caused roughly an 80% performance hit versus our original implementation.

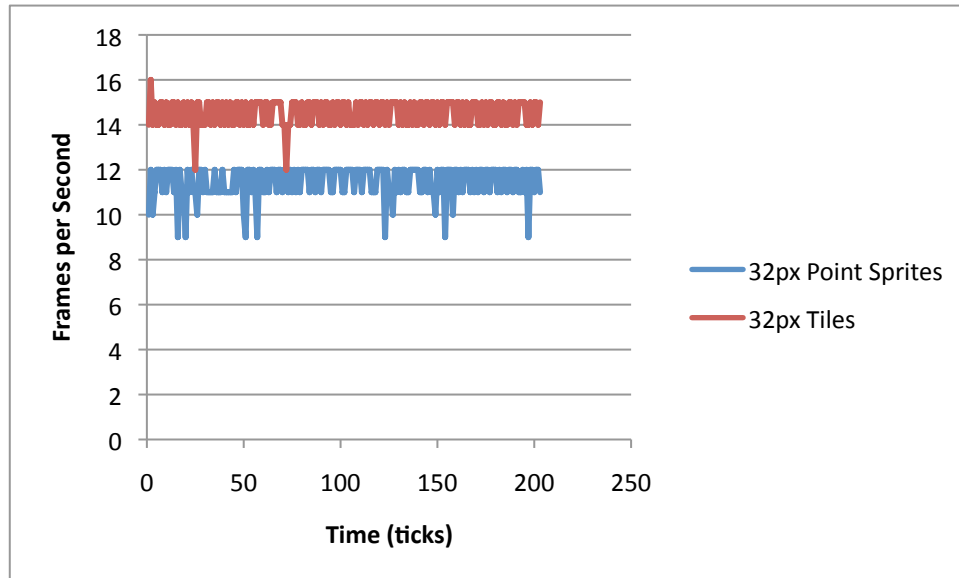

Fig. 3.15: Frame rate of the same scene using both point sprites(Mean: 11.46 variance: 0.527) and explicit polygons (Mean: 14.54 variance: 0.319).

#### 3.4.4.4 Vertex Buffer Objects

Finally, in an attempt to reduce the overhead associated with the increase in vertices, we tried using Vertex Buffer Objects, or VBO's. Vertex Buffer Objects maintain vertex information in high-speed graphics memory, removing the need to upload all vertex data every frame. Apple highly suggests the use of VBO's for high-performance graphics systems on the iPhone. We found that VBO's do not have any significant measurable impact on the frame rate of the graphics engine. We believe this is because the iPhone uses shared graphics memory. Our theory is that uploading vertices

to graphics memory is similar to the C "memcpy" function, which would not have a significant overhead considering the amount of vertex data being copied.

### 3.4.5 Conclusions

Overall our implementation was limited by the performance of the iPhone's graphics chip. Benchmarking our optimizations and changes showed that despite following Apple's best-practices for intense graphics applications, the iPhone can't render more than about two-hundred polygons consistently at 30 frames per second.

An optimization that was not implemented due to timeframe issues was the ability to flip and rotate textures. In observing the textures used for the benchmark level, we concluded that many could be created by a combination of horizontal or vertical flips and rotations of another sprite. This would cut down on the total number of sprites loaded into texture memory and thus theoretically improve frame rate.



Fig. 3.16:

Original Image

Horizontal Flip

Rotate 90 deg CCW

Rotate 90 deg CCW, Horizontal Flip

*Mote's* graphics style and level design ended up demanding more from the iPhone's graphics capabilities than it could handle. While our graphics engine was created with efficiency and scalability in mind, the number of textured polygons

required for a scene in *Mote* was more than could be rendered by the iPhone at 30 or more frames per second. The levels in *Mote* were designed to be moderately large and complex, which strained and tested the performance of the graphics engine. Levels designed with fewer entities and smaller scope would have maintained a reasonable frame-rate, however they would have required a modification to the game play and scale of *Mote*.

To test the possibilities of the iPhone platform, we ran several benchmarking tests. The first test was designed to test the effects of polygon count on frame rate. For this test we incrementally added textured polygons to the scene and measured it's effect on performance. Tiles of the same texture were incrementally added at random places in the scene. Culling of geometry that would be not visible was also temporarily disabled to give a more accurate reading of performance. The results of this test showed that as the number of polygons in the scene increases, the frame rate decreases exponentially (Fig 3.17). We also observed that the frame rate tends to decrease in large steps. This is very apparent in the drop from 30 frames per second to 20 frames per second at around 500 polygons. We believe that these jumps are caused by logic contained within the rendering pipeline or underlying decisions in the memory management module of the iPhone. Because the iPhone uses shared memory for the graphics chip and the system, the memory manager may have some underlying logic that dictates these severe shifts.

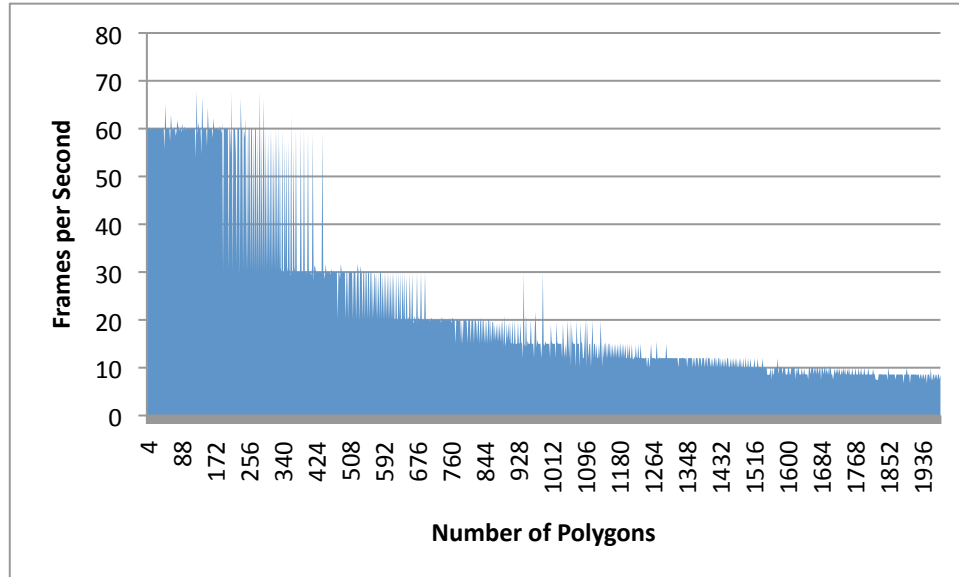

Figure 3.17: Frames per second as a function of the polygon count for the simplest possible scene.

We also wanted to know what effects having many unique textures had on a scene's performance. We conducted a similar study as the polygon test, but instead of using the same texture, we assigned a new unique texture to that tile. This coupled with disabling culling gave us a good estimation of the texture performance capabilities of the iPhone (Fig 3.18). We found that unlike the exponential relationship between polygon count and frame rate, the relationship between the number of unique textures in the scene and the number of frames per second is linear. We believe this linear relationship is caused by the sharing of graphics and system memory in addition to the internal algorithms of the OpenGL hardware implementation. When undergoing these tests, the iPhone performance tended to behave sporadically, giving inconsistent relationships and outliers in the data gathered. Because the iPhone runs multiple daemons simultaneously with the running application, performance spikes and drops



are quite frequent. The data gathered cannot account for these irregularities, however we believe that it can describe a general trend or relationship between two values.

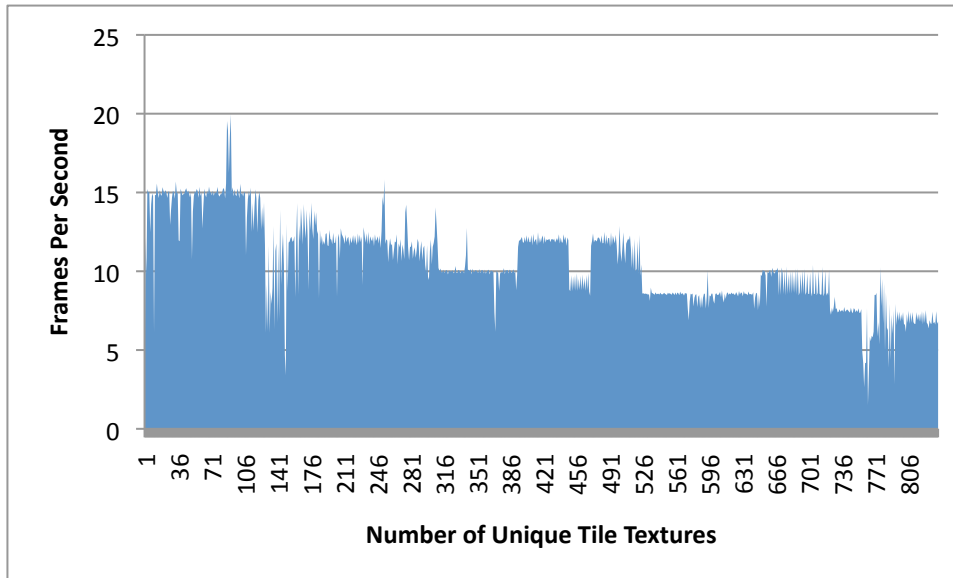

Figure 3.18: Frames per second as a function of the number of unique textures in a given scene.

The iPhone's graphics chip turned out to be significantly more underpowered than was anticipated. This hindered the functionality of *Mote*, as well as the possibilities of the game engine. This exemplifies the need for iPhone games to be designed with graphics performance in mind. Developers should limit the number or complexity of the graphical effects used in their game as much as possible. Games should use simple graphics and rely more heavily on interesting game play mechanics. The lack of advanced graphics capabilities on the iPhone will encourage creative, fun games based on simple concepts.

### 3.5 Level Editor

In order to create the game's levels in an expedient manner, the team decided to create a custom level editing tool. The original idea was to have the data for each level stored in its own bitmap image file. At first, this seemed like a good idea; everything in a level, such as collision walls and texture tiles, is aligned to a grid, which matches up perfectly with an image. The colors of each pixel in the image file would represent something in that level's cell, such as background texture, foreground texture, texture orientation, collision wall shape, or NPC entity ID. However, we quickly realized that making any sort of complex level would be an extremely tedious process for the artist making it; editing a bitmap image on a color-by-color basis without any sort of visual aid would take far too long. For this reason, we decided to write our own custom level editor to create levels specifically for our game, Mote.

The Level Editor was written in Java using Eclipse. The entire process to create a simple program to lay tiles in a map and save the data to a file took about three days. The interface was minimal and not user-friendly, but it got the job done. The main functionality of the Level Editor was to place background textures, foreground textures, and collision walls in a grid that would be loaded by the game. In addition to this functionality, the Level Editor could also do bulk movement of tiles, copy/paste, and texture groups. These functions were added in to help the artist speed up productivity.

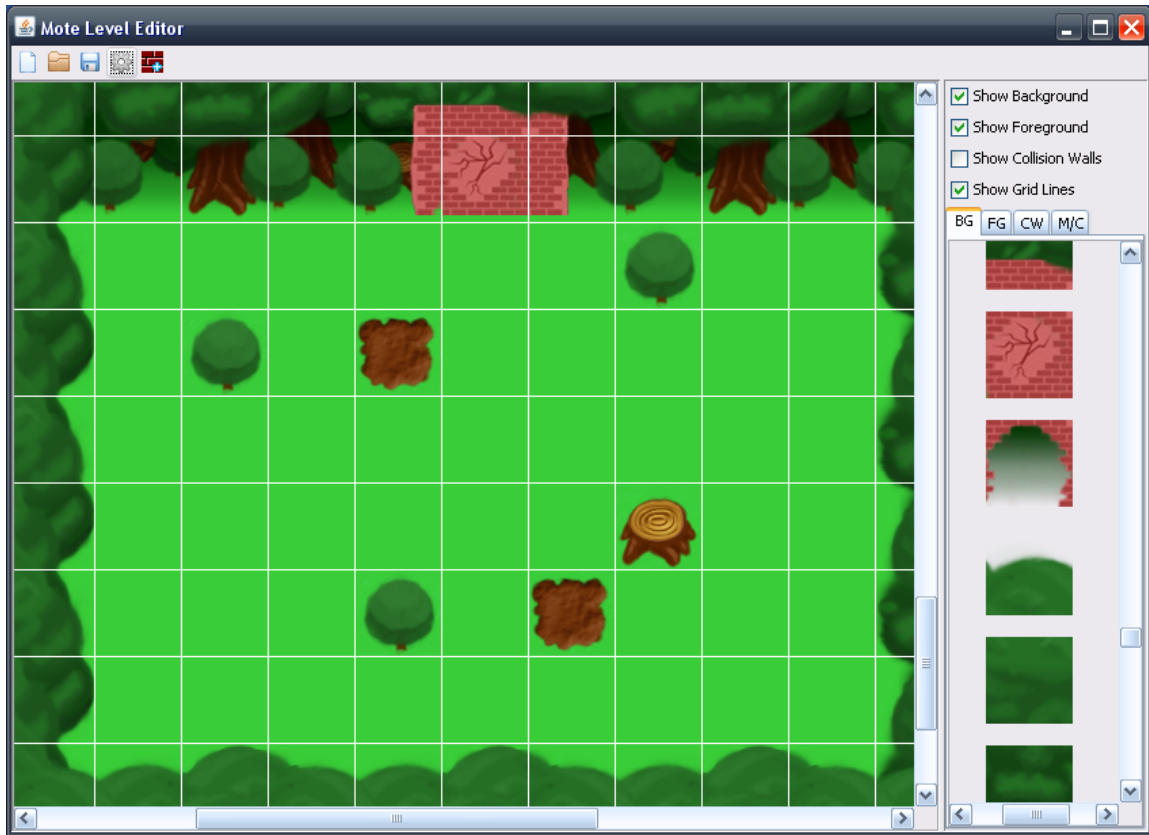

Fig. 3.19: A screenshot of the level editor in action, showing the first level.

The grid in the middle shows what the level will look like in the game. On the right there is a series of check boxes that display and hide the different layers of the level: foreground tiles, background tiles, and collision walls. Underneath that is the list of all textures that appear in the level. To place them in the grid, simply click on a texture to select it, and then click on a cell in the grid to change that tile to the selected texture. The tabs above the list of textures show what tool is currently selected. Above the level grid are the tool bar buttons for (from left to right): new level, open level, save current level, change level settings and import textures.

The program saves one main file in LEV format (custom to the Level Editor), which contains metadata such as width, height, texture size, and number of textures.

There is also an LVD (level data) file that contains the actual level data, the position of every background texture, foreground texture, and collision wall shape. The game then reads these files and reconstructs the level exactly as it appeared in the level editor.

Although it wasn't perfect, using the Level Editor saved valuable time, compared to the artist editing the color data of an image file on a pixel-by-pixel basis. It also gave the artist a visual representation of the level so they could see it before it was imported to the game.

### 3.6 Lua

Our game uses a scripting library called Lua (<http://www.lua.org>) for our levels. Lua is a widely used software library that is very useful for level design and event scripting. Lua also can be used for any part of a game that needs to be rapidly prototyped and changed without long compile times. It also integrates quite well with C, which makes it convenient to call C functions from within a Lua script.

Lua sped up and simplified our level creation and improved encapsulation of how a level actually works. The Lua file does not deal with anything outside of the level itself, which would be significantly more difficult if the levels were made in Objective C like the rest of the game. A system of C functions "hook" into the Lua file and allow the script to operate without directly interacting with the game engine. This allows us to limit the amount of control that the Lua script has over the game proper, while allowing it to control all of the parts of the level that it needs to.

### 3.6.1 Scripting

The Lua scripts that Mote used changed over the course of the project. At first, the scripts were written chronologically according to when in the level each puzzle would be completed, with only one method for the game to communicate actions to the script. This structure made it difficult to do much with event scripting, as there was no way for the game to inform the script that an event had happened. One implication of this was that we had no real event-based code at this point; we only had timers that simulated events through careful control of when things happened. This structure was not usable or extensible enough for our purposes, so we changed it into an event-based framework as soon as we realized how much the system limited us. The event system will be described in more detail elsewhere.

After events were implemented, the script was split into two basic parts: initialization and event-driven behaviors. The event-driven behaviors were the things that happened as a result of events in the game. The initialization was the various things that had to be done to start the level. For example, the following is taken from the initialization of the first level:

```
--Create the npcs, give them animations.  
metal_id = createMote("metalheadIdle%d", 3, 5, 1);  
babby_id = createMote("babyIdle%d", 9, 5, 1);  
sleepy_id = createMote("sleepGuySnore%d", 4, 5, 2);  
emo_id = createMote("emoIdle%d", 6, 5, 1);  
guard_id = createMote("guardIdle%d", 6, 5, 2);  
mcsickle_id = createMote("malletIdle%d", 6, 5, 1);
```

The first line is a Lua comment. The six statements create each mote that exists in the first level and assigns its unique id number to the correct variable. The arguments to createMote are, in order: filename, number of frames, animation speed, frame offset. The filename is the name of the file that the animation is from, formatted to include a number for a frame number. The number of frames is the total number of frames in the animation, and the animation speed is how many frames per second the animation runs at. The frame offset is the frame that the animation should start at, in case there is a part of the animation that should be skipped during loops. We found that this set of parameters provided all the power that the script needed when creating a mote. Later in the script we set each mote's dialogue:

```
--Set everyone's dialogue
dialogue(metal_id, "Argh. Need some music.\n It's too
quiet.");
dialogue(babby_id, "Agoogoo.\n Agoogoo.");
dialogue(sleepy_id, "Zzzzzzzzzzzzzz. Why yes\n I'll
have a chili dog.");
dialogue(emo_id, "My darkened gaze reflects the\n
gossamer wings of the raven. |I wrote that poem
myself.");
dialogue(mcsickle_id, "I... uh... aint moving. Nope.\n
No motivation.");
dialogue(guard_id, "NONE SHALL PASS.");
```

The dialogue function takes in a mote's id number and a formatted string for dialogue, and sets the specified mote's starting dialogue.

Within the event-driven behaviors part of the script, we have a few methods that can show how we made the scripts. Calls similar to this one were used frequently:

```
playAnimation(metal_id, "metalheadIdle%d", 1, 3, 5, 0, 0, NO_EVENT);
```

This call plays an animation, using the following arguments: mote id, filename, start frame, end frame, animation speed, frame offset, loop offset, and event identifier.

Mote id is the identifier for the mote that is to be animated. Filename is the filename of the animation to play. Start and end frames are the frames that the animation should start and end at, in case we need to only loop through a short section of the animation.

Animation speed is how many frames per second the animation runs at. Frame offset and loop offset are the frame numbers to start the animation at the first time and each later time, respectively. Event identifier is the identifier for the event that happens

when this animation finishes. Another method that shows the general pattern that our script follows is `moveMote`:

```
moveMote(metal_id, 9.5, -31.25, 0.1, METAL_HIT_BRICK_WALL);
```

This method moves a mote to a position, and uses the following arguments: mote id, x position, y position, speed, event identifier. Mote id is the identifier of a particular mote to move. X and Y positions specify where to move the mote. Speed is the speed at which to move the mote. The player's mote moves at 0.05, making this movement of 0.1 very fast. Event identifier, as before, is the name of an event to execute once the mote reaches its destination.

### 3.6.2 Lua Conclusions

Mote successfully utilized Lua. We were able to spend much less time on our scripting engine than we initially planned on due to not having to write a script parser from scratch. It took some time to figure out how to get Lua to work on the iPod, but using Lua still took far less time than writing an engine would have. The iPod development environment doesn't have native support for scripting languages, so we had to compile the Lua source code into our project and bundle our script files with our other resources. Lua was most likely the best solution for our need to script the levels rather than hard-code them. Our scripts grew very rapidly, as did the hooks that they used. While using Lua helped speed up our development of levels, we could have avoided many of the headaches it caused if we spent more time designing exactly what our scripts needed to do before we started implementing.

### 3.7 State Machine

Mote uses a simple and powerful state machine architecture to handle game states. A UML diagram of this architecture follows:

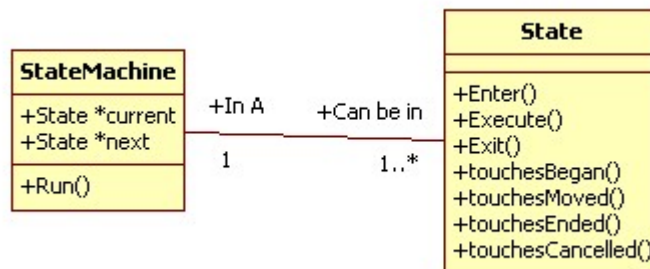

Fig. 3.20: A UML Diagram of our state machine.



A particular StateMachine can be in any one of a number of different States. Each of these States can only be associated with a single StateMachine. When the StateMachine is given a State to Enter() next, it Exit()s the current State and Enter()s the new one. When the StateMachine isn't Enter()ing a State, it Execute()s it. All of this functionality is held in the Run() method. The four "touches" methods in the State are iPhone standard methods that handle user input.

This model is a fairly standard one, and is quite versatile. Because the machine does so little (it just calls Execute() during normal operation) it can be used for many different tasks. Mote contains many different States, which allow the game to easily and seamlessly go from a dialogue to the game proper to the pause menu, all without a hitch. For the large differences in what each State needs to do, there needs to be a structure that's quite versatile like this one is.

### 3.8 Menu System

The menu system that we use is actually quite simple:

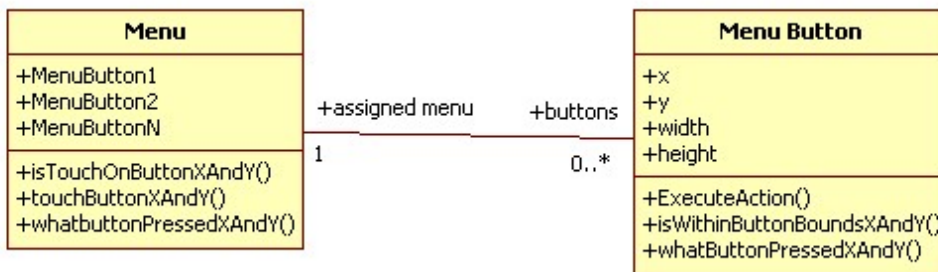

Fig. 3.21: A UML Diagram of our Menu System

If a menu is needed in the game, its Menu Object is initialized. When the player touches the screen, the game asks the Menu if that touch was on a particular MenuButton. When a button is touched, it executes its ExecuteAction method, which completes the button's assigned task. This system is quite versatile, and it allows buttons to be moved during the game if needed. It also can be extended quite easily, as the system is fairly light. Due to this structure's minimal interface with the game, there are very few things that need to be implemented to extend this structure. The Menu only requires the implementation of three methods and the inclusion of an array to be extended. The MenuButton requires 3 methods and the position and size fields to be extended.

This system has a few weaknesses that were not anticipated when it was implemented. The largest one is the large amount of simple work to add a new menu. Each Menu and MenuButton is its own class, so a menu with 3 options on it requires 4 new classes to create. This is more time-consuming than it needs to be. It would have been a better idea to use a simpler structure for buttons than a full class. A C-style struct would have been simpler, though it would require buttons to have an identifier as well as position and size.

### **3.9 Physics**

The collision system of Mote is made up of terrain and entities. The terrain is the static part of the level that does not move, through which entities cannot pass. Entities

are the dynamic part of the level, thus they do move. In the case of Mote, the only entities are the player's mote, and the NPC motes.

To calculate potential collisions and how to handle them the task must be delegated out to a third class, a CollisionHandler, which contains the information about all the physics of the game. Not only does this help maintain modularity and extensibility of the game, but it prevents cyclic dependencies--a sort of recursive reference within header files. An entity should not have information about the terrain, and vice-versa, because that would give too much responsibility to that particular class. World objects (entities and terrain) should only be concerned with their own behavior and information (movement, geometric shape), and let an external class handle interaction between them.

### 3.9.1 Terrain

The terrain of Mote is a grid of rectangular-shaped cells that spans the entire level, referred to as a "LevelGrid". Each cell in the grid is the same size, which makes it quick to check which cell contains a particular point in the world space. Assuming the LevelGrid originates at point R, given the cell dimensions W and H for width and height, to find the cell that contains the point p, use the following equations:

$$c_x = \text{truncate}\left(\frac{p_x - R_x}{W}\right) \quad c_y = \text{truncate}\left(\frac{p_y - R_y}{H}\right)$$

Fig 3.22: truncate(n) simply drops all numbers after the decimal point. So truncate(15.943) returns 15.

...where  $c_x$  is the grid column, and  $c_y$  is the grid row, assuming the indexing of the columns and rows starts at 0. Therefore, using a grid with cells of width and height of 64 starting at the origin (0, 0), to find the cell that contains point (345, 890) simply substitute the numbers into the equation:

$$\text{truncate}\left(\frac{345-0}{64}\right) = \text{truncate}(5.39) = 5$$

$$\text{truncate}\left(\frac{890-0}{64}\right) = \text{truncate}(13.91) = 13$$

So the cell [5, 13] contains the point (345, 890). This is important to speeding up collision, because it can quickly filter out any cells that it knows cannot possibly be colliding with an entity.

Every cell in the grid has one CollisionShape associated with it. A CollisionShape has one of six values:







0 (Empty)	
1 (Square, Full)	
2 (Top right corner triangle)	
3 (Top left corner triangle)	
4 (Bottom right corner triangle)	
5 (Bottom left corner triangle)	

Fig. 3.23: White space is empty, gray is solid terrain

The entirety of the terrain is made up of these simple geometric shapes, aligned to their respective cells. Putting together combinations of squares and triangles will form a crude collision map for the world that relates to and is representative of the graphics on the screen.

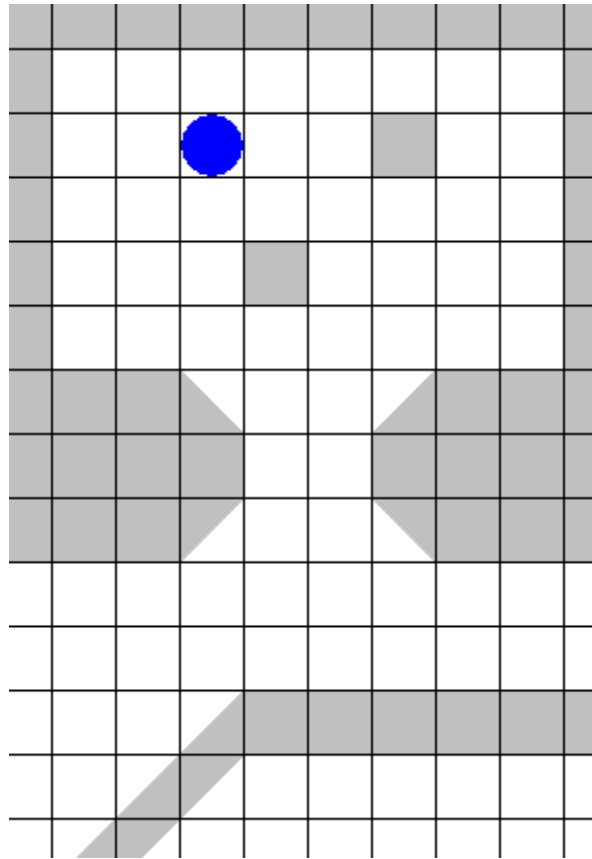

Fig. 3.24: The blue circle represents the player mote

The world of Mote is not involved enough to warrant a more complicated terrain system, so this system is acceptable and accurate.

### 3.9.2 Entities

The entities of Mote are the mote characters themselves. There are two types of motes: the player mote and the NPC (non playable character) motes. The two behave in the same manner with respect to movement and collision, but there are some key differences that require two separate classes to represent them. The CollisionHandler represents all entities as circles.

All motes have a current position  $p$ , and a target position  $t$  that they walk toward at some speed  $s$ . They also have a boolean data field  $w$  that indicates whether or not the mote is currently walking. When a mote is told to walk to a position,  $w$  gets set to true, and  $t$  is updated to that position. Once the mote reaches its target,  $w$  is set to false so that it stops moving. The speed value  $s$  is represented in world coordinates per second, to maintain frame independence. In psuedo code, the movement function looks like this:

```
function moteMove ()
    if w then
        distance := distanceBetweenPoints(p, t)
        amount_to_move := s * numSecondsSinceLastFrame()
        if distance < amount_to_move then
            p := t
            w := false
        else
            p.x += (t.x - p.x) * amount_to_move/distance
            p.y += (t.y - p.y) * amount_to_move/distance
```

```
        end
    end
end
```

The player mote keeps to this movement system, but also has an extra field for touch input. It has an input point  $i$  that is represented in screen coordinates, as well as another boolean field  $d$  that indicates whether or not the player is currently touching the screen. When the game controller registers a touch, it sets  $i$  to the point touched, and  $d$  to true. When the touch is released, it sets  $d$  to false. In psuedo code, the player mote's touch functions looks like this:

```
function onTouch (touchPos)
    i := touchPos
    d := true
end
```

```
function onTouchRelease ()
    d := false
end
```

And the updated move function for the player mote looks like this:

```
function playerMove ()
```

```
if d then
    t := convertScreenToWorld(i)
    # remember that i is in screen coordinates
    # and t is in world coordinates
    w := true
end
moteMove ()
end
```

NPC motes do not behave and differently from how the player mote behaves in terms of movement and collision. The major difference is that NPC motes initiate movement in response to events, whereas the player mote responds to touch input. NPC motes have additional data fields for current dialog text and event objects to be called when certain things happen, but other than that they are the same as a generic mote entity.

### 3.9.3 CollisionHandler

Collision detection is handled by a class called CollisionHandler. The CollisionHandler has all the information about the entities and terrain in the level. The reason for outsourcing this responsibility to an external class is that entities and terrain should not reference each other. Doing so would break modularity (each class must do one thing, do it well, and not have to unnecessarily depend on other classes), and it is



actually impossible for the Mote class and the LevelGrid class to reference each other, because it would cause a cyclic dependency.

A cyclic dependency is when two class files (in this case it would be Mote.h and LevelGrid.h) attempt to import each other. Both classes depend on each other, and thus need to know about the other's class definition. In objective-c code, it would look like this:

#### **Mote.h:**

```
#import <Foundation/NSObject.h>
#import "Point.h"
#import "LevelGrid.h"

@interface Mote : NSObject
{
    Point currentPosition, targetPosition;
    bool isWalking;
}

- (id) init;
- (void) moteMove;
- (void) handleCollisionWithGrid: (LevelGrid*) grid;
```

```
@end
```

### **LevelGrid.h:**

```
#import <Foundation/NSObject.h>
```

```
#import "GridCell.h"
```

```
#import "Mote.h"
```

```
@interface LevelGrid : NSObject
```

```
{
```

```
    int gridWidth, gridHeight;
```

```
    GridCell*** cellMatrix; // two dimensional array of
```

```
cells
```

```
}
```

```
- (id) initWithLevelFile: (NSString*) fname;
```

```
- (GridCell*) getCellAt: (Point) p;
```

```
- (void) handleCollisionWithMote: (Mote*) entity;
```

In this example, Mote.h is attempting to import the code from LevelGrid.h, but at the same time, LevelGrid.h is attempting to import the code from Mote.h. Luckily, the

compiler can detect a cyclic dependency such as this and stop the linker from going into an infinite loop, but it will still cause an error because there is no proper way to build it.

For this reason, the CollisionHandler takes care of all interactions between entities and terrain. Neither the Mote class nor the LevelGrid class know about the CollisionHandler class, they only know about their own tasks and properties. The CollisionHandler is controlled by the GameController, and is invoked every frame when collision detection is needed:

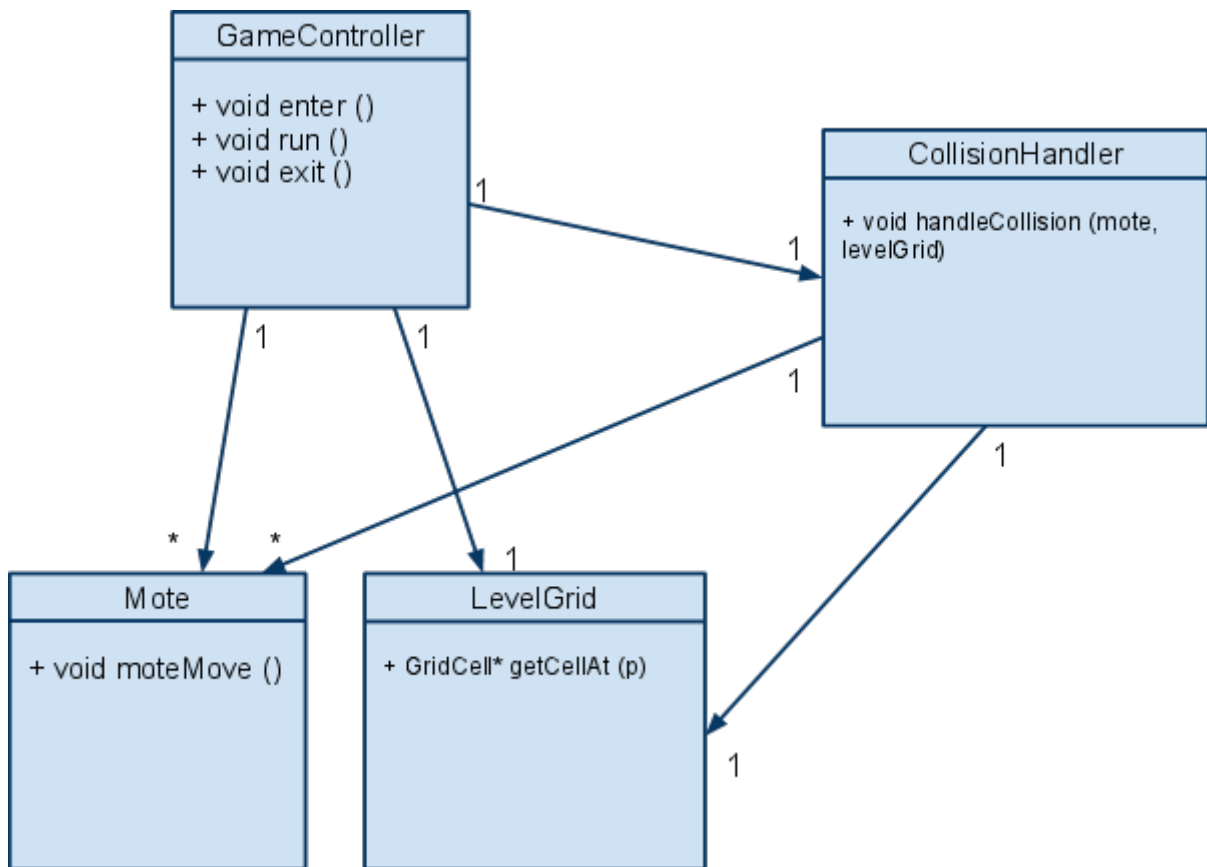

Fig. 3.25: UML diagram of relationship between classes

The GameController object depends on all three of the other classes: CollisionHandler, Mote, and LevelGrid. CollisionHandler depends on the physics objects: Mote and LevelGrid. The physics objects do not depend on anything but themselves, which is how it should be.

### 3.9.4 Collisions

There are two types of collisions in the game: mote-mote and mote-terrain. All motes are circles, and terrain is made up of squares and right triangles, so there are only 3 possible combinations of geometric shapes to calculate collision between: circle-circle, circle-square, and circle-triangle. Collision checking between these basic shapes is simple and fast, thus takes minimal CPU resources.

Collision detection between two motes is the simplest. To check if two circles are overlapping, compare the distance between their centers. If the distance is less than the sum of their radii, then they are overlapping.

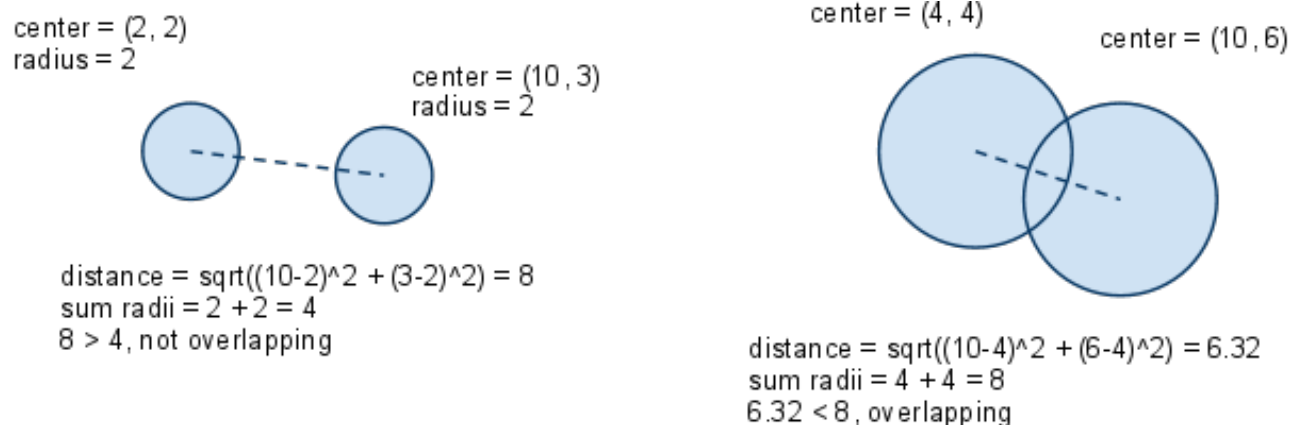

Figure 3.26: Collision detection between two circular bodies.

When the CollisionHandler detects a collision between the player mote and an NPC mote, it places the player mote away from the center of the NPC mote by an amount equal to the sum of their radii. This will place it just on the border of their circles, so that they are no longer overlapping.

When the CollisionHandler checks for collision between the player mote and terrain, it only checks against the grid cells that the mote is occupying. Because the cells are aligned to a grid, and are all of equal size, it can quickly filter out any unimportant terrain cells that it knows cannot possibly be colliding with the mote. Using the equations above to check what cell contains a world coordinate point, the collision handler can quickly find the four cells that it needs to check:

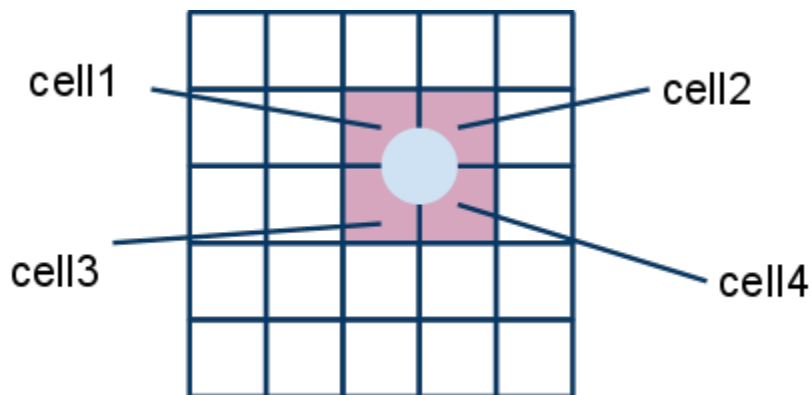

Figure 3.27: The four cells that the Mote is occupying.

Because the mote entity is the same size as a grid cell, the CollisionHandler can simply check what cells contain the four corners of the bounding box of the mote's circle, and only check for collisions against those cells. Theoretically, the LevelGrid could

be of infinite size, and it would not affect performance, because CollisionHandler will always only focus on four cells at a time.

### 3.10 Sound Engine

Our sound engine uses the OpenAL audio library with some functions to pare down unnecessary functionality. OpenAL is a very large and versatile library, and most of that versatility is not needed for our game. The sound engine we used comes mainly from a tutorial on 71 Squared (<http://www.71squared.com/2009/05/iphone-game-programming-tutorial-9-sound-manager/>), a blog about iPhone development. We added some functionality that we needed that was missing from this tutorial, but we stayed pretty close to it in the end. (<http://videos.71squared.com/6440991>).

Our sound engine is split into two basic parts: a sound playing engine and a music playing engine. The main difference is that the sound playing engine is better optimized for playing short clips, like sound effects, whereas the music playing engine is designed to handle longer clips, like ambient music. The basic structure of the sound engine is as follows: The SoundEngine contains a list of sound sources to play sounds from. The iPhone can handle up to 32 separate sounds playing simultaneously, so our structure allowed for 32 sound sources. The SoundEngine also contains a list of all of the currently loaded sounds for quick reference. To play a sound, the game gives the SoundEngine the name of the sound to be played and the SoundEngine assigns that sound a sound source. The sound plays once and then stops, unless certain flags are

set. If the sound name given isn't registered with the SoundEngine yet (because it hasn't been loaded in yet, for example) then the engine doesn't play any sound or assign it a source.

Music works slightly differently. The music to be played must still be registered with the engine, but the whole clip is not loaded at once. The iPhone's CoreAudio framework provides support for streaming music, which is ideal for large sound files like ambient music. Once loaded, the SoundEngine can play a single track of music at a time. By using streaming audio, we avoid using much memory at once, which is very important for such a memory-limited system.

For format, we decided to use Apple's core audio format, or .caf. This format is ideal for working with the iPhone, and requires no processor-intensive decompression or other related problems while still allowing a number of compression schemes, should they be desired. We went through several iterations of sound file use before settling on .caf. We first tried to use .mp3, as this format has a very high compression ratio without losing too much quality. We found quickly that in order to use .mp3 files, we would have to use a very complicated decompression technique that would take up more processor time than we had. In addition, decreasing the size of the music file does not decrease the amount of memory it uses, as the file has to be decompressed to be read. To save ourselves the additional hassle of creating a decompression algorithm that would most likely be too costly to implement and give little benefit, we decided to forego compression entirely and use the uncompressed .caf file as our standard audio

file. We used this format to improve efficiency and to leave open the option of compression in case we needed the extra space at a later date.

Mote's audio engine succeeded at creating a powerful framework that was limited enough to be easy to code, while retaining all the power that the game required. The use of separate schemes for playing short and long clips especially helped improve the efficiency and memory use of the engine. We really didn't require much in the way of functionality, but the engine was able to ably handle the variance that we gave it. One fact that would probably have helped the engine had we known it beforehand is that compressing sounds doesn't affect the memory footprint of a sound. Far too much time was spent on figuring out a decompression algorithm before we realized this. Were we to recreate this type of sound engine, we wouldn't spend so much time on trying to reduce the size of the sounds; rather, we would spend our time improving the efficiency of the engine in other places, like in sound source allocation, or sound loading.

### **3.11 Particle System**

Particle systems are an efficient, easy way to create interesting visual effects. Many abstract shapes can be easily simulated through particle systems. For example water, fire, smoke, stars, and other plasma-like effects can be easily created with a particle system. Particle systems simulate the interaction of various infinitesimally small particles, represented as single points in 3d space. The particle system then renders



point sprites at each of these points through OpenGL. The size, color, and transparency of the point sprites can be modified over time to create interesting effects.

For Mote, we wanted a particle system to simulate the smoky look of the mote characters (Fig 3.25). We also wanted a system that had the flexibility to perform an array of visual effects. For our system we wanted particles to appear in semi-random positions behind the character, with a semi-random size and transparency.



Fig. 3.28: The particle effect creates a smoky trail behind the mote character

These particles would be altered through a series of frames by changing their positions, sizes and transparency through separate functions. With a combination of these alterations, a fairly convincing smoke effect is created.

In designing the particle system of Mote, we observed the systems of pre-existing iPhone engines. We decided that, while it would be interesting to create a particle system on our own, it would not be particularly innovative, academically

interesting, nor challenging. We chose to modify the system created by the developers at 71squared.com (71Squared, 2009, <http://www.71squared.com/2009/05/iphone-game-programming-tutorial-8-particle-emitter/>) to meet our needs. This system was proven to be a fast and reliable system designed for the iPhone, which offered exactly what we needed. It uses point sprites and stores the color, size, and position information for each particle in Vertex Buffer Objects for maximum efficiency. The system is also written in C, which we have found tends to be a bit faster than Objective-C. This saved us a measurable amount of time, which we spent towards polishing other aspects of the game. This aspect of the game engine taught us that we shouldn't always re-invent the wheel. Sometimes finding a proven solution to a common problem is better than attempting to solve it for the sake of solving it.

## 4 Artistic Designs

During the development phase, our intention was to make a game that could be sold on the App Store. We wanted *Mote* to both look attractive and like a casual game to attract those that typically use the App Store. Friendly appearances, soft edges, and bright colors are all aspects of this art style. The game's visuals are all based around the characters, which all resemble little dressed-up puffballs. When introducing our animator during C-Term, the words, "Like Kirby, but softer", were used to describe how the characters should look.

The characters and scenery in *Mote* are the product of an art student's dream. The environments which the player explores are designed to be plausible enough for the player to know how to correctly interpret them and know how they work, but like dreams, they also have some unusual aspects. In the second level for example, the boat that the player visits is an incredibly short walk from the bar. In the first level, there's a baby, without any apparent mother or father, playing in a field. Also in the first level, The Metalhead is capable of busting down a brick wall, a feat not so easily done in reality.

Our first concern when creating the art style for *Mote* was the size of the iPhone screen. Every pixel given to the device will be rendered. However, it would be hard to see anything particularly small or intricate. A 480x320 screen cannot display very much detail. As a result, objects are simple in design and color.

## 4.1 Character Design

We have a grey mote template that all our characters start with. Then each character is shaded with one of our twelve colors (fig 4.1 below), and then given an appropriate prop. Basing every character on this template simplified our character design and animation process.

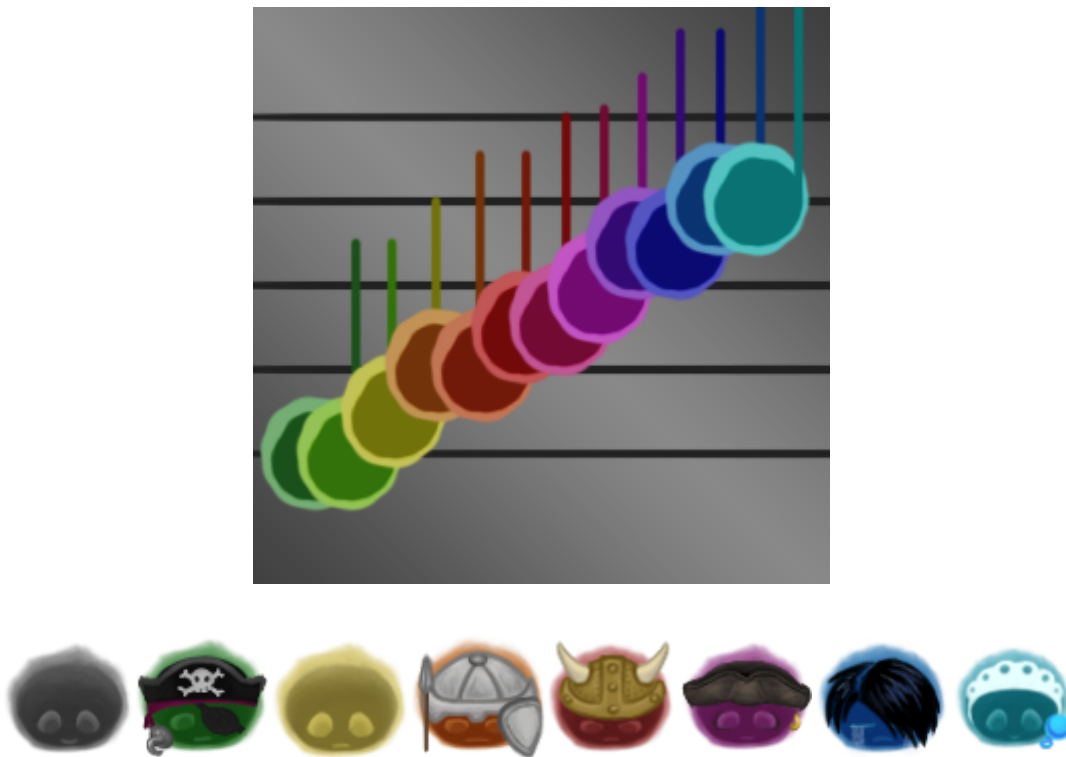

Fig 4.1: An assortment of characters showing our character color variety.

Another advantage to using a template for characters is their consistent round shapes are easily identifiable against level backgrounds. The addition of colors and accessories allowed all of the variation between characters we'd ever need and still

didn't deviate from the general appearance of the characters enough for them to be mistaken for scenery.

### 4.1.1 Characters

The approach we took to creating all of our characters was somewhat chaotic, as is perhaps appropriate for dream-based characters. Some characters were designed around the puzzles they're associated with. Some other, more important characters were designed before their puzzles and occasionally persist through multiple puzzles. The latter ended up being appropriately more interesting.



**Mote: The Protagonist**

Mote is the manifestation of Moe (the sleeping student) within his own dream. Moe is a music student who has fallen asleep in class. The goal of the game is to discover representations of musical concepts within the dream in hopes that Moe will be able to learn enough for his final.

Aside from the backstory, the characters Moe and Mote aren't fleshed out at all. This is similar to the Zelda and Half Life series of games in that the main character is mostly undefined. By not emphasizing any particular characteristics of the main

character, we allow the player's imagination to fill in the gaps however they wish. He is the only grey entity in the game, so there's no question that this is the player character.



The Metalhead

The Metalhead is an example of a character that was created for a puzzle. His was also the first puzzle created for the game and was used as an example to demonstrate our intentions for using music style as our puzzle mechanic. While he might be very simple for a character, he's our best example of what we intend with our puzzles.

The Metalhead has no backstory to speak of. His sole purpose is to be the first puzzle the player completes. He represents the metal riff (he also gives it to the player) and this riff is also used to solve his puzzle. He demonstrates that metal is used to enrage or escalate the emotions and interactions of others.



The Dread Pirate Soggy Rumpot: A Plot Character

Soggy is an example of a character who was developed before his puzzle. The concept for him was an absurdity that struck one of us suddenly: Several classifying accessories of a pirate are a peg leg, pirate hat, parrot, hook, eyepatch, and beard. So obviously the ultimate pirate would have two eyepatches, two peg legs, two hooks, two

parrots, a beard, and a pirate hat. Unfortunately, putting all of that in to one tiny character sprite would effectively cover the mote template (it would also look ridiculous), so we settled for one hook, one eyepatch, and the hat. A parrot exists, but appears with a different character.

The backstory for Soggy is that he is (or was) in search of the legendary Pirate Shanty and would not stop for anything until the shanty was found. He's been through quite a bit and has a number of stories to tell (unfortunately, many stories that were thought up weren't drafted because they weren't quite appropriate for the tone of our game.)

The first puzzle created for Soggy was actually less of a puzzle and more of a story choice. When the puzzle was first created, we assumed that the player would have four riffs by this point: The first two, Classical and Metal. Then two new ones, Jazz and Rap. Playing any one of these riffs would elicit a response from Soggy that would indicate what the riff meant to him. For some of the riffs, if played twice, they would advance the story in a certain direction. Classical, for example, would inspire Soggy to abandon his pirating ways and undergo more intellectual pursuits. Metal would inspire Soggy to start a barfight and this would eventually get the both of you thrown out of the bar. While the story content was neat, the scope of the project wouldn't extend far enough to really see the results of this sort of decision. Also, the level that this was designed for was seriously lacking puzzle content so this interaction was replaced with the crowded bar/barfight puzzle that's in the game now.



#### C-Note: The Player's Guide

C-Note doesn't actually have a puzzle associated with him. He comes from a number of puns. A c-note is a slang term for a 100 dollar bill, on which is Ben Franklin. Then there's the more obvious c-note as a musical note.

C-Note's function in the game is to instruct the player on how to play the game. He also gives the player hints when appropriate. When creating the function of this character, we compared him to the *Legend of Zelda: Ocarina of Time* (<http://www.zelda.com/universe/game/ocarinatime/>) character, Navi, who would try to get the player's attention by saying in an incredibly high-pitched voice, "hey, listen!" We parodied this character by having C-Note say in a Barry White low tone, "hey, uh, listen."

## 4.2 World Tiles

Mote levels are constructed with square 53 by 53 pixel tiles. Having tiles of this size gave us a number of tiles displayed on the screen (9x6) that we were comfortable



with. Due to technical constraints with images that are not squares, the tiles themselves are 64 pixels wide and tall, and are simply resized by the game engine.

When choosing a tile size, our initial thought was to make the world tiles and character sprites the same size, and that's eventually what we worked with. However in retrospect, planning out the environment with smaller tiles, such as 32 square pixel tiles, would have allowed for much more flexibility for roughly the same amount of memory used.

Specifying what layers we would need for the levels was another important topic. What we decided on early on is that we would have a layer of background tiles and a layer of foreground tiles which would be arranged together using our level editor. Background tiles appear to be behind characters in the level and foreground tiles appear in front of characters. Having just these two layers suited us fine for the first level, but when we tried more complex areas like the bar in the second level, we began to see the limitations of only two layers. Unfortunately by the time the second level was being assembled it was too late to make such a low-level change in how levels are structured. This, compounded by the relative inflexibility of using square 64 pixel tiles gave us a few headaches. Workarounds were made in the end at the expense of additional textures being made.

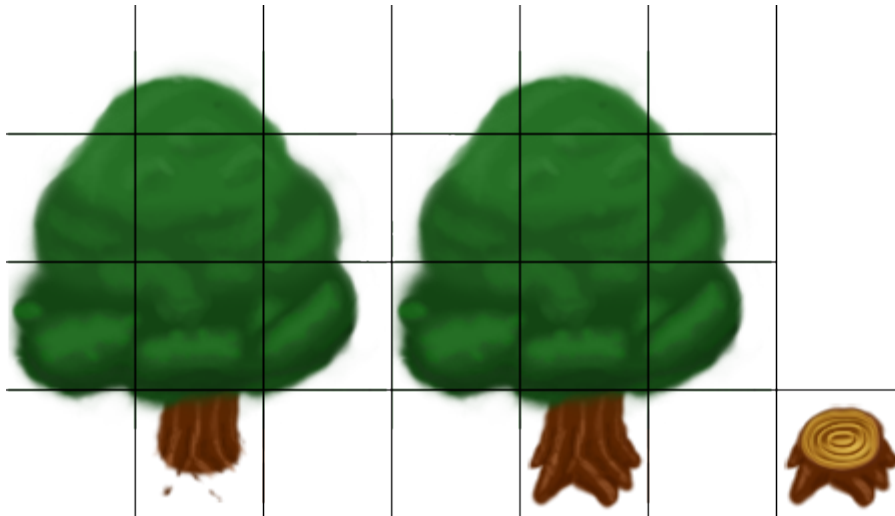

Fig 4.2 Foreground tiles for a tree on the left, the background tile for a stump on the right, and the combination of the two in the middle.

The first tiles we created were simple out of necessity--they consisted of single tile structures that could be used to quickly define shapes of the levels. We began with a blended grass tile made by cross-hatching a few shades of green. Then we moved on to various stumps and rocks that could prove as simple barriers for movement. It became good practice for drawing tiles in the scale of the game, since we didn't have to think about using multiple tiles to achieve proper sizes for objects.

With the single-tile environment pieces complete, we shifted our focus to larger elements, such as trees and forestry. These required a keen sense of scale to create, but more importantly, required knowledge and planning of layers (an aspect of level structure that ended up being particularly restrictive.) A certain structure might require certain tiles to remain on separate layers; in the example of the tree, we wanted Mote to travel behind the branches but not be able to cross the stump. Therefore, we created

foreground tiles that would essentially fit over background tiles that could be used on their own. Fig 4.2 shows how this effect works--we can place the stump separately, or attach the whole top of the tree to it.

Once a number of these larger objects were created, work resumed on more complex tiles that had to blend together. This included pits and rivers, as well as railings and other objects that could be reused and repeated over long areas.

When all of the tiles in the levels were completed, we divided them into 64 by 64 pixel tiles through Adobe Photoshop and imported them into *Mote* using the level editor.

### **4.3 Interface Considerations**

Just as the artistic considerations focused on simplicity for the casual user, each interface was designed with the most minimal, understandable features in mind. After setting a few goals and standards for keeping the touch screen clear and readable, the menus became simple maps that were traceable and simple to understand.

The first interface seen in the game is the title screen. We originally planned for four options: the ability to start a new game, an options menu, and an awards screen that presented you with prizes won through the game.



Fig. 4.3: The early title screen for *Mote* with all options intact. Note the dark edges and blur, as if Moe was drifting to sleep in class.

The idea was to combine fantasy with reality--the buttons would appear dreamy and cartoony amidst a sleepy, realistic background. This would give the player the idea that they would be leaving the waking world behind and slipping into a cartoon dream. This also enabled us to create large, simple buttons with symbolic labels.

As development continued, we realized that there was no need for the options menu, and awards were simply out of the question. The initial realistic view also clashed too much to fit with our graphical style, so the screen was redesigned.



Fig. 4.4: The new title screen. It has a button for credits now and has a more appropriate style.

This new screen has graphics corresponding more with the graphics within the game without being too familiar. The button is less defined, but more stylistic. Considering there is only one button, it was not much of a sacrifice.

The in-game interface is a tad different. Rather than use text, the interaction buttons were all symbolic of their functions. You can progress through pages of text, cancel the interaction with a character, or bring up the keyboard interface. When not interacting with a non-player entity, the pause button simply sits in the lower right-hand corner of the screen, and can bring up a menu that lets you quit the game.



Fig. 4.5: The musical note lets you play a song , and the arrow lets you scroll through text. Tap the X in the corner to cancel.

We wanted to save screen space, so icons are the best possible choice for buttons on this screen. It was essential to show all details of the grounds and environment for the character, and text is space-consuming.

From this screen, you can enter the music interface. Here, you have a keyboard with the option to insert notes and rests. A book sits at the top of the screen to show you available riffs. There is a clear back button, and simple-to-recognize note names and rests.



Fig. 4.6: On the book are printed riffs--once you unlock a musical style, the riff appears on a musical staff with a G-clef.

The idea here was to simulate a simple keyboard and add a rest key. The rest would provide a way to add musical variety to the eight-note riffs. In addition, the eight spots fill up with notes as notes are played, so a player knows how many notes they've played thus far. If the notes form a riff, the menu immediately closes and the player is brought back to the main screen, with the riff playing to the characters. If the notes don't form a riff, the played notes reset and the player can try to form a new riff.

Many of the major, important buttons have pressed states--when your finger touches the button, it "impresses" itself so you know it's reacting to your push. This is important, as a touch screen cannot give a user proper feedback to tell if they're pressing the right thing.



Fig. 4.7: An unpressed button, and how it is impressed when touched by a player's finger.

Upon early testing, the icons were rather difficult to understand, and the riffs within the book were difficult to read. Instructional text has been added as a sort of tutorial, and the riffs were thusly enlarged slightly.

Unfortunately, not all of the interface options were integrated into the final game. The main missing element was a formal "text box" that would have provided a transparent background for the text. This would make the text more organized and much easier to read--however, it may have been impossible to implement due to the three-tiered graphics engine. In addition to this, the riff page was intended to be interactive, and by touching a riff, it would enlarge for easier viewing. Again, this was a bit too technically complicated, and we had other priorities at the moment.

We attempted to include as many user conveniences to allow casual players to learn how to play *Mote* quickly and easily. If the game contained a complicated interface, our goal of a casual game would be lost.

#### **4.4 Music Design**

Music was required to be an essential part of *Mote*--after all, it had been labeled as a "musical adventure game"--and through various means, the musical designs are the end result both sampled and recorded work.

Some of the most important musical assets that had to be created were the riffs that the player could play. These riffs had some special properties to them--because the



interface could only play one octave in a major scale, it was rather difficult to compose in certain styles. Metal, in particular, presented a unique challenge. Our solution was to write the song in A minor (the relative minor of C) to create an angrier tone. The other songs--the classical tune and the pirate shanty--were simple to write in C major and sounded fine. Rap only used one tone and a drumbeat, and therefore only used one note and rests to play.

These songs, along with the ambient sounds used in the forest and pirate ship levels, were created in Ableton Live, a sampling and recording program. While the metal riff was recorded by one of our team members, the other songs were created from samples and loops from Ableton's library.

The title screen music, recorded separately with a guitar and auxiliary percussion, were composed late within the project's life. The goal was to create something simple, catchy, and short. A player would be able to catch the gist of the music from their short stay on the title screen, but would hear a slightly more complex and interesting arrangement as time went on. Rather than Ableton, this piece of music was recorded, equalized, and mixed entirely in Sonar 9, which was available in the home recording studio at which they were recorded.

The song consisted of two guitars and layered percussion that built up tension over time. A tambourine, cowbell, and shaker provided the rhythms to build on the two acoustic guitar parts that were overdubbed to create depth. Before the end of the song,

the mixed percussion and alternating guitar patterns created a complex beat that, while interesting, could be distinctly heard in the style of even the intro.

## 4.5 Sound Effects

Music was not the only audible entity within *Mote*. In order to complete the environment and expand the characters, voice acting and sound effects became an integral part of the game design.

### 4.5.1 Voices

Using Sonar 9 and one SM-58 vocal microphone, voice acting for every character in the game was recorded. This decision came about due to the availability of the equipment and the personal touch of effort it would show within *Mote*. Approximately thirty lines of male voices were recorded for the project by six people, and modified within Sonar 9 and Audacity.

In order to keep voice acting non-essential, yet fun and entertaining, *Mote's* voice-overs feature "gobbledygook" sounds that represent the voice of the character. While you can understand and read the text within the game, the voice acting is actually comprised of nonsense words and syllables spoken in a character's voice. The baby cries nonsense, for example, and the MetalHead spouts angry curses in a haunting tone. Other times, the nonsense forms crude words or attempts to mimic their vocal pattern even more closely. The obese mote wheezes and gasps for air, and nearly passes gas.

The pirates "yar har" and "yo ho" in their own unique personalities, too. If a player listens carefully enough to the hot-tub dwelling pirate, he or she will hear the voice actor mumble, "Hey, baby!"

#### 4.5.2 Environment Sounds

Unfortunately, many of the environmental sound effects came from altering royalty-free sound effects obtained on various websites. Nevertheless, they were modified to great effect. A rushing river became deeper, but less turbulent through some pitch modifications through Audacity. The sounds of doors were lightened to give a bit less of a slamming feel as well.

Originally, Foley artistry was going to be utilized to provide accurate and original sound effects, but a few snafus made this impossible. The main issue with recording many of these sounds was that the recording studio could not be moved. It was not near any sort of running water to create a river sound, and wasn't near a doorway either. While rushing water was eventually recorded, it consisted of a recording of water being poured between porcelain cups--the only material available at the time. Not only did it sound awkward, it couldn't loop well either. Many of the microphones used were also much more suited to picking up the human voice or an instrument rather than an environmental effect. Sonar 9 was also much better suited for instruments and vocals, and did not modify recorded sounds well. Audacity could handle the effects better, but couldn't record at a decent quality rate needed for Foley artistry.

Some sounds used to customize the musical elements of the game were never used within the final version. In early development stages of *Mote*, players had the option of choosing their instrument to play on the musical interface. Therefore, drum rolls, tom rolls, bass drum hits, guitar scales, and bass scales were all recorded. Unfortunately, this fun feature was removed in the interest of time.

## 4.6 Dialogue

The colorful cast of *Mote* would be next to nothing without dialogue--even with their entertaining sound effects and animations, they need to progress the story enough to push the player forward. The dialogue had to fulfill a threefold purpose: develop the world around the player, teach the player how to solve puzzles, and to entertain the player.

Perhaps most obviously, the dialogue had to sincerely represent the non-player characters and the world around them. *Mote*'s dream world is filled with wacky characters found only in dreamscapes, and therefore had to have a lighthearted and representative pattern of speech for characters. The MetalHead screams and shouts angry slang and loves to get riled up, while the Emo Kid speaks in a poetic and faux-mysterious shroud of words. Such stereotypes would be painful to listen to in a real-world setting, but in a dream, they become symbols of emotions or experiences. Perhaps C-Note has the most evocative dialogue in the game--he speaks in a mash-up of old colloquialisms and street slang of the current age. Only in a person's wildest dreams

could they hear something so bizarre. Fitting, then, that he welcomes you into the dream.

However, all dialogue has to instruct the player on their goals, if nothing else. Without dialogue, much of our gameplay would be absent entirely. A player could not hope to know to excite an overweight, hammer-toting Mote without talking to him and realizing he has no energy. Other text serves as an explanation of a barrier. The gruff guard tells you that "None shall pass.", for example. And there is barely a better way to explain the acquisition of a new riff than to have a non-player character explain it to you.

And finally, the dialogue had to keep the player moving. Along with the gorgeous animations and scenery, amusing dialogue should keep the player moving. They will learn that the further points in the game will be subject to the same silliness that exists already. C-Note's insane dialect might leave players in stitches, but they might have an even better reaction to the appearance of the pirate who bathes in a hot tub in level two. Good writing is addictive, and if the players respond well to the dialogue, it becomes a reward for playing.

## 4.7 Level Design

Our first level is a series of rooms arranged vertically. One puzzle needed to be completed in each room in order to progress to the next. The first level needed to be

simple; having the rooms follow a consistent path and requiring one puzzle solve per room helped give us that simplicity.

The first level was created as a collection of puzzles that were then linked together. The puzzles that were put in the level were originally created as a group. These puzzles were then written out by our level designer who also linked the puzzles together and sometimes modified them slightly so they could fit. Occasionally, additional characters were added to help pull the level together.

The first level begins with the player's guide, C-Note, introducing the player to the world and basic controls. In this room, aside from scenery, is the Metalhead character, and a cracked brick wall. The only intractable entity right then is the Metalhead. The only option present is to play the Classical Riff to the Metalhead. Doing so provides the player with the Metal Riff. The next course of action is to play the Metal Riff to the Metalhead. This enrages the Metalhead, who then charges through the brick wall, allowing the player to progress. The remainder of the puzzles in the first level can all be deduced or easily solved through trial-and-error.

Each puzzle in the first level is designed to either demonstrate the purpose of a riff, or to hint at possible branching later on. The first puzzle shows that the Metal Riff enrages. It's not until the second level that much branching actually happens.

The second level begins in a bar. The player must interact with The Dread Pirate Soggy Rumpot and play both the Metal Riff and Classical Riff at different times in order to move through and the crowded bar. On exiting, Soggy brings the player to the ship

and from there the branching happens. There are four different crewmember puzzles to complete before the level is won; except for one of them which supplies the player with the Rap Riff, they can all be completed in any order. The puzzles at this point are still on the easy side. The second level is meant to introduce the player to more complex puzzle styles (two kinds of mazes) and progression structures (the freedom to pick which puzzle to do next.)

## 5 Postmortem

### 5.1 Concept Design

Early on, our team was divided on what sort of game to make. This in itself isn't inherently bad, as differing viewpoints often give a game a nice touch of variety.

However our team lacked an official producer or game designer to say what ideas stay or go. We didn't finalize our concept until three of us had a meeting during Fall Break.

### 5.2 Scope and Team Composition

Our team consisted of three programmers (one of whom is a musician), one visual artist and level designer, and one writer and sound effects artist. Our team also did not have a dedicated producer until the very end of the project. Given our plans, the size of our team, and the amount of time we had to contribute, it's understandable that our game is not as long as we originally hoped.

Our original plan called for a number of things that were both within and outside of the specialties of our team and did not have a realistic timeframe given the number of people we had. Seven levels all containing their own unique tileset, at least five unique characters for each level with a number of animations, interesting and challenging puzzles, and a story to link everything together are just a few things we had planned. In order to make seven levels in fourteen weeks (B and C-Terms) we would have needed at least two tile artists, two character animators, one sound effects artist, one composer, one writer, one game designer, and a producer to coordinate them. All



of them would need to be dedicated to their own roles and not split between two tasks or three tasks as was the case with our artists.

### 5.3 Write From The Beginning

We had a story for our game from the very beginning. Our writer wasn't involved in the story until relatively late and the story suffered because of it.

### 5.4 Layers and Tiles

The decision to make our character sprites, level tiles, and collision walls 64 x 64 pixels in size was made somewhat prematurely. So too was the decision to have only one foreground and one background layer for tiles. Our first level was simple enough for the inflexibility of each to go almost unnoticed. Once the bar and boat for the second level were being planned out, it became apparent how inflexible the standards we had decided on were.

For future projects of similar world design, the characters should be twice the size of world tiles, with the option of having character sprites extend above its own tile. Also there should be at least two background and foreground layers.

With additional layers, the bar could have had a more varied appearance: cutlery, flatware, and containers on tables and counters, objects on the walls, and more flexible chair placement, just to name a few.

Had we been using 32 pixel tiles with 64 pixel characters, we would have much more flexibility with level designs with not much more use of resources.

## 6 Conclusion

*Mote* accomplished more in its development than it will as a finished product. The custom engine for the graphics, sound, and physics is one of just five in existence. If released to the world, the *Mote* engine could help revolutionize the iPhone development community. Our artistic vision was also strong enough to be portfolio-worthy, and I would not be surprised if *Mote* or his friends showed up in another form in a later project.

A few drawbacks held *Mote* back, unfortunately. Recent Terms of Service information from the application store state that external coding, such as Lua, are not permissible within development license terms. There were a few minor programming issues as well, and a few artistic assets were never incorporated into the final version of the game. However, these setbacks do not hold back our development process, as *Mote* is still playable and can be tested further.

If *Mote* were to be continued in a further project, the new team could continue to create assets and possibly improve the gameplay. Our goal of creating an improvisational music game weren't quite fulfilled, but we did create a musical adventure with potential.

# Mote



DC  
Doc Version 3.4

## Contents

1. Quick Intro .....	<b>Error! Bookmark not defined.</b>
2. Vision Statement .....	<b>Error! Bookmark not defined.</b>
4. Five Minutes of Gameplay .....	100
5. Gameplay Elements.....	<b>Error! Bookmark not defined.</b>
5.1. <b>Music Bars, not Health Bars</b> .....	102
5.2. <b>Rock These Riffs</b> .....	102
5.3. <b>Why Am I Here?</b> .....	102
5.4. <b>Musicopedia</b> .....	103
5.5. <b>The Music Is In The Pit, Not On The Stage</b> .....	103
5.6. <b>Notes Of Sand In A Box Of Music</b> .....	104
5.7. <b>You Can't Kill the Metal</b> .....	104
5.8. <b>I Can't Stop This Feelin'</b> .....	104
5.9. <b>You Are Not Alone</b> .....	105
5.10. <b>A Branching Path</b> .....	105
5.11. <b>Woouooooo Shinies!</b> .....	106
Revision History .....	107

## Recent Changes

11/03/2009

Stop... Grammar time

- Minor grammatical changes

# 1. Quick Intro

Mote is a musical adventure game that takes place in a sleeping music student's dream. The player will navigate a surreal landscape and interact with those who dwell within the student's dream.

Mote will use a studio-written engine and will be compatible with any iPod Touch or iPhone.

# 2. Vision Statement

This is a puzzle game in which the player alters the emotions of those he meets in order to progress through the game. This game requires the player to use music to solve puzzles. Players will progress through a surreal world with a number of obstacles and a flowing aesthetic.

The players will play music to solve puzzles. The solves will usually involve affecting the emotions of NPCs with the music. The music used to do this will be very short and based on a wide variety of distinct musical styles. Among them are Classical, Jazz, Rock, and Pirate Shanty.

### 3. Quick and Dirty Feature List

- Music influences a variety of things in the environment including the color of the background and the moods of the NPCs.
- Knowledge of Music Theory is **not necessary**.
- Easily accessible references will be provided for all gameplay elements.
- The background music and environment will change dramatically from one level to the next.
- The player is free to do whatever he wants without permanent consequences.
- Optional multiplayer allows people to see others' progress in the game.
- Certain achievements within the game will be viewable by other players and will trigger contextual bonus content.

#### 4.1 Five Minutes of Gameplay

You move your finger in a line. Mote moves in that direction.

The background music is calm and cheerful. In the background of the scene, more lights pulse along with the background music.

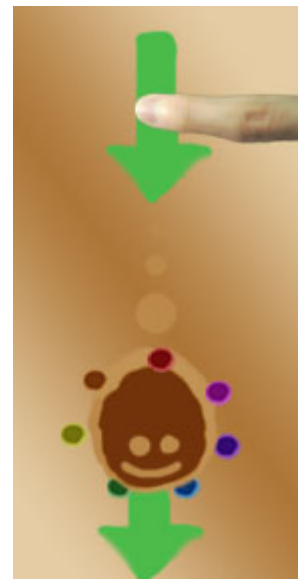





You float by a bar. The sounds of a loud crowd emanate from inside.

You enter the bar. Behind the crowd of patrons and toward the back of the bar is the violent Dread Pirate Soggy Rumpot. He has two eye patches, a pirate hat, and a scraggly beard.

You talk to him by tapping on him. He tells you about how he lost his eye, and his other eye, but he doesn't want you to ask about his hat. He doesn't like to talk about his hat.

After the dialogue, a menu appears that gives you the option to play music. You choose to play. A musical staff appears with a list of notes at the bottom. Among them are riffs representing blues, classical, and metal.

To play the riff of a certain style, you must tap on the notes at the bottom of the screen in the correct order. Depending on which you play, one of these three will happen:

1. If you play the riff for blues, the music makes him tear up. He then tells a sad story about a young lass who once broke his heart... so he keelhauled her.
2. If you play Metal, the music will enrage him, causing him to start a bar fight and completely wreck the bar. The two of you are then thrown out by the bartender.

3. Playing Classical will inspire him to abandon piracy and violence and seek more intellectual pursuits. He'll leave the bar to study on his boat.

After Soggy leaves the bar, however that happens, he will let you on his boat.

On the boat, Soggy is eager to set sail, but his crew is a bunch of lazy landlubbers. Your next task is to motivate them to get the ship ready to sail.

## 4. Gameplay Elements

### 5.1. **Music Bars, not Health Bars**

There won't be hit points in this game; no character statistics either. It's all based on what the player does and what the player character can do.

### 5.2. **Rock These Riffs**

You will have a number of eight beat "riffs" to play. The riff played is what determines the effect on the person you're interacting with. There will be a number of riffs throughout the game that the player can collect and discover through fulfilling goals and experimentation.

The Musicopedia keeps track of the riffs the player has discovered.

### 5.3. **Why Am I Here?**

The player, as Mote, must collect musical concepts as physical items, which are at the end of each level. As Mote

gathers these objects, Moe, the dreaming visual art student, learns the corresponding concepts in the real world. This enables Moe to pass his music class.

During the course of the semester, different events happen in the real world that impact Moe's dreams.

## 5.4. Musicopedia

Our pause menu will be a "music book" of sorts that will also serve as a reference and a tool. It'll be limited to information on musical styles that are currently relevant (what the player has seen so far), a journal section, a list of achievements, and a list of currently known riffs that the player can use to solve puzzles.

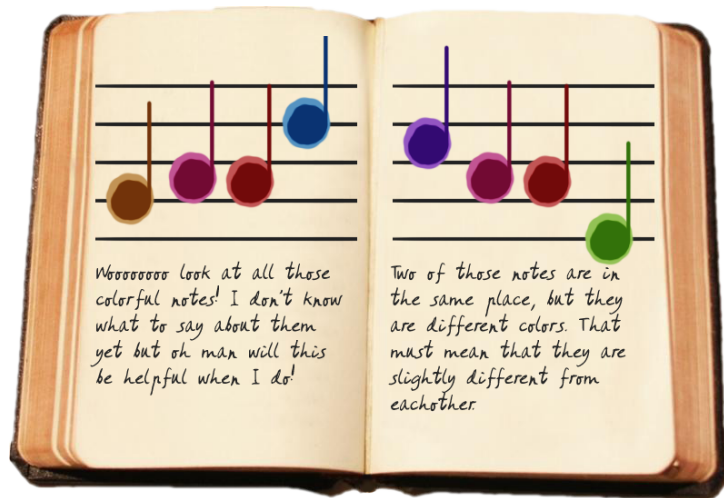

## 5.5. The Music Is In The Pit, Not On The Stage

The options players have will be related to music theory, but the structure of the interface will be made so that the player doesn't have to think about the music theory if they choose not to.

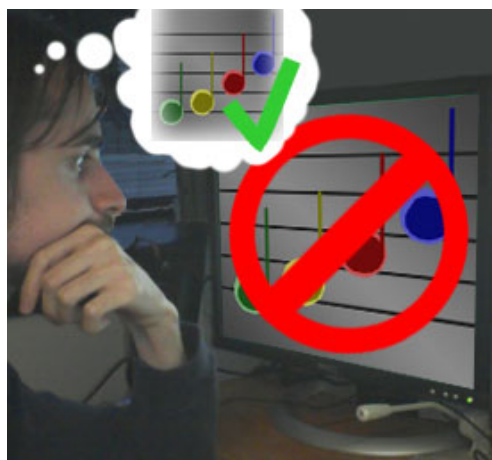

## **5.6. Notes Of Sand In A Box Of Music**

The player will have a set number of musical styles to choose from. When the player plays a riff, a short premade accompaniment will play that fits that style. What determines the outcome of playing music is the riff which was played.

The Musicopedia keeps track of the riffs the player has discovered and knows what can be played.

Some unnecessary puzzles and achievements can be gained by playing riffs or notes that don't ever appear in the book.

## **5.7. You Can't Kill the Metal**

Dying isn't fun, so we're not going to have that here. The worst that can happen is the player gets knocked out of an area and needs to start that puzzle segment over.

## **5.8. I Can't Stop This Feelin'**

The riff being played will affect the NPCs and the environment. For example, if the player plays loud metal, you will scare small children. If you play dance music, you will inspire people to dance.

## 5.9. **You Are Not Alone**

This game will have a very minor multiplayer component. You can play through the game by yourself or you can choose to see people near you. If you choose to see people near you, your game will synchronize with theirs and they will appear in the game as ghosts. Seeing the other person doesn't actually influence gameplay. The multiplayer connection itself will be over Bluetooth, so anyone else you see in the game will probably be in the same room.

## 5.10. **A Branching Path**

There's more to the game's progression than just the path to the end of the level. There are side paths (which are optional) that challenge the player in a new way and allow the player to further augment Mote's collection of riffs and achievements. Although these paths all lead to some reward, none of them are explicitly necessary to solve the puzzles which lead to the end of each level.

## 5.11. Woooooo Shinies!

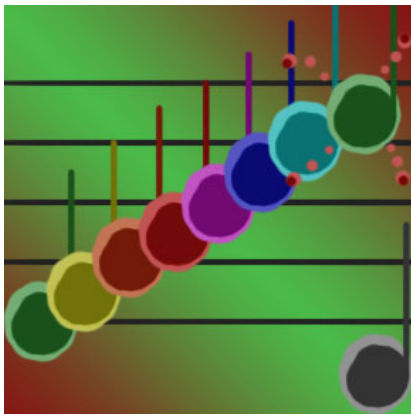

Anything and everything will have some sort of visual and/or audible feedback. If the player does a good thing, bright colors and a clear sound relevant to the action will help indicate that the puzzle was solved. If the puzzle is not solved, something amusing still happens and the player is alerted in some way that the path is

not open.

Achievements were mentioned a number of times earlier in this document. We're going to have a bunch of them. Some of them the player can achieve multiple times. One example of an achievement is playing part of a famous song, like the first bit of Beethoven's Ode to Joy. A speed run of a level could be another. Anything notable (or not-notable) will have an achievement associated with it. These achievements will be viewable by others and will contribute towards your music class grade (D to A+.)

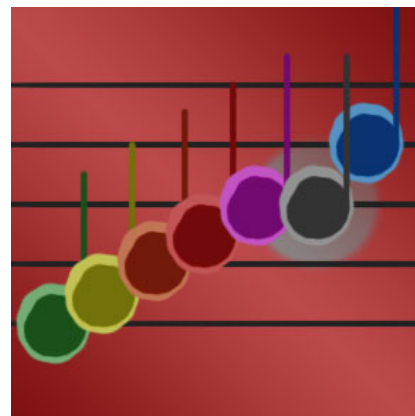

## Revision History

0.8 – Doc created 9/14/09

1.2 – Second draft 9/21/09

- Rearranged sections
- Put TOC on it's own page
- Minor wording changes
- IMAGES IMAGES IMAGES EVERYWHERE!!!
- Augmented “Wooo Shinies!” section
- Added 5m of gameplay section (no images yet) D:

2.0 – Third Draft 9/21/09

- Revised Quick Intro
- Revised Vision Statement
- Dispersed Music In The Pit section
- Augmented Quick an Dirty Feature List
- Renamed and Split “The Beat of Battle”
- Added “Musicopedia”
- Added Title Page

2.4 – Old Mote Final Draft

- Changed wording of “battles” to “music battle”
- Revised “Quick Intro”
- Augmented “Quick n’ Dirty Feature List”
- Added “You Are Not Alone”
- Added “Rock These Riffs”
- Added “A Branching Path”
- Added section numbers
- Added page numbers
- Added version number and author
- Achievements now less “meta”
- Added images to multiple sections

2.8 – New Concept

- Rewrote most sections

3.0 – New Mote 1 Final Draft

- Many grammatical clarifications
- Updated Floating Through a Dream
- Minor Image changes.

### 3.4 – Another new concept~

- Updated Feature List
- Augmented Floating Through a Dream section
- Changed most sections
- Added more sections



Technical Design



## Table of Contents

<b>CODING STANDARDS .....</b>	<b>111</b>
PURPOSE.....	111
UML DIAGRAMS .....	111
CODE FILE COMMENTS.....	111
CAMEL CASE .....	112
OPENING METHOD BRACKETS.....	112
COMMENTS .....	112
UNIT TESTS.....	114
MEMORY MANAGEMENT.....	114
<b>FILE DESIGN STANDARDS .....</b>	<b>115</b>
LEVEL FILES.....	115
SPRITE & SPRITE SHEET IMAGE FORMAT.....	116
<b>GRAPHICS SYSTEM .....</b>	<b>117</b>
<b>UTILITIES.....</b>	<b>117</b>
<b>INPUT HANDLING.....</b>	<b>118</b>
<b>SOUNDS .....</b>	<b>118</b>
<b>GAME STRUCTURE AND UTILITIES .....</b>	<b>119</b>
<b>PHYSICS .....</b>	<b>120</b>
<b>NETWORKING .....</b>	<b>121</b>

## Coding Standards

### Purpose

The purpose of coding standards is to facilitate the interpretation, debugging and adaptation of code between multiple developers. Having concrete pre-determined coding style rules promotes consistency and clarity throughout the project.

### UML Diagrams

Every aspect of the system will be constructed in both class and package diagrams before the systems will be constructed. These diagrams will facilitate the understanding of the system as a whole, as well as reveal potential design flaws early in the development process.

### Code File Comments

All classes will have their own header (.h) and implementation (.m) files. Each file will have a comment in the beginning of the file (xcode generates most of this automatically) which will contain the name of the file, the author, and the date created.

Example:

```
//  
// Timer.h  
// iPhoneMusicGame  
//  
// Created by Graham Pentheny on 9/9/09.  
// Copyright 2009 Worcester Polytechnic Institute. All rights  
reserved.  
//
```

## Camel Case

All variable and method names will use “camel case.” Names start with a lowercase letter. If the name has more than one word, (for example “the unit grid”) the first letter of each subsequent word will be uppercase (e.g. “theUnitGrid” or “getTheUnitGrid()”). Names with underscores or hyphens will not be used in this project.

## Opening Method Brackets

All opening code block curly brackets will be on the line immediately following the code block definition.

For example:

```
for (int i = 0; i < timesToLoop; i++)
{
    //code here...
}
```

## Comments

Code comments are essential to creating extensible, maintainable systems. Proper commenting style and will be stressed in this project.

We will be using a JavaDoc-style commenting scheme, as it is well known by each of the developers, and is a proven method for describing the behavior of a class or method. Class and method comments (those that precede and describe a specific method or class) will be placed in the .h header file only, whereas inline comments with the purpose of clarifying implementation details will be placed in the .m file along with the code they describe.

All classes will have a comment that precedes the “@interface” declaration, begins with a slash and two asterisks, and describes the purpose and role of the class. It will also contain an “@author” declaration preceding the name of the creator of the class. Additional information describing the role of the class or the part of the engine it is provided for will be added at the designer’s discretion. For example:

```
/**
 * Timer handles timing specific actions and events.
 *
 * @author Graham Pentheny
 */
@interface Timer : NSObject {...
```

Method comments will be formatted in an identical fashion to the class comments, although they will have some added notation to describe the behavior of that class. If a class takes parameters, each will be described in the method comment. Each parameter will have an “@param” statement, followed by the parameter name, followed by a short description of the parameter. If the method returns a value, it will be described after a “@return” tag.

```
/**
 * Adds two vectors and returns the result.
 *
 * @author Graham Pentheny
 *
 * @param vector1 One of the two vectors being added together
 * @param vector2 The other of the two vectors being added
 *                  together
 * @return a pointer to a vector containing the sum of the two
 *         vectors.
 */
+ (Vector3f *)addVector:(Vector3f *)vector1 withVector:(Vector3f *)
vector2;
```

## Unit Tests

A strict unit testing regiment will aid greatly in distinguishing between design flaws and implementation bugs. Unit tests will be created for every class implemented in the system. They will follow the standard Objective-C style unit test template. Wherever possible, we will strive for 100% code coverage.

## Memory Management

Memory management is important in creating a stable and responsive application on the iPhone. The limited resources of the iPhone amplify the need to eliminate memory leaks and use memory as efficiently as possible. We will tend to use more time-intensive algorithms in place of more space-intensive ones, as excessive memory usage is a common reason for application crashes on the iPhone.

Apple's suggested strategies for memory management will be adhered to as closely as possible. All instance variables in both classes and methods will be released at the end of their scope or set to auto-release. The `-(void)dealloc` method will be implemented for all custom classes, releasing all instance variables of that class.

## File Design Standards

### Level Files

Every level in the game will be stored as a grid of cells (a terrain map), with each cell holding information about the terrain that occupies it. The information that the cell holds will be:

- Whether or not an NPC starts the level in this cell, and the NPC ID (what NPC it is)
- The Tile ID. For example:
  - The player start position
  - Doors
  - Triggers
    - Holes
    - Warp Zones
    - Cut-scene activation
  - Things that can be interacted with
    - Switches/levers
- Whether or not the cell can be occupied by the player
- The foreground texture for that cell
  - Will appear in front of the player if the player is north of it.

Each cell in the grid translates to an area of 53x53 pixels in game. Thus, if the level grid is 24x24 cells, the actual level will be 1272x1272 pixels (24 cells \* 53 pixels/cell = 1272 pixels).

There will be three “render layers” for a level. Each “render layer” will contain textures that are to be overlaid upon the previous levels. The bottom layer will be the background texture. This layer will only contain static sprites and images. The second layer will contain all NPC’s and player avatars. All sprites in this level will be animated. The third and final layer will contain static foreground sprites that may be overlaid on any NPC’s or player avatars.

Because of this level structure, we will store every level externally as a 16-bit bitmap image (.bmp). Each pixel of the image will represent one cell, and the colors of the pixels will determine the information mentioned above. The information will be stored as follows:

- Red component: The background Tile ID. Describes what texture the background tile is.
- Green component: The foreground Tile ID. Describes what ID the foreground tile texture is, if any.
- Blue component: A 0 if the tile is impassible, a 1 if the tile is passable but empty, and the entity ID of the NPC occupying that cell if it is passable but occupied.

The final rendered pixels for a given cell are overlaid using the painter's method. The background texture is first, followed by any NPC or player sprite, followed by the foreground tile if any.

### Sprite & Sprite Sheet Image Format

Sprites will be stored as PVRTC image files. The iPhone has a hardware-implemented PVRTC decoder, and Apple suggests that this format be used to maximize performance when dealing with texture data. PVRTC images have some loss of quality compared to raw image formats (eg. .bmp or .tiff), but take up significantly less space, and support transparency. For animated sprites, the individual frames will be stored in one large PVRTC sprite sheet image (all horizontally), and will be split up for animation at run-time.

One "entity" (the player, an NPC, etc) may have several different animation sprite sheets. For that, we will create a file for that entity that holds meta information for its sprites, such as a list of all its possible sprites (both animated and



non), the width and height of its different sprites, the sprite origins (offset from the upper-left corner), and the speed of its animation. This is also advantageous if the data for a sprite needs to change: the entire project does not need to be re-compiled, only the entity file needs to be modified.

## Graphics System

The game will feature a two-dimensional “three quarters” top-down view, similar to the Pokémon series’ view perspective. The implementation will consist of a camera looking directly at a series of parallel quads with textures (the “cells” mentioned above). The view vector of the camera will be perpendicular to the quads, and thus be the opposite of their normal vectors. The perspective projection will be orthogonal and the illusion of depth will be “baked-into” the art assets.

The game world will be divided into an evenly spaced grid. Each element of the world, and its art asset, will comprise a discrete and complete number of grid squares. The player may move their character in the standard north, south, east, and west directions, as well as diagonally northeast, northwest, southeast and southwest.

## Utilities

This section of the engine will contain data structures that are not built into Cocoa. We will need structures that do the following in our code:

- A structure to hold a level in memory once it has been loaded

- A structure to hold saved progress and record it when the player exits the game
- A structure to hold NPC's within the game, including their animations and reactions
- A structure that stores the direction of the player's movement to be processed by the physics engine.
- A structure that holds the modifications to the player's sprite that the player makes.

## Input Handling

The input handling system will translate user inputs (swipes, pinches, taps, etc...) into game events and actions. Dynamic registration and management of input callback methods will be supported.

Menu navigation will be done with just taps, with the possibility of a few long tables that must be scrolled through.

While in the game, movement will be done by swiping in the direction of movement, so we will need to determine which direction the swipe went in, and approximate that to a direction of movement. We will have an object that stores the direction of movement to be read by other sections of the engine.

## Sounds

Sounds and music will be a key element in our game. Accurate and precise sound playback will create a usable and responsive music system. The player will play music to other characters in the game to influence their actions in ways that are beneficial to the player. The player will choose a musical genre to play from a set of genres the player's avatar has accumulated. Each genre will have one or more

"lead" instruments associated with it. For example, the metal genre will have a guitar as the "lead" instrument. A simple interface for playing musical notes will appear. The player will play a specific series of 8 notes, called a "riff". If the riff played corresponds to a musical genre, that genre is played along with an accompanying animation.

Each genre will have one or more tracks that will embody the player's lead instrument. These will be pre-composed and pre-recorded tracks which will be played back through the iPhone's built-in hardware-decoded ima4 playback. Per recommendation by the Apple iPhone development documentation, the musical tracks will use the ima4 codec to minimize the amount of CPU required for playback.

## **Game Structure and Utilities**

We will have a class for the player, and a class for NPC's. The player class will contain everything that is needed in a save game file, to facilitate ease of storage. This includes the level the player is currently on, the player's position in the level, the types of music the player can play, and the achievements that the player currently has. The player class will need to be able to handle player movement, although the physics engine will handle locomotion. The player class will also hold information about how the player looks, so the player can customize how they look.

The NPC's will need to have their animations, an identifier that describes which NPC it is, and a link to any sounds that they make when interacted with. They

also need to be able to tell the game what they are doing when they interact with the level.

## Physics

Physics in the game will be minimal. There will be collision detection between the player and the terrain, but it will not involve force or momentum or anything like that; it will simply not allow a player to enter an occupied or restricted cell. There may be some virtual "elasticity" between two entities (similar to collision between two characters in Super Smash Brothers) so they cannot occupy the same space.

The level's grid structure will make collision detection very simple and fast to process. Because the terrain is divided into cells (which are either "able to be occupied" or "not able to be occupied"), the system only needs to determine if the player is able to occupy the cell they are trying to move into. Not only does this cut down processing time significantly, but it also makes level design much simpler.

There may be a particle system in the game for actions that happen as a result of the player playing music, and those particle effects would follow the laws of physics. Again, however, it would be very minimal, and probably not encompass more than gravity and a force toward a particular object.

## Networking

The iPhone facilitates ad-hoc Bluetooth networking, as well as traditional Wifi networking. We will incorporate a minor multi-player aspect. Players will be able to play “with” nearby players. The nearby player positions will be viewable as “ghosts” of their avatars. This component will use the iPhone and iPod Touch’s ad-hoc Bluetooth networking feature.

All objects and actions will be serialized in a proprietary format that will be decoded and translated into events and messages by the other device.

## Appendix C: Summary of Research into Similar Games

- **World of Tunes:** World of Tunes shows a distinctive style, but doesn't offer much in terms of gameplay. It has a lot of character and maintains a fun atmosphere.  
<http://global.com2us.com/game/wot>
- **Rock Band Unplugged:** To play, you tap notes in time with the music and switch between instruments to balance them out. While there's barely any interaction other than that, the "multiple instruments" gimmick" was something to look at.  
<http://www.rockband.com/games/unplugged>
- **Meteos:** Launch pieces by matching them to destroy planets. Music and players change every level. When pieces are launched, music snippets are played. As the pile of pieces builds up, the music gets more frantic and urgent.  
<http://planetmeteos.com/>
- **Final Fantasy XII:** Combat is done on the main map, and when combat starts, the main world doesn't stop.  
<http://www.finalfantasyxii.com/>
- **Shadow of the Colossus:** Music starts out foreboding, but becomes triumphant as you attack each boss that appears.  
[http://us.playstation.com/ps2/games/shadow\\_of\\_the\\_colossus/ogs/](http://us.playstation.com/ps2/games/shadow_of_the_colossus/ogs/)
- **Osu:** A rhythm game where you tap the screen in time with buttons and music. Finger gets in the way a lot. Failure causes the on-screen guide to yell at you.  
<http://osu.ppy.sh/p/iphone>

- **E.V.E. Online:** In battles, people usually orbit each other. This could potentially be synced to beats within our game.  
<http://www.eveonline.com/>
- **Music Piano Reading:** Tries to teach music, but ultimately fails. It is a quiz with no teaching involved.  
<http://itunes.apple.com/us/app/piano-music-reading-free/id317541102?mt=8>
- **Achievement Unlocked:** A game about getting achievements. Getting achievements is typically good, but most of the ones in this game are meaningless and wastes of time. Having achievements that grant new abilities is good, but the new abilities should be nonessential.  
<http://www.kongregate.com/games/ArmorGames/upgrade-complete>
- **Music Catch 2:** Catch music notes in time with music. Collecting stuff is fun, but it should do more than just give a high score.  
<http://www.kongregate.com/games/Reflexive/music-catch-2>
- **Synthpond:** Nodes in a pond generate waves, which are translated into sound. Synthpond uses a spatial sequencer instead of a play head. Round nodes generate waves to a beat and square ones generate waves when hit by round node waves. Uses spatial sound, so music directional. This is not a game. The interface is pretty cool. Most music made with this toy sounds good.  
<http://apps.stfj.net/synthPond/>
- **WiiMusic:** "Improv Mode" lets you make your own music. Since it uses WiiMotes, it doesn't feel like actually playing an instrument.  
<http://www.wiimusic.com/>

- **PyroSand:** No goal or win condition, just play around with pixilated sand.  
<http://fallingsandgame.com/sand/pyro.html>
- **DJ Mix Tour:** This game is a DDR clone, but provides a context for random button tapping. Instead of just buttons on a line, a player would scratch discs and mess with the middle bar. It makes players feel more like DJs.  
<http://itunes.apple.com/us/app/dj-mix-tour/id317796239?mt=8>
- **Boxed In:** You guide a character by touching the screen, but it doesn't matter where your finger is. This helps prevent a thumb from blocking the screen.  
<http://www.boxedgame.com/>
- **Rhythm Fireworks:** This is another DDR clone, but you need to have your line be the right color to actually get the note right. It combines visual and sonic aesthetics.  
[http://www.kongregate.com/games/Coolio\\_Niato/rhythm-fireworks](http://www.kongregate.com/games/Coolio_Niato/rhythm-fireworks)



## Appendix D: Mary Yovina's Animations

Mote:



Babby the Baby:



The Bandit:



Emo Kid:



The Guard:



Lost Pirate:



Mr. Hammer



Pirates:





Sleepy Guy:

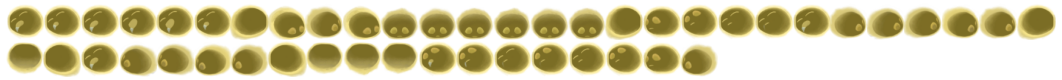

Captain Soggy Rumpot:



The Metalhead



Other Assorted Animations

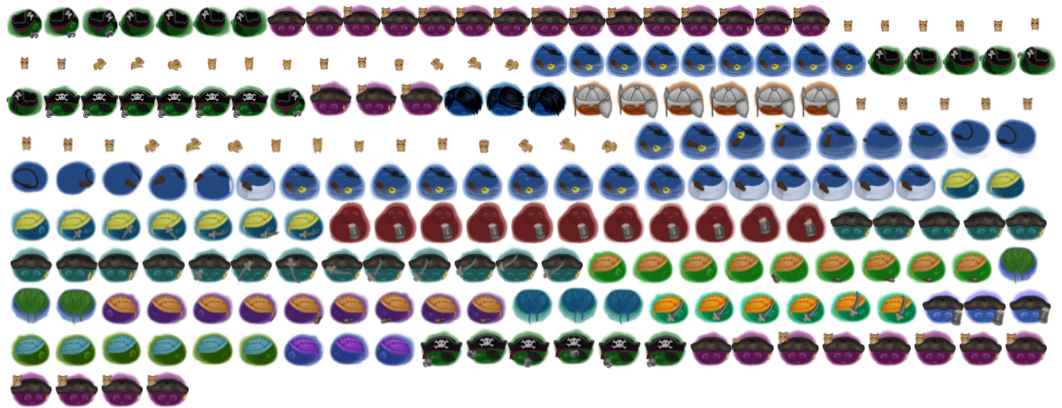

Uncut Animations

