

# STEM Education Activities for Science Bootcamps

The Commonwealth Scientific and Industrial Research  
Organisation

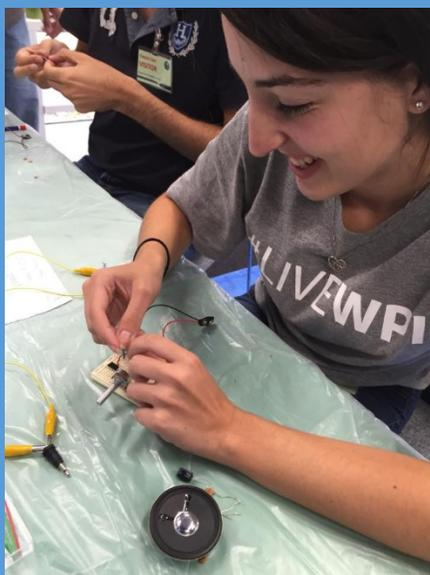

14 December 2015

By:

Rachel Connolly

Adam Gatehouse

George Karapanagos

Matthew Portugal

Paul Davis, Dave Szkutak, and Joan Szkutak

IQP Advisors

Chris Krishna-Pillay and Carly Siebentritt

CSIRO Liaisons



# Abstract

Australia's Commonwealth Scientific and Industrial Research Organisation runs Science Bootcamps to motivate secondary students to pursue studies in science, technology, engineering, and mathematics, a need critical to many industrialized nations. We completely developed two activities that will be offered in 2016 Bootcamps: constructing a phone speaker and using magnets to clean oil spills. We based these activities and a guide for future development upon interviews with experts, focus groups with educators, and surveys of participants in previous Bootcamps.

# Acknowledgements

Our time in Australia has been incredible and was worth the thousands of kilometers we travelled to get here. There are many people we would like to thank for helping us with our project and allowing us to enjoy our time in Melbourne.

We would first like to thank our advisors, Paul Davis, Dave Szkutak, and Joan Szkutak, for directing us, and the other project teams, through the long and winding path that was our project. Thank you for all of the suggestions, corrections, advice, and input which allowed us to develop a better project.

We would like to thank Professor Melissa Belz, our ID 2050 instructor, for preparing us for our time in Australia and for the pizza you got us at several mandatory ID 2050 events.

Cheers to everyone over at CSIRO Education and Outreach for making us feel welcome in the office. We hope you all enjoy the new facility you work at. Thank you to all the staff who were kind enough to sit down for interviews with us, especially to those of you who had to deal with us for both interviews. The information we got from those interviews was very insightful and helped us greatly with our project. Thanks to the staff members who played lunch time trivia from the newspaper with us. Someone definitely needs to call the editor of that section and let them know about those wrong answers. Thanks to Sally for always bringing us unexpected food! Special thanks to Carly for driving us to Jaycar numerous times to get supplies we needed for our speaker and for 3D printing many versions of the case. Another special thanks to Ava for organizing those intense escape rooms for the office's Christmas celebration. Somehow we all made it out of those rooms alive.

Thank you to Elke, Sarah, and our peers for pilot testing our Bootcamp activities. We really appreciated the help and fresh sets of eyes on the activities and supporting content. We

also appreciated the offer (bribe) of food and beverages to our peers by Chris in an attempt to motivate our peers to help us.

Thank you to everyone who contributed to our project and helped us make it an incredible experience.

# Executive Summary

The Commonwealth Scientific and Industrial Research Organisation (CSIRO) is Australia's national science agency that performs research to solve global issues. In addition, CSIRO's Education and Outreach (CEdO) department organizes several educational events throughout the year, including public seminars, holiday science camps, and award programs. The most recent addition to CEdO's program, started in January 2015, is Science Bootcamp, which is a two-day educational program aimed at students ages 13 to 18 years old. During the program, students participate in engaging science activities, visit CSIRO's research facilities, and meet CSIRO researchers. Bootcamp aims to motivate students to consider future careers in one of the Science, Technology, Engineering, and Mathematics (STEM) fields.

STEM fields have greatly contributed to the advancement of many countries throughout the world over the last century. Despite the growing number of STEM occupations, student interest in STEM education is declining (Kennedy, Lyons, & Quinn, 2012). Australia's Federal Government recognizes that Australian students are lagging behind students in other countries and is developing a plan to improve Australia's quality of STEM education and knowledge (Office of the Chief Scientist, 2013). One of CSIRO's objectives is to support the Government's efforts to increase student interest in STEM through their Science Bootcamp Program.

## **Our Goal**

Our goal for this project was to develop new engaging and educational hands-on activities that will be offered in 2016 Science Bootcamps and to provide CSIRO with a guide for future activity development. To reach this goal, we completed four objectives:

### **1. Identified criteria of successful activities**

To ensure the effectiveness of our activities, we identified design principles to engage students in the activity and to motivate them to consider a future in one of the STEM fields. To identify design principles, we performed literature research and interviewed Worcester Polytechnic Institute (WPI) professors who ran STEM education programs in the past summers. We confirmed the design principles for Bootcamp met CSIRO's expectations by interviewing CSIRO education specialists.

### **2. Evaluated and assessed our selected list of potential activities based on our identified criteria and criteria provided by CSIRO**

The extracted design principles from Objective 1 together with safety, cost, timing, and interest level were used to assess our list of potential activities. Safety, cost, and timing requirements were set by CSIRO. Interest level was determined with a Facebook survey of our WPI peers and analysis of surveys completed by participants of previous Bootcamps. Application of these criteria resulted in a shortened list of activities.

### **3. Fully developed the chosen activities through personal assessment**

To determine which activities on our shortened list to fully develop, we conducted further interviews with CSIRO education specialists. Two activities, the phone speaker and the magnetic putty and ferrofluid activity, and all material needed to run the activities were developed based on personal assessment and peer review. Three partially developed activities were also created: the electrocardiogram (ECG), the digital clock, and the 3D printed bridge competition.

#### **4. Pilot tested and refined the developed activities**

The two fully developed activities were thoroughly pilot tested with CSIRO education specialists and our peers. The pilot test confirmed that the activities would be effective in Bootcamps once the timing and schedule were adjusted.

#### **Recommendations**

Executing these objectives resulted in completely developing two activities and a guide for future development of activities. As a result, we provide recommendations in the following areas:

- Design Principles in STEM Activities
- Interest of Bootcamp Students
- Bootcamp Activity Appeal to Females
- Developed Bootcamp Activities
- Development-Stage Considerations

#### Design Principles in STEM Activities

We determined six design principles that should be implemented for successful Bootcamp activities. These design principles are listed below and should be implemented in the following ways:

- **Real world relation:** Using analogies or metaphors, visually demonstrating a concept, sharing a surprising fact or connecting the subject to research can achieve a real world relation.
- **Take-home item:** Students should create the take-home item themselves, because their creation will more effectively remind them of their accomplishments during the activity.
- **Student success:** STEM activities should offer variations of each task, resulting in a range of difficulty levels such that all students will feel successful.
- **Challenging aspect:** STEM activities should be structured in a way that challenge students by having an open-ended objective, but also give students enough resources to achieve the objective. Additional helpful material should be available for students who are struggling to overcome a challenging task.

- **Group work:** STEM activities should incorporate a mix of individual and group activities. When working on a hands-on task, the optimal size of a group is between 3 and 5 students. When learning background theory, students should be paired up to encourage discussion and to encourage shy students to voice their opinion.
- **Design step and build step:** STEM activities should include both a design step and a build step. The design step should be prior to the build and the two should be closely related. Students get more engaged and involved in building something that they designed themselves.

### Interest of Bootcamp Students

The activities that were found to be the most promising based on student interest were the 3D printed quadcopter, 3D printed bridge, magnetic putty and ferrofluid, phone speaker, and ECG. **We recommend that CSIRO continues to improve upon the understanding of student interest through use of a more structured post-Bootcamp survey.**

### Bootcamp Activity Appeal to Females

During our interest level investigation, we determined that biology and chemistry are the two most popular subjects to females. We confirmed our finding through background research and identified that the reason for this preference is that these two subjects present a clear connection to a positive social impact. **Bootcamp should implement activities relating to biology or chemistry and activities closely related to making a positive social impact in order to attract the underrepresented female audience.**

### Developed Bootcamp Activities

The phone speaker and the magnetic putty and ferrofluid activities were completely developed and pilot tested. We finalized the two activities by adjusting the time and schedule according to the pilot test results. The phone speaker activity has been chosen for 2016



Bootcamp and we recommend the magnetic putty and ferrofluid activity be implemented for an additional 2016 Bootcamp.

#### Development-Stage Considerations

Based on our experience developing the activities and the pilot tests, we identified six suggestions to aid with developing future activities. **The following should be considered when developing a Bootcamp activity:**

- Safety is the number one priority.
- New material should be presented but not in a way that requires too little or too much time
- Necessary background knowledge should be provided to students before beginning the hands-on part of the activity but should be kept to a minimum.
- Instructor lecturing should be kept to a minimum and should be presented in an interactive manner.
- The optimal way to begin an activity is by establishing an emotional connection.
- Pilot testing an activity is an essential step to producing a successful and time-effective activity.

#### **Conclusion**

By delivering our project goal, we were able to completely develop two engaging and motivational activities to be used in CSIRO's Science Bootcamp. The phone speaker has already been chosen for the January 2016 Bootcamp and our team suggested that the magnet activity be considered for use in a subsequent 2016 Bootcamp. In addition, based on the knowledge gathered through the development process we developed a thorough guide for CSIRO on how to create more activities for Bootcamp in the future.

# Authorship

	Primary Writer	Secondary Writer	Primary Editor	Final Editor
Acknowledgements	Adam	-	Rachel	All
Executive Summary	George	Rachel	Matt	All
1. Introduction	All	-	-	All
2.1 STEM Education	Adam	Rachel	Adam	All
2.1.1 Need for a STEM Educated Population is Growing While Student Interest is Declining	Adam	Rachel	Adam	All
2.2 Experiential Learning to Motivate STEM Careers	Rachel	George	Adam	All
2.2.1 Motivation in STEM Programs	George	-	Rachel	All
2.2.2 Expectation of Success and productive Failure in STEM Programs	George	-	Rachel	All
2.2.3 Subjective Task Values in STEM Programs	George	-	Rachel	All
2.2.4 Differences in Motivation due to Socioeconomic Status and Gender	Rachel	-	George	All
2.3 Characteristics of Successful STEM Programs	Matt	Rachel	Matt	All
2.3.1 STEM Education Bootcamp for Teachers	Matt	Rachel	Matt	All
2.3.2 Worcester Polytechnic Institute (WPI) Frontiers Programs	Matt	Rachel	Matt	All
2.3.3 American Chemical Society (ACS) Project SEED	Matt	Rachel	Matt	All
2.3.4 Gateway STEM Schools	Matt	Rachel	Matt	All
2.3.5 Design Principles of Experiential Learning Programs	Matt	Rachel	Matt	All
2.4 The Work of CSIRO	George	-	Rachel	All
2.4.1 CSIRO Education Programs	George	-	Rachel	All
2.4.2 Bootcamp Overview	George	-	Rachel	All
2.4.3 Project Overview	George	-	Rachel	All
3. Methodology Chapter	Rachel	George	Adam	All
3.1 Objective 1: Identify Criteria of Successful Activities	Rachel	George	Adam	All
3.1.1 Interviews with STEM Educators at WPI	Rachel	George	Adam	All
3.1.2 Interviews with CSIRO Education Specialists to Confirm Design Principles	Rachel	George	Adam	All

3.2 Objective 2: Evaluate and Assess Each Activity on our Selected List of Potential Activities Based on Given and Developed Criteria	Adam	Rachel	Adam	All
3.2.1 Assessment of the Primary Criteria, Viability, and Design Principle Implementation	Adam	Rachel	Adam	All
3.2.2 Evaluation of Activity Interest Level using a Focus Group and Survey	Adam	Rachel	Adam	All
3.3 Objective 3: Fully Develop the Chosen Activities	George	Rachel	Matt	All
3.3.1 Interview Experienced STEM Instructors to Determine Potential Challenges	George	Rachel	Matt	All
3.3.2 Personal Assessment through Multiple Test Runs of the Activities	George	Rachel	Matt	All
3.3.3 Peer Review of Developed Written Material	George	Rachel	Matt	All
3.4 Objective 4: Pilot Test and Refine the Developed Activities and Determine which Design Principles Maximize Effectiveness, Engagement, and Learning	Matt	Rachel	Matt	All
3.4.1 Test and Gain Feedback on the Developed Activities with CSIRO Education Specialists	Matt	Rachel	Matt	All
3.4.2 Test and Gain Feedback on the Developed Activities with our Peers	Matt	Rachel	Matt	All
4.1 Criteria of Successful STEM Programs	Rachel	George	Adam	All
4.1.1 Creation of a Real-World Relation	Rachel	George	Adam	All
4.1.2 Providing a Take-Home Item	Rachel	George	Adam	All
4.1.3 Ensuring Student Success	George	Rachel	Adam	All
4.1.4 Presentation of a Challenge	Rachel	George	Adam	All
4.1.5 Incorporation of Group Work	George	Rachel	Adam	All
4.1.6 Incorporation of Design and Build Step	Rachel	George	Adam	All
4.2 Activity Selection Process	Rachel	George	Adam	All
4.2.1 Activity Viability Based on Safety, Timing, and Cost	Rachel	George	Adam	All
4.2.2 Activity Interest Level	Rachel	George	Matt	All
4.2.3 Cross Analysis of Design Principles, Interest Level and Viability	Rachel	George	Matt	All
4.3 Considerations in the Development Process Specific to Science Bootcamp	Rachel	George	Matt	All
4.4 Activity Evaluation	Rachel	George	Matt	All
5. Conclusion and Recommendations	Rachel	George	Matt	All

5.1 Design Principles in STEM Activities	George	Rachel	Matt	All
5.2 Interest of Bootcamp Students	Rachel	George	Matt	All
5.3 Bootcamp Activity Appeal to Females	Rachel	George	Adam	All
5.4 Developed Bootcamp Activities	Rachel	George	Adam	All
5.5 Guide to Creation of Future Bootcamp Activities	Rachel	George	Adam	All
Appendix N: Magnet Activity Instructions	Matt	Rachel	Matt	All
Appendix O: Magnet Activity PowerPoint Instructions	Matt	-	Rachel	All
Appendix P: Magnet Activity Background Information	Rachel	-	Matt	All
Appendix Q: Magnet Activity CSIRO Connections	Adam	-	Rachel	All
Appendix R: Magnet Activity PowerPoint Slides	Matt	Rachel	George	All
Appendix S: Phone Speaker PowerPoint Presentation	George	Adam	George	All
Appendix T: Step By Step Instructions for Circuit Assembly	Adam	-	George	All
Appendix U: Amplifier Student Activity Sheet	Adam	George	Adam	All
Appendix V: Notes on Background Theory	George	-	Adam	All
Appendix W: Audio Amplifier Activity Template	Adam	George	Adam	All
Appendix X: Magnet Activity Template	Matt	-	Rachel	All

## Contents

Abstract .....	i
Acknowledgements .....	ii
Executive Summary .....	iv
Authorship.....	ix
List of Figures.....	xv
List of Tables.....	xvi
1. Introduction .....	1
2. Background.....	3
2.1 STEM Education .....	3
2.2 Experiential Learning to Motivate STEM Careers.....	5
2.2.1 Motivation in STEM Programs.....	7
2.2.2 Expectation of Success and Productive Failure in STEM Programs .....	8
2.2.3 Subjective Task Values in STEM Programs .....	9
2.2.4 Differences in Motivation due to Socioeconomic Status and Gender .....	10
2.3 Characteristics of Successful STEM Programs .....	12
2.3.1 STEM Education Bootcamp for Teachers .....	12
2.3.2 Worcester Polytechnic Institute (WPI) Frontiers Programs .....	13
2.3.3 American Chemical Society (ACS) Project SEED .....	14
2.3.4 Gateway STEM Schools.....	14
2.3.5 Design Principles of Experiential Learning Programs.....	15
2.4 The Work of CSIRO .....	16
2.4.2 Bootcamp Overview .....	18
2.4.3 Project Overview.....	19
3. Methodology Chapter.....	20
3.1 Objective 1: Identify Criteria of Successful Activities .....	20
3.1.1 Interviews with STEM Educators at WPI .....	20
3.1.2 Interviews with CSIRO Education Specialists to Confirm Design Principles.....	21
3.2 Objective 2: Evaluate and Assess Each Activity on our Selected List of Potential Activities Based on Given and Developed Criteria .....	22
3.2.1 Assessment of the Primary Criteria, Viability, and Design Principle Implementation .....	23
3.2.2 Evaluation of Activity Interest Level using a Focus Group and Survey.....	23
3.3 Objective 3: Fully Develop the Chosen Activities.....	25

3.3.1 Interview Experienced STEM Instructors to Determine Potential Challenges .....	25
3.3.2 Personal Assessment through Multiple Test Runs of the Activities .....	25
3.3.3 Peer Review of Developed Written Material .....	26
3.4 Objective 4: Pilot Test and Refine the Developed Activities.....	26
3.4.1 Test and Gain Feedback on the Developed Activities with CSIRO Education Specialists .....	27
3.4.2 Test and Gain Feedback on the Developed Activities with our Peers.....	27
Chapter 4 Findings .....	29
4.1 Criteria of Successful STEM Programs .....	29
4.1.1 Creation of a Real-World Relation.....	31
4.1.2 Providing a Take-Home Item .....	31
4.1.3 Ensuring Student Success .....	32
4.1.4 Presentation of a Challenge.....	33
4.1.5 Incorporation of Group Work.....	34
4.1.6 Incorporation of Design and Build Step.....	36
4.2 Activity Selection Process .....	36
4.2.1 Activity Viability Based on Safety, Cost, and Timing .....	37
4.2.2 Activity Interest Level.....	38
4.2.3 Cross Analysis of Design Principles, Interest Level, and Viability .....	42
4.3 Considerations in the Development Process Specific to Science Bootcamp .....	43
4.4 Activity Evaluation.....	48
5. Conclusion and Recommendations.....	51
5.1 Design Principles in STEM Activities .....	51
5.2 Interest of Bootcamp Students.....	52
5.3 Bootcamp Activity Appeal to Females .....	53
5.4 Developed Bootcamp Activities .....	54
5.5 Guide to Creation of Future Bootcamp Activities .....	54
References.....	57
Appendix A: Interview Questions for WPI Professors .....	61
Appendix B: Interviews with CSIRO Education Specialists to Evaluate Design Principles of Activities for Bootcamp .....	62
Appendix C: Long List of Activities .....	63
Appendix D: Student Focus Group for Evaluation of Activity Interest .....	64
Appendix E: Peer Survey Questions.....	65

Appendix F: Interviews with CSIRO Education Specialists to Determine Potential Challenges Faced with Chosen Activities .....	69
Appendix G: Focus Group with Peers who Participated in Pilot Test .....	70
Appendix H: Notes from Interviews with WPI Professors .....	71
Appendix I: Notes from First Round of Interviews with CSIRO Education Specialists .....	75
Appendix J: Primary Criteria for Activity Evaluation.....	87
Appendix K: Peer Focus Group Responses .....	89
Appendix L: Notes from Second Round of Interviews with CSIRO Education Specialists .....	91
Appendix M: Bootcamp Guide.....	97
Appendix N: Magnet Activity Instructions .....	120
Appendix O: Magnet Activity PowerPoint Instructions .....	127
Appendix P: Magnet Activity Background Information.....	130
Appendix Q: Magnet Activity CSIRO Connections .....	137
Appendix R: Magnet Activity PowerPoint Slides .....	140
Appendix S: Phone Speaker PowerPoint Presentation .....	160
Appendix T: Step By Step Instructions for Circuit Assembly .....	206
Appendix U: Amplifier Student Activity Sheet.....	212
Appendix V: Notes on Background Theory .....	220
Appendix W: Audio Amplifier Activity Template .....	226
Appendix X: Magnet Activity Template.....	260
Appendix Y: Summative Team Evaluation .....	281

# List of Figures

Figure 1: Australian participation rate in different subjects in year 12 (From Kennedy, Lyons, & Quinn, 2012) .....	4
Figure 2: The Experiential Learning Process (Adapted from Kolb, 2015) .....	6
Figure 3: CSIRO's objectives from its strategy for the years 2011-2015 (From CSIRO, 2011) .....	17
Figure 4: Activity Selection Process.....	22
Figure 5: Bootcamp activity selection process .....	36
Figure 6: Potential Bootcamp activity interest levels from peer survey .....	39
Figure 7: Topics for Bootcamp desired by previous Bootcamp participants.....	40
Figure 8: Male and female activity level grouped by subject .....	41
Figure 9: Evaluation of all potential activities based on interest, safety, cost, timing, and design principle implementation- A higher design principle score indicates that an activity better meets the criteria of a successful STEM program.....	43
Figure 10: Post-Bootcamp survey results indicating why an activity was least enjoyable .....	45
Figure 11: Post-Bootcamp survey results indicating why an activity was most enjoyable.....	45



# List of Tables

Table 1: Key design aspects of the four programs discussed.....	16
Table 2: Design Principles and Importance Scores.....	30
Table 3: WPI Professor and CSIRO Education Specialist feedback regarding student success in a STEM activity.....	33
Table 4: WPI Professor and CSIRO Education Specialist feedback regarding group work in a STEM activity.....	35
Table 5: Activity cost above and below \$15 per student .....	38
Table 6: Positive and negative aspects of labs as indicated through WPI peer focus group .....	40
Table 7: CSIRO education specialist feedback regarding instructor lecturing in a Bootcamp activity .....	47
Table 8: Aspects of developed activities that implement the design principles.....	49
Table 9: Schedule for Magnet Activity Before and After Pilot Testing .....	50

# 1. Introduction

Although the world revolves around scientific and technological advances, in the U.S., Australia, and other developed countries, high-school students exhibit declining interest in fields related to Science, Technology, Engineering, and Mathematics (STEM) (*2013 Teens*, 2013). In Australia, “STEM-based employment is projected to grow at almost twice the pace of other occupations. Yet currently, 41 per cent of employers are having difficulty recruiting STEM skilled technicians” (*Advancing*, 2007).

The U.S. and Australian governments have both been focusing on increasing the numbers of STEM programs. Australia’s government has gone as far as creating a “National Action Plan” to increase the effectiveness of its schools’ science education (Goodrum & Rennie, 2007).

Australia’s Commonwealth Scientific and Industrial Research Organisation (CSIRO) is a government organization that is helping increase student interest in STEM fields. CSIRO’s main focus is conducting and sponsoring scientific research aimed at improving the world, and, in addition, it emphasizes STEM outreach. In 2013-2014 alone, CSIRO’s Education Centers reached out to 366,305 students (CSIRO, 2015a) through initiatives such as awards which commend innovation and investigation, scientists and mathematicians who present to schools and mentor students, and STEM education programs for indigenous people.

Most recently, CSIRO has created the Science Bootcamp program, two-day immersive experiences in which secondary students are given tours of one of CSIRO’s many research facilities, meet CSIRO researchers, and perform their own experiments. In commenting on this program, CSIRO’s community engagement manager said “we hope a behind-the-scenes look at real science spaces and meeting CSIRO scientists will inspire the students to consider careers in science and engineering” (CSIRO, 2015b).

In furtherance of this engagement program, CSIRO asked our team to create additional hands-on activities for Bootcamp. To begin our work, we researched similar programs, interviewed leaders in STEM education, and developed a long list of potential activities. From these insights, we identified design principles for effective Bootcamp activities. Upon arriving in Australia, our team worked with CSIRO Education and Outreach (CEdO) coordinators to assess these activities and to develop a short list of preferred activities to begin building and testing. Our team delivered two complete activities (designed, tested, and fully implemented), we identified other activities for future consideration, and we provided the organization with a comprehensive guide on how to develop additional activities in the future.

This report explains our strategy for choosing the most promising ideas for activities, fully developing them into successful, engaging, and motivating activities, and pilot testing them. In Chapter 2, we build the necessary background knowledge and determine design principles that would make our activities most effective. In Chapter 3, we explain our process of narrowing down our initial list and choosing the activities we will develop. We also explain the methodology that we employed to implement the design principles to create successful, educational, and engaging activities for CSIRO's Science Bootcamp. In Chapter 4, we present the data collected from our methods, the analysis of the data, and the deliverables we produced, including the two completed activities and all the materials necessary to run them. We utilized the findings and analyses of the pilot tests to create a guide to help CSIRO develop additional activities in the future. In Chapter 5, we formulate our conclusions and provide recommendations for potential improvements.

## 2. Background

### 2.1 STEM Education

Science, Technology, Engineering, and Mathematics (STEM) fields have been immensely important to the advancement of many countries throughout the world over the last century. “Since World War II, science, mathematics and technical education subjects have been seen as the foundational knowledge needed by citizens for national development” (Fan & Ritz, 2013, p. 7). Humanity has created many of its technological and scientific marvels during this period of time, and STEM education has played a crucial role in accomplishing that level of innovation. Unfortunately, many countries are worried that a declining interest in the STEM fields amongst students is potentially slowing their technological advance.

Many emerging jobs in the global job market require some level of STEM proficiency. “International research indicates that 75 per cent of the fastest growing occupations now require STEM skills and knowledge” (Science, 2014, p. 7). Despite the growing number of STEM occupations, there won’t be enough STEM proficient employees to meet the needs of the international job market (Office of the Chief Scientist, 2012). Australia faces a similar critical situation and may find themselves beginning to lag behind other developed nations if changes are not made. To address this, one of the five most significant goals of Australia is “securing Australia’s place in a changing world” (Gough, 2014, p. 447). The country’s strategy is to use STEM education because “STEM underpins a differentiated and readily adaptable economy that is globally competitive and will enable all Australians to benefit from the opportunities that follow” (Science, 2014, p. 6).

The need for STEM workers may be explained by the fact that students in many countries have a decreased interest in STEM fields. In an international survey, 31% of countries surveyed reported a shortage of college enrollments and graduates in STEM disciplines (Fan & Ritz, 2013). In Australia, it was “found that the total number of students in Year 12 increased by around 16% from 1992 to 2012 while the participation rates for most Science and Mathematics subjects, as a proportion of the total Year 12 cohort, fell” (Kennedy, Lyons, & Quinn, 2012, p. 34) as seen in Figure 1.

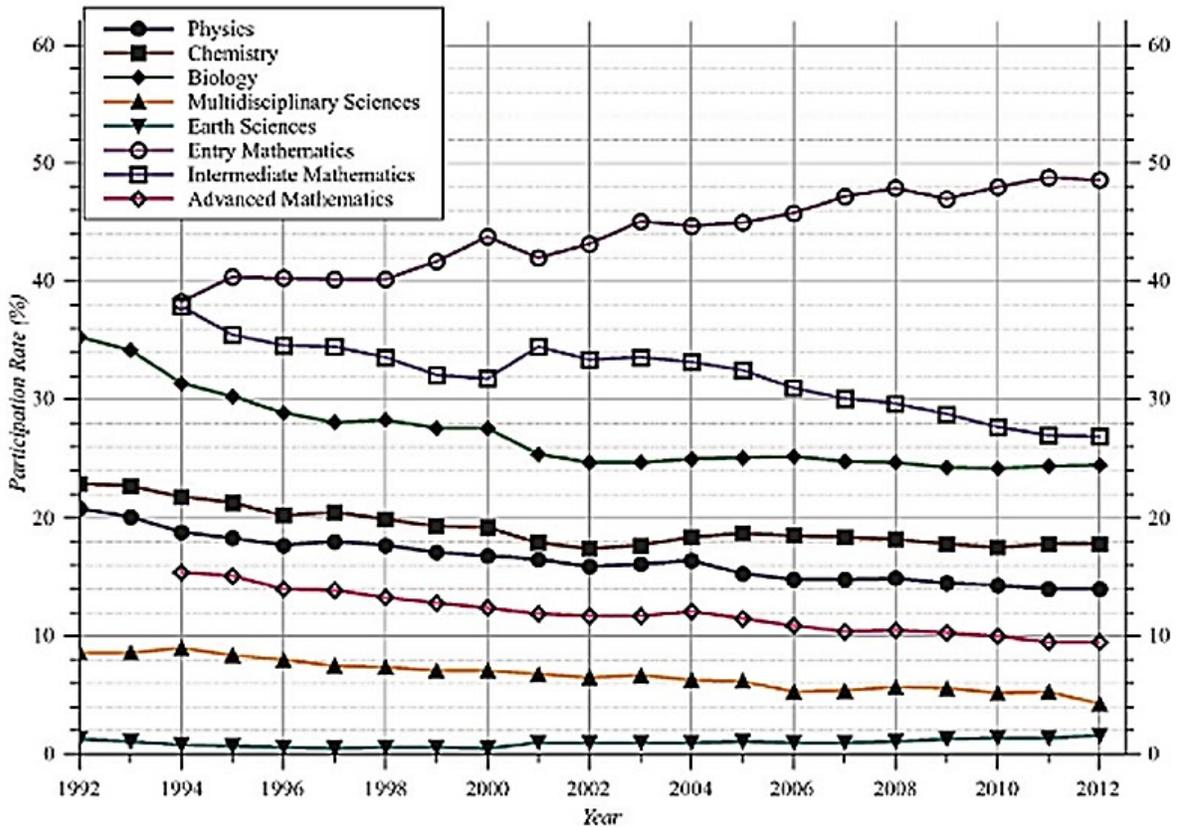

Figure 1: Australian participation rate in different subjects in year 12 (From Kennedy, Lyons, & Quinn, 2012)

This decrease in interest has affected Australia’s mathematics and science performance shown by the tests that the Organization for Economic Cooperation (OECD) conducts in the 34

participating countries. From 2006 to 2012, Australia fell behind 4 additional countries for science and from 2003 to 2012, for mathematics, Australia again fell 4 positions (International).

Australia's Federal government recognizes that its students are lagging behind and is developing a plan to improve Australia's quality of STEM education and knowledge. A report from 2013 states that by 2025, "the STEM enterprise will be widely accepted as a central and visible source of solutions to societal challenges" (Office of the Chief Scientist, 2013, p. 7). CSIRO plans to implement inquiry-based learning that involves critical thinking and the scientific method in the school system to improve the situation (Office of the Chief Scientist, 2013).

## 2.2 Experiential Learning to Motivate STEM Careers

A style of teaching seen in many STEM education programs is experiential learning. Experiential learning, or hands-on learning, teaches students in a way that teaches the competencies for real-world success (Center for Teaching and Learning, 2010). It not only encompasses learning the material at hand, but students remember better and are more interested in the topic (Kayes, Kayes, & Kolb, 2005). Experiential learning fosters this interest by providing a learning platform that addresses teaching as a multimodal approach. "The classroom, laboratory, or studio can serve as a setting for experiential learning through embedded activities such as case and problem-based studies, guided inquiry, simulations, experiments, or art projects" (Wurdinger & Rudolph, 2009). Due to the variety of ways one can encounter experiential learning, there are many opportunities for it to be implemented in the classroom.

Experiential learning increases a student's understanding and engagement. This increase in understanding can be explained in a quote by Confucius, "I hear and I forget. I see and I

remember. I do and I understand.” This increased learning potential is illustrated in one study where students’ grades were, on average, 6% higher when instructors used active learning techniques (Freeman et al., 2014, p. 8410). Students are more satisfied with higher grades that then provides them with the self-confidence and motivation necessary to succeed, further stimulating their interest in the subject matter (Pintrich & De Groot, 1990).

To make this experience most effective, 4 steps must be followed: concrete experience, reflective observation, abstract conceptualization, and active experimentation (Kolb, 2015). By going through the complete cycle shown in Figure 2, students refine their knowledge of a subject. Students make an observation about something they experience, hypothesize about it, and make discoveries and conclusions (Kolb, 2015). Students exposed to all four components of the experiential learning process will have an increased grasp and understanding of the presented information as well as increased engagement (Mehalik, Doppelt, & Schuun, 2008). By engaging students, experiential learning also functions as a motivating factor.

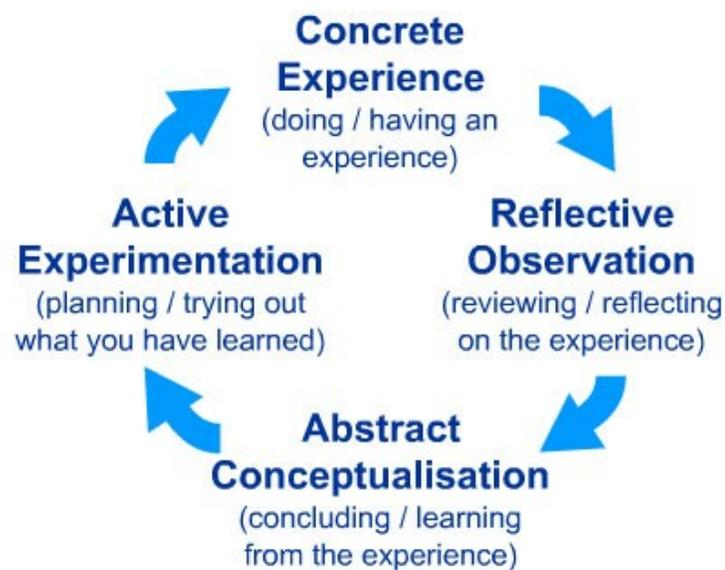

*Figure 2: The Experiential Learning Process (Adapted from Kolb, 2015)*

## 2.2.1 Motivation in STEM Programs

STEM programs utilize experiential learning to better achieve their learning objective and to get students motivated to participate in a hands-on activity. However, educating students and engaging them in the activities offered are not the ultimate objective of a STEM program. STEM programs are successful only if they manage to get students interested in pursuing an education in science and practicing a STEM related career path in the future. STEM programs are, thus, aiming to motivate students to study and practice STEM.

Psychology professors Edward L. Deci and Richard M. Ryan define that “to be motivated means to be moved to do something”, while educator Wanda Porter defines motivation as “the force that drives us to achieve the goal we want for ourselves”. Following these two definitions, the objective of STEM programs is to encourage students to set pursuing an education in STEM as their personal goal. According to psychology researcher Fredrik Jensen, “a student’s motivation for an educational choice consists of two main aspects: the expectation of success and the subjective task values attributed to the education in question” (Jensen, 2013, p.1438). Research on an out-of-school mathematics project shown that “children’s beliefs about their ability and expectancies for success are the strongest predictors of subsequent grades in math, predicting those outcomes more strongly than either previous grades or achievement values”. By influencing students’ beliefs about their potential to succeed, STEM programs can influence students’ performance and thus confidence in STEM related fields. The research also suggested that “children’s subjective task values are the strongest predictors of children’s intentions to keep taking math and actual decisions to do so”. By influencing students’ subjective task values about STEM, STEM programs can increase the likelihood that students will pursue STEM in the future.



## 2.2.2 Expectation of Success and Productive Failure in STEM Programs

Expectation of success refers to “the individual’s thoughts about how well he or she will do on an upcoming task” (Jensen & Sjaastad, 2013, p. 1439). “Attributing success to ability has positive motivational consequences, whereas attributing failure to lack of ability has negative consequences” (Wigfield & Eccles, 2000, p. 71). In addition, research suggests that teenagers tend to link their ability belief, “the individual’s perception of his or her current competence at a given activity”, with their expected success in the future (Wigfield & Eccles, 2000, p.70). Therefore, STEM programs should emphasize the correlation between the students’ success and their abilities, when students successfully complete a task. By emphasizing this correlation, students will also believe they will be successful in STEM related fields in the future. Research suggests that “adolescents’ ability beliefs and expectancies for success [are] consistently loaded together”. Students are more likely to pursue a career in STEM if they are confident they would be successful.

STEM programs should reward students’ efforts and also help students understand that failure is a necessary component of practicing STEM. STEM programs often rely on challenging the students in order to increase students’ engagement. Implementing a challenging aspect risks demotivating students from pursuing an education in STEM, since it increases the possibility of failure. If the students feel they failed at a task because of their lack of ability, research suggests they will also believe they would be unsuccessful in the same task in the future. A challenging aspect can be more safely introduced by choosing to “offer the possibility of productive failure”, where a given activity would be “structured in such a way that the outcome is not a given” (Frey & Fisher, 2010, p.31). Productive failure allows STEM programs to engage students in the activities offered without demotivating them from pursuing STEM in the future. The key to

effective implementation of productive failure is to encourage students to see failure as a necessary step towards success in STEM, rather than to attribute failure to their lack of ability.

### 2.2.3 Subjective Task Values in STEM Programs

Subjective task value refers “to the degree to which the task is able to fulfill needs, facilitate reaching goals, or affirm personal values” (Eccles, 1983, p.89). Do I want to complete this task and why? The subjective value of the task is broken down into “four components: attainment, interest-enjoyment, utility, and cost” (Jensen & Sjaastad, 2013, p.1439).

1. Attainment value refers to the identity of an individual, understanding “how important is it for me to be engaged in this task and do well?” (Jensen & Sjaastad, 2013, p. 1439).

Psychology researcher Eccles explains that a task would be of high attainment value to a student when “doing well in it would affirm a critical component of her self-concept” (Eccles, 1983, p.89). A student is more likely to pursue a STEM subject, when being good at it confirms her belief that she is smart. Interest-enjoyment value refers to “how enjoyable is the task” (Jensen & Sjaastad, 2013, p. 1439). “Will I have fun doing this? Am I interested?” (Jensen & Sjaastad, 2013, p. 1439).

2. Eccles associates interest-enjoyment value with the immediate enjoyment one feels when completing a task (Eccles, 1983, p. 89). Students become more motivated to practice STEM when they view it as a fun task.
3. Utility value “refers to how a task fits into an individual’s future plans” (Jensen & Sjaastad, 2013, p. 1439). For instance, “career awareness and prospects for further education and jobs” are identified as two important aspects of utility value (Jensen & Sjaastad, 2013, p. 1439). Students become more motivated to pursue STEM, when STEM

programs succeed in helping students understand how an offered activity relates to a future profession.

4. “Greater cost led to lessened probability of engagement in the related task” (Jensen & Sjaastad, 2013, p. 1440). If an activity appears to be “at the expense of other things,” for example time, money or failure and anxiety, students are less likely to become engaged (Jensen & Sjaastad, 2013, p. 1440).

STEM programs can encourage students to consider an education in STEM by ensuring there is an emphasis on the four discussed components. This emphasis will in turn increase the perceived subjective task value of the offered activities.

#### 2.2.4 Differences in Motivation due to Socioeconomic Status and Gender

Motivation for students to pursue science differs between socioeconomic backgrounds and both genders, however, the general principles that elicit motivation still apply. “Participation and achievement in mathematics and science by women, minorities, and the poor is disproportionately low” (Oakes, 1990, p.1). With regard to minorities and the poor, there are “fewer opportunities to learn science and math, largely because of the kinds of schools they attend” (Oakes, 1990, p.1). The sheer fact that these students do not have access to the same high-level science opportunities accounts for why fewer choose to pursue science fields. This does not mean, however, that they would be motivated differently if given the appropriate opportunities. During the past 40 years, it was found that the cultural variable does not typically influence interest or motivation. “Students with high interest in science come from families whose educational levels do not differ from those of families from which students with low interest in science come” (Hasan, 1975, p.260). In a more recent study, it was also shown that socioeconomic status influenced science aspiration but not how likely someone would pursue

science if given the opportunity (Archer et al., 2012). Opportunities in the sciences help develop “the self-concept that the individual has of their own ability” (Osborne, 2003, p.1072). Since people of low socioeconomic status have less opportunity, their perceived ability in the sciences is also lower which negatively influences their motivation to pursue a STEM field.

This idea of perceived ability is also a deterrence for women pursuing science, mostly due to societal stereotypes. In one study, “girls reported lower perceived ability than boys did regardless of achievement level and science class type” (DeBacker & Nelson, 2000, p.251). A reason for this lower perceived ability is that “confidence is eroded by the stereotypical belief that science is a masculine domain” (DeBacker & Nelson, 2000, p. 247). The key to women being motivated to pursuing a career in STEM is increasing their self-confidence. For example, “the women who enter the University of Washington with the intent to pursue a degree in engineering or science are highly-filtered achievers who start off with high levels of self-confidence in their academic abilities in math and science” (Brainard & Carlin, 1997, p.142). Women need to feel as though they can succeed which can be fostered by the completion of challenging tasks or activities. When women feel successful, a cycle ensues: higher achievement results in greater confidence and, in turn, the student then strives to maintain that high achievement (DeBacker & Nelson, 2000). Fostering this confidence through activity success is a critical aspect of a program that promotes STEM to women.

Another effective way to motivate women in STEM is to make the image of science broadly appealing by relating it to the real world. Women are more interested in the social impact of science which is a motivating factor. In one study conducted on 340 eleventh grade students that evaluated various factors influencing a student’s motivation to pursue science, it was found that “the social desirability science variable seems to operate on female students only”

(Hasan, 1975, p.260). Women are more likely to consider science's impact on real life when pursuing science. In another study, it was found that "girls in their sample rejected physical sciences because these areas were not viewed as helping or caring, instead preferring areas such as biology that would allow them to help people, animals, or the earth" (Jones, Howe, & Rua, 2000, p.182 ). This connection to the real world is a motivational factor for women that influences which sciences they pursue.

## 2.3 Characteristics of Successful STEM Programs

Various programs that educate students based on experiential learning result in the students being motivated and learning in a more effective way. There are many ways to implement experiential learning programs, whether in school, out of school, or during the summer. Below, we highlight four programs that each exemplifies effective components of successful experiential learning programs. Each program exhibits one or more specific techniques that make the program most effective.

### 2.3.1 STEM Education Bootcamp for Teachers

Steve Spangler's STEM Education Bootcamp is different than the other programs highlighted as it focuses on teachers instead of students. Spangler's program aims to show teachers how to balance fun and learning by integrating questions into all the activities. One of his key messages to teachers at Bootcamp is that "teaching must be done in a proper way, or it will turn into just a fun activity with no educational value" (Spangler, 2015).

A variety of experts endorse this balance. The ultimate goal is to "make the students think they are having fun, not realizing that they are learning" (Appelbaum & Clark, 2001, p.584). One way to do this is teaching the teachers to reinforce scientific concepts through hands-on activities and to develop question-based activities that get the students thinking critically and reflecting on

the experiment. These questions teach students “to make the connection between educational concepts, hands-on experiences, and real-world applications” (Spangler, 2015). Students will engage with the subject by either collecting their own data and answering their own questions or answering questions given to them as long as they draw their own conclusions (Bell, Smetana & Binns, 2005).

### 2.3.2 Worcester Polytechnic Institute (WPI) Frontiers Programs

The Frontiers programs, run by WPI, are two-week summer camps for high school students to learn about STEM challenges and projects using hands-on activities. WPI enhances these programs by incorporating a field trip aspect, competition, and a take-home product (WPI, 2015). WPI’s success at engaging students with these three aspects can be shown by the fact that, on average, 78% of students from the program apply to WPI each year (Suzanne M. Sontgerath, Personal Communication, October 8, 2015). Additionally, the average yield rate for students accepted to WPI who attended Frontiers is 44% whereas it is only 24% for students who did not attend Frontiers (Suzanne M. Sontgerath, Personal Communication, December 3, 2015).

In this program, students choose three STEM subjects where they are in the lab learning laboratory techniques from professors, going to workshops, and going on field trips to different laboratories and companies. Field trips help students recognize many out-of-school experiences that happen daily are actually related to science (Ramey-Gassert, 1997). The field trips are particularly successful in motivating women as they provide a connection between science and the real world. Students then participate in competitions which works well in this environment because “learning is achieved through a competition, but the learning result is independent of the student's score in such competition” (Burguillo, 2010, p. 568). The competitive aspect is “used to motivate students and [helps] improve their performance” (Burguillo, 2010, p. 568). Another

key feature of this program is having a tangible completed product after finishing the activity for the students to take home, such as a 3D printed object that the student designed, as it can be used to remind the student of his/her personal accomplishments (Felder & Silverman, 1988).

### 2.3.3 American Chemical Society (ACS) Project SEED

The SEED project run by the American Chemical Society (ACS) is a STEM program that helps students explore their interest in STEM by working directly in a laboratory and providing them with a mentor. Instead of a classroom, the students get to work in scientific research labs for the summer. Labs are “technology-enhanced, student-centered learning environments [that] provide interactive, complementary activities that enable individuals to address unique learning interests and needs, study multiple levels of complexity, and deepen understanding” (Hannafin & Land, 1997, p.168). A laboratory setting provides the student with a unique experience. While in the laboratory, each student works under a mentor who guides the students and explains how their studies connect to actual careers. Specific mentors like this have been shown to improve success. In one study, the average test score for mentored students was in the 99th percentile when compared to a control class with 30 students per teacher (Bloom, 1984). This one-on-one experience helps foster the self-confidence needed for motivation. Of the students mentored, half stated that they decided to attend college only after their experience and “75% stated the program helped them decide to pursue a career in science” (Hernandez, 2011, p. 1). This statistic is especially significant as almost all of these students were economically disadvantaged and initially “lack[ed] exposure to scientific careers” (About, 2015, p.1).

### 2.3.4 Gateway STEM Schools

The Gateway STEM School has fully integrated experiential learning into its teaching curriculum and has done so in a way that utilizes teamwork and connects the students’ learning

to a potential career. Gateway school's goal is to prepare its students for college and careers, especially in STEM. The school integrates teaching with the students' future careers. Students learn about the success they can have in STEM career and that "technical STEM skills receive greater compensation and provide more security and potential" (Feller, 2011, p.7). The students learn by doing the work that professionals do on a daily basis in their professional laboratories (Bayer, 2010).

The Gateway schools are also built around teamwork. Studies show that "work in a team provides students with access to many different learning, working, and writing styles, thus allowing students to gain a greater understanding of collaboration generally and of course concepts specifically" (Pfaff & Huddleston, 2003, p. 38). Many of the activities and projects are done in teams, and even the classrooms are considered a large team. The staff has its own team that works together to set up field trips, determine future changes to the curriculum, and share experiences with the new team members. These methods and efforts from the teachers resulted in a significant improvement in students' interest in STEM fields (Bayer, 2010).

### 2.3.5 Design Principles of Experiential Learning Programs

These STEM education programs each have elements that incorporate key design aspects for creating and running effective experiential learning activities. The principles that we extracted from these programs are summarized in Table 1.



Steve Spangler Bootcamp	WPI Frontiers Program	SEED Program	Gateway STEM Schools
<p>Educated teachers</p> <p>Integration of questions during the activity</p> <p>Balance between fun and education</p> <p>Tangible, finished item to take home</p> <p>Heavy focus on teamwork</p>	<p>Tangible, finished item to take home</p> <p>Integration of workshops and field trips</p> <p>Competitive aspect</p> <p>Program takes place in a laboratory</p> <p>Heavy focus on teamwork</p> <p>Creates a link between STEM subjects and a career</p>	<p>Each student has a particular mentor</p> <p>Program takes place in a laboratory</p> <p>Creates a link between STEM subjects and a career</p>	<p>Creates a link between STEM subjects and a career</p> <p>Heavy focus on teamwork</p> <p>Program takes place in a laboratory</p> <p>Integration of workshops and field trips</p>

*Table 1: Key design aspects of the four programs discussed*

This summary points out the successful elements each program implements many of which are seen throughout multiple programs. Connecting to real life and careers through lab work seen in green is used in many of these programs to help demonstrate science’s social impact. Teamwork, mentoring, competition, and integrating questions all connect in that they aim to provide the participant with confidence for success.

## 2.4 The Work of CSIRO

The Commonwealth Scientific and Industrial Research Organisation (CSIRO) runs several STEM educational programs, most of which implement experiential learning to make the experience most effective. CSIRO is one of the largest and most diverse scientific organizations in the world, whose goal is to do work that benefits Australia. These include carrying out research to further the interest of the Australian community, contributing to the achievement of Australian national objectives, and any other purpose deemed important by the Minister (CSIRO,

2011). Amongst other achievements, CSIRO has invented WiFi and has 3D printed a titanium rib cage for a cancer patient’s surgery (Knight Adam, 2015). The Minister for Innovation, Industry, Science, and Research has stated that “for 85 years, CSIRO has carried the ambitions of the Australian people” and that “we cannot imagine a world without its discoveries” (CSIRO, 2011, p. 4). As previously stated, one of the five most important objectives for Australia, and thus for CSIRO as well, is to stimulate increased student.

Interest in STEM related majors. CSIRO is striving to attain this objective by raising community awareness of science and science education. In Figure 3, shown below, CSIRO includes its objectives for the years 2011-2015, their decision of "promoting public understanding of science" and "sharing [their] knowledge and providing expert advice" (CSIRO, 2011, p. 12).

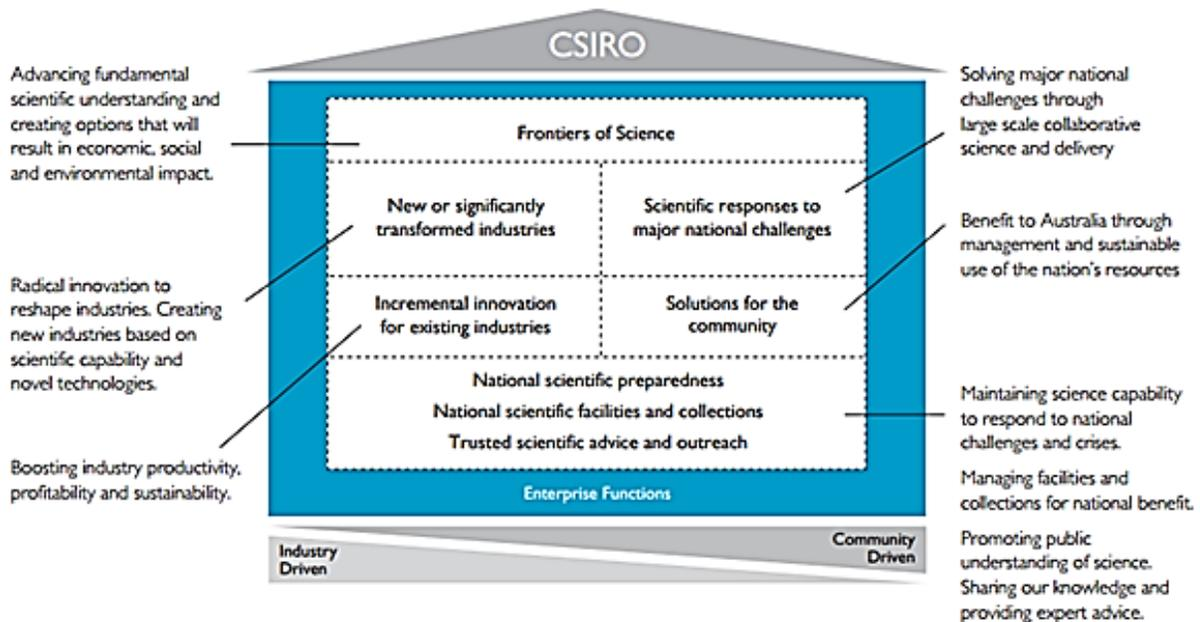

Figure 3: CSIRO’s objectives from its strategy for the years 2011-2015 (From CSIRO, 2011)

### 2.4.1 CSIRO Education Programs

With the objectives of striving for "national scientific preparedness" and providing "trusted scientific advice and outreach," and with the characteristic of being a heavily community driven organization, CSIRO has organized many educational events throughout the past several years (CSIRO, 2012, p.59). These include public seminars, holiday science activity camps, and award programs. According to CSIRO's statistics, "each year CSIRO Science Education Centres reach 1.2 million students, parents, and teachers through activities that focus on science" (CSIRO, 2011, p. 9). These educational outreach initiatives are a prime example of using experiential learning principles to spike student interest. In the CSIRO annual report for 2011-2012, CSIRO claims that in the Discovery Centre, where "students are taken through a 90-minute minds-on, hands-on program", the "attendance [...] continues to increase, with 43,000 students visiting the Centre in 2011-2012" (CSIRO, 2012, p. 59). The most recent addition to CSIRO's Education and Outreach program has been the Science Bootcamp, which was created to function primarily as a gateway to future STEM related career paths and secondarily as an educational program.

### 2.4.2 Bootcamp Overview

The Science Bootcamp initiative is a two-day educational program geared for students aged 13 to 18 years old. The program aims to get the students in touch with various STEM fields. To accomplish this, students "undertake various investigations and activities using scientific apparatus and technology" to scientifically resolve a given experimental project (CSIRO, 2015a). The premise behind the Science Bootcamp is that students who take part in the program will be inspired to consider future careers in one of the STEM fields. In order to achieve this objective, the program provides a perspective of science that schools cannot; it exposes students to

“authentic scientific research in contemporary research facilities and gives the students the chance to meet and talk with CSIRO researchers" (CSIRO, 2015a). By “visit[ing] laboratories and see[ing] the research currently being performed”, students are given practical insight on what it is like working in the industry, should they decide to get involved in a STEM related career (CSIRO, 2015a).

Since the program is a fairly new addition to CSIRO’s Educational Outreach (CEdO), only two experiments are currently run. The first one is a DIY, or ‘Do It Yourself,’ gel electrophoresis activity, where students understand the processes of DNA extraction and gel electrophoresis, and the second is a 3D printing exploration activity, where students undertake a wind turbine design task. Consequently, CSIRO has decided to focus on increasing the variety and quality of the activities offered and has asked our team to work towards this objective.

### 2.4.3 Project Overview

The goal of our project was to assist CSIRO in improving the experience offered by the Science Bootcamps. The main objective was to propose, evaluate, develop, and test ideas for activities and then provide the agency with a few fully completed activities, along with a guide on how to develop additional ones in the future. We believed the proposed activities would be most successful if we first agreed on the design principles they should follow. In the next chapter, we explain our strategy of determining and evaluating these principles and our methods for implementing them in order to create successful, educational, and engaging activities.

## 3. Methodology Chapter

The goal of this project was to aid the Commonwealth Scientific and Industrial Research Organisation (CSIRO) in fully developing new educational and engaging activities for its lab-focused Bootcamp program and to provide a guide for the design of future activities. In order to accomplish this, we completed the following objectives:

1. Identified criteria of successful activities
2. Evaluated and assessed our selected list of potential activities based on given and identified criteria
3. Fully developed the chosen activities through personal assessment
4. Pilot tested and refined the developed activities

### 3.1 Objective 1: Identify Criteria of Successful Activities

In order to get ideas for the types of activities we suggested for development, we first determined what criteria the activities must meet. Interviews were conducted with STEM educators from both WPI and CSIRO to gain their perspective on what aspects of an activity are most important in engaging and motivating students. The interviews, as well as background research conducted on other successful programs, helped formulate a list of design principles along with a ranking of which ones were most important. In addition, a long list of activity ideas was created based on our research, an exploration of equipment at CSIRO, and identified design principles obtained from the interviews.

#### 3.1.1 Interviews with STEM Educators at WPI

To explore activity requirements and create our list of potential activities, we conducted two sets of semi-structured interviews. We conducted semi-structured interviews to get direct answers and to allow for probe and follow-up questions that elicit explanations. We conducted

six interviews with professors at WPI who ran various summer programs for high school students. From this, we determined what hands-on activities they have conducted, which aspects of the activities were successful, and which aspects could be improved. Sample questions are as follows:

- What specific activities have you run with high school students?
- Was the activity successful in educating and entertaining the students? How do you measure or determine its level of success?
- Would you do anything differently if you were to run this program again?
- What principles have you implemented in activities or do you think are good principles to integrate in order to improve the quality of an activity?

All questions that were asked can be seen in Appendix A. Notes were taken to document answers. After all of the interviews had been conducted, we listed any potential activity ideas. In addition, aspects of activities that were indicated across multiple interviews to be successful were observed. Using this observation, along with our research, we drafted an initial list of design principles which was further investigated and confirmed through our second set of interviews.

### 3.1.2 Interviews with CSIRO Education Specialists to Confirm Design Principles

The second set of semi-structured interviews determined the most important criteria for a successful activity in a Bootcamp. We talked with seven CSIRO education specialists who have experience running Bootcamp or other educational programs that CSIRO conducts and who were recommended to us by the Bootcamp Coordinator. By interviewing these educators, we gathered information about what key design principles they implement in a typical hands-on activity. The questions asked, which can be found in Appendix B, were similar to those asked to WPI professors, but some questions were directed to gather information about activities specific to CSIRO. In addition to the open-ended questions, we also asked the interviewees to rate the design principles we had developed on a scale of 1 to 10 based on their importance to a Bootcamp activity. Having completed research, as well as the interviews with WPI professors

and CSIRO education specialists, we compiled a complete list of potential design principles with their importance indicated. The list was used in Objective 2 to evaluate which activities would be best and was used to create a guide for the development of future activities.

### 3.2 Objective 2: Evaluate and Assess Each Activity on our Selected List of Potential Activities Based on Given and Developed Criteria

We considered the practicality of each activity on our long list, found in Appendix C, for use in CSIRO’s Bootcamp. In order to narrow down our long list, we conducted an initial evaluation, an evaluation of safety, cost, and timing, and determined which design principles would be possible to implement for each activity. Along with this, an evaluation of interest level, determined by a survey of and focus group with our peers, was used to evaluate activities. After gathering all of this information, our team selected the viable activities to develop. The flow of this evaluation is shown in Figure 4.

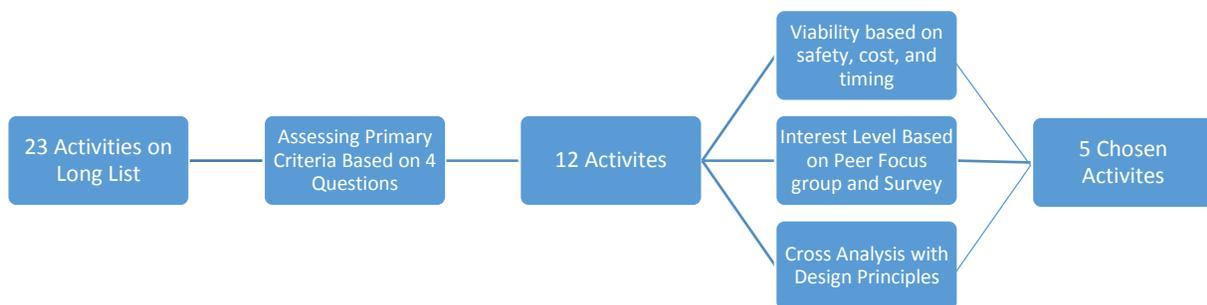

*Figure 4: Activity Selection Process*

### 3.2.1 Assessment of the Primary Criteria, Viability, and Design Principle

#### Implementation

The long list of activities was initially shortened using four primary criteria questions that were created based on suggestions from the Bootcamp coordinators. The list was narrowed down more quickly than originally planned because there was an activity selection deadline. By initially shortening the list, we were able to streamline the process by only evaluating activities that were appealing to CSIRO. The four questions we asked about each activity on the long list to evaluate appeal to CSIRO are below:

1. Is this activity different from those CSIRO has previously conducted?
2. Is this activity related to CSIRO research and would work well within CSIRO?
3. Does this activity interest the Bootcamp coordinators and STEM experts?
4. Does this activity interest us based on our experience and background knowledge?

An activity score was tabulated based on how many positive responses each received. The highest scoring activities were selected for further consideration.

The selected activities were assessed for viability based on safety, cost, and timing to determine which activities met the constraints of Bootcamp. We then determined which design principles found in Objective 1 could be incorporated in each activity.

### 3.2.2 Evaluation of Activity Interest Level using a Focus Group and Survey

After assessing the primary criteria, viability, and design principle implementation, we determined what subjects and activities potential Bootcamp students would be interested in. To do so, we conducted a focus group with six of our peers from WPI. CSIRO Bootcamp coordinators preferred that we reach out to our peers, who are only a few years older than our target audience, because it guaranteed all focus group volunteers have interest in STEM. Our



team guided the volunteers through a discussion of questions in which each participant voiced his/her opinion. Sample questions are shown below (all questions can be found in Appendix D):

- Do you like doing labs or listening to a lecture better? What aspects make one better than the other?
- Of this list of activities, which ones stand out to you based on their titles?
- After hearing the activity description, do the same activities still stand out from before?

With each question, there was also an open discussion for participants to build upon the opinions of others. We used the statements and opinions of individual students and the group as a whole to determine which activities held the most promise for further development.

We also sent out a survey on Facebook for a broader cross section of our WPI peers to complete. This survey, found in Appendix E, was posted on closed Facebook groups that consist of only WPI students who will graduate in either 2017, 2018, or 2019. This survey had the students rate the appeal of our list of potential activities on a scale from 1 to 10 after reading a short description of each activity. Each description was three sentences long and aimed to convey the same level of detail to avoid any bias. The two previous Bootcamp activities, the DIY gel electrophoresis and 3D printed wind turbine, were also included as a control, so we were able to compare our activity ideas to previous successful ones. The survey also asked for student gender and major as well as comments for improvements or additions to any of the activities. The results provided us with quantitative and qualitative data to utilize in our analysis of potential activities. Based on interest, viability, and design principle implementation, a shortened list containing five activities was presented to the Bootcamp coordinators. These activities were our most effective, entertaining, and educational, and were the easiest to implement. The activities on the list were then further developed in Objective 3.

### 3.3 Objective 3: Fully Develop the Chosen Activities

Before beginning work on each proposed activity on our shortened list, we conducted a second set of interviews to determine the positives and negatives of each activity. These interviews were conducted with experienced CSIRO education specialists that have been involved in past Bootcamps. We acquired all material to develop the two best activity ideas and ran the complete activities ourselves as a mock Bootcamp with no students present. We used the data collected from each trial to completely document the procedure, including any useful tips and shortcuts for the instructors. Afterwards, all written material was reviewed by our peers to complete the development stage.

#### 3.3.1 Interview Experienced STEM Instructors to Determine Potential Challenges

In order to begin implementation of the activities, we interviewed five experienced education specialists who have worked at CSIRO Bootcamps with the goal of learning what challenges we needed to consider when running our specific activities. Each interview began with an explanation of the proposed activity practices, and the interviewee was asked to discuss these practices in terms of effectiveness. There were also additional open-ended questions about potential difficulties we might face and how we might resolve them. The interview also provided the instructors with some time at the end to provide additional comments that they decided were useful to our project. A complete list of interview questions can be found in Appendix F. The answers to the questions were used to modify the activities and avoid possible issues during development.

#### 3.3.2 Personal Assessment through Multiple Test Runs of the Activities

In order to develop the activities, we needed to personally perform them to prove their viability. Using all gathered information and materials, we ran the activities ourselves. One

member of the team produced the procedure for each activity, and the other team members who had little involvement with the development of the procedure, tested the activity. The team member who developed the procedure set up the activity in order to evaluate the content. This team member evaluated through observation and recorded any tips we believed were useful for the educators who will run Bootcamps in the future and recorded any possible errors that might be made by both the educators and the students. The time required to conduct the activity was also recorded and used to modify the activity to ensure it could be set up, performed, and cleaned up, within the necessary time frame.

### 3.3.3 Peer Review of Developed Written Material

All written material for the activities was created and edited by conducting a peer review with WPI students. These materials included PowerPoint presentations that will be used to present the activities to the students of the Bootcamp and various instruction sheets for both the educator and students. Each document was reviewed by two peers. The procedures and presentations were printed out and given to our peers for review to confirm that the steps were clear and easy to follow and that all necessary background information was presented. To gather their feedback, a member of the team conducted an unstructured interview with each peer to inquire about improvements to be made. The responses were recorded on paper and all relevant changes made.

### 3.4 Objective 4: Pilot Test and Refine the Developed Activities

Our team's final step was to improve and assess the effectiveness of our completed activities through pilot testing with CSIRO education specialists and peers from WPI. Pilot testing assessed how effective the activities were on people other than ourselves. With our team's guidance, the volunteers performed the activity as if they were attending Bootcamp. After

pilot testing, our team led a focus group to assess the activities' effectiveness in educating and engaging participants and in implementing design principles to note the areas that needed improvement.

### 3.4.1 Test and Gain Feedback on the Developed Activities with CSIRO Education Specialists

A pilot test was completed with two CSIRO education specialists in order to gather their feedback on the activities. This ensured both activities we chose were developed in a way that was engaging and that all supplemental material was clearly written and easily followed. Due to time constraints, the CSIRO education specialists were only able to complete the hands-on portions of the activities and the background knowledge presentations were left out. We obtained opinions on the presentations through informal interviews guided by one of our team members after the pilot tests. Questions about their experience during the activity, where they saw room for improvement, and what elements of the design principles were effective were asked. The questions asked to the CSIRO education specialists were:

- Do you think that this activity was different and interesting compared to what a student may be exposed to in school? Where there aspects of the activity that were exciting? Parts that were boring?
- What is your definition of educational value? What is the educational value of this activity? What procedural aspects made this educational?
- What parts were not clear or do you think need further explanation?
- What do you think could have been done better? Would you change anything involving the design of the activity?

### 3.4.2 Test and Gain Feedback on the Developed Activities with our Peers

After pilot testing our activities with CSIRO education specialists, we conducted pilot tests with individuals closer in age and experience to those who attend CSIRO's Bootcamp. Because we were unable to test our activities with secondary school students, we conducted pilot

tests with our peers from WPI. The goal of the pilot tests was to make sure the activity is doable and fills the correct amount of time. Unlike the pilot tests with CSIRO education specialists, our peers were presented with the background knowledge along with completing hands-on demonstrations. During the pilot tests, our peers were given an observation sheet to note any suggestions as they progressed through the activity. A team member observed the pilot tests and took notes. The pilot tests ended with a focus group. The full list of questions asked during the focus group can be found in Appendix G. Some sample questions asked during the focus group were:

- Did you have fun? Why or why not?
- Were there times that bored you? When and why?
- What did you learn or learn about?
- Did the activity peak your interest more in STEM fields? Why or why not?
- What would you do to improve any of the activities?
- What parts did you not understand or would like further explained?
- Would you attend this Bootcamp activity?

After we completed both pilot tests, we analyzed the responses acquired in the pilot test observation sheets and focus groups. We looked for trends in the answers from each group and determined what changes need to be made for our deliverables. After making these changes, we had a completed procedure for activities that CSIRO can implement in its Bootcamp.

## Chapter 4 Findings

The findings in this chapter synthesize research reported in Chapter 2 and an analysis of the interviews, focus groups, surveys, and pilot tests described in Chapter 3. That synthesis resulted in a set of criteria for a successful Bootcamp activity described in the next section that were used to select activities. We conclude this chapter by evaluating these activities against the standards we established.

Our findings provided CSIRO with two complete activities, the phone speaker activity and the magnetic putty and ferrofluid activity. Through our findings, we demonstrate how to make a STEM education activity successful and also provide CSIRO with a guide that includes tools and information to create additional effective activities in the future.

### 4.1 Criteria of Successful STEM Programs

Combining insights from interviews with education experts and insights from the research literature, we determined the six most important design principles that should be met by a successful activity. These design principles include:

- Creating a real-world connection
- Providing a take-home item
- Ensuring student success
- Including a challenging aspect
- Incorporating group work
- Having both a design step and a build step

The six design principles listed above were extracted from an original eight that included implementing a competitive aspect and having many small tasks. The eight design principles were weighted for importance in Science Bootcamp activity through interviews with CSIRO education specialists. Table 2 indicates the importance score of each aspect. This importance score was determined by averaging the rating from 1 to 10 that each of the seven CSIRO

education specialists gave the specific principle. Each score was then rounded to the nearest .5 value.

	<u>Take Home Aspect</u>	<u>Real World Relation</u>	<u>Success</u>	<u>Challenging</u>	<u>Group Work</u>	<u>Design and Build</u>	<u>Competitive</u>	<u>Small Tasks</u>
<b>Rounded Average</b>	<b>9.0</b>	<b>9.0</b>	<b>8.0</b>	<b>7.5</b>	<b>7.5</b>	<b>7.0</b>	<b>4.0</b>	<b>3.0</b>

*Table 2: Design Principles and Importance Scores*

Based on these importance scores, it was found that implementing a competitive aspect and having many small tasks are not crucial to a successful Bootcamp activity. They are less essential because, as one CSIRO education specialist said, “competition makes some kids really uncomfortable,” and “you don’t really need to have small things. People get distracted.” Even though these two principles are not as essential as the other six, they are not a negative addition to an activity. If competition is implemented, as a CSIRO education specialist during an interview suggests, “it should be constructive competition.” In regard to small tasks, another CSIRO education specialist said, “it doesn’t matter the number of tasks, but there has to be some kind of variety.”

The six remaining design principles that make a STEM activity effective are creating a real-world relation, providing a take home item, ensuring student success, presenting a challenge, incorporating group work, and incorporating both a design and build step. The following six sections go through each principle individually in order to discuss our findings regarding how to implement each effectively.

### 4.1.1 Creation of a Real-World Relation

Connecting STEM to the real-world allows a student to see that a topic is relevant.

Through interviews with WPI professors and CSIRO education specialists on successful STEM programs, we determined that any or all of the following can be incorporated into an activity in order to create a real-world relation:

- An analogy or metaphor
- A connection to research
- A demonstration that models a real life scenario
- An interesting fact

These techniques to create a real-world relation are supported by interview results found in Appendices H and I. A real-world relation can “help [students] understand how the activity relates to their daily life,” as one WPI professor stated. Another professor stated that “real-world relations expand their mind.” Other investigators have found that a real-world relation motivates women because they see a social impact (Jones et al., 2000). The materials that a STEM activity, including Bootcamp, provides should present a real-life concept that parallels the activity to gain more female interest.

### 4.1.2 Providing a Take-Home Item

An item that a student brings home enhances the effectiveness of a STEM program because it reminds the student of his or her accomplishments. One CSIRO education specialist stated that she “definitely saw satisfaction in students having completed and taking home something.” Another specialist said students “want something that they can show to their family and it completes their learning.”

Any type of take-home item usually satisfies the students as long as they receive something. One CSIRO education specialist said “it reinforces their interest, even if it’s something very cost-effective.” Three WPI professors said that the take-home item that was



provided to the students was a poster they created or a flash drive containing additional information. An optimal Bootcamp activity should include a take-home item students created themselves. If this optimal item is not an option, the take-home item could be information for further investigation on the subject matter that the activity involved.

#### 4.1.3 Ensuring Student Success

Student success is critical for a STEM activity because otherwise, the student either feels disappointed or incompetent. Research findings and experts that we interviewed suggest that interest in STEM is dependent on how successful the students feel. One source stated, “attributing success to ability has positive motivational consequences, whereas attributing failure to lack of ability has negative consequences” (Wigfield & Eccles, 2000, p.71). Wigfield argued that when students fail to complete a task, they become less confident in their abilities and are less likely to pursue similar tasks in the future (Wigfield & Eccles, 2000). Students should understand that failure is a necessary component of practicing science, instead of believing failure reflects on their lack of ability. Students, especially females, should be rewarded for their efforts while participating in any STEM program. There should be a focus on females because “girls reported lower perceived ability than boys did regardless of achievement level and science class type” (DeBacker & Nelson, 2000, p.251) which discourages them to pursue STEM. This approach to student success is supported by the evidence acquired through interviews with WPI professors and CSIRO education specialists summarized in Table 3 which were extracted from the full interview responses found in Appendices H and I.

<p><b>Disappointment</b></p>	<p>- “Make sure the students don’t get disappointed or feel incompetent. All students should get rewarded in some kind of way.” – WPI Professor</p> <p>- “Many students would get very disappointed if they didn’t get something working.”- CSIRO Education Specialist</p>
<p><b>Success in Bootcamp</b></p>	<p>- “You cannot have Bootcamp without finishing the project.” – CSIRO Education Specialist</p> <p>- “90% have to complete the activity, all of them have to get pretty close”- CSIRO Education Specialist</p> <p>- “All students should get rewarded in some kind of way.” – CSIRO Education Specialist</p>
<p><b>Failure</b></p>	<p>- “Hey, this is real science.” “Almost like a life lesson”. –CSIRO Education Specialist</p> <p>- “You don’t want to set the kids up to fail, but you also want to teach them about the reality.” – CSIRO Education Specialist</p>

*Table 3: WPI Professor and CSIRO Education Specialist feedback regarding student success in a STEM activity*

To ensure success, Bootcamp should aim to get all students close to completing the activity and provide additional information and tips for students who are struggling. Bootcamp should also teach students how to handle failure and help students see that failure is a step towards future success. After the completion of an activity, extra instructions should be given to students because in the case they do not finish the activity, they can complete any missing parts at home.

#### 4.1.4 Presentation of a Challenge

A challenge should be presented to the students because students feel a sense of accomplishment when completing a difficult task. If a program “includes high expectations for all students, sufficient resources and a commitment to the belief that students can achieve [...] it can be an effective strategy to help students reach high learning standards” (Upcraft, Gardner, &

Barefoot, 2004, p.1). We see the effectiveness of incorporating challenging elements based on what one CSIRO education specialist said about a previous Bootcamp: “there were plenty whose experiments didn’t work, but many got very happy when they managed to make it work.”

One consideration when implementing a challenge is that some students prefer challenges more than others. As one CSIRO education specialist indicated, there are going to be “the top kids, five percent, who want to push themselves, the middle majority who want to do something that tests them a bit but still want to achieve, and the bottom group who wants it to be easy.” Students like to accomplish a task successfully. However, some students feel a higher or lower sense of accomplishment based on the steps taken to complete the task. In order to make a challenge effective for all students, an activity should include options, such as providing a guide that the student can choose whether or not to use. We decided to provide help to those students who want or need it with detailed instructions while still allowing more advanced students to embrace the challenging options.

#### 4.1.5 Incorporation of Group Work

STEM programs should incorporate the element of group work in the activities they offer. When students work in groups, they are motivated, learn better and enjoy the activity more. “The energy and motivation that occur when students are engaged in productive group work result in meaningful learning” (Frey & Fisher, 2010, p.30). One CSIRO education specialist claims “it helps to pair them up for the learning, enjoyment and motivation.” The most effective design of an activity includes group work that addresses the following parameters:

1. For hands-on activities, the optimal group size is 3 to 5 students
2. For answering questions, students should be paired to allow for discussion
3. Include a mixture of both individual activities and group activities

4. Change group members throughout the activity

These suggestions for the appropriate approach to group work are supported by evidence acquired through literature review, interviews with WPI Professors, and CSIRO education specialists summarized in Table 4. The complete WPI and CSIRO interview results are in Appendices H and I. We integrated these parameters on effective group work into our Bootcamp activities.

Pairs for Answering Questions	- “Have them team up in pairs of two and share the answer so they are then willing to take the risk to answer the questions.” – WPI Professor
Mix of Individual and Group	<p>- “Not for the whole time. But there needs to be an element of that. You get some kids who are not so interested, so it does help to group them up for the learning, enjoyment and motivation.” – CSIRO Education Specialist</p> <p>- “My strategy in cases where there is a wide age range is to group them by age, group them at different times and based on different categories, sometimes you want them mixed sometimes you don’t.” – WPI Professor</p>
3 to 5 Students	<p>- “If there are too many students in a group, some of them are not motivated to complete any tasks as they know the work will be done by others. If there aren't enough members in a group, students begin to feel overwhelmed and give up on the task.” (Frey &amp; Fisher, 2010, p.35)</p> <p>- “Teamwork, teams of 3 to 5.” – WPI Professor</p> <p>- “Work in teams of either 3 or 4.” – WPI Professor</p>

*Table 4: WPI Professor and CSIRO Education Specialist feedback regarding group work in a STEM activity*

#### 4.1.6 Incorporation of Design and Build Step

Based on research and interviews, we found that students enjoy both a design step and a build step when completing an activity. In addition to student interest in a design and a build step, “learning by design is designed to encourage engagement, reflection, science talk, [and] case-based reasoning” (Fasse & Kolodner, 2013, p.198). Learning by design is essential because it not only engages students, but “students enjoy the design greatly,” as one WPI professor indicated. The professor also stated that although design was enjoyable, students “spent more time building, but also were tweaking the design as they were building.” In order for Bootcamp to effectively incorporate this design principle, the design step must be related to the building step. There should also be chances for students to change their design. One CSIRO education specialist said, “there were bits that more advanced students could expand upon.” Because education levels vary in Bootcamp, a good way to incorporate an effective design step is by giving the students choices in what they build.

#### 4.2 Activity Selection Process

The overall process for selecting our activities is shown below in Figure 5. This section will discuss our findings for each step of the selection process.

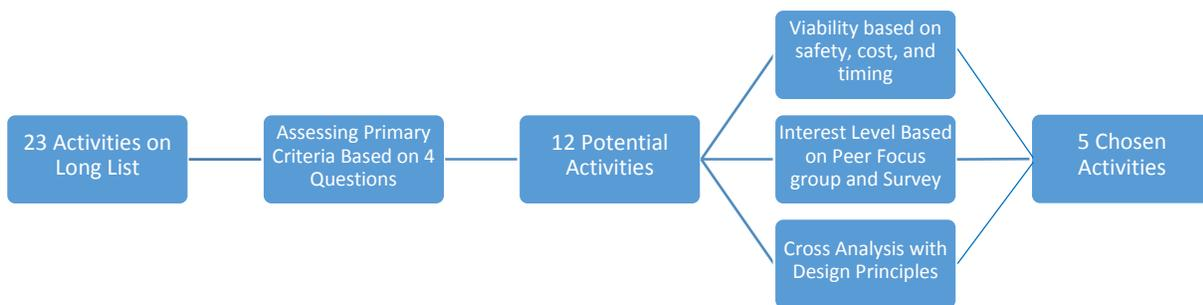

*Figure 5: Bootcamp activity selection process*

Our selection process began by narrowing down 23 activity ideas, which we brainstormed based on our academic experiences, websites with STEM activities, and information shared to us by interviewed WPI professors, to 12 through assessment of primary criteria. The primary criteria are:

1. Is this activity different from those CSIRO has previously conducted?
2. Is this activity related to CSIRO research?
3. Does this activity interest the Bootcamp coordinators and other STEM experts within CSIRO?
4. Does this activity interest us based on our experience and background knowledge?

These questions were asked for each activity. Any activity that had 3 or 4 positive responses, or answers of ‘yes’, were selected for further investigation. The results of this evaluation can be seen in Appendix J. After this evaluation, safety, cost, timing, interest level, and implementation of design principles were evaluated. These considerations are discussed in detail in the following sections.

#### 4.2.1 Activity Viability Based on Safety, Cost, and Timing

It was determined that 7 of the 12 activities that met the primary criteria evaluation met CSIRO’s requirements for safety, cost, and timing. For any Bootcamp activity, the following conditions defined by CSIRO must be met:

1. Safety: All safety concerns must be addressed
2. Cost: All materials required for an activity must cost less than \$15 AUD per student.
3. Timing: The activity must run for 90 minutes on the first day of Bootcamp and for 120 minutes on the second day of Bootcamp.

To determine safety, any risks were listed and compared to CSIRO’s standards with feedback from CSIRO’s Bootcamp Coordinator. Control factors for each risk were listed, and if the control factors minimized the risk to meet CSIRO’s standard guidelines, the activity was approved. To determine cost, a list of materials was made, and these materials were found on

websites that ship to Australia. To determine time, estimates for each part of the activity were made based on CSIRO education specialists' input.

We found that cost was always the aspect that caused an activity to be completely eliminated because safety and time could be adjusted. Cost was the main factor because activities that had clear safety concerns never made it on the initial long list. Parts of activities could be added or removed to satisfy time requirements. Adjustments were made to account for the cost of necessary parts of all activities. However, only some parts were able to be adjusted enough to lower the budget below \$15. Table 5 below compares affordable activities to those that, even after adjustment, were too expensive.

Activities Above \$15	Activities Below \$15
<ul style="list-style-type: none"> <li>● Quadcopter</li> <li>● Propeller Clock</li> <li>● Argo Float</li> <li>● 3D Printed Helmet</li> <li>● ELISA Assay</li> </ul>	<ul style="list-style-type: none"> <li>● Magnetic Putty and Ferrofluid</li> <li>● Phone Speaker</li> <li>● ECG</li> <li>● Digital Clock</li> <li>● 3D Printed Bridge</li> <li>● UV Sensor</li> <li>● Molecular Gastronomy</li> </ul>

*Table 5: Activity cost above and below \$15 per student*

#### 4.2.2 Activity Interest Level

We evaluated three additional parameters to ensure that the activities that we developed for CSIRO Bootcamps would have high interest to all participants. These areas were:

- Specific activity interest
- Hands-on activities
- Gender preferences

##### *Specific Activity Interest*

The activities that were most interesting were the 3D printed quadcopter, 3D printed bridge, magnetic putty and ferrofluid, phone speaker, and ECG. Two surveys were used to evaluate the activity interest levels. The first survey, described in section 3.2.2, was completed

by peers at WPI to rate activity ideas for interest. The second survey was completed by participants of previous Bootcamps. Figure 6 shows the results of activity interest level based on the peer survey. A focus group with other WPI peers was also held to confirm activity interest. The peer focus group responses, in Appendix K, aligned with the survey results because the activities that received the highest interest in the survey were also the activities that received mostly positive reactions in the focus group.

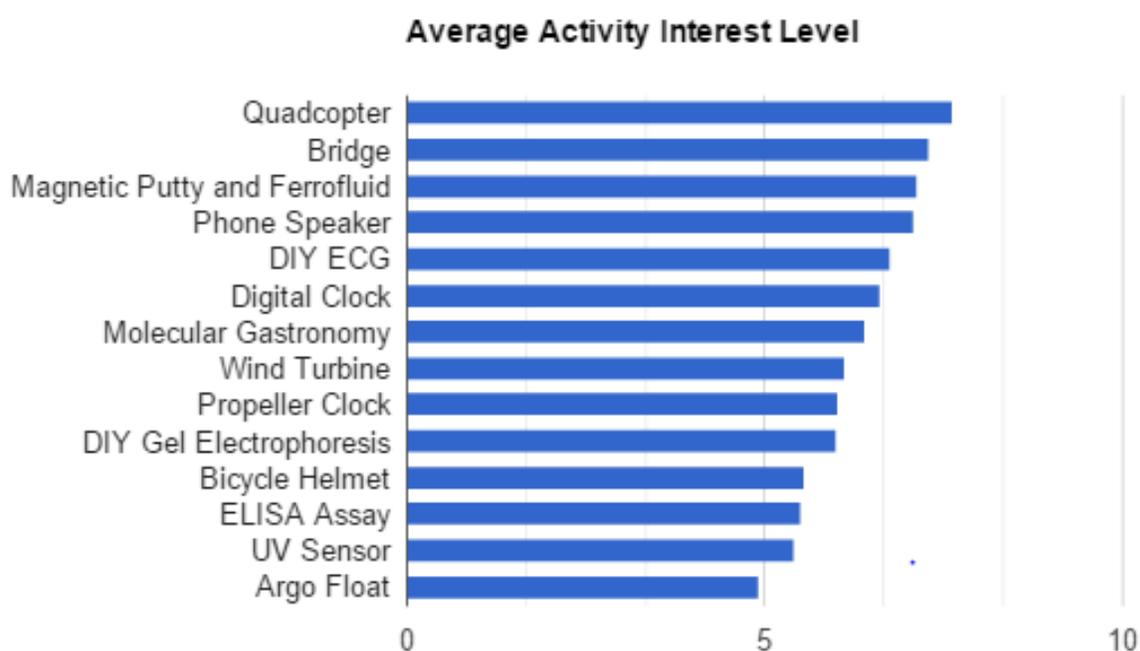

*Figure 6: Potential Bootcamp activity interest levels from peer survey*

The five activities that had the highest overall interest also fit within the subjects that previous science Bootcamp students indicated as most interesting based on analysis of the post-Bootcamp survey. As seen in Figure 7, these subjects were biology, physics, astronomy, chemistry, and electricity.



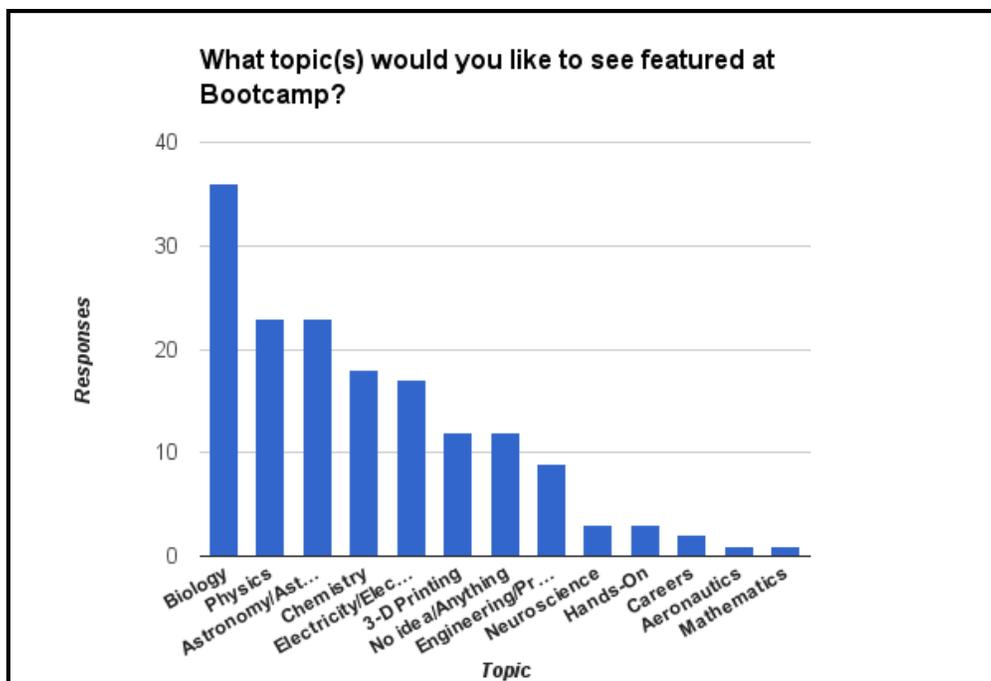

Figure 7: Topics for Bootcamp desired by previous Bootcamp participants

### Hands-On Activities

We determined that hands-on activities were more engaging and would be most interesting to Bootcamp students. This was supported by the focus group with peers from WPI described in Section 3.2.2. This focus group resulted in the data summarized in Table 6.

Positive Aspects of Labs	Negative Aspects of Labs
<ul style="list-style-type: none"> <li>• Hands-on</li> <li>• Closer to Real-World Situations</li> <li>• Easier to Remember Information</li> <li>• “Seeing and doing is better than listening.”</li> <li>• More engaging</li> </ul>	<ul style="list-style-type: none"> <li>• Sometimes the labs are not connected to lectures and students have no idea what is going on</li> <li>• “Don’t really learn better, it’s more entertaining.”</li> </ul>

Table 6: Positive and negative aspects of labs as indicated through WPI peer focus group

All focus group participants preferred labs over lectures indicating that lab work is more engaging and interesting to students. The data gathered from this focus group shown above provides suggestions on how to make lab work most effective. Peers in the focus group specified

that a hands-on aspect of a lab is engaging in itself, but to make lab work educational, it is necessary to ensure the students understand what they are doing and why. Peers suggested that giving students instructions to follow with no background knowledge is ineffective. This information was utilized when choosing our activities for development. We maximized hands-on aspects of the activities so they were more engaging. We also made sure the chosen activities didn't require excessive background information.

### *Gender Preferences*

Based on research and survey results, females prefer biology and chemistry. In addition to subject preference, females prefer activities that have a tie to the real-world (Jones et al., 2000). The results of our activity interest survey conducted among WPI peers support this trend.

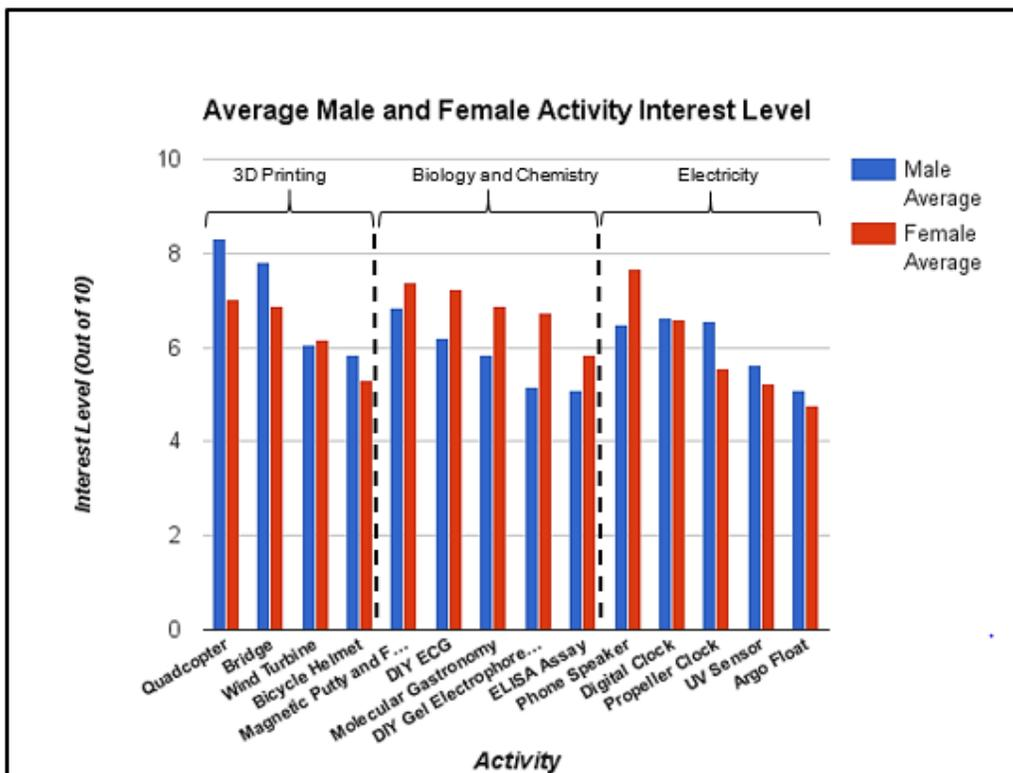

Figure 8: Male and female activity level grouped by subject

As shown in Figure 8, women showed higher interest in all activities related to biology or chemistry. We also see a general trend that males prefer the activities involving 3D printing more than females, except for an almost equal interest for the 3D printed wind turbine. Based on insight from literature, females might have shown interest in the wind turbine activity because wind energy is related to the environment and thus provides a connection to the real-world. There was no significant trend in the activities that involved electricity as interest between males and females was split. The most interesting activity for females overall was the phone speaker activity. This activity fits into the electricity category, so it was unexpected to be the most preferred activity. We conjecture that the high interest level was likely due to the phone being a familiar item that is used every day. In summary, the results support that activity interest increases for females when there is a clear connection to the real-world.

#### 4.2.3 Cross Analysis of Design Principles, Interest Level, and Viability

The activities that were chosen for development satisfied student interest and design principle implementation and were also viable based on safety, cost, and timing. To evaluate design principle implementation, a design principle score was calculated for each activity. This score was based on two factors: the importance score for each indicated design principle that came from the interviews with CSIRO education specialists and the number of design principles an activity could incorporate. To determine the numerical design principle score, the importance score for each design principle an activity could implement were added together. This summation was divided by 6, the number of design principle. The more design principles an activity could incorporate, the higher the score. The interest level score was an average based on the peer survey results. Activities that were viable based on safety, cost, and timing are shown in

green, and the ones that were not are shown in red. The cross analysis of all aspects of each activity is shown in Figure 9.

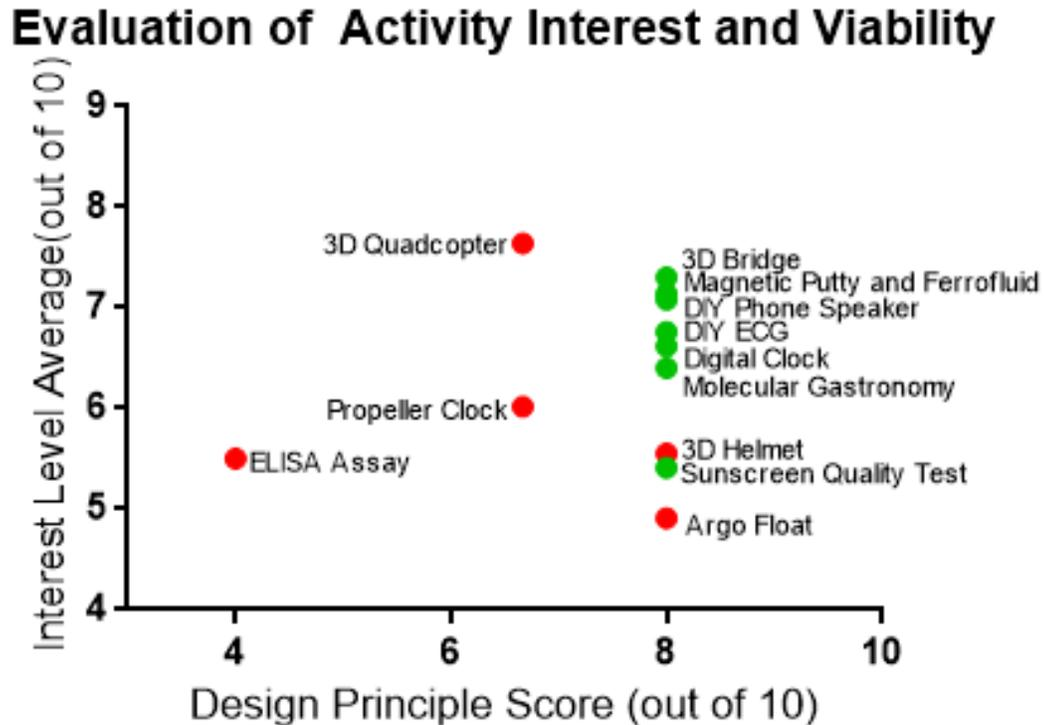

Figure 9: Evaluation of all potential activities based on interest, safety, cost, timing, and design principle implementation- A higher design principle score indicates that an activity better meets the criteria of a successful STEM program

Activities that fall in the upper right corner of the above graph and are also viable (green dots) are the best. The 3D printed bridge, magnetic putty and ferrofluid, the phone speaker, the ECG, and digital clock were the best activities for consideration.

### 4.3 Considerations in the Development Process Specific to Science

#### Bootcamp

The following details our findings on how to develop a Bootcamp activity. These considerations are essential to a successful program. The first consideration is based on analysis

of a post-Bootcamp survey. The remaining considerations are results of interviews with CSIRO education specialists in which we sought advice for developing our activities. The results of all interviews that support each consideration are found in Appendix L.

**1. It was found that new material should be presented but not in a way that requires too little or too much time.**

In order to develop the activities in an appropriate way, we analyzed the opinions of students who attended the previous Bootcamps in the post-Bootcamp survey. We found that students enjoyed having a new topic introduced to them. However, we also found that students disliked having difficulties completing the activity or when they had too much or too little time.

One limitation of the post-Bootcamp survey was that some answers were vague. Students indicated the activity was “interesting,” “fun,” or “boring” but did not explain why. This is shown in Figures 10 and 11. In other survey questions, we found that the survey results were most useful when the students were given answer options along with an ‘other’ category that they could fill in. More insight into better development of the activities could have been achieved with a survey that probes more deeply by including more questions with answer choices. A suggested survey can be found in Appendix M.

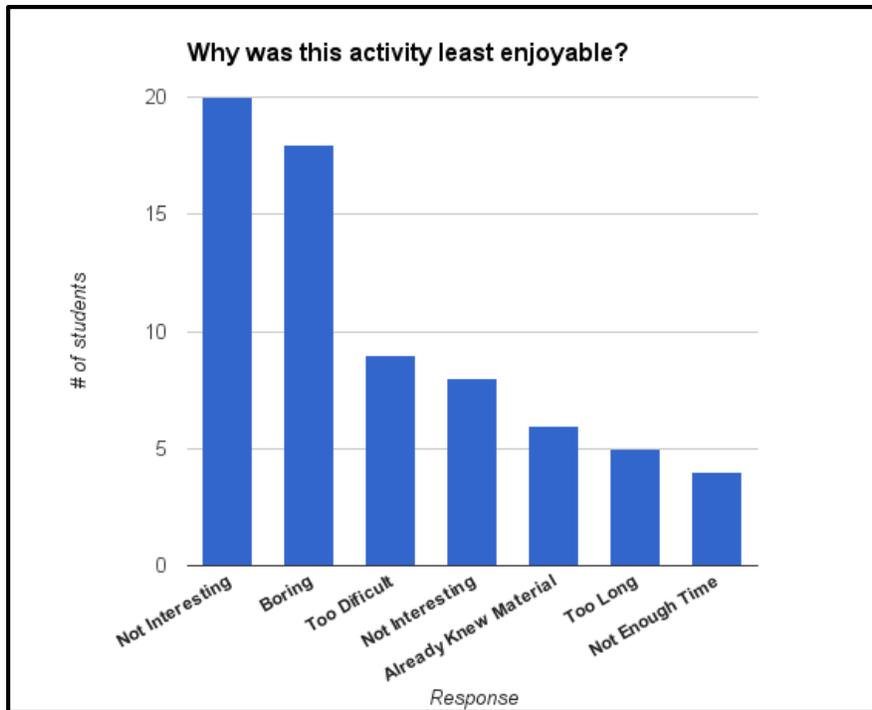

Figure 10: Post-Bootcamp survey results indicating why an activity was least enjoyable

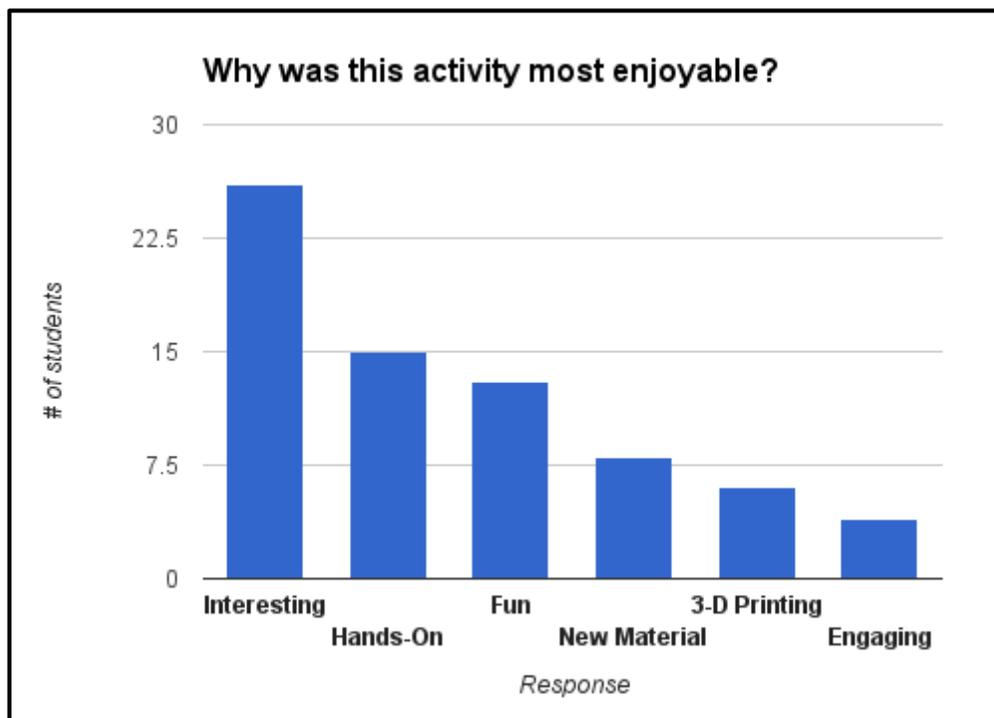

Figure 11: Post-Bootcamp survey results indicating why an activity was most enjoyable

## **2. Necessary background knowledge should be provided to students before beginning the hands-on part of the activity but should be kept to a minimum.**

The students attending Bootcamp have to gain an understanding of the background knowledge before the activity begins because there is a large variation in education levels. One student in our peer focus group stated “it’s important to understand why you’re doing the lab beforehand. Not getting thrown in with nothing. Try to make it clear how each of the steps apply to what the students are working towards.” The interviews with WPI professors and CSIRO education specialists supported this statement as seen in Appendices H and I. One education specialist said that “for most students the context is more important up-front” and that “students need to know what the activity is about.”

It is suggested that students are fully equipped to understand the knowledge needed to follow the instructions and complete the activity. Students should also be given any necessary background information so that they can understand the activity’s key concepts. However, the information given shouldn’t be restricting students’ freedom to think. As one WPI professor states, “give them enough resources to start but also the freedom to take it to any direction they feel appropriate.” Bootcamp should only provide background knowledge that is absolutely necessary for understanding and completing the activity and allow students to inquire about the rest.

## **3. Instructor lecturing should be kept to a minimum and should be presented in an interactive manner.**

The necessary background information needs to be presented, but it has to be limited and interactive. There are two key ways to make lecturing effective:

1. The educator should not do excessive talking

2. During presentation of information, include interactive games, demonstrations, or short activities

By following these considerations, it is easier to keep student interest. Table 7 shows support for this approach to lecturing during an activity that was obtained through interviews with both WPI professors and CSIRO education specialists.

<b>Minimize talking</b>	<p>“Don’t talk too much.” – CSIRO Education Specialist</p> <p>“Keep the talking limited.” – CSIRO Education Specialist</p>
<b>Make Lecturing Interactive</b>	<p>“Make sure the students don’t feel bored by giving them a lot of information.” –WPI Professor</p> <p>“It’s always good, if they can learn things through their own exploration.” – CSIRO Education Specialist</p> <p>“Don’t make it too prescriptive.” – CSIRO Education Specialist</p>

*Table 7: CSIRO education specialist feedback regarding instructor lecturing in a Bootcamp activity*

The knowledge presented to the students should be just enough to get them through the activity. This will give them the freedom to think about the possible explanations of the concepts and to better learn the material. It’s better if the students learn the material through their personal exploration of the subject. Step by step instructions should only be given when absolutely necessary.

**4. The optimal way to begin an activity is by establishing an emotional connection.**

An emotional connection established at the beginning of an activity should elicit feelings that will spark a student’s interest such as curiosity, admiration, surprise, or amusement. Based on interviews with education expert, we found that a good way to do this is by showing the students the final product of the activity. As one CSIRO education specialist indicates, the goal of establishing this emotional connection is to “make their brains think this is cool and make



them think of the goal and then go back on the components of the products.” Adding a surprising fact, video, or demonstration is another way to establish an emotional connection that stimulates student interest.

## **5. Safety is the number one priority.**

CSIRO must ensure that Bootcamp activities are safe. As one CSIRO education specialist stated, “CSIRO is hardcore on health and safety.” If there are parts of the activity are deemed unsafe it is suggested that that part of the activity is removed or completed only by the instructor. “Things that are major safety issues must be done by the instructors. The rest should be done by students,” another CSIRO education specialist stated.

When documenting the safety risks of an activity, the worst-case safety scenario should be assumed. All possible negative outcomes should be considered, avoided to the biggest possible extent and solutions be provided to the instructors. Tasks that involve major safety concerns should be completed by the instructors. If possible, most tasks should be completed by students after eliminating all safety risks. Any part of the activity that has any potential safety hazard for the students that cannot be completely addressed should not be included at Bootcamp.

## **4.4 Activity Evaluation**

After being pilot tested, both the phone speaker activity and magnetic putty and ferrofluid activity are well-suited for CSIRO’s Science Bootcamp. These activities satisfied CSIRO’s requirements for safety, cost, and timing and also had high student interest. The activities were also able to incorporate all six design principles. The aspects of the activity that satisfied each design principle is summarized in Table 8. To find complete descriptions for all parts of each

activity, please refer to Appendix N through X where all the materials for both activities are provided.

Design Principle	Phone Speaker	Magnetic Putty and Ferrofluid
Real-World Relation	- The speaker students build connects directly to the student's own phone or laptop	- The students design an experiment using ferrofluid in order to remove oil from water which is connected to oil spills and helping wildlife
Take Home Item	- The students gets to take home their speaker and a personalized 3D printed case to house it in	- The students gets to take home the magnetic putty they made and their personalized 3D printed case to house it in
Success	- Instructions for completion at home will be provided if students do not finish	- All parts of the activity were tested and proved to be achievable
Challenging	- No step by step instructions are provided (unless a student requires them) so there is a challenge when the student must figure out how to translate the schematic to a workable circuit on the breadboard	- Students must create their own procedure from provided materials
Group Work	- Students work in groups during the amplifier decibel challenge and making of their xylophone	- Students work in groups to design and carry out their experiment
Design and Build	- The students can create a modified speaker design and then build it	- The students design their own experiment from the beginning and then perform their experiment.

*Table 8: Aspects of developed activities that implement the design principles*

We tested our activities for completeness, timing, and how well the design principles were incorporated. Through our pilot tests, we found that it is essential to test activities to determine how long each portion of the activity will take. For example, we found that the actual phone speaker assembly was going to take much longer than anticipated. Because of this, 50 additional minutes were added for completion to ensure student success. The activity had to be

moves to the second day to allow for background information to be presented prior to the activity. Table 9 illustrates the changes in times for each portion of our activity before and after the pilot test. It also shows the change in activity order.

	Minutes	Activity Planned before Pilot Test		Minutes	Activity Planned After Pilot Test
D A Y 1	10	Electricity Overview		20	Sound and Wave Overview
	10	Breadboard, Battery, and Basic Components (Activity)		30	Make your own Xylophone
	15	Reading Circuit Schematics Handout		25	Electricity Overview
	25	Resistor Matching Game		15	Resistor Matching Game
D A Y 2	30	Phone Speaker Assembly		10	Review of Material from Day 1
	30	Sound and Wave Overview		20	Breadboard Practice
	30	Speaker Amplification Challenge		80	Phone Speaker Assembly
	10	Designing 3D Printed Name Plate		10	Designing 3D Printed Case Cover
	20	Make your own Xylophone			

*Table 9: Schedule for Magnet Activity Before and After Pilot Testing*

As the table demonstrates, many changes were made post-pilot test. Any activity that is developed for Bootcamp in the future should undergo pilot testing to confirm timing and order of activities.

## 5. Conclusion and Recommendations

We completely developed two activities that will be offered in 2016 Bootcamps: constructing a phone speaker and using ferrofluids to clean oil spills. Our project also provided CSIRO with a guide for future development of activities that aids in brainstorming, development, and testing. We based these activities and the guide for future development on interviews with experts, focus groups with educators, and surveys of participants in previous Bootcamps. This chapter presents our conclusions and recommendations in five areas:

- Design Principles in STEM Activities
- Interest of Bootcamp Students
- Bootcamp Activity Appeal to Females
- Developed Bootcamp Activities
- Guide for Creation of Future Bootcamp Activities

### 5.1 Design Principles in STEM Activities

In order to have a successful STEM education program, design principles should be implemented to ensure engagement, learning, and motivation. The design principles we developed for Science Bootcamp are:

- Creating a real world connection
- Providing a take-home item
- Ensuring student success
- Incorporating group work
- Including a challenging aspect
- Having both a design and build step

These design principles were determined from interviews with WPI professors who run summer science programs and from research literature on successful STEM education activities. Using interviews with education specialists at CSIRO and research into motivational aspects, we determined how each of these design principles should be included in a Bootcamp activity:

- A real world relation can be achieved by using **analogies or metaphors, visually demonstrating a concept, sharing a surprising fact or connecting the subject to research.**
- Students should **create the take-home item themselves**, because their creation will more effectively remind them of their accomplishments during the activity.
- STEM activities should **offer variations of each task**, resulting in a range of difficulty levels such that all students will feel successful.
- STEM activities should be structured in a way that challenge students by **having an open-ended objective**, but also give students enough resources to achieve the objective. **Additional helpful material should be available** for students who are struggling to overcome a challenging task.
- STEM activities should incorporate **a mix of individual and group activities**. When working on a hands-on task, **the optimal size of a group is between 3 and 5 students**. When learning background theory, **students should be paired up** to encourage discussion and to encourage shy students to voice their opinion.
- STEM activities should include both a design and a build step. The design step should be **prior to the build and the two should be closely related**. Students get more engaged and involved in building something that they designed themselves.

**Recommendation 1: It is recommended that CSIRO Education Staff incorporate the six design principles into activities they develop for Science Bootcamp in the future.** At a minimum, all activities should create a real world connection and provide a take-home item as these were the most important design principles.

## 5.2 Interest of Bootcamp Students

To successfully engage Bootcamp students, we established an understanding of student interest in regards to subject and activity topics and chose which activities to develop based on these interests. Through a peer focus group and survey of our proposed activities, we determined the activities that would interest the students in Bootcamp the most were:

- Phone Speaker
- 3D Printed Bridge
- Magnetic Putty & Ferrofluid
- ECG
- Digital Clock

These activities aligned with the subjects that interested students based on analysis of previous Bootcamp surveys. The subjects that students wanted to see in a Bootcamp activity the most included:

- Biology
- Physics
- Astronomy / Aeronautics
- Chemistry
- Electricity / Electronics

The activities we identified with highest interest fell within one or more of these subject areas. The only subject area not included in the activities was astronomy due to budgetary constraints.

**Recommendation 2: To improve upon the understanding of student activity preferences, CSIRO should utilize a more structured post-Bootcamp survey.** This survey should provide specific answer options with follow-up, open-ended questions to probe more deeply. We provide a suggested Bootcamp activity survey in our guide that focuses on gaining specific answers from the students.

### 5.3 Bootcamp Activity Appeal to Females

To appeal to females, Bootcamp activities should incorporate either chemistry or biology and activities should show a clear relation to a real life impact. To learn how to make our activities more appealing to the female audience, we determined which subjects were of highest interest. Activity interest survey results described in section 4.2.2. as well as our background research described in 2.2.3 indicated that biology and chemistry would be most preferred by females because they have the clearest connection to benefiting society. For example, our magnetic putty and ferrofluid activity demonstrates the societal benefit of cleaning up oil spills with magnets to save affected wildlife.

**Recommendation 3: To attract females to Bootcamp, CSIRO should incorporate biology or chemistry, as well as a real world linkage, in all future Bootcamp activities.** If CSIRO education specialists choose to develop an activity that does not involve biology or chemistry, we suggest that they advertise the activity to emphasize its societal benefits.

## 5.4 Developed Bootcamp Activities

Our project fully developed two activities for use in the 2016 Bootcamp that have been effectively qualified through pilot testing. The first activity is a phone speaker activity and the other is a magnetic putty and ferrofluid activity.

We interviewed CSIRO education experts and gave them a complete description and schedule of our two activities. All interviewees approved of the two activities for Bootcamp and gave suggestions for minor improvements. After editing the two activities, pilot tests were conducted. Based on pilot testing, many changes to the schedules of the activities were made relating to the order and time of each portion of the activity. After final adjustments were made, it was finalized that the phone speaker activity will be used for the January 2016 Bootcamp.

**Recommendation 4: CSIRO should implement the magnetic putty and ferrofluid activity as the second 2016 Bootcamp activity.**

**Recommendation 5: All future Bootcamp activities should undergo extensive pilot testing in order to appropriately finalize the schedule. The best way to conduct a pilot test is a full rehearsal of the activity including presentation of all background information.**

## 5.5 Guide to Creation of Future Bootcamp Activities

To enable the development of future activities, we created a guide that will aid CSIRO in brainstorming and developing activities in the future. The guide includes:

- 1. Design principle descriptions and implementation strategies**
- 2. Brainstorming rubric for evaluation of proposed activities**
- 3. Activity ideas and initial material to begin their development**
- 4. Post-Bootcamp survey**
- 5. Development-stage considerations**

Components 1 and 2 of the guide are based on the design principles we developed as previously discussed. The activity ideas in component 3 are supported by peer survey results that indicated high interest in these activities. Component 4 was discussed previously as we indicated the need for a deeper understanding of student interest. To create component 5, we conducted interviews with CSIRO education specialists during the development of our activities and incorporated feedback from our pilot testing. We found that the development of any future activities should consider the following:

- Bootcamp participants enjoy learning new material, but dislike when the activity is too difficult or doesn't fit the appropriate time.
- The background knowledge provided for the activity should assume the presenters and students know nothing about the subject.
- The optimal way to begin an activity is by establishing an emotional connection.
- Instructor lecturing should be kept to a minimum.
- Safety is the number one priority.
- Pilot testing should be completed in full, including presentation of background knowledge, to confirm timing and order of the parts of the activity

**Recommendation 6: The guide should be used to brainstorm and evaluate activity ideas.**

The guide provides both descriptions of aspects to consider during brainstorming and a rubric to standardize the evaluation of any proposed activity. Because design principles for an activity are not quantitative criteria, the rubric serves to standardize subjective judgments. Educators should use this rubric along with the descriptions in the guide as a tool to discuss the strengths and weaknesses of a proposed activity.

**Recommendation 7: The guide should be used to develop chosen activities.** The revised post-Bootcamp survey results should be used to improve Bootcamp activities to appeal to student



interest. The development-stage considerations should be a top priority when designing and finalizing a Bootcamp activity.

# References

*2013 Teens and Careers Survey. (2013). Junior Achievement USA.*

About Project SEED. (2015). Retrieved November 17, 2015, from <http://www.acs.org/content/acs/en/education/students/highschool/seed/about.html>

*Advancing STEM Education. (2013). Australian Academy of Technological Science and Engineering.*

Appelbaum, P., & Clark, S. (2001). Science! Fun? A critical analysis of design/content/evaluation. *Journal of Curriculum Studies*, 33(5), 583-600.

Archer, L., DeWitt, J., Osborne, J., Dillon, J., Willis, B., & Wong, B. (2012). Science Aspirations, Capital, and Family Habitus How Families Shape Children's Engagement and Identification With Science. *American Educational Research Journal*, 49(5), 881-908.

Bayer Corporation. (2010). *A compendium of best practice K-12 STEM education programs.*

Bell, R. L., Smetana, L., & Binns, I. (2005). Simplifying inquiry instruction. *The Science Teacher*, 72(7), 30-33.

Bloom, B. S. (1984). The 2 sigma problem: The search for methods of group instruction as effective as one-to-one tutoring. *Educational researcher*, 4-16.

Brainard, S. G., & Carlin, L. (1997, November). A longitudinal study of undergraduate women in engineering and science. In *Frontiers in Education Conference, 1997. 27th Annual Conference. Teaching and Learning in an Era of Change. Proceedings. (Vol. 1, pp. 134-143). IEEE.*

Burguillo, J. C. (2010). Using game theory and competition-based learning to stimulate student motivation and performance. *Computers & Education*, 55(2), 566-575.

Center for Teaching and Learning. (2010). Experiential learning defined. Retrieved September 18, 2015, from <http://ctl.utexas.edu/teaching/engagement/experiential-learning/defined>.

CSIRO. (2011). *CSIRO strategy 2011-2015*. Canberra, Australia: CSIRO.

CSIRO. (2012). *Annual report 2011-12*. CSIRO's Annual Report for the year 2011-2012. Retrieved September 18, 2015, from <http://www.csiro.au/en/About/Reports/Annual-reports/11-12-annual-report/Downloads>

CSIRO. (2015a). Highlights of 2013-14. Retrieved September 6, 2015, from <http://www.csiro.au/en/About/Reports/Annual-reports/13-14-annual-report/Part1/Highlights>

- CSIRO. (2015b). Science Bootcamp. Retrieved September 6, 2015, from <http://www.csiro.au/en/Education/Community-engagement/Bootcamp?featured=22C331DBB6EC43EBACA1C42708CAA114>
- DeBacker, T. K., & Nelson, R. M. (2000). Motivation to learn science: Differences related to gender, class type, and ability. *The Journal of Educational Research*, 93(4), 245-254.
- Eccles, J. S. (1983) Expectancies values and academic behaviors.
- Fan, S. C., & Ritz, J. M. (2013). *International views of STEM education*. International Technology and Engineering Educators Association.
- Fasse, B., & Kolodner, J. (2013, April). Evaluating classroom practices using qualitative research methods: Defining and refining the process. In *Fourth international conference of the learning sciences* (Vol. 4, pp. 193-198).
- Felder, R. M., & Silverman, L. K. (1988). Learning and teaching styles in engineering education. *Engineering education*, 78(7), 674-681.
- Feller, R. (2011). Advancing the STEM Workforce through STEM-Centric Career Development. *Technology and Engineering Teacher*, 71(1), 6-12.
- Freeman S., Eddy S., McDonough M., Smith M., Okoroafor N., Jordt H., & Wenderoth M. (June 10, 2014). Active learning increases student performance in science, engineering, and mathematics. *Proceedings National Academy of Sciences (PNAS)*, 111(23), 8410-8415.
- Frey, N., & Fisher, D.. (2010). Motivation Requires a Meaningful Task. *The English Journal*, 100(1), 30–36. Retrieved from <http://www.jstor.org/stable/20787688>
- Goodrum, D., & Rennie, L. J. R. (2007). *Australian School Science Education National Action Plan 2008-2012*. Retrieved from [http://www.academia.edu/1157498/Australian\\_School\\_Science\\_Education\\_National\\_Action\\_Plan\\_2008-2012\\_Volume\\_1\\_The\\_national\\_action\\_plan](http://www.academia.edu/1157498/Australian_School_Science_Education_National_Action_Plan_2008-2012_Volume_1_The_national_action_plan).
- Gough, A. (2014). STEM policy and science education: scientist curriculum and sociopolitical silences. *Springer Science and Business Media Dordrecht*, 446-458. doi: 10.1007/s11422-014-9590-3
- Hannafin, M. J., & Land, S. M. (1997). The foundations and assumptions of technology-enhanced student-centered learning environments. *Instructional science*, 25(3), 167-202.
- Hasan, O. E. (1975). An investigation into factors affecting science interest of secondary school students. *Journal of Research in Science Teaching*, 12(3), 255-261.
- Hernandez, C. (2011). ACS project SEED summer experiences for the economically

- disadvantaged high school students. *56th Annual Report on Research Under Sponsorship of The American Chemical Society Petroleum Research Fund*. Petroleum Research Fund. International student assessment (PISA) - Mathematics performance (PISA) - OECD data. OECD. Retrieved September 20, 2015, from <https://data.oecd.org/pisa/mathematics-performance-pisa.htm#indicator-chart>
- Jensen, F., & Sjaastad, J. (2013). A Norwegian out-of-school mathematics project's influence on secondary students' stem motivation. *International Journal of Science & Math Education*, 11(6), 1437. doi:10.1007/s10763-013-9401-4
- Jones, M. G., Howe, A., & Rua, M. J. (2000). Gender differences in students' experiences, interests, and attitudes toward science and scientists. *Science education*, 84(2), 180-192.
- Kayes, A. B., Kayes, D. C., & Kolb, D. A. (2005). Experiential learning in teams. *Simulation & Gaming*, 36(3), 330-354.
- Kennedy, J., Lyons, T., & Quinn, F. (2012). *The continuing decline of science and mathematics enrollments in Australian high schools*. *TeachingScience*. 60(2), 34-46.
- Knight, Adam. (2015, September 11). *Cancer patient receives 3D printed ribs in world-first surgery*. Retrieved October 3, 2015, from <http://csironewsblog.com/2015/09/11/cancer-patient-receives-3d-printed-ribs-in-world-first-surgery/>
- Kolb, D. A. (2015). *Experiential learning: Experience as the source of learning and development* (2nd ed.) Pearson Education. USA.
- Mehalik, M. M., Doppelt, Y., & Schuun, C. D. (2008). Middle-school science through design-based learning versus scripted inquiry: Better overall science concept learning and equity gap reduction. *JOURNAL OF ENGINEERING EDUCATION-WASHINGTON-*, 97(1), 71.
- Oakes, J. (1990). *Multiplying Inequalities: The Effects of Race, Social Class, and Tracking on Opportunities to Learn Mathematics and Science*.
- Office of the Chief Scientist. (2012). *Mathematics, engineering, & science in the national interest*. Commonwealth of Australia.
- Office of the Chief Scientist. (2013). *Science, technology, engineering and mathematics in the national interest: A Strategic Approach*. Commonwealth of Australia.
- Osborne, J., Simon, S., & Collins, S. (2003). Attitudes towards science: A review of the literature and its implications. *International journal of science education*, 25(9), 1049-1079.
- Pintrich, P. R., & De Groot, E. V. (1990). Motivational and self-regulated learning components of classroom academic performance. *Journal of educational psychology*, 82(1), 33.

- Pfaff, E., & Huddleston, P. (2003). Does it matter if I hate teamwork? What impacts student attitudes toward teamwork. *Journal of Marketing Education*, 25(1), 37-45.
- Ramey-Gassert, L. (1997). Learning science beyond the classroom. *The Elementary School Journal*, 433-450.
- Spangler, S. (2015). Creative science teaching workshop by Steve Spangler. Retrieved from <http://www.stevespangler.com/creative-science-teaching/>
- Upcraft, M. L., Gardner, J. N., & Barefoot, B. O. (2004). *Challenging and Supporting the First-Year Student: A Handbook for Improving the First Year of College*. Jossey-Bass, An Imprint of Wiley. 10475 Crosspoint Blvd, Indianapolis, IN 46256.
- Wigfield, A., & Eccles, J. S. (2000). Expectancy–Value theory of achievement motivation. *Contemporary Educational Psychology*, 25(1), 68-81.
- WPI. (2015). K-12 programs: Frontiers I - WPI. Retrieved September 20, 2015, from <https://www.wpi.edu/academics/k12/frontiers1.html>
- Wurdinger, S., & Rudolph, J. (2009). *Teaching practices that improve student learning: Five experiential approaches*. *Journal of Teaching and Learning*. 6(1), 1-13.

## Appendix A: Interview Questions for WPI Professors

We are a group of students from Worcester Polytechnic Institute in Massachusetts, and we are working with CSIRO to develop new STEM activities for its Bootcamp program. We are trying to determine key design principles that should be incorporated into our activities. This survey/interview is meant for assessment purposes. Your participation is completely voluntary and you may withdraw at any time. All of your answers will remain anonymous. No names or other identifying information will appear in any part of our report.

1. What program did you run or were you a part of this past summer?
2. Could you give us a brief description of that program?
3. What age group was this program targeted towards?
4. Did you come up with this program/ activity?
  - a) How many times would you say you ran through the activity yourself?
5. What factors were taken into consideration other than cost/safety/time when designing the activity?
6. Did the students work together or individually?
7. Was there a take-home message or product from the program?
8. Did you follow any guidelines in creating / running this activity?
9. What parts of the activity do you think were successful? What are you basing this on?
10. What parts of the activity do you think were unsuccessful? What led you to believe this?
11. What aspects engaged the students the most?
12. How much information did you give to the students, and how much did they have to figure out on their own?
  - a) Did you expect the students to have any background knowledge coming in?

# Appendix B: Interviews with CSIRO Education Specialists to Evaluate Design Principles of Activities for Bootcamp

We are a group of students from Worcester Polytechnic Institute in Massachusetts, and we are working with CSIRO to develop new STEM activities for its Bootcamp program. We are trying to determine key design principles that should be incorporated into our activities. This survey/interview is meant for assessment purposes. Your participation is completely voluntary and you may withdraw at any time. All of your answers will remain anonymous. No names or other identifying information will appear in any part of our report.

1. Can you tell us about what you do at CSIRO and what your role in the education programs has been?
2. What activities have you run with high school students?
3. What steps did the activity incorporate along the lines of designing and building?
4. What were the learning objectives?
5. Did the students achieve the learning objectives? How did you assess this?
6. Was the activity successful in educating and entertaining the students?
7. Would you do anything differently if you were to run this program again?
8. When designing an activity, what is the most important goal?
9. What aspects of activities engaged the students the most?
10. Please rate the following design principle on a scale of 1 to 10 based on importance to Bootcamp:
  1. Student Success
  2. Real World Relation
  3. Challenging Aspect
  4. Competition
  5. Take-Home Item
  6. Group Work
  7. Design and Build Step
  8. Small Tasks

## Appendix C: Long List of Activities

1. 3D Printed Bridge Contest
2. 3D Printed Bike Helmet
3. 3D Printed Quadcopter
4. DNA Fingerprinting
5. ELISA Assay
6. Restriction Enzyme Analysis
7. Bacterial Transformation
8. Microarray
9. PCR
10. Circuit Board Stuff (Ex: Radio/ TV remote)
11. Make your own ECG
12. Design your own Propeller Clock
13. Design your own Digital Clock/Watch
14. Make your own Flashlight
15. Cup Speakers: Engineering with Electromagnetism
16. Magnetic Putty and Ferrofluid
17. Molecular Gastronomy (Ex: Ice Cream or Candy)
18. Make your own Stethoscope
19. Lava Lamp
20. Make Medicine (Ex: Aspirin)
21. Argo Float
22. UV Sensor
23. Phone Speaker



## Appendix D: Student Focus Group for Evaluation of Activity Interest

We are a group of students from Worcester Polytechnic Institute in Massachusetts, and we are working with CSIRO to develop new STEM activities for its Bootcamp program. We are trying to determine what activities are most interesting to secondary school students. This survey/interview is meant for assessment purposes. Your participation is completely voluntary and you may withdraw at any time. All of your answers will remain anonymous. No names or other identifying information will appear in any part of our report.

1. Do you like doing labs or listening to a lecture better? What aspects make one better than the other?
2. Of this list of activities, which ones stand out to you based on their titles?
3. Are any of the titles unclear or ones that you have not heard of before?
4. After hearing the activity description, do the same activities still stand out from before?
5. Is there any activity you would want to do that isn't already on our list? Have any of you seen or participated in a hands-on activity that you enjoyed that may be good to add to our list?

# Appendix E: Peer Survey Questions

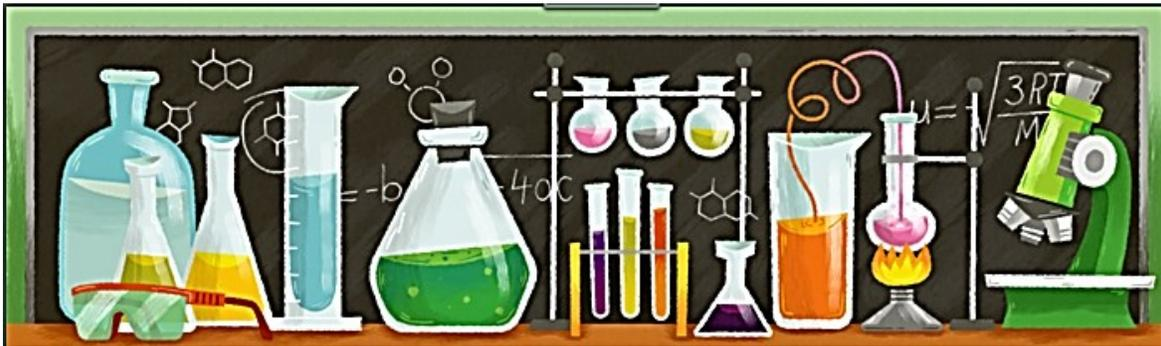

## Activity Interest Survey

Please read the following descriptions of each activity and rate your interest in each on a scale from 1 to 10.

We are a group of students from Worcester Polytechnic Institute and we are working with Commonwealth Scientific and Industrial Research Organization (CSIRO) to develop new STEM activities for their Science Bootcamp program. We are trying to determine which activities are most interesting to secondary school students ages 13-18. This survey/interview is meant for assessment purposes. Your participation is completely voluntary and you may withdraw at any time. All of your answers will remain anonymous. No names or other identifying information will appear in any part of our report.

**Major**

**Age**

**Gender**

### 3D Printing (Bridge)

In this activity, students will design their own bridge with CAD software (TinkerCAD) and create it using a 3D printer. They will learn about several topics in engineering, such as stress analysis, structural systems, and materials science, so they will be able to design their own bridges. They will then crush each of their bridges and gather data, such as maximum force sustained by their bridge, and use this data to design an optimal bridge as a single group.

1 2 3 4 5 6 7 8 9 10

Low Interest ○ ○ ○ ○ ○ ○ ○ ○ ○ ○ High Interest

### ***3D Printing (Bicycle Helmet)***

In this activity, students will design their own bicycle helmet using CAD software (TinkerCAD). They will learn about topics in engineering such as materials science and stress analysis as well as physics to design their own bicycle helmet. The helmets will be tested using pressure sensors for their ability to absorb impacts and to evaluate their use as personal protective equipment.

1 2 3 4 5 6 7 8 9 10

Low Interest           High Interest

### ***3D Printing (Quadcopter)***

In this activity, students will learn basic circuit design and assembly, how to use CAD software (TinkerCAD) to design the body of their quadcopter, and the basics of flight. Students will be able to take their individual quadcopters home with them.

1 2 3 4 5 6 7 8 9 10

Low Interest           High Interest

### ***3D Printing (Wind Turbine)***

In this activity, students will design their own Wind Turbine using CAD software (TinkerCAD). They will learn about topics in engineering such as materials science, energy, and physics to design their own wind turbine. The students will test their turbines and as a collaborated effort will design a super wind turbine to print out and test.

1 2 3 4 5 6 7 8 9 10

Low Interest           High Interest

### ***Argo Float***

In this activity, students will assemble their own Argo Float using knowledge of circuitry and mechanical system design. The float will be used to measure and gather data about the salinity of water in a tank at various points and depths.

1 2 3 4 5 6 7 8 9 10

Low Interest           High Interest

### ***DIY Digital Clock***

The students will learn about circuitry and programming to design and build their own circuit board to power a digital LED clock. The students will also design the housing for their clock in CAD software (TinkerCAD) to be 3-D printed after the Bootcamp session has finished. The students can take home their digital clock and be mailed their 3-D printed housing to put their clock in a few days after bootcamp.

1 2 3 4 5 6 7 8 9 10

Low Interest           High Interest

### **DIY ECG**

In this activity, students will learn about basic circuit design and assembly so that they can assemble their own ECG (electrocardiogram). They will also learn about basic human physiology to understand the functions of the heart. Students will use their ECG to determine their heart rate at several moments such as at rest, after brief physical activity, and after strenuous physical activity. Students will be able to take their ECGs home with them.

1 2 3 4 5 6 7 8 9 10

Low Interest           High Interest

### **DIY Phone Speaker**

In this activity, students will learn about electrical engineering to create an audio amplifier. This will be used to create a portable speaker for their phone. At the end, the students will design and 3-D print a case for their speaker.

1 2 3 4 5 6 7 8 9 10

Low Interest           High Interest

### **DIY Gel Electrophoresis**

In this activity, the students will learn about DNA and each student will be able to extract DNA from both saliva and a strawberry. The students will then make their gel and load the dye with the extracted DNA into it to perform gel electrophoresis. After the gel was run, the students were able to analyze their results.

1 2 3 4 5 6 7 8 9 10

Low Interest           High Interest

### **ELISA Assay**

In this activity, students will work in groups to take a bodily fluid solution and determine the antigen affecting that solution. By adding different solutions to the bodily fluid solution they can determine the substance by the antibodies and color changes that take place. The students can come together as a group to analyze the results and determine what substance was in the bodily fluid.

1 2 3 4 5 6 7 8 9 10

Low Interest           High Interest

### **Fan Clock/Propeller Clock**

In this activity, students will learn about electrical and motor skills to create their own wired LED circuit board attached to a motor. The students will then take the programmed microcontroller and connect it to the motor and circuit board. Applying power to the motor will allow the circuit board to spin, producing an LED clock on the spinning circuit board that students will take home.

1 2 3 4 5 6 7 8 9 10

Low Interest           High Interest

### ***Magnetic Silly Putty and Ferrofluid***

The students will learn about material science to mix together the necessary ingredients with their hands to create their own magnetic silly putty on day 1, and on day 2 will make Ferrofluid. They will then learn about magnetism and be given a neodymium magnet to experiment with their magnetic putty; the students could compete with each other to see whose creation is the strongest. On day 2, the students will manipulate their ferrofluid through a series of experiments involving neodymium magnets and sound waves. The neodymium magnets, putty, and ferrofluid will be taken home by the students.

1 2 3 4 5 6 7 8 9 10

---

Low Interest           High Interest

---

### ***Molecular Gastronomy***

In this activity, students will learn about mechanical engineering to design and build their own extruder. They will learn about molecular gastronomy to mix ingredients that will be fed through their extruders to create a candy product to their designed extruder shape. The students will then take their extruder and candy creation home with them.

1 2 3 4 5 6 7 8 9 10

---

Low Interest           High Interest

---

### ***Sunscreen Quality Test Activity***

In this activity, students will learn about basic circuit design and assembly to create their own UV (ultraviolet) sensor. They will use this sensor to determine the UV index of the sun on a given day and then design an experiment to test the effectiveness of various strengths of sunscreen to determine their effectiveness. The sensor will be taken home and the ability to connect the UV reading to your phone or laptop device will be available using Bluetooth.

1 2 3 4 5 6 7 8 9 10

---

Low Interest           High Interest

---

### ***Comments***

Please comment on what you liked and disliked about any activity above.

### ***Suggested Activities***

Please describe any activities that you think would also be interesting

Submit

# Appendix F: Interviews with CSIRO Education Specialists to Determine Potential Challenges Faced with Chosen Activities

We are a group of students from Worcester Polytechnic Institute in Massachusetts, and we are working with CSIRO to develop new STEM activities for its Bootcamp program. We are trying to determine what potential challenges we might face when conducting our activities. This survey/interview is meant for assessment purposes. Your participation is completely voluntary and you may withdraw at any time. All of your answers will remain anonymous. No names or other identifying information will appear in any part of our report.

1. What is the optimal way of beginning an activity?
  - a) Would it be better to talk about background information first or begin by giving the students a glimpse of our activity?
2. (After a brief description of our activities) What part of each activity do you believe is going to be the most challenging to us?
  - a) Do you have any advice that could help us deal with it?
3. How much help should be offered to the students?
  - a) How much information should be given in the student's procedures?
  - b) What parts of each activity should be done for the student beforehand?
  - c) Are there certain aspects that the professionals should do and not the students?
4. How much time should it take the students to do the activities, based on how long it took us to complete them?

# Appendix G: Focus Group with Peers who Participated in Pilot Test

We are a group of students from Worcester Polytechnic Institute in Massachusetts, and we are working with CSIRO to develop new STEM activities for its Bootcamp program. We are trying to determine what aspects of our activities need to be improved upon. This survey/interview is meant for assessment purposes. Your participation is completely voluntary and you may withdraw at any time. All of your answers will remain anonymous. No names or other identifying information will appear in any part of our report.

1. Did you have fun?
  - a) Why or why not?
1. Were there times that bored you?
  - a) When and why?
1. What did you learn or learn about?
2. What would you do to improve any of the activities?
3. What parts did you not understand or would like further explained?
4. Would you attend this Bootcamp activity?

# Appendix H: Notes from Interviews with WPI Professors

## **1. What program did you run or were you a part of this past summer?**

Interviewee 1: Frontiers

Interviewee 1: Bio Frontiers

Interviewee 2: Frontiers I & II

Interviewee 3: 11 years Frontiers I and past 2 years Frontiers II

Interviewee 5: BME Frontiers I

Interviewee 4: Civil Engineering, Frontiers

## **2. Could you give us a brief description of that program?**

Interviewee 1: Starts each day with a discussion in the morning. It might include a talk about how politics affect science, any interesting fact about crazy science, general public disconnect about science, ect. Real world relations expand their mind.

Interviewee 1: Baby version of an actual course, students find bacteria from soil to make antibiotics, talk about antibiotics, give students a kit to gather samples. Create bacteria colonies, look for areas of inhibitions between colonies to look for antibodies. Organic extraction. PCR. Test the bacteria to determine what kind of bacteria it was. Liquid nitrogen ice cream.

Interviewee 2: 11th and 12th graders to give an intro into Mechanical Engineering.

Interviewee 3: In the morning, lectures. Bring wind tunnel in class. The nicest part is design project. Definitely design, build and flight it. They had to design a glider. 4-Person teams, go in Alden Hall and fly it.

Interviewee 5: Mostly High School students. Biology with Engineering. Teach them some biology and how engineering plays a role.

Interviewee 4: The goal of the program was to give students a sampling of activities that might be involved in civil, environmental and architectural engineering. One professor helped with architecture software. Another faculty did earthquake simulation with a shaking table. You have to determine the strength of the materials. Part of the goal was to show them what the design looks like. Took water out of several locations and investigate it under the lab to see the water quality. Went to several reservoirs around the city.

## **3. What age group was this program targeted towards?**

Interviewee 1: Middle/High schoolers.

Interviewee 1: High school seniors/juniors and rarely sophomores.

Interviewee 2: 16-17 and sometimes 18 years old.

Interviewee 3: High schoolers.

Interviewee 5: Mostly high school students.

## **4. Did you come up with this program/ activity?**

Interviewee 1: Class part of a national initiative, learned from other universities, did not design whole thing but narrowed available content down to fit into Frontiers program.

Interviewee 2: Nope, just ran the pre-existing programs.

Interviewee 3: Yes, I developed it.

Interviewee 5: No, it was a contribution of the department, which has been run for 4-5 years.

Interviewee 4: We have faculty doing research, they commit to disseminate information to younger people, in order to get them inspired.



**a. How many times would you say you ran through the experiment yourself?**

Interviewee 3: Run it once to find obstacles and sticking points. Test it yourself.

**5. What factors were taken into consideration other than cost/safety/time when designing the experiments?**

Interviewee 6: One of the big things in engineering design is safety.

Interviewee 1: Will it be fun and interesting enough to keep students engaged? Try not to do the same thing throughout the program.

Interviewee 2: Wanted to design something using Potential Energy, to convert into Kinetic Energy. Accuracy, device constraints (max height and width).

Interviewee 3: Have them be an engineer at a simple level. We design and build things, we don't just study.

Interviewee 5: How well you can engage the students, 15-18 years old. Want to keep it interesting and at the same time useful. Make it challenging and make them think. Give them real life examples and give them freedom to interpret.

**6. Did the students work together or individually?**

Interviewee 6: Think about how to get the students to answer questions. Have them team up in pairs of two and share the answer so they are then willing to take the risk to answer the questions.

Interviewee 1: Starts individually, but students can choose to pair up. Meant to be individual but can be collaborative.

Interviewee 2: Teamwork, teams of 3-5.

Interviewee 3: They are excited, they might start building on their own. 4-person teams when developing.

Interviewee 5: Work in teams of either 3 or 4.

Interviewee 4: Generally use teams.

**7. Was there a take-home message or product from the program?**

Interviewee 1: Students make a poster with what they learned.

Interviewee 1: Nothing physical, due to safety concerns. Students had disposable lab coats to take home.

Interviewee 2: Printed what students designed in SolidWorks from CAD.

Interviewee 3: There's always something that students take home. In this case, they split the glider.

Interviewee 5: They took home a project that they had to create on their own (modifying crutches).

Interviewee 4: Last couple of years, did posters. Ended up ditching printing the posters. Power points include the poster. If students want, it gets printed and mailed. Give them a WPI USB with stuff from the program.

**8. Did you follow any guidelines in creating / running this activity?**

Interviewee 1: He starts of each day with a discussion in the morning. It might include a talk about how politics affect science, any interesting fact about crazy science, general public disconnect about science, ect.

- My strategy in cases where there is a wide age range, group them by age, group them at different times and based on different categories, sometimes you want them mixed sometimes you don't.

- Constantly change out their group but you have to have different tasks for each group. Make sure that everyone is contributing.

Don't feel the need to be overly topical. You don't have to be super detail specific. The current programs they have are very engineered, don't be afraid to broaden the activity and ideas.

Interviewee 6: Key ideas to think about for engineering design: client user and designer. A lot of times students think ideas just happen, you need to teach the students that there are specific steps that need to be taken

Identify the need, research, develop possible solution, choose best possible, construct a prototype, test and evaluate, ect.

Interviewee 3: Power-point, make it very visual. Show something exploding or breaking.

Interviewee 5: We give the students directions. Different from existing curriculum. Everything was up to them, use computers. Nothing was already given to them Research on their own, within a time limit. There were given some available materials and budget. They were very creative.

### **9. What parts of the activity do you think were successful? What are you basing this on?**

Interviewee 1: Students were good at finding samples.

Interviewee 2: You need the entire program. Tours/Labs/hands-on/teaching. Enjoyed the design greatly. Building was the most fun. More time building, but tweaking the design as they were building.

Interviewee 3: Equally liked designing and building.

Interviewee 5: Based on the feedback, the program was successful because it was hands-on.

### **10. What parts of the activity do you think were unsuccessful? What led you to believe this?**

Interviewee 1: "It's science, stuff doesn't work", "It's 90% failure, 10% success". Usually a small group of students who are just not interested. Behavioral stuff is important to be able to deal with the lower age. Some students just don't listen, thus simply don't deal with the rowdy children.

Interviewee 1: Worms were unsuccessful (part of the activity).

Interviewee 2: Some of the teams had students that didn't participate. Some teams wanted more design time/ less design time. Some teams ran out of design time. Interviewee 2 wanted more teaching time to prepare them better.

Interviewee 5: Don't think anything was unsuccessful.

### **11. What aspects engaged the students the most?**

#### **- Can you give us any advice on how to get students more engaged?**

Interviewee 1: Hit them with the most interesting facts, need a hook, as a 'did you know' type question. Sometimes it does not matter if it connects directly, just try to engage them. An example is that they would go outside on sunny day to set the context when talking about photons.

High use of metaphors and analogies

- "Some people criticize that this dilutes the subject matter. I think the analogies make the subject matter approachable. "
- This helps with long term memory

Many different types of learners

- You need to appeal to all the different types
- Kinesthetic is the most difficult, teaching through motion
- Getting the students up and moving

Change the inflection of your voice

Don't feel the need to be overly topical

- You don't have to be super detail specific
- The current programs they have are very engineered, don't be afraid to broaden the activity and ideas.

Interviewee 6: Competitive aspect makes the students more interested. Make the students ask questions.

Give them something to go off and give them some space to think.

Interviewee 1: Content has real research potential goal, students enjoyed figuring it out on their own for the most part.

Interviewee 2: Enjoyed building the most. Lab tours were great.

Interviewee 3: Make lectures very visual. Show something exploding or breaking. Get them excited to start designing/building.

Interviewee 5: Innovation was the thing that engaged them more, challenged them. Working in teams, they tend to work better as teams.

Interviewee 4: They're not going to learn everything about building bridges in half an hour, but we can take out the key components. There are a lot of social activities. The children are kept active throughout the whole day. "First Monday I can't do something boring, I can't give them a lecture. They need to get engaged straight away".

## **12. How much information did you give to the students, and how much did they have to figure out on their own?**

### **. Did you expect the students to have any background knowledge coming in?**

Interviewee 1: All the little facts are unnecessary as long as you give them the tools necessary. Try to raise the potential of success. Give them some facts but you don't need to give them everything. Feel out the boundaries of the topic. Really stay on the high school level. Audience gauge is important, figure out whether they are getting it or not. Don't focus too much on the background, focus on getting them excited

Interviewee 1: Purposely doesn't give them much, gives enough so students know about necessary content. Showed graphs and data on content, no guarantees it was exciting. Provided more coaching, expected to know much less than actual college students. Students not expected to come in knowing much content, go over basics at the beginning. Basics should be enough to get through it.

Interviewee 2: Provide intro information, but the students had to go deeper themselves. Asked what knowledge they had in a survey and taught from there as a baseline.

Interviewee 3: Assume some high school science, especially physics, is part of their background. Help them while using the software.

Interviewee 5: Everything was up to them, use computers. Nothing was already given to them. Research on their own, within a time limit. There were given some available materials and budget. They were very creative.

Interviewee 4: The background knowledge varies. They're really signing up to learn about it. We assume they know nothing. Typically have some sort of lecture content delivery, but mostly hands-on activities.

# Appendix I: Notes from First Round of Interviews with CSIRO Education Specialists

## **1. Can you tell us about what you do at CSIRO and what your role in the education programs have been?**

Specialist #1: Education specialist. Usually teaching teachers. Worked as a presenter and went to schools to deliver hands on, experiment based programs. Worked with holiday programs as well. Also designed programs: 3 chemistry activities, other holiday programs, and a 3D printing program.

Specialist #2: I am an education officer. Getting science out there in the world. Into peoples' lives, make science relevant in their daily lives. Appreciation why science is important. At the moment works with CSIRO's community outreach. Works with a program called "Sustainable future", which gives teachers resources, lessons, materials on sustainability, agriculture. Involves communicating science with teachers so that they will then reach more students.

Specialist #3: Manages program for aboriginal people in science. CEEdO has a program that takes indigenous Australian people at the end of middle school and give them residential summer school and facilitate scholarships, hoping that they will continue on stem related degrees.

Most of the kids are in mainstream metropolitan schools. Mainly because by the time you get to high school, you have to come in cities or bigger towns. There are no high-schools in aboriginal communities.

Specialist #4: National Bootcamp coordinator. Makes sure the people are actually on the grounds know what to do. Puts together dates, times, venues, the general theme and organizing the activity. Either writes the activities herself or gives it to someone else and then evaluates it.

Specialist #5: Education specialist. Designs future programs. Coordinate schools in QSD. Currently updating new units for this program. Involved in the process of changing the education sector. Ran the DNA extraction Bootcamp.

Specialist #6: Education specialist working on CREST, which is an inquiry based seminar that gets teachers to teach in a more inquiry based way. Also running Bootcamps in holiday camps.

Specialist #7: Works on two projects: sustainable futures, provide teachers with resources that they can use in classroom & inquire to discover: course for teacher for a science classroom. Both primary and secondary school. State funded. Predominantly primary public school.

## **2. What science activities have you run with high school students in and outside of CSIRO programs?**

Specialist #1: Chemistry for all levels, physics on materials and structures looking at trusses and strength, and activities on polymers. Took part in a forensic program, a thinking scientifically program, and activities related to terrariums, archeology, building bridges, and fire.

Specialist #2: Travelling to schools and presenting hands-on workshops. Natural disasters, astronomy, electric circuits (inflatable planetarium), science forensics.

Specialist #3: A lot of activities throughout the years. Too many to go into details.

Specialist #4: Ran all the activities, lab tours and organizes the rest of the programs in Victoria. Other than the Bootcamp, many school-based, curriculum-based activities with secondary school students. Lab tours & presentations with secondary students. DNA activity.

Specialist #5: Quite a lot of work with high school students. A lot with student clubs.

Specialist #6: 3D printing wind turbine and how it works. Using this information to design and test it. Also worked on the GEL electrophoresis. Also things like forensics, food technology and basic chemistry stuff.

Specialist #7: Several school workshops. Provided us with a list of the activities they run, this gives us an idea of what CSIRO is comfortable running. This should also give us an idea of the resources available at our facility. Thinking scientifically, a starting pad about students developing their scientific investigations, how to construct test etc. Coordinated the programs for around 6 years.

### **3. What steps did the science activity incorporate along the lines of designing and building?**

Specialist #1: “Key focus was as much hands on involvement by the student. Things the student could do and do a lot of.” Making it relate to real life. Model a real life scenario. Safety comes before the hands on component. Time and cost.

Specialist #2: Most programs were already designed and built. Something sort of pre-determined that the students had to make, because of the volume of the students. 300 kids would come. “Just because we had a defined amount of time for each activity (each activity about an hour)”. The students wouldn’t have the chance to design because the students had to take something finished home, so that the parents would be satisfied. Sort of open-ended activities that would give more freedom. Occasionally there were extra bits that more advanced students could expand on.

Specialist #3: Curriculum linked. What the teachers had to teach, what we can provide to fill the gaps. Teachers are so packed with curriculum they don’t have time to do extra stuff. Holiday activities give students the chance to try the cool stuff of science. More about engagement and fun activities. “You don’t want to make it really serious”. A lot of people do fun stuff but don’t back it up.

Specialist #4: 3d printing, they had to design the turbine but they had some set parameters. They only designed the blades and there were restrictions on the size. Probably is a good idea to have a structured activity with steps/instructions.

Specialist #5:N/A

Specialist #6: N/A

Specialist #7: Not repeating very similar themes, within about a 4 or 5 year cycle. Decide what we have done in the past. Make sure new material. Cost. Balance of costs between the activities offered at the same camp. Mixing some subjects so that it appeals to a variety of students. “No need to have a girl’s thing”. But it would capture girls’ interest if there was a “biological thing”.

### **4. What were the learning objectives?**

Specialist #1: School ones had to be linked to the curriculum. Useful for the teacher to highlight the points they were trying to hit, worksheets were given to see if they learned and teachers gave

feedback. In Bootcamp: more of a real life learning objective. Example: see value of 3D printing as a prototyping tool.

Specialist #2: A lot of the times there was something to do with explaining energy or some sort of chemical reaction would work or explaining the structure of a molecule. The learning objective didn't drive the activity but usually it was about having a great activity and implement it in a way that a learning objective would grow out of it. Solar powered cars, fixed "science toy". What can we talk about with using them? Electric circuits, sustainable energy, electricity itself maybe.

Specialist #3: It wasn't our role to provide education. They didn't have an option to hold an on-going assessment. They either had 60 or 90 minutes for one-shot of the program. You can understand if the kids were enjoying it. Are they paying attention? "Well, this is very interesting. This makes sense now. This is new".

Specialist #4: There wasn't really a learning objective. We wanted them to come out with a turbine and to get good enough with the program and 3d printing. We told them what they were going to do, but not what they were going to learn.

Specialist #5: There was always a learning objective.

Specialist #6: Normally there was a learning objective of some sort. With the old ones they had to solve a problem or a fixed crime to solve. There was always something they had to solve.

Specialist #7: There's a learning objective set before the activity. Follow template. Key learning objectives. "These are the key questions that we want the students to answer and these are the answers. If students learn these, then you have been successful as a presenter". As long as they walk out knowing these things then you can deem it successful.

## **5. Did the students achieve the learning objectives? How did you assess this?**

Specialist #1: Evaluation form. Base it on the success of their design and final product

Specialist #2: To see whether they achieved it, they measured how many kids managed to build what was asked. This was a consideration that went into the designing of the activity. Is it affordable? Is it achievable by the average x-year old kid? This was part of the design stage. If it was complicated, find a way around it or eliminate the complicated part. Can a group of 30 kids consistently get through activities and finish the construction/activity. Bootcamp should allow you to get into more complicated tasks with similar objectives.

Specialist #3: I'd like to think so for both. Depends on the student/topic. A lot of repeat bookings. Clearly, they were getting something from it. You wouldn't go back to somewhere they didn't have fun. The parental responses were usually pretty fun. In the schools it was a bit more focused. The fun wasn't the first priority.

Specialist #4: With 3d printing, whether they produced the final turbine. With the gel electrophoresis, whether they could create a gel where electricity runs through. The students saw success at a different step and not all of them were successful. We told them that this was real-life when they failed. Worked differently depending on the different site/students/instructor.

Specialist #5: In the classroom, there were a lot of different assessments. Non formal assessment, questioning. Also laboratory skill assessments. Looking to see what students could do, with or without instructors. Lots of questioning with the Bootcamp activities. Success was also measured by whether they successfully created a gel.

Specialist #6: Didn't measure success.

Specialist #7: N/A

## **6. Was the activity successful in educating and entertaining the students?**

### **How did you measure this?**

Specialist #1: Bootcamp: some found it difficult, some found that they learned the stuff before, a lot more variation in responses based on interest compared to school programs

Specialist #2: It usually was, we checked how much they enjoyed.

Specialist #3: Don't really have a lot of data to answer.



Specialist #4: Some enjoyed competing. Some enjoyed designing, some enjoyed building. They enjoyed electrophoresis when they got it right, but it wasn't that much fun.

Side Note: Have a part in the activities that is fun. Something that is cool in the start and in the end. In the middle it doesn't have to be much fun.

Specialist #5: Watching what they were doing. You get an idea or not whether by the questions they are asking. You kind of just gage their responses as you get along. Their feedback at the end.

Specialist #6: Definitely entertaining. The proof of education was whether they actually achieved the goal. Whether they could produce something that was working.

Hands-on what they enjoyed the most.

Specialist #7: N/A

## **7. Would you do anything differently if you were to run this program again?**

Specialist #1: Had too much to do in not enough time took out some tutorial aspects. "Tried to cover too much in the time". Good to have more of a stronger CSIRO Link

Specialist #2: Luxury of repeating/presenting the activity many times. We would come back to the office at the end of the day and we would discuss about the difficulties because "insert something that the students had trouble with". Brainstorm on how to deal with this. Iterate with live audience of students and every time evaluate and try to improve. Active routine of feedback/improvement on the field. Students is different because the volume of students are smaller, it's more of a one-shot (2 of these per year in Melbourne). Try harder to anticipate what the problems would be. It has to be perfect on the day. Roll with any problems and improvise a solution. There were many back and forth discussion on how to get everything perfect for the complex activity (gel electrophoresis). Tried different types of gel. We could let the students go through the process of experimenting, present it as an open-ended. "Hey, this is real science." "Almost like a life lesson". Students in Sydney handled that really well. However, many students would get very disappointed if they didn't get something working. There were plenty whose experiments didn't work. But many got very happy when they managed to make it work.

Specialist #3: N/A

Specialist #4: DNA had too much stuff. Changed some protocols too and also removed one aspect of cutting the gel.

There was not enough hands-on stuff for the second day of gel and it would have been better to get something more cool in the second day. They cannot get bored when they are working.

Specialist #5: A bit too much watch and verbal. Too much in a sequence of them having to copy and do these. Written instructions. I thought it was quite good, because it pushes students to try harder.

Specialist #6: Technology would break down. Access to more 3D printers and better as well.

Specialist #7: Yeah, definitely. We had 14 days to run it, so we could change things while running it. We don't have that benefit when doing the Bootcamp. We are going to get one shot. We need more of a testing phase. We always underestimate how long students take.

## **8. When designing an activity, what is the most important goal?**

Specialist #1: Enjoyment

Specialist #2: Students should have fun (big goal). But this is also equal to the learning objective. It's got to be engaging, novel, fun and quite satisfying to get into. Otherwise if we try to force kids to do something that they're completely uninterested, they're going to get bored and it's going to be hell. Give them something that they'll learn something new in some sort of experiential way. Balance theoretical with practical.

Specialist #3: Constraints with prices. "It has to be pretty cheap, it has to be pretty robust and idiot-proof". It cannot be very complicated. High-achieving and they get really annoyed if they cannot make it to work. Not too easy that is not challenging. The "wow" factor. Something that grabs you.

Specialist #4: Fitting it into time and not have too much lectures. Split it into sections.

Specialist #5: N/A

Specialist #6: You might have an aim in the beginning and you have to make sure that your outcome agrees with your initial focus.

Specialist #7: N/A

### **9. What aspects of activities engaged the students the most?**

Specialist #1: Physically doing something. Both building and designing  
“Doing rather than the listening”

Specialist #2: N/A

Specialist #3: N/A

Specialist #4: The doing is what engages the students the most. This is what should be predominantly what is happening. Actively engaging, i.e. not listening to background stuff. We could have them do a quiz or research something as a group

Specialist #5: N/A

Specialist #6: Anything that is already in the world. Something that is connected to what they do, see or already know. When you get out of the way and let them do it, they enjoy it the most.

Specialist #7: N/A

**10. Have you participated in one of the Bootcamps? If yes, then please rate these aspects of an activity for high school students based on their importance from 1 to 5. 1 being not important and 5 being extremely important.**

Design Principles	Specialist #1	Specialist #2	Specialist #3	Specialist #4	Specialist #5	Specialist #6	Specialist #7
Competitiveness	4	3	5	6	2	3	5
Challenging	7	7	7	8	9	7	7
Students taking something home	9	10	9	9	10	8	9
Group work	8	10	7	6-7	9	7	5
All students completing the task	9	7	8	9	6	9	9
Lots of small tasks	5	8	1	3	1	1	1
Relation to real world	9	9	8	10	10	9-10	7
Design and build steps	5	8	8	6	9	8	6

Design Principle	Quote
Competitiveness	<p><b>Specialist 4:</b> <i>“The rewards should be lame. It should be constructive competition”</i></p> <p><b>Specialist 7:</b> <i>“Some, but not all”</i></p> <p><i>Specialist : Some kids love it, but competition makes some kids really uncomfortable</i></p>

<p><b>Challenging</b></p>	<p><b>Specialist 4:</b> <i>“There need to be levels of challenge. Advanced not bored, slow not disappointed.”</i></p> <p><b>Specialist 2:</b> <i>“It has to be challenging but also attainable. Kids will be so different about what they want to get out of it. You are going to have the top kids (5%) who want to push themselves, the middle majority who want to something that test them a bit but still want to achieve and the bottom group who really want it to be easy.”</i></p>
<p><b>Students taking something home</b></p>	<p><b>Specialist 4:</b> <i>“The parents have to see some kind of result for the money they paid”</i></p>
<p><b>Group work</b></p>	<p><b>Specialist 4:</b> <i>“Make something as a group and then take it individually for the next project. In the wind turbine they worked in teams of 3. Ended up with 10 turbines, where 30 students took part.”</i></p> <p><b>Specialist 5:</b> <i>“Not for the whole time. But there needs to be an element of that. You get some kids who are not so interested, so it does help to pair them up for the learning, enjoyment and motivation.”</i></p> <p><b>Specialist 6:</b> <i>“They don’t enjoy it but it’s important. Mainly they knew they have been slammed together. They have been told they are special and think they are held by other people.”</i></p> <p><b>Specialist 2:</b> <i>“One of the reasons we are the dominant species because of our cooperation. There are introverts and extroverts, it’s a safe space when we can bring them together. You don’t have to be an outgoing sportsy person to work in a team.”</i></p>
<p><b>All students completing the task</b></p>	<p><b>Specialist 4:</b> <i>“90% have to complete, all of them have to get pretty close” “Something that science got wrong, something that they can fix home, something that time doesn’t permit”</i></p> <p><b>Specialist 3:</b> <i>“You cannot have Bootcamp without finishing the project. Everybody gets something finished, but there’s also extension.”</i></p> <p><b>Specialist 2:</b> <i>“You don’t want to set them kids up to fail. But you also want to teach them about the reality.”</i></p>
<p><b>Lots of small tasks</b></p>	<p><b>Specialist 4:</b> <i>“It doesn’t matter the number of tasks, but there has to be some kind of variety”</i></p>

	<p><b>Specialist 1:</b> <i>“depends on what the students are doing”</i></p> <p><b>Specialist 3:</b> <i>“You don’t really need to have small things. People get distracted.”</i></p>
<b>Relation to real world</b>	<p><b>Specialist 4:</b> <i>“It has to be relatable to their everyday lives. They have to understand what use there is.”</i></p>
<b>Design and build steps</b>	<p><b>Specialist 4:</b> <i>“It seems to attract students when we use the word “design””</i></p> <p><b>Specialist 1:</b> <i>“depends on the activity”</i></p> <p><b>Specialist 5:</b> <i>“There was a little bit of them having a choice”</i></p> <p><b>Specialist 2:</b> <i>“With the Bootcamp we have more of the chance to give them a design step. The students entering Bootcamp should have more fundamental skills.”</i></p>

**11. If you had to point to the best aspect of the existing Bootcamp activities what would it be?**

Specialist #1: opportunity for students to do something very similar to what real scientists do

Specialist #2: Access to scientists in CSIRO. This is a big selling point. The fact that we are a real science agency. Go to the labs and talk to real scientists and what they do day by day.

Specialist #3: N/A

Specialist #4: When they kids go “ta-dah”. When they achieve something, figure out something.

Specialist #5: Particularly like the 3D modeling part, where the students got to design and testing their creation.

Specialist #6: Interaction with real scientists at a real center. They are shown the robots, the equipment. Students get to go into the place and see.

Specialist #7: Definitely satisfaction in having completed and taking home something. They want something that they can show to their family and completes their learning. Reinforces their interest, even if it's something very cost-effective. Something that is a bit "showy", particularly for repeat participation in Bootcamps.

**12. If you had to point to the worst aspect of the existing Bootcamp activities what would it be?**

Specialist #1: better instructions and communications for the students. More practiced (more pilot testing). Design and have a go at the scientific process would be good.

Specialist #2: The site-specificness that we have access to. From the point of view, consistency of topics is national. So when are planning our topics and activities, we can have molecular biology tour because some sites don't have it. Reflection of how big and diverse CSIRO is. It's actually a really good thing but gives some constraints our Bootcamp.

Specialist #3: N/A

Specialist #4: Need to work on the balance between on them doing stuff and us giving background lecture / instructions. Broader options of activities. Something that is interesting to the students, not for something that the teachers. Give them options that is outside the curriculum.

Specialist #5: Students sitting and listening, class-room style. Minimalize that.

Specialist #6: Can't think of any.

Specialist #7: Not all students can compete with long periods of sitting and listening. There can be long periods of talking, which makes it important to break it down into parts. Generally, there are always 1 to 2 kinds that have some kind of learning difficulty. "Break things up"

## Appendix J: Primary Criteria for Activity Evaluation

1. Is this activity different from those CSIRO has previously conducted?
2. Is this activity related to CSIRO research?
3. Does this activity interest the Bootcamp coordinators and other STEM experts within CSIRO?
4. Does this activity interest us based on our experience and background knowledge?

	Not done recently	Related to CSIRO	CSIRO interest	Our interest	Overall Rank
1. 3D Printed Bridge Contest	x	x	x	x	4
2. 3D Printed Bike Helmet	x	x	x		3
3. 3D Printed Quad copter	x	x	x	x	4
4. DNA Fingerprinting					0
5. ELISA Assay	x	x			2
6. Restriction Enzyme Analysis					0
7. Bacterial Transformation					0
8. Microarray					0
9. PCR					0
10. Circuit Board Stuff -- (Ex: Radio/ TV remote)	x	x			2
11. Make your own ECG	x		x	x	3
12. Design your own Clock/Watch	x		x	x	3
13. Propeller Clock					
14. Make your own Flashlight	x	x	x		3
15. Cup Speakers: Engineering with Electromagnetism	x	x			2
16. Magnetic Putty and Ferrofluid	x	x	x	x	4
17. Molecular Gastronomy (Ex: Ice Cream or Candy)	x	x	x	x	4



18. Make your own Stethoscope	x			x	2
19. Lava Lamp	x				1
20. Make medicine (Ex: Aspirin)	x	x			2
21. Argo Float	x	x	x	x	4
22. UV Sensor	x		x	x	3
23. Phone Speaker	x	x	x	x	4

## Appendix K: Peer Focus Group Responses

Activity	Positive Comments	Negative Comments
3D Printed Bridge	<p>Initially stood out from the list</p> <p>“3D printing is a good idea”</p> <p>You get the chance to destroy the bridge which is fun</p>	<p>Timing may be difficult</p> <p>Confusing as to which part of the bridge the students would design</p>
3D Printed Helmet	<p>Initially stood out from the list</p>	<p>Not as fun-sounding as the other 3D printing activities</p>
3D Printed Quadcopter	<p>Initially stood out from the list</p> <p>“This is the best one”</p> <p>There is a take home aspect</p>	
Argo Float		<p>Most people did not know what it was based on the name</p> <p>“That sounds incredibly boring.”</p> <p>“Is there another activity where you can watch paint dry?”</p>
ECG	<p>Initially stood out from the list</p> <p>Friends have made one and they liked it</p> <p>The result is very practical</p>	
UV Sensor		<p>Doesn't sound exciting</p>

		Could do a more interesting activity with circuits
Molecular Gastronomy	Initially stood out from the list  “I like it.”	“Don’t know about that”  The extruder part does not seem related
ELISA Assay		Most people did not know what it was based on the name  Really boring
Magnetic Putty/Ferrofluid	Initially stood out from the list  “If you like chemistry, it’s a lot of fun.”	Can go horribly wrong if spilt
Propeller Clock	Really cool	Sounds difficult
Digital Clock	The design is cool	The actual clock is not too exciting
Phone Speaker	Is more simple than some of the other electrical design activities  Could incorporate 3D printing as a case for the speaker  Connects to a phone	

# Appendix L: Notes from Second Round of Interviews with CSIRO Education Specialists

## 1. What is the optimal way of beginning an activity?

### a) Would it be better to talk about background information first or begin by giving the students a glimpse of our experiment?

Specialist #1: Address safety concerns. Electricity, chemical or particular processes they have to be aware of. Better tell them less about what to do, encourage them to read instructions. “What is the activity about?”. Show them any new equipment. Safety, context and important knowledge. Start with background information, so that students know what it’s about.

Specialist #2: Surprise, relevance, challenge. Each of those things to some extent needs to be multi-way. In terms of relevance, that could be from connection to x-factor or something we know is a problem to people. “What can this do for you?”. Or like a theme, “world hunger?”. Surprise to hook their attention. The reason these things matter is that they all offer an appeal to an emotional level. Science communication starts with a smile not a statistic. Start with something people will have a personal connection with. Don’t make it too prescriptive. Science teaching is not an emotion-free world. How the students respond to, what they feel.

Specialist #3: Lay off with an exciting demo or this is what we’re making or some theory to put it all in context. If they’re making a thing, start with context. Create a bit of narrative around the context. And then link it and get them to do some stuff. Don’t talk too much.

Specialist #4: Demonstration as they come into the room. Visually appealing demonstration. Make their brains think this is cool and make them think of the goal and then go back on the components of the products. “I like a glimpse of the activity. Some sort of reason and interest to the context.”

Specialist #5: A good way to start is an explanation of what we’re going to do and safety. An introduction of the activity, a bit about understanding what they already know, Q&A, background, safety. We can show the final product. It’s always good to have the physical object or pictures. Background info first.

Specialist #6: It’s always good, if they can learn things through their own exploration. Laid-in activity and experiment. If they can learn themselves, that’s the best thing. If it’s a difficult thing or tricky, have a model. Steps can be useful too. Some can see the diagram, others can ask,

others want to see it working. Try to cater for different learning styles. We can start with some kind of video, or even lecture.

**2. What part of each experiment do you believe is going to be the most challenging to us?**

**a) Do you have any advice that could help us deal with it?**

Specialist #1:

Speaker) First about safety, sharp wires, battery. Soldering for example. Fairly likely to stab themselves with something hot. Software difficulties. Templates and have them add stuff. There have been issues with computers connecting to internet and etc. There might be technical issues. Use TinkerCAD. It would be great if they could take both items with them. Do it like the dog tag. It means that it will not take over the activity. They could also leave what they want if they don't manage to do it. Really like the idea of using what they made the first day and experimenting.

Magnetic Putty) Very messy but good fun (referring to ferrofluid). Safety. Very specific about handling it. That activity will take a lot of management. With the little magnets we have to check of the liability of giving them the small magnets home. If a pet, young sibling eats it, CSIRO can be a problem. Stick it to a stick to make it into a bigger object or stick a VERY BIG safety note.

Specialist #2:

Speaker) The upside of building the case is that it's a cool thing. Downside is that it uses up a lot of time and you lose focus of the sound/electricity part. Wouldn't want to lose electronic-part. Partly for the people who are very good at it. It will become too much of a fun thing. "It's a tricky battle". Go to the corner part for 5 minutes. It has to be on the first day. "Amazed how many times people believe the students will do that. You cannot run away, you got to fix that!" Precise in your mind, honest in your application. Time limit problems. We can set them limits.

Slightly brilliant idea: Soldering iron set up in a space and components, maybe a computer or 2 perhaps. Set up TinkerCAD. The same template and a choice of an X numbers of symbols. A very quick process and it's still part of the progress. Pre-print the boxes. Fair amount of time. It's not a terrible idea. Buy some time out of the exciting but useless parts.

Magnetic Putty) *CSIRO-FLOCK (not certain)*, supposed to be a method of cleaning industrial spills. Magnets and iron oxide. Pull magnet and water looked clean. Pass liquid through a magnetic field. And then filter out. Which way are they cleaning the oil? Pushing it towards some way or attracting it to a certain point. Pros/cons of different combinations and different techniques. Push the magnet across the spill. There has to be a technique. See if CSIRO works on oil spills. Wouldn't be surprised if we found any modelling.

Problems: not knowing the audience. People do actually feel better with placebos. Glasses, gloves, masks and aprons. Need to put down something on the surface and the tray. More of a home-maintenance thing rather than safety.

Limited access, limited quantity, the process is supervised, instructions are provided and safety equipment is used. What can we do to make things safer? The very last thing is PPE. When you finished, gloves go to the bin and you wash your hands immediately! Likewise they should be given a sticker on the container and maybe a separate card with safety instructions. A sticker on top. A sticker on top of what they students take away. Are they going to get poisoned, are they going to get electrocuted. “Think like the idiot, think like the obsessed nerd. Careless, over excited and obsessed.”

Be hardcore about health & safety. Search for the problems, search for the answers and report all of them.

Specialist #3:

Speaker) If the point is teaching them 3D printing and TinkerCAD, give them time. If it’s not their focus, we can just have it cycle through making a “dog tag”. Make them excited. Show it working. Don’t wait till the end. Show it early.

Preferably do the activity sheets on the PowerPoint, step them through it. Don’t give them a sheet with calculations. Maybe talk them through it. We’ll get through this. Start by showing them the speaker. “Be human”.

Magnetic Putty) There is still a lot of semi-hysteria out there about ferrofluid. If it looks like we’re giving people something that is not fully enclosed. We got to be really careful about the safety. Set up ferrofluid to do kinetic stuff around metallic other stuff. Careful, it’s really messy!

Specialist #4:

Speaker) Show a demonstration of sound properties by using the speaker. The actual plan is totally fine. Make it into a competition. Have them apply towards a goal. Find something that involves them standing up and doing an activity as a group. Graphite on a piece of paper. Something silly like create a giant resistor, stick them. Have them in groups. Get them thinking about resistor colors. Competition aspect.

Magnetic Putty) You can’t give them a card blank “Design this process”. We need to have a certain number of parameters. Rather not give them commercial ferrofluid to take at home. Still thinking about the suspension liquid. They did use ferrofluids in the past. Not a fan of letting them take ferrofluid at home. Risk of culture, we can’t do it, no. Start with glue. Start making silly putty, explain them iron oxide. Make it magnetic. About oil spill: it’s fine to use time to design experiment.

Specialist #5:

ECG) Concerns about the wiring bit. Teaching them the circuitry.

Phone Speaker: Again the circuitry. TinkerCAD won't be very difficult.

Magnetic Putty) TinkerCAD might be difficult, if they have to design the whole thing.

Digital Clock) Concerns about the circuitry.

3D Printed Bridge) Difficult to get together as a group and agree on design aspects.

Specialist #6:

ECG) They'll love collecting data. Problems with downloading software, or laptop problems. Technical issues. Think about dissecting hearts. Check equipment and permissions. Maybe virtual.

Phone speaker) It's a bit trickier if all students need TinkerCAD on their computer. MAC and PCs could be a problem too. There were no technical issues like that during the wind turbine.

Magnetic Putty) Could they make different kinds of putty and check different effects? They could try each of the three bleach, detergent of liquid starch. They could also use different concentrations of iron oxide. Changing a variable and conducting experiments.

Propeller Clock) Visual, oral explanation.

3D Printed Bridge) Same issue with the 3D printing. 20 prints overnight might not be done. It relies too much on the 3D printing. If this goes wrong, we don't have a backup.

### **3. How much help should be offered to the students?**

- a) How much information should be given in the student's procedures?**
- b) What parts of each activity should be done for the student beforehand?**
- c) Are there certain aspects that the professionals should do and not the students?**

Specialist #1: Definitely recommend detailed instructions. Very clear step by step process.

Previous Bootcamp only gave out instruction cards. Anything that will help the activity be quicker if time is critical. Have materials pre-laid out. Anything that could seriously hurt the students, do it for them. Most of it have them do it themselves. If the process doesn't take too long, it's okay. Otherwise, prepare it beforehand. If there is like a big container of iron oxide, we can't have students coming up one by one and getting their own.

Specialist #2: N/A

Specialist #3: Pretty prescriptive. A specific thing requires a recipe. Up to us to give them the schematics and tell them "go for it". Either put it up, or have print outs of the photo.

Alternatively, schematic and a sheet with a photo next to its symbol. Have EVERYTHING available to the staff. Have extra things in case students are pretty fast. Have stuff we can ditch.

Think about the first thing we went through the process. The actual making will take longer than we do. Give them double time, have extra stuff for the people who finish in the same time as we do.

Specialist #4: Limit the materials. Make some suggestions about what they should be thinking. Give them couple of materials. In theory, all students should design the same experiment. Time-limit, number of materials, possible apparatus, tips and tricks. Sheet of some sort that they have to fill in. There should be a template that they have to fill in. Need to over how to perform an experiment. There's this, now start learning. Pairs of 3s. Tell you when you have the experiment ready. Can't have them solder a lot. As far as she knows, we don't need safety masks. Gloves. Plastic aprons. Lab coats.

Specialist #5: We would have to show them, demonstrate and also have written instructions. How much help should be offered: As much as they need. How much information given vs figure out: All the information given. Step by step, straightforward. Not if they have to design something themselves. Only things that are major safety issues must be done by the instructors. The rest should be done by students. It needs to be longer than it takes us to complete the activity. This might be the first time that they complete or see the activity. Times 1.5 maximum.

Specialist #6: Have a backup, in case something goes wrong. They could be doing material testing and then make hypothetical builds. Maybe they could print little models of them. Would be more inclined to build a model of the builds. We cannot guarantee that the industrial printers will be free at the day of the Bootcamp. We have to give them help. Again, what do we want the outcome to be? Do we want them to follow procedures? "I think I did it right, but it's not working". Or "you need to get from this to this, experiment. See what happens". For circuits, full diagram. One wire in the wrong spot, nothing working. Put the information, such as resistors and capacitors in a take-home booklet. In the instructions for the next few hours, put it simply. We should provide the info in the background lecture. It really is case by case. We could have printed all the bases in advance. Do everything for magnets on the spot. Have actual numbers. Depends on time and safety. It all comes down to these two aspects.

#### **4. How much time should it take the students to do the activities, based on how long it took us to complete them?**

Specialist #1: Double it. They start to chat, they don't pay attention, they take time to read. At least 1.5.

Specialist #2: N/A

Specialist #3: Have extra things in case students are pretty fast. Have stuff we can ditch. Think about the first thing we went through the process. The actual making will take longer than we do. Give them double time, have extra stuff for the people who finish in the same time as we do.

Specialist #4: N/A

Specialist #5: It needs to be longer than it takes us to complete the activity. This might be the first time that they complete or see the activity. Times 1.5 maximum



Specialist #6: At least 1.5 to 2 times as long. Because we have to cater for the slowest kids in the group. Get the fastest students to help others. Have the base printed out and mail the top afterwards, potentially with their names on it.

Appendix M: Bootcamp Guide

# Guide for the Creation of Bootcamp Activities

Created by:

Rachel Connolly

Adam Gatehouse

Georgios Karapanagos

Matthew Portugal

December 2015



## Table of Contents:

1. Design Principles for Implementation in Activities
2. Brainstorming Rubric
3. Additional Activity Ideas and Materials
4. Post-Bootcamp Survey
5. Development-Stage Considerations

## 1. Design Principle for Implementation in Activities

These design principles are necessary to any successful STEM program. They were specifically extracted for implementation in Science Bootcamp, but the reasons why they are important and how to implement them can apply to any STEM program.

<b><u>Design Principle (In Order Of Rating)</u></b>	<b><u>Why It's Important</u></b>	<b><u>How to Implement</u></b>
Real World Relation	<ul style="list-style-type: none"> <li>- Adds relevance to the topic which motivates and engages students.</li> <li>- Adds a CSIRO connection, which provides a link to potential future career opportunities.</li> </ul>	<ul style="list-style-type: none"> <li>- In presentations model a real life scenario, blow their mind, and present real-world concepts that parallel the activity.</li> <li>- Show the real-world application through demonstrations.</li> </ul>
Take Home Item	<ul style="list-style-type: none"> <li>- Satisfaction in having completed something</li> <li>- Acts as a reminder of Bootcamp every time they see or use it</li> <li>- Students learn better when they demonstrate their learning</li> </ul>	<ul style="list-style-type: none"> <li>- Student takes home something he/she created at Bootcamp.</li> <li>- If the object isn't tangible, it could be as simple as a USB with a CSIRO logo and a printed/digital poster with what they learned at Bootcamp.</li> <li>- Include information for further investigations after Bootcamp is over.</li> </ul>
Student Success	<ul style="list-style-type: none"> <li>- Students' interest in STEM depends on whether they feel successful when participating in the activities.</li> <li>- Students will become demotivated if they feel incompetent of completing the activities.</li> </ul>	<ul style="list-style-type: none"> <li>- Students should be rewarded for their efforts and additional help should be given to students who are struggling.</li> <li>- Extra instructions can be given to students who didn't complete everything during Bootcamp so that they can continue building at home.</li> <li>- Teach students that practicing STEM involves failing many times, gaining knowledge from your failure and repeating until you achieve success. Failure is a necessary component of practicing science, not a lack of student ability.</li> </ul>
Challenging	<ul style="list-style-type: none"> <li>- You do not want to bore the top students in Bootcamp.</li> <li>- Challenging students, but providing helpful tools helps them achieve a sense of accomplishment when they succeed.</li> </ul>	<ul style="list-style-type: none"> <li>- Provide a challenge in the activity that can be overcome.</li> <li>- Provide a step by step procedure for students who may want it, but let the most students try to figure it out themselves.</li> <li>- Give the students a task that cannot be completed in Bootcamp which can be finished after to enhance their take-home item.</li> </ul>

Group Work	<ul style="list-style-type: none"> <li>- Group work enhances student learning, motivates students and increases enjoyment levels.</li> <li>- When there are too many students in a group, some might not get engaged.</li> <li>- When there are too few students in a group, some might get overwhelmed and give up on the task.</li> </ul>	<ul style="list-style-type: none"> <li>- Interchange between individual activities, group activities and different group sizes.</li> <li>- The optimal size for hands-on activities is between 3 and 5 students, depending on the nature of the task.</li> <li>- When learning background theory and answering questions, students should be paired up. This will help shy students voice their opinions.</li> </ul>
Design and Build	<ul style="list-style-type: none"> <li>- Learning by design encourages engagement, reflection, and case-based reasoning.</li> <li>- Building is the most fun to the students and building their own designs are even more engaging.</li> <li>- Gives the more advanced students a chance to expand on the activity.</li> </ul>	<ul style="list-style-type: none"> <li>- Students prefer the build aspect, but to get students engaged in background knowledge they should design their own parts of the activity.</li> <li>- Even giving the choice of different pre made designs adds a more personal touch for the students.</li> </ul>

## 2. Activity Brainstorming Rubric

This rubric can be used to brainstorm STEM activities that would be best to implement in CSIRO's Science Bootcamp Program.

Activity Name: \_\_\_\_\_

Proposed by: \_\_\_\_\_

Date: \_\_\_\_\_

### Description of Activity

---



---



---



---

### CSIRO Connections

1. \_\_\_\_\_
2. \_\_\_\_\_
3. \_\_\_\_\_

### Design Principle Integration

Design Principle	3	2	1	0
Real World Relation	There is a clear real world relation that can be explained through an analogy or metaphor, be connected to real research and be a demonstration.	There is a clear real world relation that can be explained through either an analogy or metaphor, be connected to real research or be a demonstration.	The real world connection has to be explained in order for students to see the connection to the activity.	There is no possible real world connection.
Take Home Item	There is a tangible item that the student has created during the activity and can take home.	There is a tangible item for the students to home that relates to activity, but they did not create it.	There is a tangible item for the students to take home, but it does not relate to the activity.	There is no possible take home aspect.
Success	There is a good chance that all students will complete the activity, and if not, there is a way for them to complete the activity on their own.	There is a good chance that all students will complete the activity.	It is expected that some students will be able to complete the activity, but there are many variables that	There is no possibility of student success.

			could prevent success.	
Challenging	The activity is challenging but the challenging aspect can be adjusted through provided materials to adjust to student ability.	The activity is challenging but there are no variations.	The activity is only somewhat challenging.	There is no possible challenging aspect.
Group Work	Group work and individual work can both be incorporated into the activity. Groups can be 3 to 5 people and there are opportunities to switch groups throughout the activity.	Group work and individual work can both be incorporated into the activity but groups have to be more or less that 3 to 5 people and have to stay the same throughout the activity.	Group work can be incorporated but there would be no chance for individual work.	There is no possible way to incorporate group work.
Design Step and Build Step	The students design part of the activity and then build based off of their own design.	There is both a both design and build step however they do not connect.	There is either a build or design step but not both.	There is no way to integrate a design and build step.

**Overall Score: \_\_\_\_\_**

**Safety**

Safety Concerns	Potential Solutions

**Are there any aspects of this activity that are unsafe and have no way to avoid? Yes/No**

## Time

Bootcamp activities must be 90 minutes on the first day and 120 minutes on the second day. Fill out the following schedule with preliminary ideas to make sure the activity can fill the require time without being too long.

Day 1 (90 mins)	Activity Plans	Day 2 (120 mins)	Activity Plans
0-10 mins		0-10 mins	
10-20 mins		10-20 mins	
20-30 mins		20-30 mins	
30-40 mins		30-40 mins	
40-50 mins		40-50 mins	
50-60 mins		50-60 mins	
60-70 mins		60-70 mins	
70-80 mins		70-80 mins	
80-90 mins		80-90 mins	
		90-100 mins	
		100-110 mins	
		110-120 mins	

**Does the activity have the potential to fit within this time frame? Yes/No**



**Cost**

Material	From Where	Estimated Cost

**Does the activity cost less than \$15 per student? Yes/No**

### 3. Additional Activity Ideas and Materials

The following are activities that could be used for Bootcamp activities in the future or for other STEM programs CSIRO runs.

- 3D Printed Bridge Competition
- Make Your Own Electrocardiogram
- Make Your Own Digital Clock
- 3D Printed Quadcopter

#### 3D Printed Bridge Competition

The 3D Printed Bridge Competition is an idea adapted from a successful summer program offered at Worcester Polytechnic Institute. This activity would involve students design a bridge that would be 3D printed. The students would then test the bridges to see which design is strongest.

Topics examined:

- Civil Engineering
- Stress Analysis
- Mechanical Failure
- 3D modeling and printing
- Materials testing

<b>Design Principle</b>	<b>How it was implemented</b>
Real World Relation	- Relates to research in 3D printing technology - Relates to prominent engineering landmarks - Poses students with a real world engineering problem - Introduces students to engineering techniques and practices
Take Home Aspect	-Students can design additional 3D printed items for CSIRO to print and send them - Students take away knowledge of engineering practices and equipment
Success	- All the students will succeed in designing a bridge as a team with help from instructors
Challenging	- Students are tasked with a challenge, designing the strongest bridge
Group Work	- Students form teams to decide how to design their bridge - Students work together to model their bridge in CAD software
Design and Build	- Students use knowledge acquired in Bootcamp to design their bridges and them build them

Pros	Cons
<ul style="list-style-type: none"> <li>- Incorporates all of the design principles</li> <li>- Allows CSIRO to show its 3D printing capabilities</li> <li>- Allows CSIRO to show its materials processing and testing capabilities</li> <li>- Introduces students to real world engineering practices, techniques, and equipment</li> </ul>	<ul style="list-style-type: none"> <li>- Too dependent on a single 3D printer</li> <li>- Would need support activities to supplement this activity</li> </ul>

The following is an example for the modeling and testing of the 3D printed bridges.

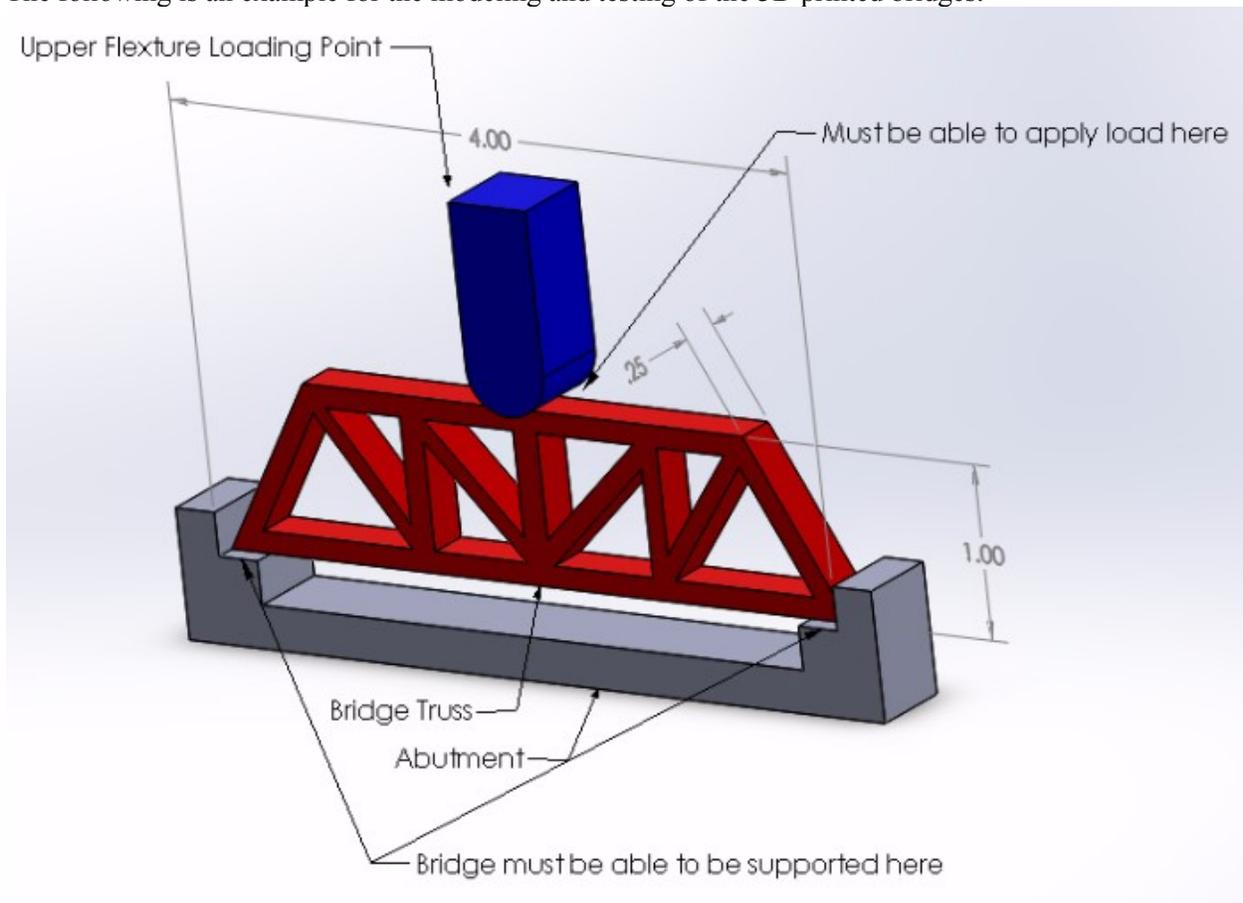

### Make Your Own Electrocardiogram

This activity would begin by students creating their own ECG with circuitry. The second part of the activity would involve learning about the heart and doing physical activity to make observations about how the heart beat changes with exercise. Students could also learn about differences between the wave forms of a normal heart beat and abnormal ones.

Topics examined:

- Electronics
- Electrical circuits
- Biology
- Biotechnology
- Biomedical engineering
- Electrical engineering

Design Principle	How it was implemented
Real World Relation	- Introduces students to personal electronics - Introduces students to biotechnology and its applications - Students can measure their own heart beat
Take Home Aspect	- Students build their own electrocardiogram which they will get to keep
Success	- Step by step instructions for the creation of the circuit with pictures would be provided
Challenging	- Students are tasked with developing a technology which is used in a professional setting
Group Work	- Students can work in small groups to assist each other in constructing and testing their circuits
Design and Build	- Students can design an experiment to test how exercise affects the heart

Pros	Cons
<ul style="list-style-type: none"> <li>• Incorporates all design principles</li> <li>• Would have high appeal to females</li> <li>• Explores topics in STEM not typically associated with each other by combining electricity and biology</li> <li>• Can adapt material from Make Your Own Speaker activity from January 2016 Bootcamp</li> </ul>	<ul style="list-style-type: none"> <li>• Complex circuitry</li> </ul>

The following are circuit diagrams of an electrocardiogram. One is more complicated and one is a simplified version.

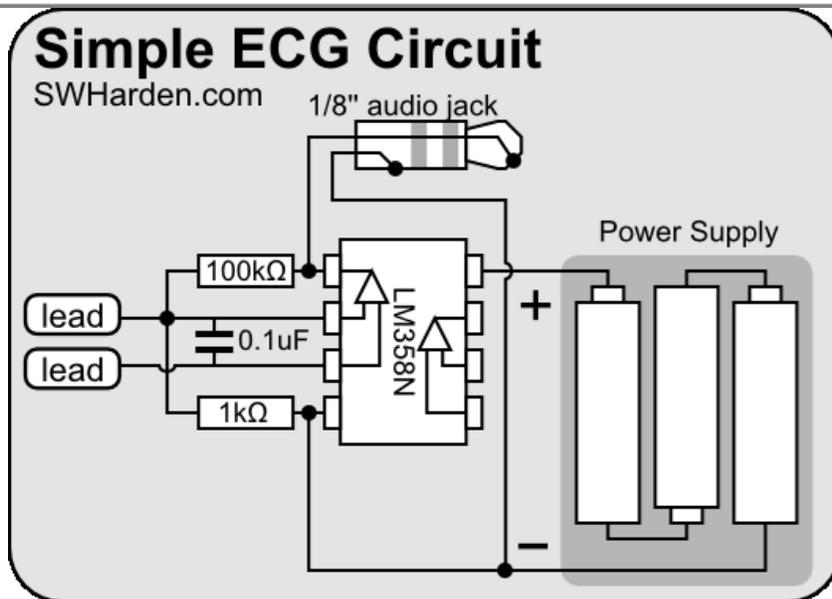
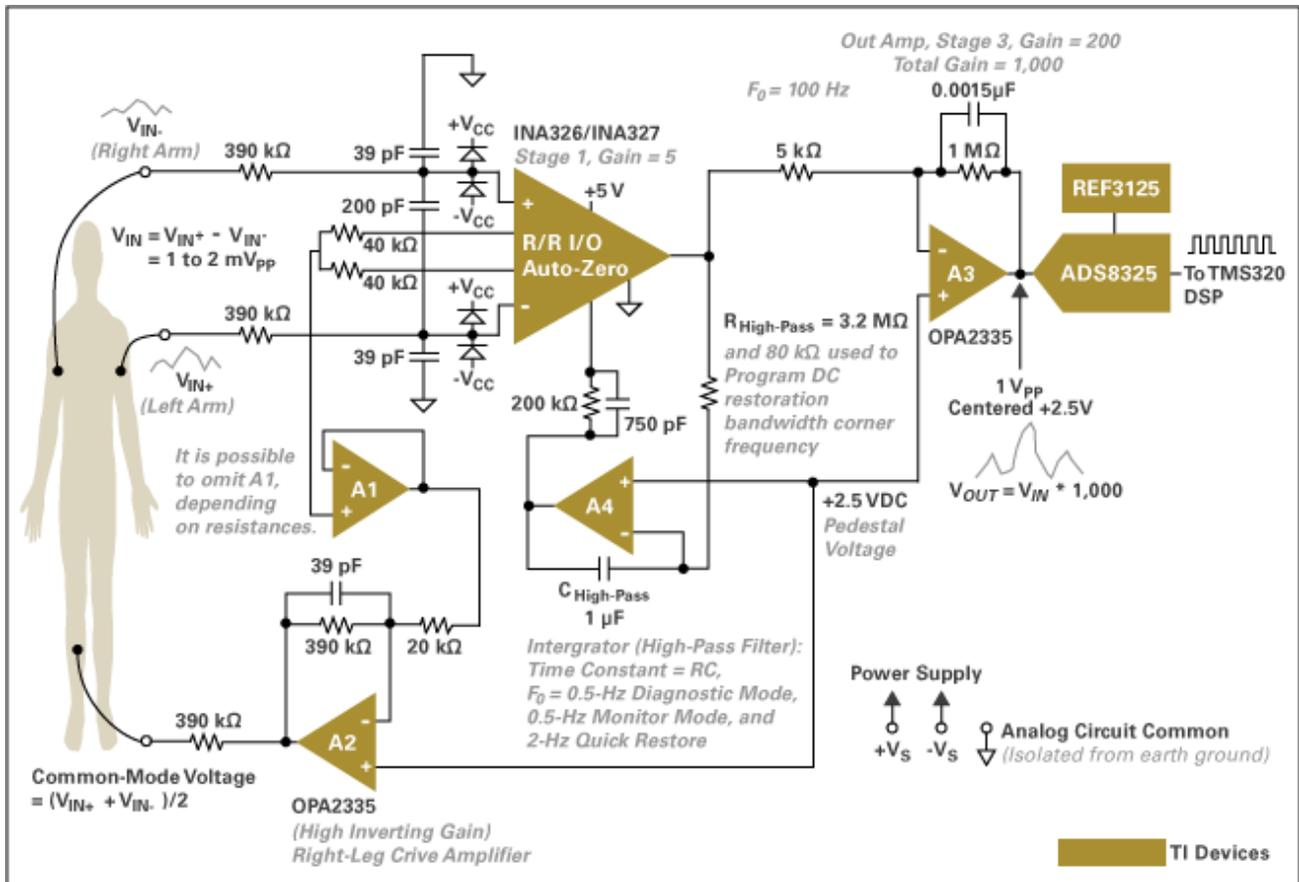

It is necessary to find a balance between these two example circuits.

### Make Your Own Clock

This activity is similar to the Make Your Own Phone Speaker activity implemented in January 2016 Bootcamp. Students would design circuitry to create an LED display. The display would change to show the time.

Topics examined:

- Electronics
- Electrical circuits
- Programming
- Electrical Engineering

<b>Design Principle</b>	<b>How it was implemented</b>
Real World Relation	<ul style="list-style-type: none"><li>• Introduces students to personal electronics</li></ul>
Take Home Aspect	<ul style="list-style-type: none"><li>• Students get to keep the clock which they constructed</li></ul>
Success	<ul style="list-style-type: none"><li>• Detailed step by step instructions with pictures could be provided for circuit design</li></ul>
Challenging	<ul style="list-style-type: none"><li>• The complex circuitry poses a challenge for students</li></ul>
Group Work	<ul style="list-style-type: none"><li>• Students can work together to assemble their circuits</li></ul>
Design and Build	<ul style="list-style-type: none"><li>• Students can design their LED display and then make it</li></ul>

<b>Pros</b>	<b>Cons</b>
<ul style="list-style-type: none"><li>• Incorporates all design principles</li><li>• Can adapt material from Make Your Own Phone Speaker activity</li></ul>	<ul style="list-style-type: none"><li>• High reliance on circuitry knowledge, may need other activities to supplement the electronics portion of this activity</li><li>• LEDs and other circuitry material is expensive</li></ul>

The following is an example circuit diagram of an LED clock

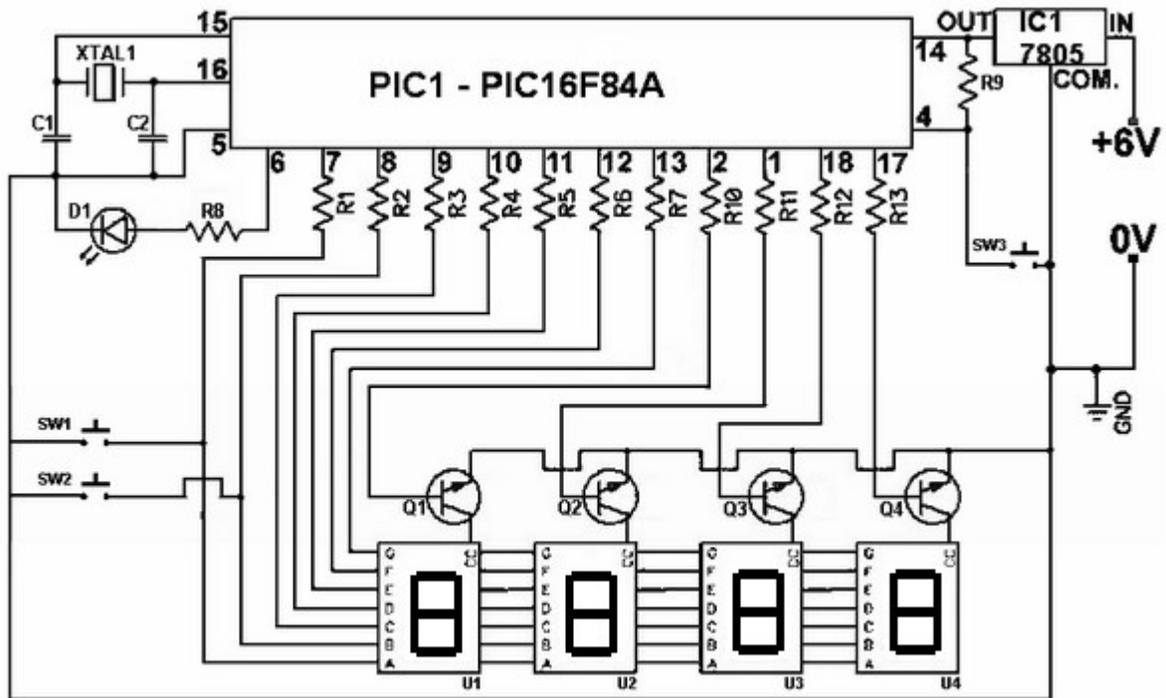

### 3D Printed Quadcopter

The 3D Printed Quadcopter received very high interest ratings. Students would design and build their own Quadcopter.

Topics examined:

- Electronics
- Electrical circuitry
- 3D modeling and printing
- Mechanical design
- Flight
- Aerospace engineering
- Programming
- Physics mechanics

<b>Design Principle</b>	<b>How it was implemented</b>
Real World Relation	<ul style="list-style-type: none"> <li>• Relates to research in drone technology</li> <li>• Relates to research in 3D printing technology</li> <li>• Relates to a modern form of transportation</li> <li>• Allows students to explore various disciplines in STEM</li> </ul>
Take Home Aspect	<ul style="list-style-type: none"> <li>• Students will leave the Bootcamp with something they built, a quadcopter</li> </ul>
Challenging	<ul style="list-style-type: none"> <li>• Students will be challenged with designing portions of the body for their quadcopter</li> </ul>
Group Work	<ul style="list-style-type: none"> <li>• Students can assist each other with designing the body of the quadcopter and assembling the other parts of the quadcopter</li> </ul>
Design and Build	<ul style="list-style-type: none"> <li>• Students will design a portion of the body of their quadcopter</li> </ul>

<b>Pros</b>	<b>Cons</b>
<ul style="list-style-type: none"> <li>• Incorporates all design principles</li> <li>• Appeals to a wide range of student interests</li> <li>• Explores various topics in STEM</li> <li>• Explores topics in STEM not typically associated with each other</li> <li>• Shows students what they can accomplish on their own</li> </ul>	<ul style="list-style-type: none"> <li>• Prohibitively expensive</li> <li>• Circuitry and other topics are quite complex</li> <li>• Success is not guaranteed due to the difficulty and complexity of building a quadcopter</li> </ul>

The following is an example of a quadcopter with a 3D printed body:





The following is circuit diagram of the electronic components needed to assemble a quadcopter.

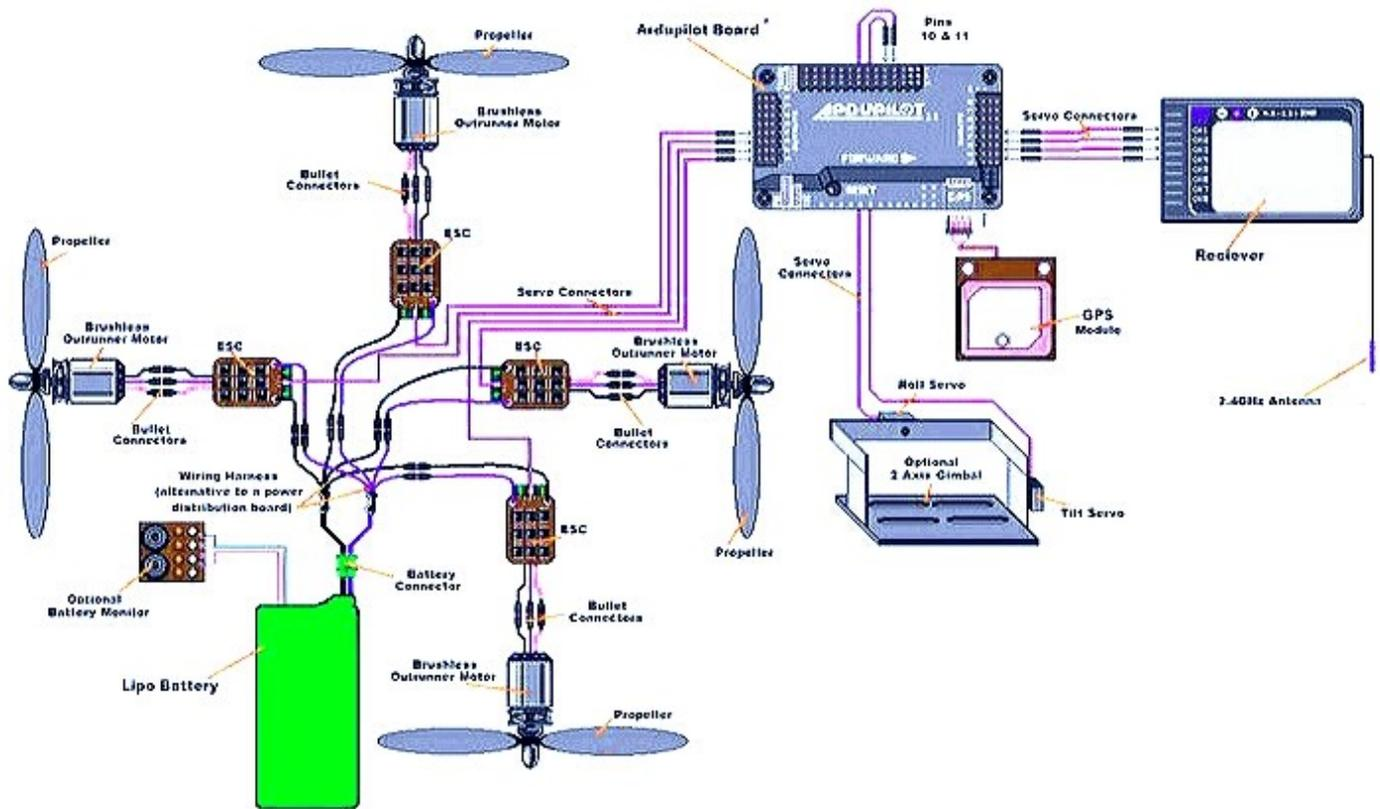

This activity is quite complex, and if it is not simplified, it may not be suitable for a Bootcamp activity. It could, however, be used in a different program CSIRO runs.

## 4. Post-Bootcamp Survey

This is an example survey that serves to gain a perspective on student interests. Once student interest is determined, this information can be used to develop activities that students are interested in attending.



# Post-Bootcamp Survey

**Gender**

Female

Male

**Age**

**What subjects were you most interested in before coming to Bootcamp?**

English

History

Math

Biology

Chemistry

Physics

Other:

**Why did you choose to attend Bootcamp? (Select all that apply)**

Interested in the activity

To go on the lab tours

To meet researchers and scientists

To understand science careers

My parents made me

I had nothing else to do during the holiday

Other:

Please rate how much you enjoyed Day 1 of the Bootcamp activity on a scale of 1 to 5. (1=did not enjoy, 5=enjoyed)

1 2 3 4 5



Please rate how much you enjoyed Day 2 of the Bootcamp activity on a scale of 1 to 5. (1=did not enjoy, 5=enjoyed)

1 2 3 4 5



What was your favorite part of the Bootcamp activities?

What made this part most enjoyable for you?

What was your least favorite part of the Bootcamp activities?

What made this part least enjoyable for you?

If you could run this Bootcamp activity yourself, what would you change and why?

**What were the most important things you learnt about during the Bootcamp activities?**

Pick 1 or 2

- Circuitry
- Sound and Waves
- 3D printing
- Teamwork

**What was the most surprising thing about the Bootcamp activities?**

**How likely are you to attend another Bootcamp?**

- I will attend another Bootcamp
- Very Likely
- Likely
- Possibly
- Not Likely
- I will not attend another Bootcamp

**What topic(s) would you like to see featured at Bootcamp?**

- Computer Programming
- Multimedia Design
- Biology
- Chemistry
- Geology
- Physics
- Aerospace
- Electrical and Circuitry
- Robotics
- Green Energy
- 3D Printing
- Astronomy
- Entomology
- Other:

**How likely are you to recommend Bootcamp to a friend?**

- I will recommend Bootcamp to a friend
- Very Likely
- Likely
- Possibly
- Not Likely
- I will not recommend Bootcamp to a friend

## 5. Development Stage Considerations

### Safety is the Number #1 Priority

**Description:** Account for all possible safety hazards and think of whether they can be overcome.

**Reasoning:** It is crucial that students are exposed to no dangers. CSIRO cannot let any accidents happen.

**Implementation:** Tasks that involve major safety concerns should be completed by the instructors. If possible, most tasks should be completed by students after eliminating all safety risks. Any part of the activity that has potential safety hazards for the students, which cannot be completely addressed, should not be included at Bootcamp.

### Begin by Establishing an Emotional Connection

**Description:** Students should develop an emotional connection with the activities offered.

**Reasoning:** Science teaching is not an emotional-free world. Communication starts with a smile not a statistic.

**Implementation:** Demonstrate a cool way to use the final product of the activity. Show students physical objects, pictures or any new equipment they are going to use.

### Student Background Knowledge

**Description:** Assume students possess minimal background knowledge on the activity's subject.

**Reasoning:** Due to the age variations and the potential different education levels, some students might be less knowledgeable on a given subject than others. To account for extremes, when developing an activity one should assume there will be students that know nothing about the subject of the activity.

**Implementation:** When developing an activity, consider providing extra instructions or tip sheets that can be handed out to students who are struggling. Tasks can be tailored towards students with average knowledge, but must ensure students with no relevant knowledge still have the resources to succeed.

### Background Theory before Hands-on Activity

**Description:** Students should be provided background theory before engaging in a major hands-on activity.

**Reasoning:** It is important to understand why you are doing a lab-based activity beforehand. When presented with such an activity, students can feel overwhelmed if they don't have the relevant context.

**Implementation:** Give enough information to students so that they know what they are working towards. There doesn't need to be a detailed lecture, but to the very least a brief introduction on the subject.

### Incorporating New Material

**Description:** Activities should present students with new material

**Reasoning:** Students enjoy learning new material, which is outside of their school curriculum. Students are more engaged into activities that offer access to new equipment or new exciting concepts.

**Implementation:** Include modern technology or current research that is closely linked to the activity's topic.

### Avoid Overwhelming the Students

**Description:** Make sure students don't get overwhelmed by the quantity or difficulty of the assigned tasks.

**Reasoning:** Many students tend to give up when they believe the work is too much or too difficult to be completed.

**Implementation:** Have different options for assigned tasks, each with different difficulty. Students should be given an objective that isn't too difficult or too time-consuming and the option to continue working on additional tasks or not depending on their preference.

### Lecturing Kept at a Minimum

**Description:** The amount of lecturing during an activity should be minimized as much as possible.

**Reasoning:** Students come to Bootcamp to see the fun side of STEM. The primary function of Bootcamp is not an educational one and students should not feel like they are participating in a classroom.

**Implementation:** Whenever possible, teach students necessary theory through interactive activities or demonstrations. Only resort to traditional classroom lecturing if absolutely necessary.

### Do Not Limit Students' Freedom

**Description:** Give students open-ended tasks and give them enough resources to start but also the freedom to take it to any direction they feel appropriate.

**Reasoning:** Students develop a better understanding of concepts when they have ownership of how they learn. Students are more likely to be engaged when they are provided with resources and come up with answers themselves.

**Implementation:** Limit the material given to students and make suggestions about what they should be thinking. In a way, mentor the students while they are learning themselves. Make sure the students feel challenged and not bored by giving them a lot of information.

### Students Should Ask Questions

**Description:** Encourage students to want to ask questions.

**Reasoning:** A lot of times students think ideas just happen, teach them that there are steps that need to be taken. Place importance in the communication between students. They need to be thinking about "how to ask the right question to get them to solve the problem".

**Implementation:** Give an example of the scientific method in use. Be sure to ask and answer questions yourself when explaining concepts and running the activity to help students develop a similar process for themselves.

### Pilot Testing Activities

**Description:** To finalize development, all activities should be thoroughly pilot tested.

**Reasoning:** Prior to pilot testing, the timing, difficulty levels, and schedule of an activity are all simply educated guesses.

**Implementation:** Run the complete activity, including presenting background knowledge and all instructions for an activity to confirm timing and difficulty of all tasks. Make sure the participants of the pilot tests reflect, to the best extent, all possible variations of the targeted audience in terms of prior knowledge, interest, and skills.



# Appendix N: Magnet Activity Instructions

## Activity: Magnetic Putty

### Materials:

- Safety Glasses
- Disposable Gloves (1 or 2 pairs per student)
- 2 Disposable Clear Plastic Cups (Per Student)
- 2 Popsicle Sticks (Per Student)
- 3 Plastic Spoons (Per Student)
- 1 Disposable Plastic Bowl (Per Student)
- 1 Plastic Ziploc bag (Per Student)
- PVA Glue (Students will need 6 spoonful's with their plastic spoon)
- Borax Powder (Students will need 1 ½ spoonful's with their plastic spoon)
- Iron Oxide Powder (Each student will use between 1-2 spoonful's)
- Water (Tap water works fine)
- Paper Towels (NOT napkins or tissues, the paper is too weak)

### Procedure:

Put on Safety Glasses and Gloves now

Saturated Borax Solution:

- Fill one of the plastic cups 3/4ths of the way up with tap water
- With a plastic spoon, add 1 ½ spoonful's of Borax to the cup of water and stir with Popsicle stick. (Do not throw away spoon yet)
- Mix as well as you can, there should be powder left on the bottom of the cup to let you know the solution is saturated with Borax.

Putty Chemistry:

- In a new plastic cup with a new plastic spoon, add 6 spoonful's of PVA glue. (Throw away this Plastic Spoon)
- Put a Popsicle stick into this plastic cup with glue and begin to mix.
- Have a partner grab the plastic spoon that scooped the Borax powder.
- Using that spoon, add in 1 spoonful of the Saturated Borax Solution to the glue cup, while mixing with Popsicle stick. (Do not stop mixing, the glue will begin to clump on the popsicle stick)
- Add another spoonful of Saturated Borax Solution to the glue cup while continuing to mix. (If all of the glue has attached to the popsicle stick then you can move on to the next step, if not, add half a spoonful of Saturated Borax Solution at a time until all of the glue is stuck to the popsicle stick.

Putty Drying:

- Take Popsicle stick with Putty on it and remove the Putty into the Plastic bowl.

- Dab Putty with paper towels to try and remove some moisture, it will be very wet and sticky. Try to keep it from sticking to the paper towel.
- Play with Putty by squeezing it and kneading it in your hands.
  - The Putty will be very sticky at this point and if it sticks to your hands, just keep playing with it and it will eventually come off and stick back to the Putty ball.
- After about 5 - 10 minutes of playing with the Putty, put it in the Ziploc bag and seal after removing excess air. Place in sun to dry

TinkerCad: Students will design the lid for their 3D printed Magnetic Putty case

- Open up TinkerCad and run through a few short tutorials
- Once comfortable enough with the software, add a design and your name to the lid. Ex: embossing a star with your name inside

Put on Safety Glasses and Gloves

Magnetizing:

- After sitting in the Ziploc bag for 30 minutes, the Putty should have a much better consistency.
- Wipe off any moisture in the plastic bowl with a paper towel.
- Take Putty out of bag and place in bowl.
- Flatten out the putty to fit the bottom of the plastic bowl.
- Add 1/4th of a spoonful of Iron Oxide powder to the center of the putty.
- Fold the Putty around the Iron Oxide and begin to mix the powder into the Putty.
- Continue folding and kneading the putty in your hands until the putty feels smooth and the powder is completely mixed in.
  - Repeat the previous 3 steps until 1-2 spoonful's of powder has been mixed into your putty. The more you add the more magnetic your Putty will become.

Neodymium Magnets:

- Using different neodymium magnets, check how lively you can make your putty.
- Play with the putty itself, try to make pieces follow the magnet.
- Get the putty to eat your magnet.

Storing:

- Keeping your Putty in a Ziploc back will keep it from drying out and last as long as possible.
- When you get your case, put the Putty in the case, and the case in the Ziploc bag.

## Activity: Ferrofluid Procedure (For the Educator)

### Materials:

- Disposable gloves (1 pair per student)
- Safety Glasses
- Large rectangle dish to work in incase of spills. (1 per group)
- Disposable apron
- Petri dishes (4)
- Plastic cup (2)
- Food coloring to color water
- Mineral Oil
- Vegetable oil (50 drops per group)
- Plastic transfer pipettes (3)
- zip lock bags 050x075x.040 mm (4 per group)
- Neodymium magnets (4)
- Paper towels (many)
- Oleic Acid ( $\frac{3}{4}$  teaspoon per student)
- Iron Oxide (2 teaspoons per student)
- Graduated Cylinder (1)
- Funnel (1)
- Measuring spoons x10 (Teaspoon and fractions of teaspoons)
- feather (4)
- Dawn dish soap
- cocoa powder

### Feather Demonstration:

- In a bowl, add vegetable oil and cocoa powder to simulate a crude oil spill
- Dip each feather into the oil to cover them to simulate a bird in the oil spill
- Try cleaning off one of the feathers in cold water by dipping it in and rubbing
- Repeat with warm water
- Repeat with warm water and dawn dish soap
  - The water and dish soap should work the best and hopefully fully clean the feather
- Now cover the 4th feather in iron oxide powder and remove it with a neodymium magnet in a Ziploc bag. Should be able to clean nearly 90% of the oil off the feather or more.
  - Iron oxide and magnets is only 90% as effective, however it is about  $\frac{1}{3}$  the cost

### Electromagnet Demonstration:

- Use the ferrofluid and electromagnet to show the students a cool structure you can make with ferrofluid

- Use regular magnets and neodymium magnets to show the effects of ferrofluid to the students

**Have students write their own hypothesis (use an If ... Then ... statement):** Ex. If we add iron oxide powder to oil in water, then we can use a magnet to pull out the oil with the iron oxide.

**Have students write a Reasoning for their hypothesis:** Ex. The iron oxide powder will mix with the vegetable oil to create a ferrofluid that can be removed from the water by using a strong magnet.

After having written a hypothesis, break the students into groups of 3.

### **Directions:**

In this science activity, students will work in groups of 3 to design and test a method to clean up oil spills in water using ferrofluids and a strong magnet.

Caution: Iron Oxide powder and its mixtures (Ferrofluids) are messy. They can stain skin, clothing, and surfaces. At all times, be careful not to stain yourself or anything around you.

Safety: Neodymium magnets are very strong. Keep away from magnetized material, phones, computers, and other electronic devices. Do not let the neodymium magnets slam together.

**A well designed experiment should look something like the following:**

### **Preparing Petri dishes**

1. Put on your safety glasses, disposable gloves, and apron.
2. Fill each petri dish halfway with water.
3. Dry your hands and add a few drops of food coloring to each petri dish.
4. Using a plastic transfer pipette, add 10 drops of vegetable oil to each petri dish.

### **Preparing Iron Oxide Powder, Iron Oxide Powder Mixed with Oleic Acid, and Ferrofluid**

1. Take 1/8 teaspoon of iron oxide powder and place it on top of the vegetable oil in the second petri dish. Repeat 3 more times, trying to cover all of the vegetable oil with iron oxide powder.
2. In a plastic cup, add 1/2 teaspoon of oleic acid and 1/2 teaspoon of iron oxide powder. Mix thoroughly.

3. Using a plastic transfer pipette, transfer the iron oxide powder and oleic acid mixture on top of the vegetable oil in the third petri dish.
4. In a new plastic cup, add  $\frac{1}{4}$  teaspoon of oleic acid,  $\frac{1}{2}$  teaspoon of iron oxide powder, and  $\frac{1}{2}$  teaspoon of mineral oil. (This is a Ferrofluid) Mix thoroughly.
5. Using a plastic transfer pipette, transfer the ferrofluid on top of the vegetable oil in the fourth petri dish.

### **Preparing the Magnets**

1. Place one neodymium magnet in a Ziploc bag and close it air tight.
2. Repeat step one 3 more times for each of the 4 neodymium magnets.

### **Removing the Oil**

1. Dip the magnet into the first petri dish and run it through the oil mixture slowly and smoothly.
2. Wipe off the plastic bag on a paper towel.
3. Repeat steps 2 and 3 another 4 times for a total of 5.
4. Do this process for the rest of the petri dishes using new sandwich bags each time.

### **Measuring Oil Left**

1. Using a funnel, pour the oil and water left into a graduated cylinder.
2. Let the oil and water separate and measure the amount of oil remaining.
3. Rinse off glassware and repeat for the next 3 petri dishes to see which methods most effectively cleaned the water.

### **Activity: Ferrofluid Procedure (For the Student)**

In this science activity, you will test this theory in groups of 3 by using Ferrofluid, Iron Oxide powder, and Iron Oxide mixed with Oleic acid to try and clean out oil from water. Each group will design their own experiment to determine which method will help succeed the most in cleaning up as much of the oil spill as possible?

**Hypothesis (use an If ... Then ... statement):**

**Reasoning for your hypothesis:**

#### **Materials:**

- Disposable gloves (1 pair per student)
- Safety Glasses
- Large rectangle dish to work in incase of spills. (1 per group)
- Disposable apron
- Petri dishes (4)
- Plastic cup (2)
- Food coloring to color water
- Mineral Oil
- Vegetable oil (50 drops per group)
- Plastic transfer pipettes (3)
- zip lock bags 050x075x.040 mm (4 per group)
- Neodymium magnets (4)
- Paper towels (many)
- Oleic Acid ( $\frac{3}{4}$  teaspoon per student)
- Iron Oxide (2 teaspoons per student)
- Graduated Cylinder (1)
- Funnel (1)

#### **How to Make your Ferrofluid:**

1. In a plastic cup, add  $\frac{1}{4}$  teaspoon of oleic acid,  $\frac{1}{2}$  teaspoon of iron oxide powder, and  $\frac{1}{2}$  teaspoon of mineral oil. Mix thoroughly

#### **How to Make your Iron Oxide and Oleic Acid Mixture:**

1. In a plastic cup, add  $\frac{1}{2}$  teaspoon of oleic acid and  $\frac{1}{2}$  teaspoon of iron oxide powder. Mix thoroughly.

**When just using Iron oxide powder, use ½ teaspoon and add it slowly.**

**Designing your experiments:**

1. Using as much of the materials provided as you need and work in your group to design an experiment that will test which mixtures can best removed vegetable oil maybe (motor oil) from water using a strong magnet.
2. Write this out step by step!

**Hints:**

1. Remember to have a control.
2. Do not bias any one sample of another.

**Bootcamp Coordinator approval:**

1. After writing up your procedure, bring it to a Bootcamp coordinator who will check it out and make sure everything looks good for completing the activity.
2. Once a coordinator approves your groups experiment, you may begin.

**Conclusion:**

Do separately

1. Was your hypothesis correct?

# Appendix O: Magnet Activity PowerPoint Instructions

## Overview

Briefly go over the plan for the day. Explain that students will be making magnetic putty then show them the video as a demonstration of the activity.

## Polymer and Cross-Linking

Explain that the putty that students will be making is a polymer. Then ask the students if they can think of any other examples of polymers.

Connect polymers to CSIRO by discussing how the banknotes that CSIRO developed contain polymers.

Now they know examples of polymers, go over what makes up a polymer. Start at the atomic level. Begin with elements then to atoms. Say that each atom is only one element. Briefly go over nucleus, neutrons, protons, and electrons. Then, move onto molecules and explain that molecules are made of many atoms.

Move onto monomers and polymers by asking what the subunit of a polymer is. The answer is a monomer and explain that each monomer is a specific molecule.

Go into the different types of polymerization and how many monomers polymerize to create a polymers.

Discuss crosslinking specifically in PVA glue which is what they will be using to create the putty.

Activity: Ask for the students to get into groups of about 5 students. Can be more than 5. Students should form a circle facing the center and hold hands with people across from them. Each person should be holding hands with 2 different people, and not the ones next to them. The goal of this activity is to them move around and try to untangle the circle. This activity shows how strong the crosslinking bonds are because the students will have a difficult time untangling themselves.

## Making Putty

Go over safety concerns. These include all PPE and warnings against consuming any of the materials. All concerns can be found on the activity template.

Please see “Silly Putty Instructions” for the complete step by step procedure.

## TinkerCAD

Discuss how that polymers are commonly the material used in 3D printing. Connect this idea to CSIRO by showing the picture of the biodegradable polymer in a 3D design.



Go on to say that CSIRO developed a 3D printer that prints titanium and discuss the advancements that have been made.

Brief overview of how to use TinkerCAD. Then have students use their laptops to do some of the TinkerCAD tutorials until students feel like they understand it enough to add their name and a design to their case cover. Let the students design their cover and be sure to have an instructor approve of the design before the student submits.

### **Oil Spills and Wildlife**

Go over the history of oil spills based on information in the background packet. Talk about how the amount of oil spills per year has been decreasing but they still have a huge impact on wildlife. Then go into a discussion about how wildlife is affected by oil spills.

Talk about how there has been research on using magnets to clean up oil spills. Here is a video to learn more about the research: <http://video.mit.edu/watch/cleaning-up-oil-spills-with-magnets-12612/>

### **Demonstration**

Setup 4 bowls of water. They should contain the following:

1. Cold Water
2. Hot Water
3. Water and Dawn soap
4. Iron Oxide powder (just enough to cover one feather)

Mix together vegetable oil and cocoa powder to create the 'crude oil.'

Dip a feather into the crude oil. Try to clean it in the cold water. Continue to dip feathers into the oil and try to clean it using each bowl.

For the bowl with iron oxide powder, cover the oiled feather with the powder and remove the oil with a magnet.

Show the statistics involving cleaning up oil spills with Dawn compared to magnets. Highlight how much cheaper it is.

### **Outline**

Discuss plan for the day.

### **Magnets**

See if anyone can name the different types of magnets then review them.

Then go over the properties of magnets. Use the background packet for reference. Highlight that ferrofluid will move in the direction of the magnetic field.

### **Ferrofluid**

Describe how ferrofluid acts as both a liquid and solid.

Discuss the need for surfactant and explain how oleic acid surrounds each iron oxide particle. It does this because the polar head is attracted to the iron oxide and the nonpolar tail is attracted to the oil the ferrofluid is in. Be sure to explain that polar means it is attracted to water and nonpolar is not attracted to water.

### **Ferrofluid Experiment**

Go over what the students will be making a hypothesis about and how to form a formal hypothesis.

Follow the instructions in the “Ferrofluid Experiment Instructions” to conduct the experiment

### **Magnetic Putty**

Again refer to the “Silly Putty Instructions” in order to complete this activity with the students.

Provide the students with magnets to play with their putty.

Hold a competition: Using only their magnet provided, see which students can stretch out their putty the most. Have the students measure how far they stretched their putty and the student who stretched it the longest wins.

# Appendix P: Magnet Activity Background Information

## 1. History of Magnets

The history of magnets dates back to a legend from 4,000 years ago. A shepherd named Magnes was herding his sheep and the nails in his shoes stuck to a large, black rock. He began to dig into the Earth to figure out what was causing the phenomenon. He found lodestones which contain  $\text{Fe}_3\text{O}_4$ , a naturally magnetic material. Lodestones, with lode meaning lead or attract, were then commonly referred to as magnetite. These stones were then further hypothesized about by the Greek and Chinese. In the first century B.C., magnetite was mainly seen as an object that held magical powers and was used to ward off evil spirits. People began to realize that iron was what was attracted to magnetite, but they found that magnetite when floating in water, pointed to the north. This was the first version of a compass and the Chinese later developed the mariner's compass using this concept.

In 1269, the first true discovery was made. Gilbert Peter Peregrinis who documented everything known about magnets at the time while safely inside the wall of Lucera, a town in Italy, which was under siege at the time. In the 1600s, William Gilbert realized that the earth was a giant magnet. In addition he made the discovery that magnets could be made by beating wrought iron and that magnetism is lost through heating.

Magnets were then related to electricity in 1820 by Hans Christian Oersted and then in 1862 by James Clerk Maxwell. They showed that when current flowed through a magnet, there was a magnetic field in the surrounding space. This discovery was so remarkable as the discovery of the fundamental part of the phenomenon, the electron, had not yet been discovered.

<http://www.howmagnetwork.com/history.html>

## 2. How Magnets Work

A magnet is an object that attracts iron, steel, nickel, and cobalt. Every magnet has a north and a south pole. Like poles repel and unlike poles attract. They are also able to create a magnetic field. Magnetic fields can be produced around a wire when an electrical charge flows through it. A magnetic field is drawn using lines of force. Lines are drawn away from the north pole and towards the south pole. Compasses are a good way to visualize the field. The needle of a compass will always point in the direction that is tangential to the force, thus it will point toward the north. An important property of the magnetic lines of force are that the lines are closest together at the poles and widely separated further away from the poles, and also the lines never cross.

<http://www.howmagnetwork.com/>

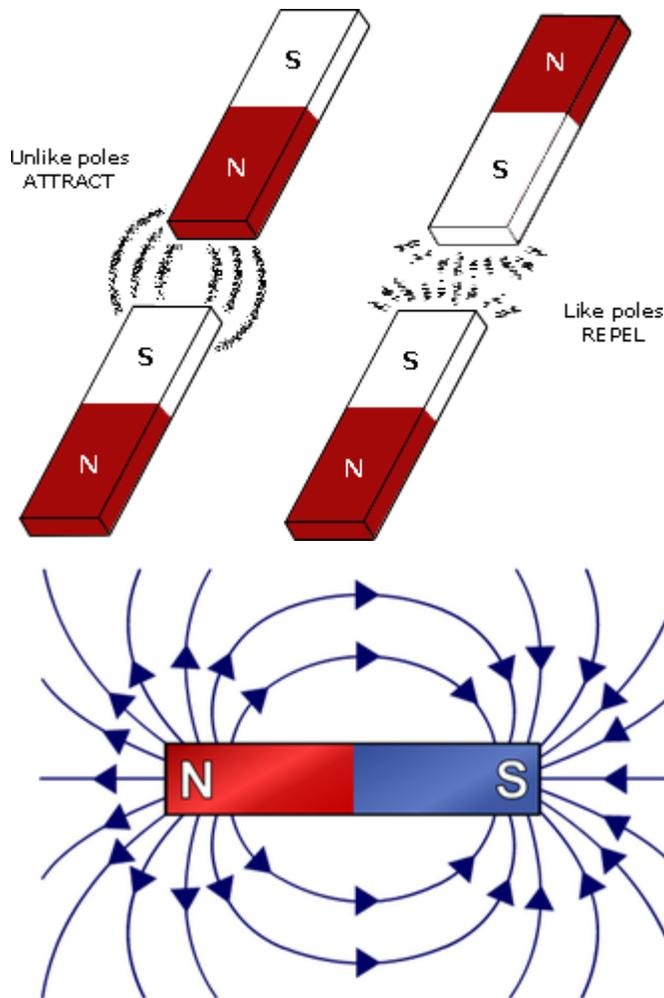

<http://www.physbot.co.uk/magnetic-fields-and-induction.html>

### 3. Types of Magnets

There are four different types of magnets: ceramic, alnico, neodymium, and samarium cobalt. Ceramic magnets are commonly seen in refrigerator magnets and are not very strong. They are mostly made up of iron oxide in a ceramic composite. Alnico magnets are stronger than ceramic magnets as they are made from aluminum, nickel and cobalt. Neodymium and samarium cobalt magnets are both forms of rare earth metal magnets. Neodymium magnets are made of iron boron and neodymium, a rare-earth element. Samarium cobalt magnets are simply cobalt and samarium, another rare-earth metal. Both of these rare-earth magnets are stronger than the other two types.

<http://science.howstuffworks.com/magnet.htm>

#### 1.4 Industrial uses

Magnets have been used in a variety of industries. Magnets used in medicine and health date back to 2000BC. Lodestones were used by the Chinese at acupuncture sites. Magnetic therapy is still used today. Many athletes use tectonic magnets for pain relief. There are also magnetic mattress pads and beds that help relax the body. In addition, these alternative medicine reasons to use magnets, magnets are an essential part of X-rays and Magnetic Resonance Imaging (MRI). X-rays allow for quick diagnosis of broken bones and other injuries. MRI's are even more advanced as they allow doctors to see how body tissues react to magnets fields which allow for scans of our brain and heart.

Magnets are also commonly used in electronics. Cathode ray tubes inside of televisions stream electrons at the screen and a powerful electromagnet deflects the electrons across the screen. Computer screens use a similar technology. Computers also store information using an iron coated material that stores magnetic fields.

Magnets are used in many different fields as a way to sort or separate items. In mining, they can be used to separate metals from iron ore, and in food manufacturing, they can be used to rid food of small iron particles. Magnetics are also found in headphones, some conveyor belts, credit cards, telephone receivers, and much more.

<http://www.howmagnetwork.com/uses.html>

#### 4. Ferrofluid

Ferrofluids have the fluid properties of a liquid and the magnetic properties of a solid. They contain tiny particles (~10nm diameter) of a magnetic solid suspended in a liquid medium. They were originally discovered in the 1960s at the NASA Research Centre, where scientists were investigating different possible methods of controlling liquids in space. The most common type of ferrofluid contains nanoparticles of magnetite, Fe<sub>3</sub>O<sub>4</sub>. The ferrofluid is prepared by combining an Fe(II) salt and an Fe(III) salt in basic solution. The resultant mixed valence oxide, Fe<sub>3</sub>O<sub>4</sub>, precipitates from solution:

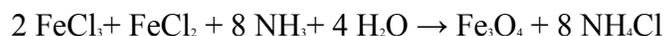

The particles of magnetite must remain small in order to stay suspended in the liquid medium. Magnetic and van der Waals (dispersion) interactions must be overcome to prevent the particles agglomerating. One way of keeping the particles well separated is by adding a surfactant to the liquid medium. The surfactants can generate either steric or electrostatic repulsions between the magnetic particles.

For example, cis-oleic acid can be used as a surfactant that produces steric repulsion. The surfactant is a long-chain hydrocarbon with a polar head that is attracted to the surface of the magnetite particle, forming a surfactant coating on the particle's surface. The long non-polar chains of the tails act as a repellent cushion and prevent the close approach of other magnetite particles. Water is removed from the mixture, leaving the oil as the liquid medium.

Alternatively, ionic surfactants such as tetramethylammonium hydroxide can be used as a surfactant that produces electrostatic repulsion in an aqueous medium. The hydroxide ions are attracted to the surface of each magnetite particle, forming a negatively charged layer at the magnetite surface. The tetramethylammonium cations are attracted to the negatively charged

forming a positive layer. When magnetite particles approach each other, the repulsions between their positively charged layers keep them from getting too close.

### *Applications of Ferrofluid*

Ferrofluids are used in rotating shaft seals- they behave as a liquid O-ring where a rotating shaft enters either a low- or high- pressure chamber. The ferrofluid is held in place by permanent magnets and form a tight seal, eliminating most of the friction produced in a traditional mechanical seal. These ferrofluid seals are found in vacuum chambers used in the semiconductor industry and rotating anode X-ray generators. Ferrofluid seals are used in high-speed computer disk drives to eliminate harmful dust particles or other impurities that can cause the data-reading heads to crash into the disks.

Ferrofluids are also used to improve the performance of some loudspeakers, by dampening unwanted resonances and providing a mechanism to heat from excess energy supplied to the electric coil.

In the biomedical field, ferrofluids are being investigated as contrast agents for magnetic resonance imaging (MRI) and in the hope that they could carry medications to specific locations in the body through the use of applied magnetic fields.

Another interesting use is the tunable car suspension. Electromagnets surrounding ferrofluid-filled shock absorbers can control the viscosity of the fluid, and therefore the 'hardness' of the ride. This system, known as MagnetRide can be found on some vehicle models from GM, Audi, BMW and Ferrari.

## **5. Basic Chemistry and Magnetic Putty**

In order to understand the workings of putty, it is important to start with some basic chemistry. First all things on this planet are made up of elements. The smallest unit of an element is an atom. Atoms are made up of protons, neutrons and electrons. Protons have a positive charge, neutrons have no charge, and electrons have a negative charge. Protons and neutrons make up the nucleus in the center of an atom and electrons surround the nucleus. A combination of one or more atoms is a molecule.

Polymers are made up of monomers. Monomers are molecules that repeat within a polymer. These monomers are joined together through polymerization. There are two types of polymerization: condensation and addition

To find out more about these types of polymerization please refer to this site:  
<http://study.com/academy/lesson/what-is-polymerization-definition-types-process-reactions.html>

Magnetic putty is a polymer. It is a mixture of PVA glue and borax. These two compounds are linked through crosslinking. This cross-linking is shown in the picture below.

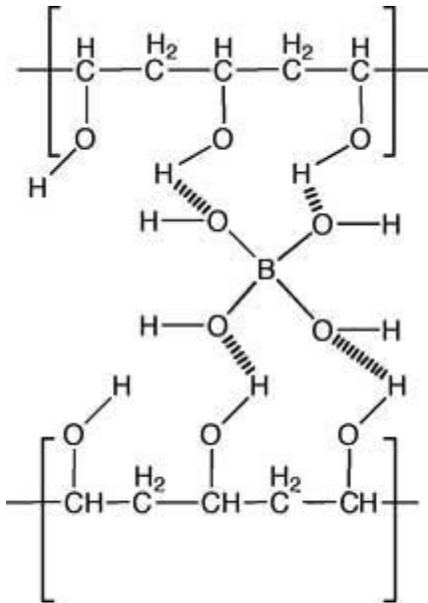

<http://www.nuffieldfoundation.org/sites/default/files/images/pva-cross-linking-128.jpg>

## 6. History of Oil Spills

Oil spills had been a huge problem in the past. As seen in the figure, the number of oil spills per year have decreased significantly, however, even the few that still occur cause huge problems.

Number of Spills Annually:

Year	7-700 Tonnes	>700 Tonnes
2010	5	4
2011	5	1
2012	7	0
2013	5	3
2014	4	1
<b>Total</b>	<b>26</b>	<b>9</b>
<b>Average</b>	<b>5.2</b>	<b>1.8</b>

[http://www.itopf.com/fileadmin/data/Documents/Company\\_Lit/Oil\\_Spill\\_Stats\\_2014FINALlowres.pdf](http://www.itopf.com/fileadmin/data/Documents/Company_Lit/Oil_Spill_Stats_2014FINALlowres.pdf)

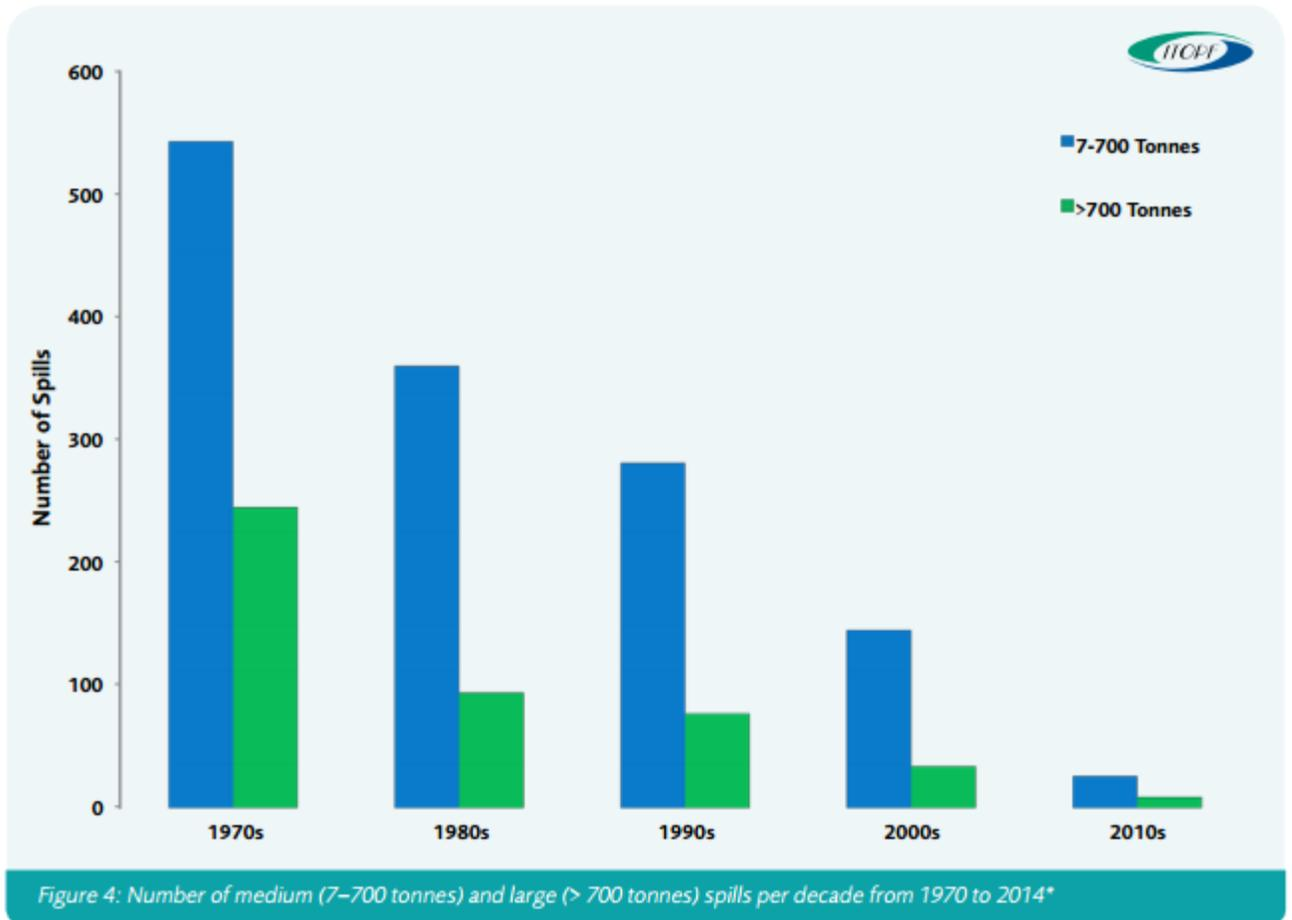

\* Only 5 years of data for the period 2010–2014

The largest oil spill in history was the BP oil spill of 2010. There were 206 million gallons of oil that was spilled into the Gulf of Mexico. One mile below the surface of the ocean, there was an explosion in BP’s Deepwater Horizon rig. This explosion alone killed 11 people. As the oil gushed out as rates as high as 2.5 million gallons per day, oil spread and wildlife was devastated in the gulf.

## 7. Current Technology for Cleaning Oil Spills

There are several ways of cleaning up oil spills. One method is the deployment of booms which surround and collect the oil in one location. Then a skimmer will come along and skim the oil off the top of the water because oils are less dense than seawater. The introduction of biological agents to hasten biodegradation of the oil is also a common method. Oils can be broken down by bacteria and other microorganisms into harmless substances such as fatty acids and carbon dioxide. This process of biodegradation can be sped up by introducing fertilizing nutrients, stimulating the growth of microorganisms needed. However, this technique is not always effective and experts need to make the decision to use this method on a case by case basis.



There are some controversial but potentially effective means of dispersing oil spills. Dispersants are used to break up the oil quickly, improving its rate of biodegradation. Dispersants reduce the surface tension in the oil, breaking it up and allowing it to be naturally broken down. However, this method is most effective in the first few hours of an oil spill and some dispersants can have negative environmental impacts, making the use of some dispersants controversial. Decisions on the use of dispersants need to be made on a case by case basis. Another controversial method of removing oil spills is in situ burning. This is done to prevent an oil spill from reaching a coast. Responders contain oil using fire-proof booms and then ignite the oil resting atop the water. This technique is controversial because it often involves large amounts of gas emissions and poses a safety risk to responders. For more information on current methods of oil spill cleanup, go to the following links.

<http://response.restoration.noaa.gov/oil-and-chemical-spills/oil-spills/spill-containment-methods.html>

<http://www.ceoe.udel.edu/oilspill/cleanup.html>

A new method for cleaning oil spills is being developed, largely as a response to the BP Deepwater Horizon spill in the Gulf of Mexico in 2010. The idea, created by researchers at the Massachusetts Institute of Technology, involves using magnetized nanoparticles to magnetize the oil and then pull the oil out of the water using powerful magnets. This method would not only be able to clean up the oil from the water but also allow for the recovery of the oil, which would've been lost otherwise. For more information on this new method, go to the following link.

<http://edition.cnn.com/2012/09/21/tech/oil-spill-magnets/>

## **8. Wildlife Animals Affected by Oil Spills**

Oil spills affect wildlife in two ways. First, by the actual oil and secondly, by the response of clean-up operations. Oil is dangerous to living things because its chemicals are harmful either by ingestion, irritation, or inhalation. Because oils float, the animals most affected by oil spills are animals like sea otters and birds that are mainly found on the ocean surface or shorelines.

For more information please refer to this site:

<http://response.restoration.noaa.gov/oil-and-chemical-spills/oil-spills/how-oil-harms-animals-and-plants-marine-environments.html>

# Appendix Q: Magnet Activity CSIRO Connections

## **Polymer Banknotes**

Source: <http://www.csiropedia.csiro.au/display/CSIROpedia/Polymer+banknotes>

<http://www.csiro.au/en/About/History-achievements/Top-10-inventions>

The first polymer banknotes developed in the world were developed by CSIRO following a request from the Reserve Bank of Australia in 1968. These polymer banknotes were developed as a scientific solution to combat forged notes. CSIRO's solution to creating these notes was to have a see-through panel and hologram embedded in the note and to use a polymer. The see-through panel and hologram is what makes these notes impossible to forge and the polymer used to make the note allows the notes to be more durable, more environmentally friendly, and less likely to carry dirt and disease. CSIRO views the polymer banknote as one of its top 10 inventions.

## **International Marine Incident Response Operations**

Source: <http://www.csiro.au/en/Research/OandA/Areas/Coastal-management/Marine-incident-response/International-response-operations>

CSIRO works with industry, governments, and academia to provide scientific knowledge and advice for offshore oil, gas, and shipping and covers the environmental, economic, and social factors associated with the entire oil and gas industry. CSIRO's expertise covers several areas including scientific and technical advice for oil spill countermeasures, ecological monitoring and ecotoxicology, damage assessment and environmental monitoring, national and international experience in oil spill response, and many other important fields needed to respond to maritime environmental incidents.

CSIRO assisted both BP and US maritime authorities during the BP oil spill in the Gulf of Mexico back in 2010. CSIRO assisted by using its prototype hydrocarbon sensor array to understand the location and movement of spilled oil in the Gulf. In January 2012, the cargo ship MV Tycoon broke up near Christmas Island, dumping tonnes of diesel oil, fuel oil, and phosphate dust into the sea. The Australian Maritime Safety Authority asked CSIRO to assist in developing environmental monitoring strategies.

## **RAFT (Reversible Addition-Fragmentation chain Transfer) Polymerisation**

Source: <http://www.csiro.au/en/Research/MF/Areas/Chemicals-and-fibres/Chemistry-and-biotechnology/RAFT>

<http://www.csiro.au/en/About/History-achievements/Top-10-inventions>

The challenge presented in creating RAFT technology was that traditional approaches to creating polymers tended to result in a diverse blend of polymers and gave manufacturers little control over molecular structure and properties. The RAFT process allows the manufacture of polymers with greatly improved performance allowing for application of polymers as novel drug delivery systems, personal care products, lubricants, and coatings.

RAFT is a form of controlled free radical polymerization, where a polymer is formed with the addition of free radical atoms or molecules, enabling the design of polymers with enhanced properties. RAFT can be used with a wide range of monomers and reaction conditions, giving manufacturers immense control over polymer size, composition, and architecture. This process can be used in all modes of free radical polymerization including solution, emulsion, and suspension polymerization methods. The RAFT process is considered one of CSIRO's top ten inventions.

## Lab 22

Source: <http://www.csiro.au/en/Research/MF/Areas/Metals/Lab22>

<http://www.csiro.au/en/Research/MF/Areas/Metals/Lab22/Horseshoe>

<http://www.csiro.au/en/News/News-releases/2015/Cancer-patient-receives-3D-printed-ribs-in-world-first-surgery>

<http://www.csiro.au/en/Research/MF/Areas/Metals/Lab22/Titanium-Heel>

Lab 22 is a multimillion dollar lab dedicated to additive manufacturing processes and to reducing the initial capital investment of businesses to utilize 3D printing in an effort to make it a more economically viable manufacturing method. Additive manufacturing reduces waste material, brings down labor costs, speeds up the development and test phase, allows for product customization, and the ability to make complex metal parts. These reasons are why CSIRO aims to reduce the initial capital cost to utilize this new technology, especially to smaller companies who cannot afford these technologies.

Lab 22 offers metallic 3D printing in metals such as titanium and aluminum, advanced machining for improved profitability, surface engineering for enhanced performance, laser assisted additive deposition, and laser heat treatments. The experts at Lab 22 work closely with businesses on cost-effective solutions by catering to a business's requirements, such as increased speed, performance, and affordability of technologies. They can capture 3D data and simulate the manufacturing process and in-service part performance. The designers at Lab 22 can also turn a new design idea into a testable prototype in a week.

The facilities at Lab 22 and the experts there have made many breakthroughs. One such breakthrough is the 3D printing of custom horseshoes for horses with laminitis, helping them recover from this painful disease. More recently in a world first surgery, Lab 22 3D printed a rib

cage for a cancer patient who had to have a tumor growing on his ribs removed which involved removing a large portion of his rib cage. In another instance, CSIRO designed and printed a heel bone for another cancer patient. It took two weeks from the hospital reaching out to CSIRO to the hospital performing the surgery, saving the man's leg. This example demonstrates how Australian manufacturers and healthcare providers can use 3D printing to quickly design, test, and produce customized biomedical products locally.

# Appendix R: Magnet Activity PowerPoint Slides

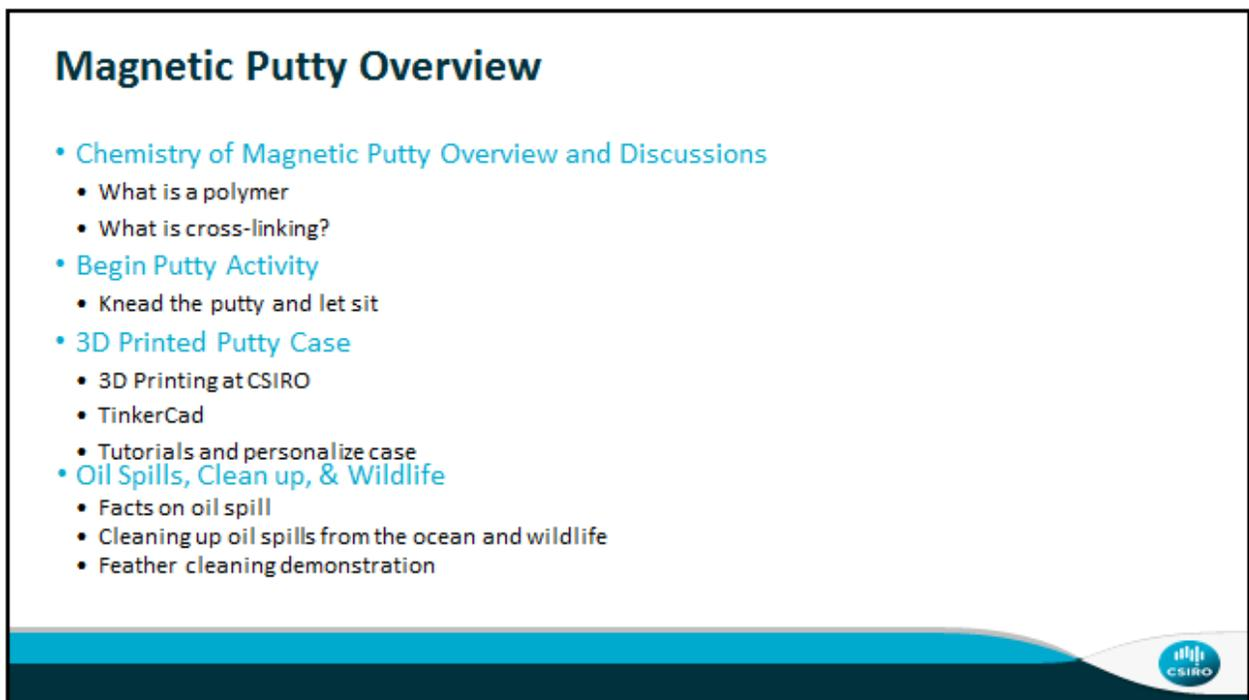
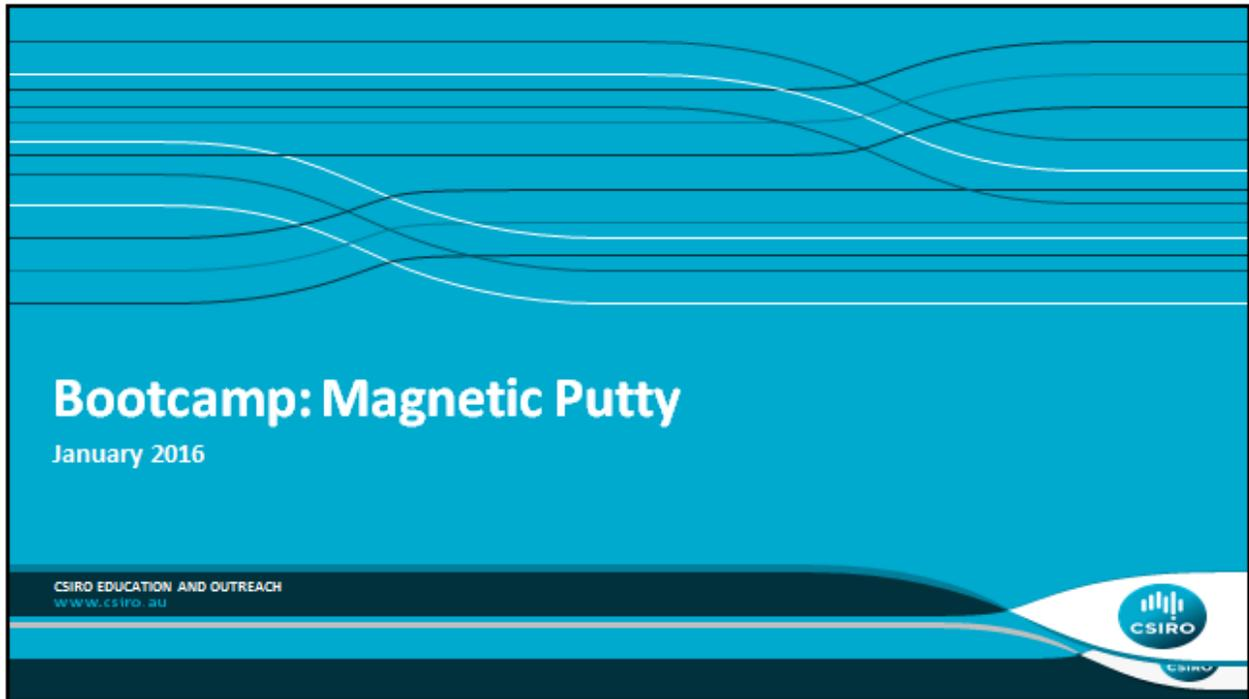

## Really Cool Magnet Video

- <https://www.youtube.com/watch?v=Vw0XCeYAeK8>



Source: <http://www.thisiswhymbroke.com/images/magnetic-smart-putty2-540x532.jpg>



## Polymers



## CSIRO: Polymer Banknotes

- CSIRO brought polymer banknotes to Australia in 1988.
- BOPP (Biaxially Oriented Polypropylene) is the polymer used.
  - It is non-fibrous and non-porous



### The benefits:

- Inability to be forged with an imbedded hologram
- More durable
- More environmentally friendly
- Carry less dirt and disease

Source: <http://cdn.csisr.com.au/wp-content/uploads/2015/04/ThinkstockPhotos-485435467-480x300.jpg>  
[http://www.csiropollie.csiro.au/Display/CSIROPollie/PolymorBanknotes\\_Http://image.mallin-china.com/487440021102111111/BOPP-Film-Fon-Teclajo-Laminacion-Adhesivo-Tapas.jpg](http://www.csiropollie.csiro.au/Display/CSIROPollie/PolymorBanknotes_Http://image.mallin-china.com/487440021102111111/BOPP-Film-Fon-Teclajo-Laminacion-Adhesivo-Tapas.jpg)



**Before we get to Polymers...what are the basic components that make them up?**



## Before we get to Polymers...what are the basic components that make them up?

Periodic Table of the Elements

Source: <http://teschbesideme.com/wp-content/uploads/2015/06/Periodic-Table-Color.png>



## Before we get to Polymers...what are the basic components that make them up?

Periodic Table of the Elements

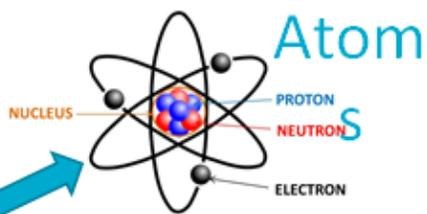

Source: <http://teschbesideme.com/wp-content/uploads/2015/06/Periodic-Table-Color.png>  
[https://upload.wikimedia.org/wikipedia/commons/e/e2/Stylised\\_Lithium\\_Atom.png](https://upload.wikimedia.org/wikipedia/commons/e/e2/Stylised_Lithium_Atom.png)





Before we get to Polymers...what are the basic components that make them up?

Periodic Table of the Elements

Elements

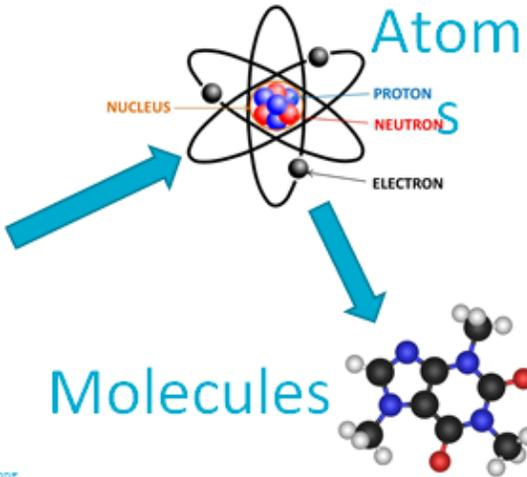

Sources: <http://teachbesideme.com/wp-content/uploads/2015/06/Periodic-Table-Color.png>  
[https://upload.wikimedia.org/wikipedia/commons/e/e2/Stylised\\_Lithium\\_Atom.png](https://upload.wikimedia.org/wikipedia/commons/e/e2/Stylised_Lithium_Atom.png), [https://upload.wikimedia.org/wikipedia/commons/4/41/Caffeine\\_Molecule.png](https://upload.wikimedia.org/wikipedia/commons/4/41/Caffeine_Molecule.png)



What are the specific unit molecules that make up a Polymer?



## What are the specific molecules that make up a Polymer?

- A polymer is simply a chain of monomers.
- Monomers- Each monomer is a molecule
  - Mono- means one
  - Poly- means many
  - Mer- means part
- Polymerization is the process by which polymers form.
  - There are two types of polymerization: condensation and addition
  - Here is one really cool polymer reaction:  
[https://www.youtube.com/watch?v=p-g\\_0wyhV9E](https://www.youtube.com/watch?v=p-g_0wyhV9E)

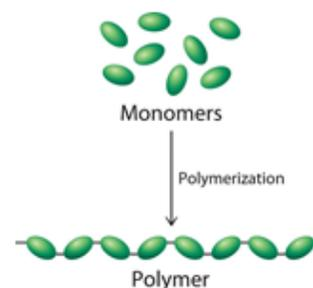

Source: [http://2012books.lardbucket.org/books/principles-of-general-chemistry-v1.0/section\\_16/5067492e0f61537f44bb6e57d5d26b2.jpg](http://2012books.lardbucket.org/books/principles-of-general-chemistry-v1.0/section_16/5067492e0f61537f44bb6e57d5d26b2.jpg)



## Cross-Linking in PVA Glue

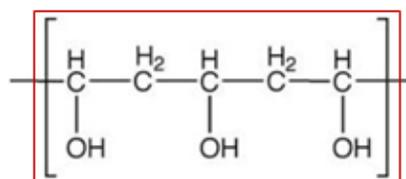

PVA Monomer

Borax molecule forming the crosslinking

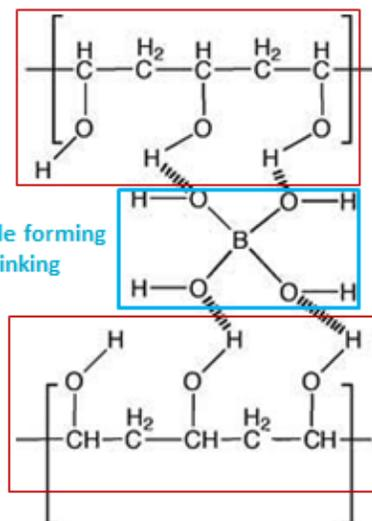

Source: <http://www.nc.org/chem-chemistry/Content/Files/CSIRO/Files/Images/Borax%20.JPG>  
<http://www.nuffieldfoundation.org/sites/default/files/images/pva-cross-linking%20.JPG>



## Activity

- Simulate this reaction!

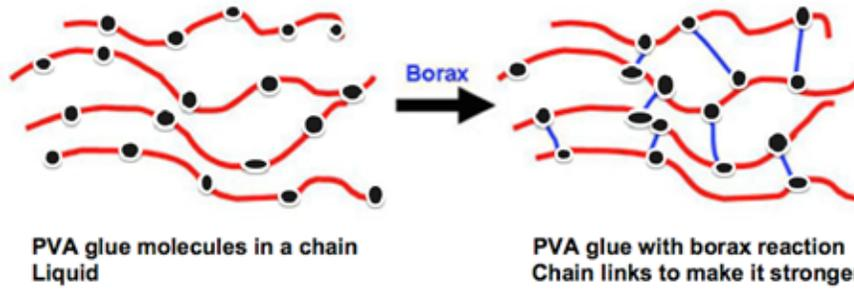

Source: [http://totars2014.weebly.com/uploads/4/5/5/1/4551064/6252064\\_orig.png](http://totars2014.weebly.com/uploads/4/5/5/1/4551064/6252064_orig.png)



## Making your Putty



## Magnetic Putty Activity: Stage 1

- Now that we know the reaction that is occurring, we can make some putty!
- Here's what it will look like before we magnetize it:



## 3D Printing



## Typical Polymers used in 3D Printing

- There are two common polymers used in 3D printing:
  1. PLA (Polylactic Acid)
  2. ABS
- Both are thermoplastics
  - This means that they are soft and moldable when they are heated. They return to a solid when cooled and the process can be repeated infinite times.
- There are differences in strength, flexibility, temperature resistance, gloss and other characteristics that allow an engineer to choose which one is the best for the specific part.



Source: <https://3dprint.com.au/news/3d-printing-materials-what-to-use-when-choosing-a-material-for-3d-printing/>, <http://www.3dprint.com.au/news/3d-printing-differences-between-pla-and-abs-for-3d-printing/>



## CSIRO: Biodegradable Polymer

- These are not the only materials that a 3D printer can print!
- CSIRO research scientist Dr. Anne Ammala investigated a biodegradable polymer that can be 3D printed into intricate structures.



Source: <http://www.ecomagazine.com/?paper=EC13276>



## CSIRO Science: 3D Titanium Printing

CSIRO has recently established an Arcam additive manufacturing facility, the first in the southern hemisphere, to provide industry with access to advanced **electron beam melting** technologies for three-dimensional (3D) printing of metals.

How it works: <http://youtu.be/OSIImvwfNns>



Source: <http://www.csiro.au/Organisation-Structure/Fleetships/Future-Manufacturing-Fleetship/THTechnologies/Arcam.aspx>  
<http://www.csiro.au/en/Research/MF/Areas/Metals/Lab22>  
<https://csironewsblog.files.wordpress.com/2015/09/3d-printed-sternum-illustration.jpg>



## TinkerCAD



## Personalizing Your Case

- Search for TinkerCAD on your laptops
- Complete the Tutorials
- Personalize as you wish
  - Use the shapes to create a design and add your name

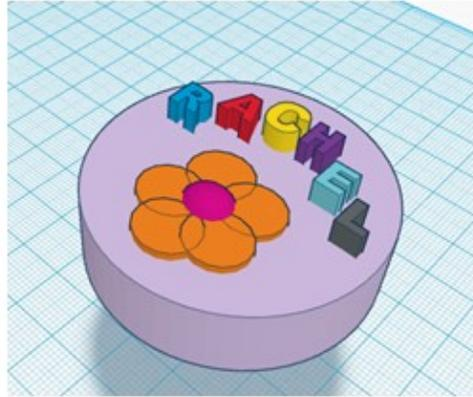

## Oil Spills



## Oil Spills Per Year

Even though the number of oil spills have significantly decreased the few spills that still occur are still destructive to ocean wildlife around the world.

Year	7-700 Tonnes	>700 Tonnes
2010	5	4
2011	5	1
2012	7	0
2013	5	3
2014	4	1
<b>Total</b>	<b>26</b>	<b>9</b>
<b>Average</b>	<b>5.2</b>	<b>1.8</b>





## BP Oil Spill- Largest Spill in History

- 200 million gallons of crude oil pumped into the gulf of mexico over 87 days
- 30,000 people responded to help collect oil and clean wildlife

OILED WILDLIFE		
	CONFIRMED # DEAD	TOTAL IMPACTED
 BIRDS	<b>6104</b>	<b>8184</b>
 SEA TURTLES	<b>605</b>	<b>1140</b>
 MARINE MAMMALS	<b>97</b>	<b>106</b>

\*The numbers above reflect only wildlife that have been recovered, actual numbers of dead and injured wildlife are likely to be much higher.  
Visit <http://defendersblog.org> for more information

<http://www.defendersblog.com/2010/08/200-million-gallons-of-crude-oil-spill/> <http://www.defendersblog.com/facts-0-2-facts-about-oil-spill/>



## Feather Demo



**Table 19:** Comparisons between the two methods for the clean(s)ing of one bird (penguin) contaminated with different contamination coverage (10 and 50%) for Diesel Oil and Bunker Oil. Removal of the detergent-based cleaning is undetermined and assumed to be ca. 100%.

Method	Removal (%)	Clean(s)ing time (min)	Iron powder used (kg)	Water used (L)	Detergent used (mL)	Pre-treatment used (mL)	Waste water created (L)	Contaminant laden iron powder created (kg)	Total cost (\$/bird)
10% Diesel Oil coverage									
Detergent-based cleaning	assumed 100	15.3		140	270		140		62.97
Magnetic cleansing	92.5	26.5	0.17					0.18	24.52

Source: <https://www.epa.gov.au/environment/marine-environmental-remediation/regional-oil-spill-contingency/documents/magnetic-cleansing-report.pdf>



# Bootcamp: Magnetic Ferrofluid

January 2016

WWW.CSIRO.AU

CSIRO EDUCATION AND OUTREACH



CSIRO

## Magnetic Ferrofluid: Outline

- **Introduction Magnets, Ferrofluid, & Demonstration**
  - Background knowledge on the different types of magnets
  - Ferrofluid background knowledge
  - Ferrofluid demonstration with electromagnet sculpture
- **Experiment Safety, Procedures, & Hypothesis**
  - Instructors will explain the safety and procedure for the day
  - Students will form a hypothesis about the experiment
- **Design and Complete Experiment**
  - Design an experiment in groups of 3
  - Complete the experiment and make conclusions
- **Magnetize the Putty!**
  - Add the Iron Oxide
  - Competition



## Magnets and Ferrofluid



## Different Types of Magnets

- **Ceramic magnets** are commonly seen in refrigerator magnets.
  - Not very strong
  - Mostly made up of iron oxide in a ceramic composite
- **Alnico magnets** are stronger than ceramic magnets
  - Made from aluminum, nickel and cobalt
- Neodymium and samarium cobalt magnets are both forms of **rare earth metal magnets**
  - **Neodymium magnets** are made of iron boron and neodymium, a rare-earth element
  - **Samarium cobalt magnets** are simply cobalt and samarium, another rare-earth metal Stronger than the other two types



## Properties of Magnets

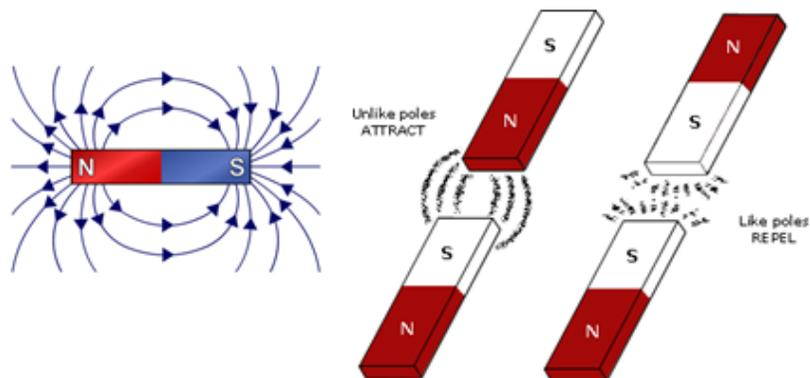

# Ferrofluid

Ferrofluids act like both a liquid and solid.

Under the influence of a magnet, a ferrofluid becomes solid

A ferrofluid contains tiny particles of magnetite or black iron oxide powder in a liquid medium.

The particles in the solution need to be kept separated.

A way to do this is by adding a surfactant



# Surfactant

The surfactants can generate either steric or electrostatic repulsions between the magnetic particles.

- Oleic acid can be used to produce steric repulsion.

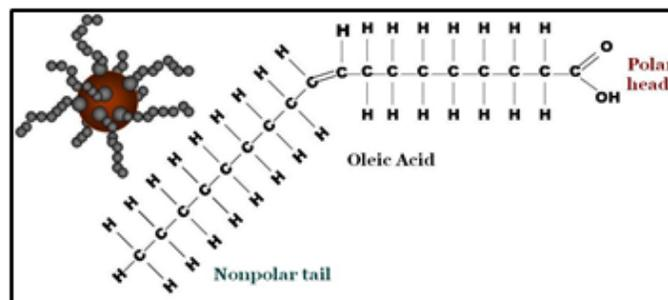
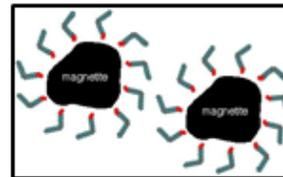

Sources: <http://www.web.utd.edu/~mkm9a/oleferrcomstojolec-WRS>, <http://education.msc.wisc.edu/~bdobson/ml/ferrofluid/mmses/magnetite1.jpg>



# Ferrofluid Oil Spill Experiment



## Form a Hypothesis

If [we do this], then [this will happen].

Form a hypothesis about how well using magnetic properties will work in cleaning up oil spills.



## Experiments

- Break into groups to design your experiment with the provided materials and form a hypothesis
- Get your experiment approved by an instructor
- Perform your experiment
- Make conclusions about how this could be applied to real oil spills



## Magnetic Silly Putty with Iron Oxide



## What is Black Iron Oxide Powder?

Black iron oxide exhibits permanent magnetism!



Naturally Occurring Iron Oxide (Magnetite)



Black Iron Oxide Powder



Source: [https://en.wikipedia.org/wiki/Iron\(II,III\)\\_oxide](https://en.wikipedia.org/wiki/Iron(II,III)_oxide)



## Magnetic Putty Overview

- Time to Magnetize your Putty! Here's what it should look like:





## Appendix S: Phone Speaker PowerPoint Presentation

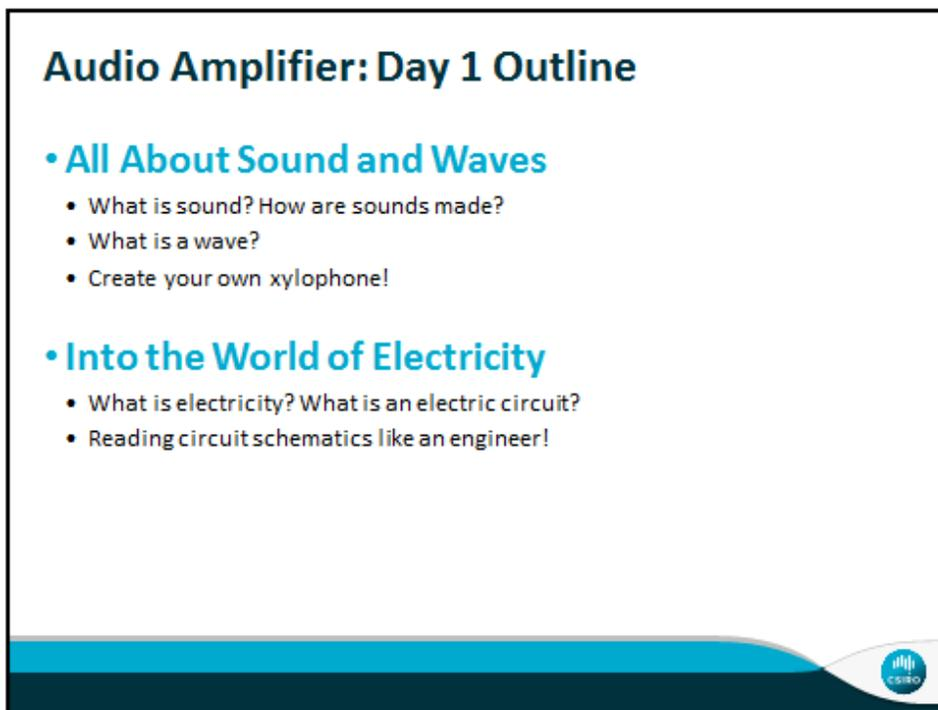
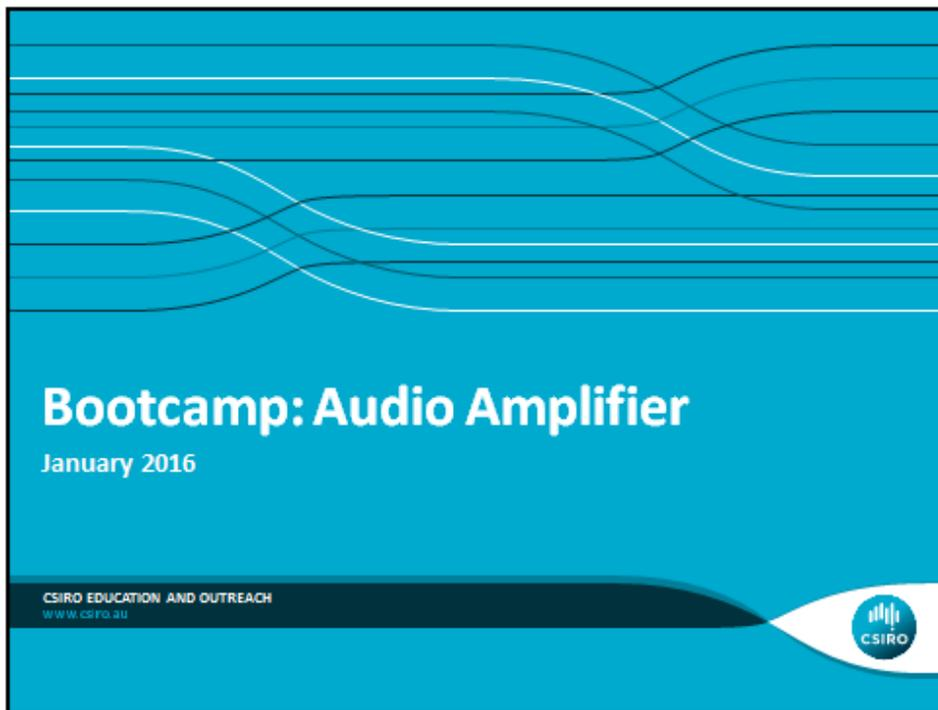

# Sound and Waves

Source: [http://indianapublicmedia.org/emoment/science/files/2013/10/22.2\\_musicrocks-940x626.jpg](http://indianapublicmedia.org/emoment/science/files/2013/10/22.2_musicrocks-940x626.jpg)



## What is Sound?



## What is Sound?

- Sound is a vibration which propagates as a pressure wave
- A sound source, i.e. your phone, generates a sound wave that pushes all molecules around it
- Each of these molecule pushes the ones around it and the wave travels until its energy is used up.
  - *You only hear a sound, if the energy is enough to keep molecules moving until the wave reaches your ear!*

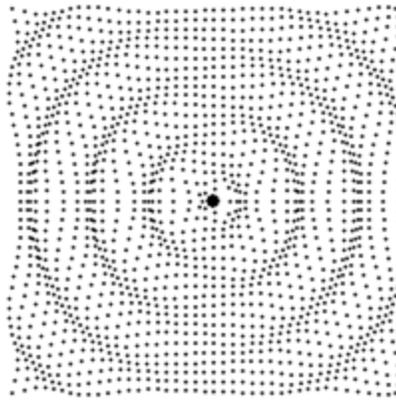

Source: <https://media.giphy.com/media/kTg0A3eM4g0pa/giphy.gif>



## What is Sound?

- When you speak, your vocal cords are simply compressing the air molecules around you

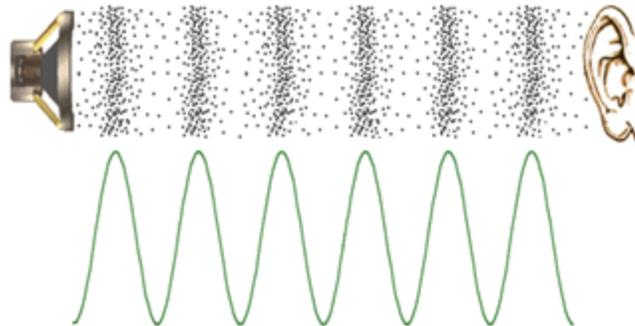

Source: <http://www.mediacollage.com/audio/images/loudspeaker-waveform.gif>



## How are Sounds Made?

Source: <http://www.justdrums.com/sounds.html>



## How are Sounds Made?

- Anything that moves or vibrates is a sound source
  - *Try blowing air into your ear with your hand. Your whole body is a sound source!*
  - *Could you have done the same on the moon?*
- Continuous sounds are made when an object vibrates back and forth



Source: <http://www.justdrums.com/sounds.html>



## What is a wave in science?



Source: <https://esda.intheital.com/wp-content/bloggs.dir/1/files/2012/10/occean-3.57x338.jpg>



## Waves

- Waves are disturbances that propagate energy through a medium
- Sound energy moves as one particle hits another particle
- We will get into more details during the Xylophone activity

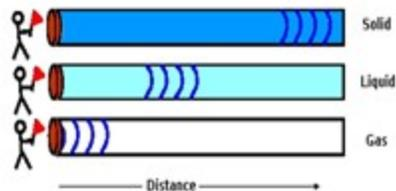

Source: <http://www.slideshare.net/bendampog/ultrasonic-spectroscopy>



## Waves with Slinky

There are two types of waves. Can you name them?



## Waves with Slinky

- The 2 types of waves are **transverse** and **longitudinal**
- Transverse - the particles vibrate at a **right angle** to the direction of the wave
- Longitudinal - the particles vibrate **parallel** to the direction of the wave

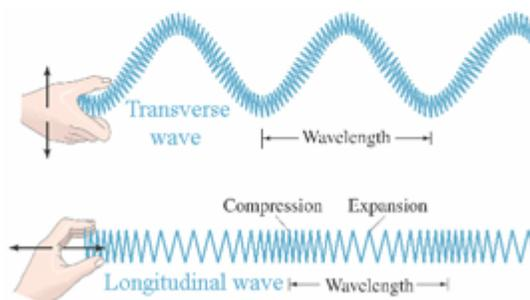

Source: <https://www.promedia.com/transverse-and-longitudinal-waves>



## Waves

Waves are defined by wavelength, frequency, and amplitude.

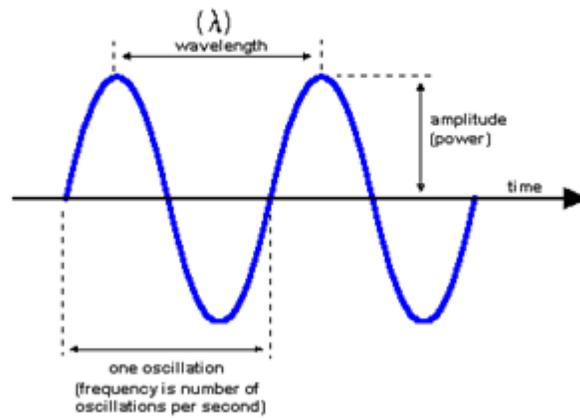

Source: <https://jasonson.wordpress.com/2014/10/14/amplitude-and-frequency/>



## Waves

There is an inverse relationship between wavelength and frequency.

$$\lambda = \frac{v}{f}$$

Where,

- $\lambda$  = Wavelength
- $v$  = Velocity of propagation
- $f$  = Frequency of signal



## Frequency and Pitch

Frequency is directly correlated to pitch.

Pitch is each person's *subjective perception* of a sound, which cannot be directly measured.

Humans can hear sounds with frequencies ranging from about 20Hz to 20,000Hz.

What about other animals?



## Frequency and Pitch

Frequency is directly correlated to pitch.

Pitch is each person's *subjective perception* of a sound, which cannot be directly measured.

Humans can hear sounds with frequencies ranging from about 20Hz to 20,000Hz.

What about other animals?

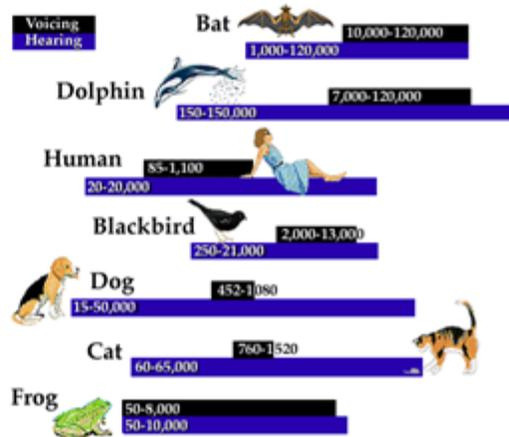

Source: [https://thelibraryofscience.files.wordpress.com/2011/12/hearing\\_range1.png](https://thelibraryofscience.files.wordpress.com/2011/12/hearing_range1.png)





# Making Music with Waves

Source: [http://indianapublicmedia.org/emomentoscience/files/2001/10/212\\_musicrota-940x528.jpg](http://indianapublicmedia.org/emomentoscience/files/2001/10/212_musicrota-940x528.jpg)



## Sounds Through Different Mediums

- The closer the molecules are to each other the less time it takes for them to pass the sound to each other and the faster sound can travel
- Elastic properties relate to the tendency of a material to maintain its shape and not deform when a force is applied to it. A material such as steel will experience a smaller deformation than rubber

$$V = \sqrt{\frac{C_{ij}}{\rho}}$$

Where:  $C_{ij}$  is the elastic properties and  $\rho$  is the density

Speed of Sound

Medium	Speed (m/s)
Air at 0°C	331
Air at 20°C	343
Water at 20°C	1482
Lead	1960
Glass	5640
Steel	5960

Source: <https://www.nidod.org/education/resources/highschool/sound/speedinmaterials.htm>



## Xylophone Activity

- Split into groups of 3
- Work within your team to create your assigned frequencies
- Use the following objects:
  - Beaker filled with water, 5 glass bottles, and 3 metal spoons



Sources: <http://www.thebidix.com/good-cooking-glass-bottle-110-g>  
<http://www.chemistryand.com/Chem/13011d04b/Leb7/Leb7.html>  
<http://www.promo-warehouse.com/custom/spoons/>



## Play Your Own Songs

- Choose a simple song your group wants to play and look-up the notes required
- Make the notes with your bottles to produce music!
- G ~ 1568 Hz
- A ~ 1760 Hz
- B ~ 1976 Hz
- C ~ 2093 Hz
- D ~ 2349 Hz
- E ~ 2637 Hz
- F ~ 2793 Hz



## CSIRO: Anechoic Chamber

- An anechoic chamber prevents the reflection of sound waves
- Used to accurately calibrate sound equipment
- Can cause disorientation in humans

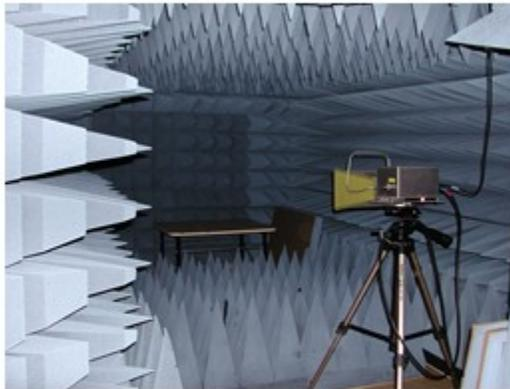

Source: <http://www.measurement.gov.au/SCIENCE/TECHNOLOGY/Pages/Acoustics,UltrasonidandVibrationResearch.aspx>



## CSIRO Research: RV Investigator

- Maps the ocean floor using sonar waves
- Supports Australia's atmospheric, oceanographic, biological, and geosciences research
- Analyses weather patterns with a meteorological radar system
- Tasked with deep sea oceanography, mapping and studying the geology of Australia's marine estate, and learning more about Australia's weather patterns



Source: <http://www.csiro.au/en/Research/Facilities/Marino-National-Facility/RV-Investigator>





## What is Electricity?

- Electricity is a natural phenomenon that occurs throughout nature and takes many different forms
- Current electricity is defined as **flow of electric charge**
- Electric charge is carried by *electrons*.
  - Materials through which electrons travel are called **conductors**, i.e. gold, silver
  - Materials through which electrons travel poorly are called **insulators**, i.e. glass, plastic



## Inside a Circuit

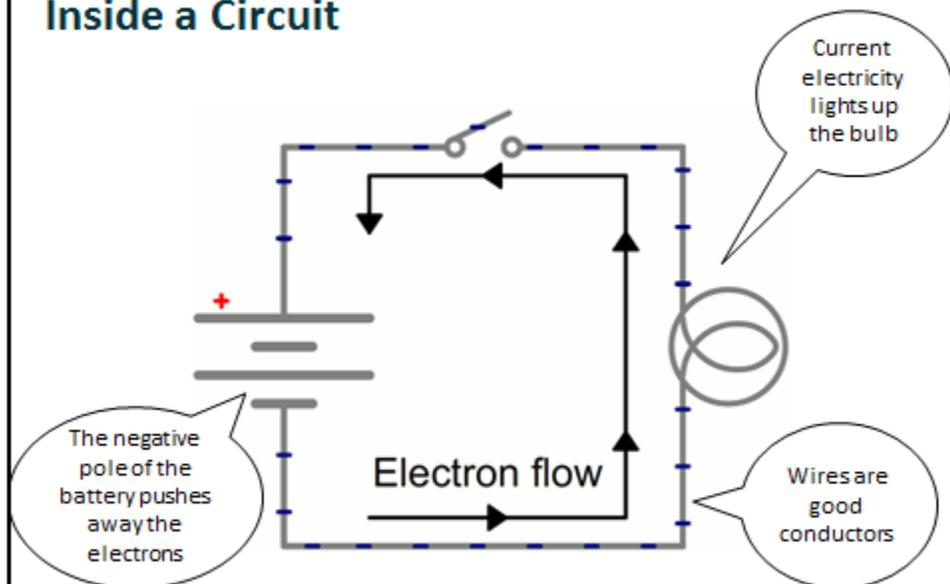

Source: <https://cdn.sparkfun.com/assets/a/0/9/4/0/31452b21-62ec59f272000001.gif>



## Draw your own circuit (Activity)

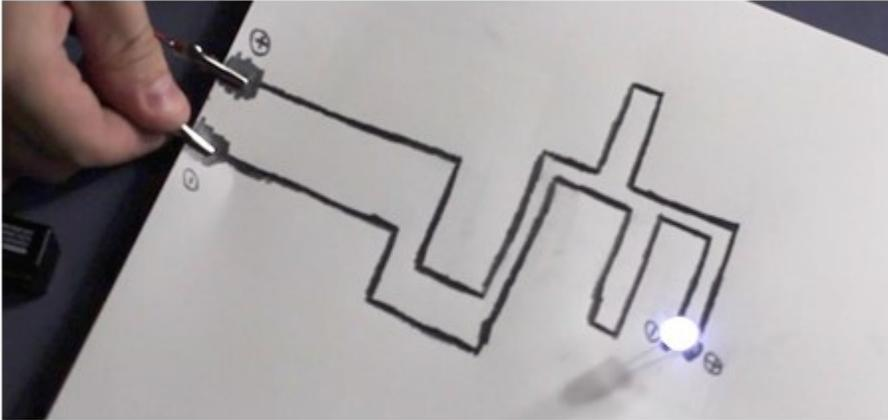

Source: <https://i.yimg.com/e/0wKQ9id4PM/mexrad5eulf.jpg>



## Electrical Appliances



## Electrical Appliances



Source: <http://www.top100.eco.com/wp-content/uploads/2014/05/computers.png>



## Electrical Appliances



Source: <http://www.the-geo.com/wp-content/uploads/2015/03/Smart-phones.jpg>



## Electrical Appliances



Source: [http://oc.images-amazon.com/images/I/61D05HLYL\\_31255.jpg](http://oc.images-amazon.com/images/I/61D05HLYL_31255.jpg)



## Electrical Appliances



Source: <http://on.dhungtop.com/>





## Sources of Electricity:

- Main electricity
- Electric cells (batteries)



### Mains Electricity

- Generated by power stations
- Wires transfer the electricity
- Connect to mains sockets
- Supply a lot electrical energy



Source: <http://www.bwfgroup.de/en/bwf-energies/applications/coal-fired-power-plants.html>

<http://www.eccasfixtura.com/wp-content/uploads/2014/11/wallsocket-027-250-m.jpg>



## Electric Cells

- Usually used with small portable devices



- Supply small amount of energy
- Necessary to create our speaker circuit

Source: <http://www.picstop.co.uk/skin/frontend/picstop/MAG080318/image/6x10pics.jpg>



## Basic Concepts of Electricity

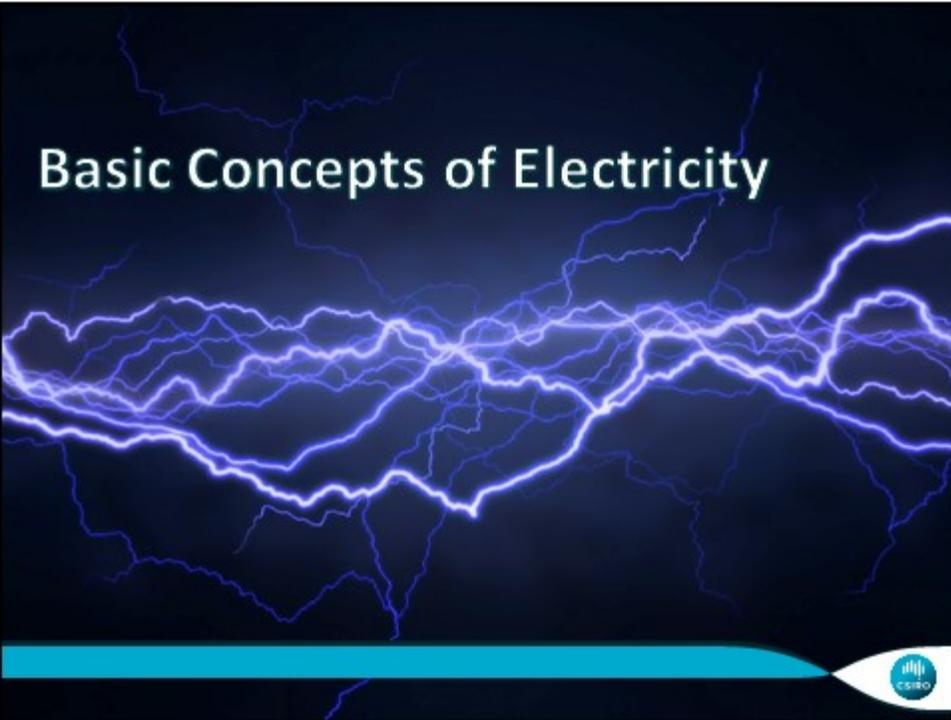

## Basic Concepts of Electricity

Key Term	Unit	Definition
Charge (Q)	Ampere (A)	Measurement of how a component reduces the electric current.
Current (I)	Ohm ( $\Omega$ )	The work performed by an electrical current.
Voltage (V)	Coulomb (C)	The fundamental electric quantity.
Resistance (R)	Volt (V)	The electrical pressure. Also sometimes referred to as potential.
Power (P)	Watt (W)	The quantity of electrons passing a given point.



## Basic Concepts of Electricity

Key Term	Unit	Definition
Charge (Q)	Ampere (A)	Measurement of how a component reduces the electric current.
Current (I)	Ohm ( $\Omega$ )	The work performed by an electrical current.
Voltage (V)	Coulomb (C)	The fundamental electric quantity.
Resistance (R)	Volt (V)	The electrical pressure. Also sometimes referred to as potential.
Power (P)	Watt (W)	The quantity of electrons passing a given point.



# Basic Concepts of Electricity

Key Term	Unit	Definition
Charge (Q)	Ampere (A)	Measurement of how a component reduces the electric current.
Current (I)	Ohm ( $\Omega$ )	The work performed by an electrical current.
Voltage (V)	Coulomb (C)	The fundamental electric quantity.
Resistance (R)	Volt (V)	The electrical pressure. Also sometimes referred to as potential.
Power (P)	Watt (W)	The quantity of electrons passing a given point.



# Current-Water Analogy

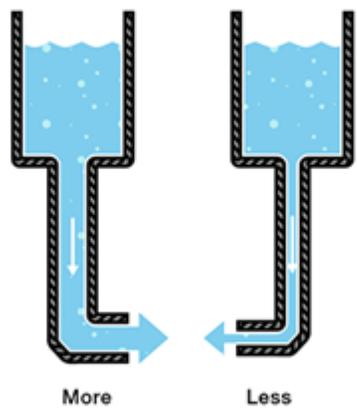

Source: <https://cdn.sparkfun.com/assets/4/0/2/4/0/51a52b63-cd95f2f25000003.gif>



## Basic Concepts of Electricity

Key Term	Unit	Definition
Charge (Q)	Ampere (A)	Measurement of how a component reduces the electric current.
Current (I)	Ohm ( $\Omega$ )	The work performed by an electrical current.
Voltage (V)	Coulomb (C)	The fundamental electric quantity.
Resistance (R)	Volt (V)	The electrical pressure. Also sometimes referred to as potential.
Power (P)	Watt (W)	The quantity of electrons passing a given point.



## Basic Concepts of Electricity

Key Term	Unit	Definition
Charge (Q)	Ampere (A)	Measurement of how a component reduces the electric current.
Current (I)	Ohm ( $\Omega$ )	The work performed by an electrical current.
Voltage (V)	Coulomb (C)	The fundamental electric quantity.
Resistance (R)	Volt (V)	The electrical pressure. Also sometimes referred to as potential.
Power (P)	Watt (W)	The quantity of electrons passing a given point.



## Voltage-Water Analogy

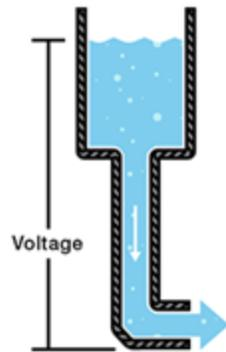

Source: [https://cdn.sparkfun.com/assets/a/0/3/4/0/51403182cc99f7a2000000\\_gif](https://cdn.sparkfun.com/assets/a/0/3/4/0/51403182cc99f7a2000000_gif)



## Basic Concepts of Electricity

Key Term	Unit	Definition
Charge (Q)	Ampere (A)	Measurement of how a component reduces the electric current.
Current (I)	Ohm ( $\Omega$ )	The work performed by an electrical current.
Voltage (V)	Coulomb (C)	The fundamental electric quantity.
Resistance (R)	Volt (V)	The electrical pressure. Also sometimes referred to as potential.
Power (P)	Watt (W)	The quantity of electrons passing a given point.



## Basic Concepts of Electricity

Key Term	Unit	Definition
Charge (Q)	Ampere (A)	Measurement of how a component reduces the electric current.
Current (I)	Ohm ( $\Omega$ )	The work performed by an electrical current.
Voltage (V)	Coulomb (C)	The fundamental electric quantity.
Resistance (R)	Volt (V)	The electrical pressure. Also sometimes referred to as potential.
Power (P)	Watt (W)	The quantity of electrons passing a given point.



## Resistors-Water Analogy

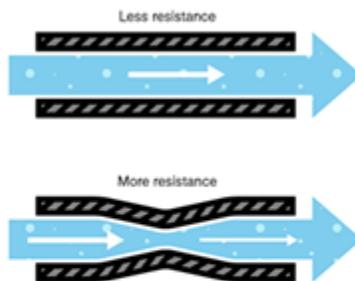

Source: <https://cdn.sparkfun.com/assets/a/0/3/4/b/5147262cc99f215000001.gif>



## Basic Concepts of Electricity

Key Term	Unit	Definition
Charge (Q)	Ampere (A)	Measurement of how a component reduces the electric current.
Current (I)	Ohm ( $\Omega$ )	The work performed by an electrical current.
Voltage (V)	Coulomb (C)	The fundamental electric quantity.
Resistance (R)	Volt (V)	The electrical pressure. Also sometimes referred to as potential.
Power (P)	Watt (W)	The quantity of electrons passing a given point.



## Basic Concepts of Electricity

Key Term	Unit	Definition
Charge (Q)	Ampere (A)	Measurement of how a component reduces the electric current.
Current (I)	Ohm ( $\Omega$ )	The work performed by an electrical current.
Voltage (V)	Coulomb (C)	The fundamental electric quantity.
Resistance (R)	Volt (V)	The electrical pressure. Also sometimes referred to as potential.
Power (P)	Watt (W)	The quantity of electrons passing a given point.





## Power-Water Analogy

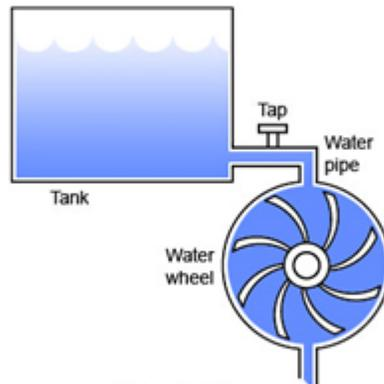

Source: [https://cdn.sparkfun.com/assets/4/0/9/4/0/3145316200995f2f2000000\\_gif](https://cdn.sparkfun.com/assets/4/0/9/4/0/3145316200995f2f2000000_gif)



## Ohm's Law

Combining the elements of voltage, current, and resistance. Ohm developed the formula:

$$V = I \times R$$

Where

- V = Voltage in volts (V)
- I = Currents in amperes (A)
- R = Resistance in ohms ( $\Omega$ )

Any two can give the power produced by the circuit:

$$P = V \times I = I^2 \times R = \frac{V^2}{R}$$



# Electric Circuits

Source: <https://s-media-cache-ak0.pinimg.com/736x/7b/69/91/7b6991283cc0a021530cb956a5c74b07.jpg>

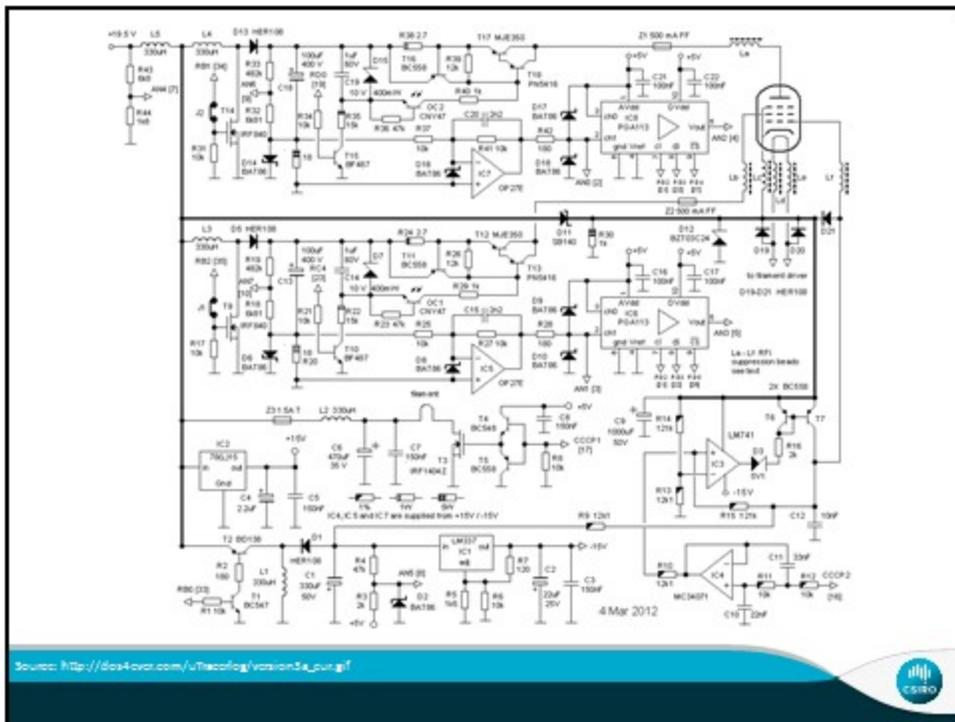

Source: [http://ds4civar.com/u/theafog/vision3a\\_pwr.gif](http://ds4civar.com/u/theafog/vision3a_pwr.gif)



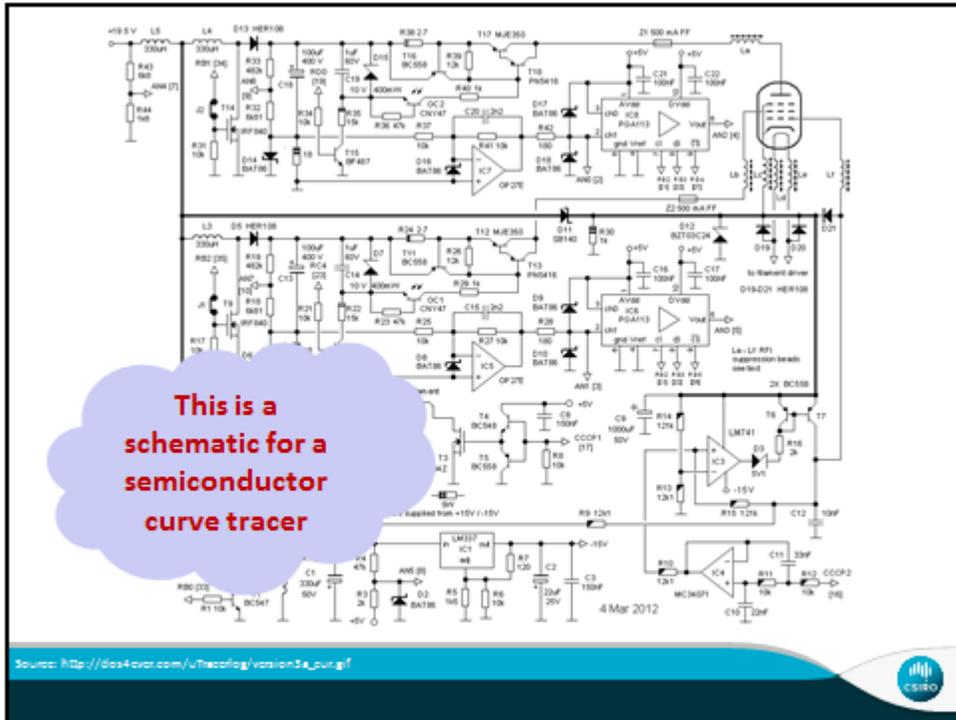

Component	Symbol
Battery	
Wire	
Resistor	
Potentiometer	
Capacitor	
Speaker	
Op-Amp	

## Resistor Color Code

Color	1 <sup>st</sup> Band	2 <sup>nd</sup> Band	3 <sup>rd</sup> Band	Multiplier	Tolerance
Black	0	0	0	x 1 Ω	
Brown	1	1	1	x 10 Ω	+/- 1%
Red	2	2	2	x 100 Ω	+/- 2%
Orange	3	3	3	x 1K Ω	
Yellow	4	4	4	x 10K Ω	
Green	5	5	5	x 100K Ω	+/- 5%
Blue	6	6	6	x 1M Ω	+/- 25%
Violet	7	7	7	x 10M Ω	+/- .1%
Grey	8	8	8		+/- .05%
White	9	9	9		
Gold				x .1 Ω	+/- 5%
Silver				x .01 Ω	+/- 10%

Source: [http://ncsrbva.net/wiki/images/1/14/Resistor\\_color\\_codes.jpg](http://ncsrbva.net/wiki/images/1/14/Resistor_color_codes.jpg)

## Resistance Color Code

Color	1 <sup>st</sup> Band	2 <sup>nd</sup> Band	3 <sup>rd</sup> Band	Multiplier	Tolerance
Black	0	0	0	x 1 Ω	
Brown	1	1	1	x 10 Ω	+/- 1%
Red	2	2	2	x 100 Ω	+/- 2%
Orange	3	3	3	x 1K Ω	
Yellow	4	4	4	x 10K Ω	
Green	5	5	5	x 100K Ω	+/- 5%
Blue	6	6	6	x 1M Ω	+/- 25%
Violet	7	7	7	x 10M Ω	+/- .1%
Grey	8	8	8		+/- .05%
White	9	9	9		
Gold				x .1 Ω	+/- 5%
Silver				x .01 Ω	+/- 10%

## Resistance Color Code

Color	1 <sup>st</sup> Band	2 <sup>nd</sup> Band	3 <sup>rd</sup> Band	Multiplier	Tolerance
Black	0	0	0	x 1 Ω	
Brown	1	1	1	x 10 Ω	+/- 1%
Red	2	2	2	x 100 Ω	+/- 2%
Orange	3	3	3	x 1K Ω	
Yellow	4	4	4	x 10K Ω	
Green	5	5	5	x 100K Ω	+/- 0.5%
Blue	6	6	6	x 1M Ω	+/- 0.25%
Violet	7	7	7	x 10M Ω	+/- .1%
Grey	8	8	8		+/- .05%
White	9	9	9		
Gold				x .1 Ω	+/- 5%
Silver				x .01 Ω	+/- 10%

- 4-Band Resistor



## Resistance Color Code

Color	1 <sup>st</sup> Band	2 <sup>nd</sup> Band	3 <sup>rd</sup> Band	Multiplier	Tolerance
Black	0	0	0	x 1 Ω	
Brown	1	1	1	x 10 Ω	+/- 1%
Red	2	2	2	x 100 Ω	+/- 2%
Orange	3	3	3	x 1K Ω	
Yellow	4	4	4	x 10K Ω	
Green	5	5	5	x 100K Ω	+/- 0.5%
Blue	6	6	6	x 1M Ω	+/- 0.25%
Violet	7	7	7	x 10M Ω	+/- .1%
Grey	8	8	8		+/- .05%
White	9	9	9		
Gold				x .1 Ω	+/- 5%
Silver				x .01 Ω	+/- 10%

- 4-Band Resistor



Source: [http://www.yildiz.edu.tr/~yildiz/malik/tominoaj\\_bolum5.pdf](http://www.yildiz.edu.tr/~yildiz/malik/tominoaj_bolum5.pdf)

## Resistance Color Code

Color	1 <sup>st</sup> Band	2 <sup>nd</sup> Band	3 <sup>rd</sup> Band	Multiplier	Tolerance
Black	0	0	0	x 1 Ω	
Brown	1	1	1	x 10 Ω	+/- 1%
Red	2	2	2	x 100 Ω	+/- 2%
Orange	3	3	3	x 1K Ω	
Yellow	4	4	4	x 10K Ω	
Green	5	5	5	x 100K Ω	+/- 5%
Blue	6	6	6	x 1M Ω	+/- 25%
Violet	7	7	7	x 10M Ω	+/- 1%
Grey	8	8	8		+/- .05%
White	9	9	9		
Gold				x .1 Ω	+/- 5%
Silver				x .01 Ω	+/- 10%



- 4-Band Resistor
- Wrong way!!



## Resistance Color Code

Color	1 <sup>st</sup> Band	2 <sup>nd</sup> Band	3 <sup>rd</sup> Band	Multiplier	Tolerance
Black	0	0	0	x 1 Ω	
Brown	1	1	1	x 10 Ω	+/- 1%
Red	2	2	2	x 100 Ω	+/- 2%
Orange	3	3	3	x 1K Ω	
Yellow	4	4	4	x 10K Ω	
Green	5	5	5	x 100K Ω	+/- 5%
Blue	6	6	6	x 1M Ω	+/- 25%
Violet	7	7	7	x 10M Ω	+/- 1%
Grey	8	8	8		+/- .05%
White	9	9	9		
Gold				x .1 Ω	+/- 5%
Silver				x .01 Ω	+/- 10%



- 4-Band Resistor
- Wrong way!!
- Gold/Silver = right side of resistor
- We read from left to right



## Resistance Color Code

Color	1 <sup>st</sup> Band	2 <sup>nd</sup> Band	3 <sup>rd</sup> Band	Multiplier	Tolerance
Black	0	0	0	x 1 Ω	
Brown	1	1	1	x 10 Ω	+/- 1%
Red	2	2	2	x 100 Ω	+/- 2%
Orange	3	3	3	x 1K Ω	
Yellow	4	4	4	x 10K Ω	
Green	5	5	5	x 100K Ω	+/- 5%
Blue	6	6	6	x 1M Ω	+/- 25%
Violet	7	7	7	x 10M Ω	+/- .1%
Grey	8	8	8		+/- .05%
White	9	9	9		
Gold				x .1 Ω	+/- 5%
Silver				x .01 Ω	+/- 10%

- 4-Band Resistor



## Resistance Color Code

Color	1 <sup>st</sup> Band	2 <sup>nd</sup> Band	3 <sup>rd</sup> Band	Multiplier	Tolerance
Black	0	0	0	x 1 Ω	
Brown	1	1	1	x 10 Ω	+/- 1%
Red	2	2	2	x 100 Ω	+/- 2%
Orange	3	3	3	x 1K Ω	
Yellow	4	4	4	x 10K Ω	
Green	5	5	5	x 100K Ω	+/- 5%
Blue	6	6	6	x 1M Ω	+/- 25%
Violet	7	7	7	x 10M Ω	+/- .1%
Grey	8	8	8		+/- .05%
White	9	9	9		
Gold				x .1 Ω	+/- 5%
Silver				x .01 Ω	+/- 10%

- 4-Band Resistor
- 1<sup>st</sup> digit Violet = 7



## Resistance Color Code

Color	1 <sup>st</sup> Band	2 <sup>nd</sup> Band	3 <sup>rd</sup> Band	Multiplier	Tolerance
Black	0	0	0	x 1 Ω	
Brown	1	1	1	x 10 Ω	+/- 1%
Red	2	2	2	x 100 Ω	+/- 2%
Orange	3	3	3	x 1K Ω	
Yellow	4	4	4	x 10K Ω	
Green	5	5	5	x 100K Ω	+/- 5%
Blue	6	6	6	x 1M Ω	+/- 25%
Violet	7	7	7	x 10M Ω	+/- 1%
Grey	8	8	8		+/- .05%
White	9	9	9		
Gold				x .1 Ω	+/- 5%
Silver				x .01 Ω	+/- 10%



- 4-Band Resistor
- 1<sup>st</sup> digit Violet = 7
- 2<sup>nd</sup> digit Green = 5



## Resistance Color Code

Color	1 <sup>st</sup> Band	2 <sup>nd</sup> Band	3 <sup>rd</sup> Band	Multiplier	Tolerance
Black	0	0	0	x 1 Ω	
Brown	1	1	1	x 10 Ω	+/- 1%
Red	2	2	2	x 100 Ω	+/- 2%
Orange	3	3	3	x 1K Ω	
Yellow	4	4	4	x 10K Ω	
Green	5	5	5	x 100K Ω	+/- 5%
Blue	6	6	6	x 1M Ω	+/- 25%
Violet	7	7	7	x 10M Ω	+/- 1%
Grey	8	8	8		+/- .05%
White	9	9	9		
Gold				x .1 Ω	+/- 5%
Silver				x .01 Ω	+/- 10%



- 4-Band Resistor
- 1<sup>st</sup> digit Violet = 7
- 2<sup>nd</sup> digit Green = 5
- Multiplier Brown = 10





## Resistance Color Code

Color	1 <sup>st</sup> Band	2 <sup>nd</sup> Band	3 <sup>rd</sup> Band	Multiplier	Tolerance
Black	0	0	0	x 1 Ω	
Brown	1	1	1	x 10 Ω	+/- 1%
Red	2	2	2	x 100 Ω	+/- 2%
Orange	3	3	3	x 1K Ω	
Yellow	4	4	4	x 10K Ω	
Green	5	5	5	x 100K Ω	+/- 5%
Blue	6	6	6	x 1M Ω	+/- 25%
Violet	7	7	7	x 10M Ω	+/- .1%
Grey	8	8	8		+/- .05%
White	9	9	9		
Gold				x .1 Ω	+/- 5%
Silver				x .01 Ω	+/- 10%



- 4-Band Resistor
- 1<sup>st</sup> digit Violet = 7
- 2<sup>nd</sup> digit Green = 5
- Multiplier Brown = 10
- $75 \cdot 10\Omega = 750 \Omega$



## Resistance Color Code

Color	1 <sup>st</sup> Band	2 <sup>nd</sup> Band	3 <sup>rd</sup> Band	Multiplier	Tolerance
Black	0	0	0	x 1 Ω	
Brown	1	1	1	x 10 Ω	+/- 1%
Red	2	2	2	x 100 Ω	+/- 2%
Orange	3	3	3	x 1K Ω	
Yellow	4	4	4	x 10K Ω	
Green	5	5	5	x 100K Ω	+/- 5%
Blue	6	6	6	x 1M Ω	+/- 25%
Violet	7	7	7	x 10M Ω	+/- .1%
Grey	8	8	8		+/- .05%
White	9	9	9		
Gold				x .1 Ω	+/- 5%
Silver				x .01 Ω	+/- 10%



- 4-Band Resistor
- 1<sup>st</sup> digit Violet = 7
- 2<sup>nd</sup> digit Green = 5
- Multiplier Brown = 10
- $75 \cdot 10\Omega = 750 \Omega$
- 5% Tolerance



# Day 1 Recap



## Audio Amplifier: Day 2 Outline

### • Resistor Substitution and Breadboard

- What if I need a resistance value that I don't have?
- How do I use a breadboard?

### • Create an Audio Amplifier

- Get the circuit schematic, read it and..
- Create a working audio amplifier!
- Test the amplifier *and use household materials to improve it*

### • Use TinkerCAD to Design Name Plate

- Use a computer to learn TinkerCAD
- Personalise your nameplate



## Combining Resistors

In Series

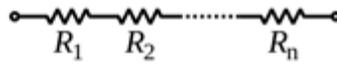

$$R_{\text{total}} = R_1 + R_2 + \dots + R_n$$

In Parallel

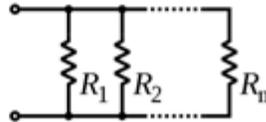

$$\frac{1}{R_{\text{total}}} = \frac{1}{R_1} + \frac{1}{R_2} + \dots + \frac{1}{R_n}$$



## Example of resistor substitution

1



Answer: ...  $\Omega$

2

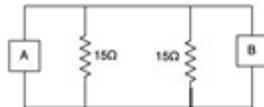

Answer: ...  $\Omega$

3

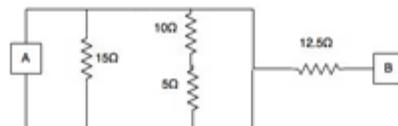

Answer: ...  $\Omega$



## Example of resistor substitution

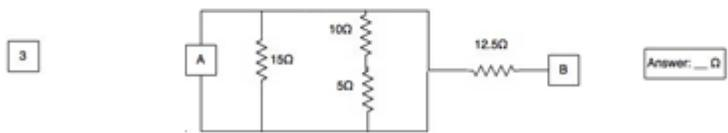
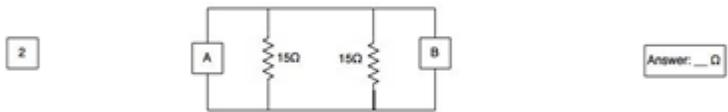
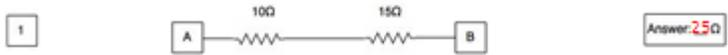

## Example of resistor substitution

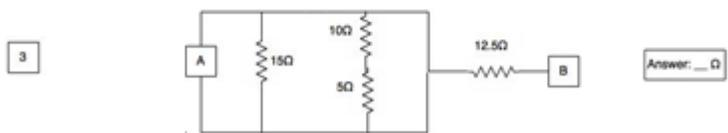
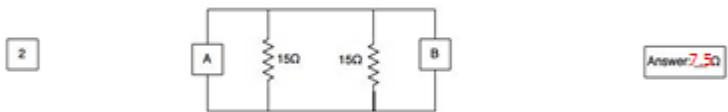
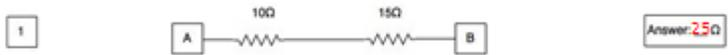

## Example of resistor substitution

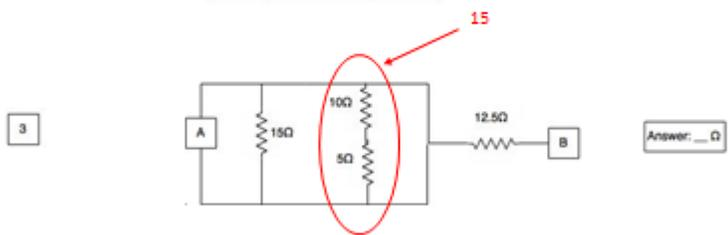
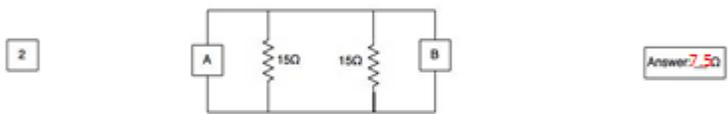
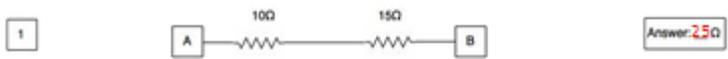

## Example of resistor substitution

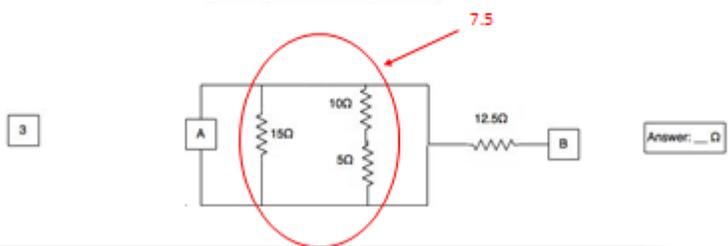
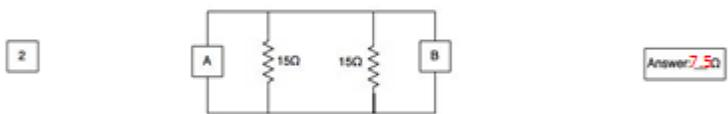
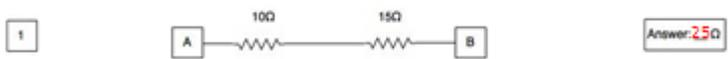

## Example of resistor substitution

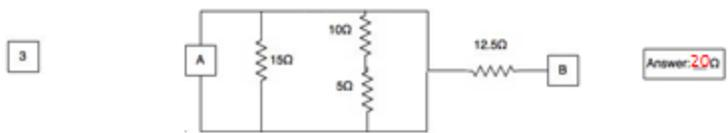
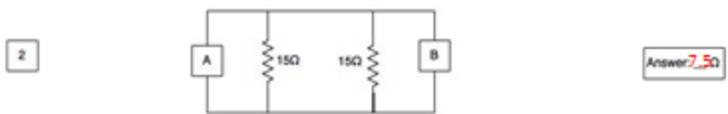
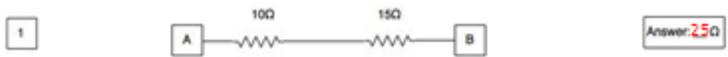

## Connecting Components

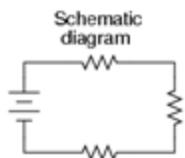
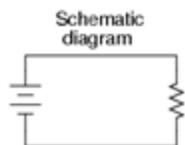

Source: <http://www.allaboutcircuits.com/textbook/direct-current/chpt5/building-simple-resistor-circuits/>



## Connecting Components

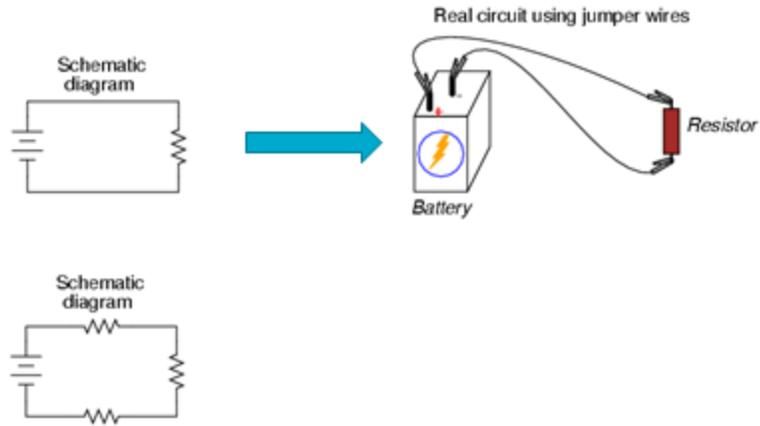

Source: <http://www.allaboutcircuits.com/textbook/directcurrent/chp13/buildingsimple-resistor-circuits/>



## Connecting Components

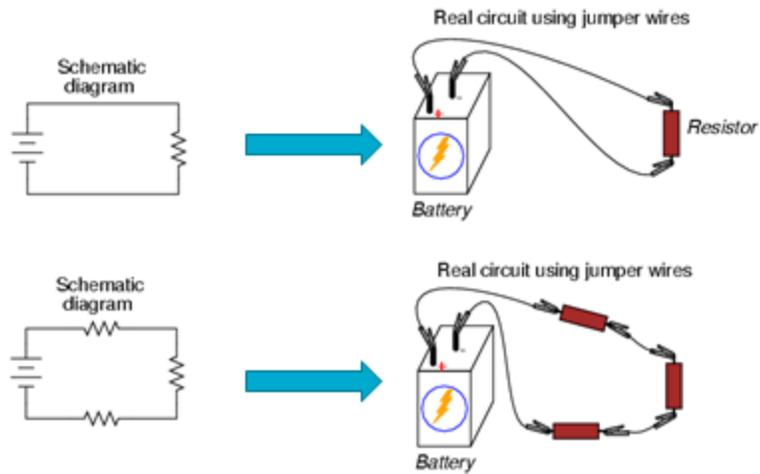

Source: <http://www.allaboutcircuits.com/textbook/directcurrent/chp13/buildingsimple-resistor-circuits/>



## How does a breadboard work?

Lines show common connections underneath board between holes

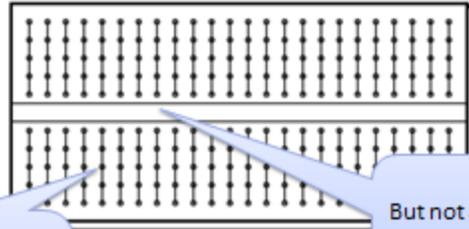

Holes are linked vertically (use middle divider for reference) as shown

But not across the middle divider

Source: <http://www.allaboutcircuits.com/textbook/electronics/chp15/buildingsimple-resistor-circuits/>



## How does a breadboard work?

Once inserted, a component will be electrically connected to anything else placed in the same line...

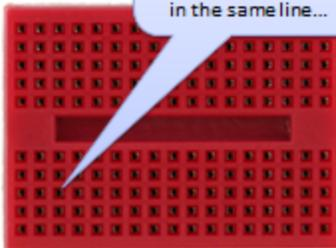

Source: <https://cdn.sparkfun.com/assets/4/7/7/4/c/9375cd00cd9d5e49000004.jpg>





## How does a breadboard work?

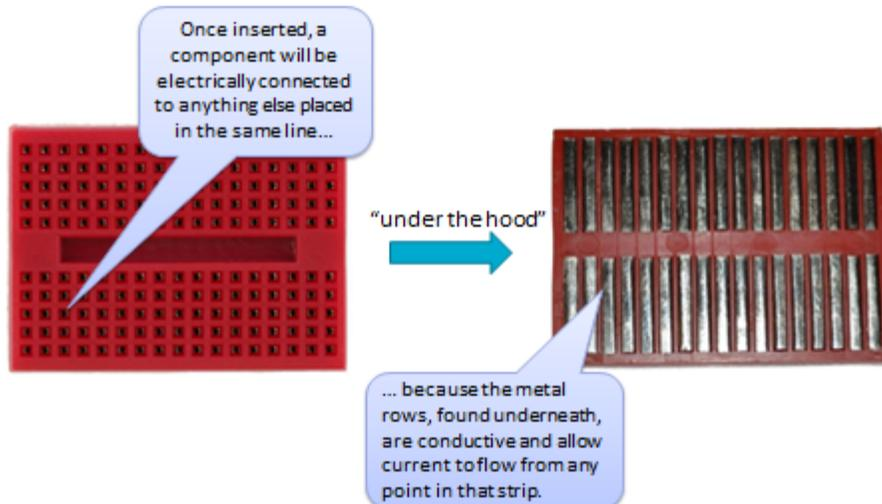

Source: <https://cdn.sparkfun.com/assets/c/7/7/A/c/5/3/5ct00c595f54900004.jpg>



## Connecting Components to Breadboard

### In Series

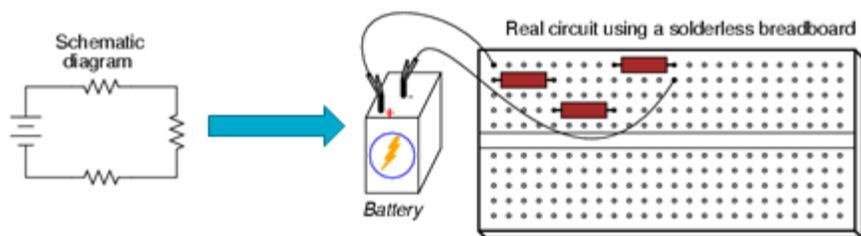

Source: <http://www.allaboutcircuits.com/textbook/directcurrent/chp15/buildingsimpleristencircuits/>



## Connecting Components to Breadboard

### In Series

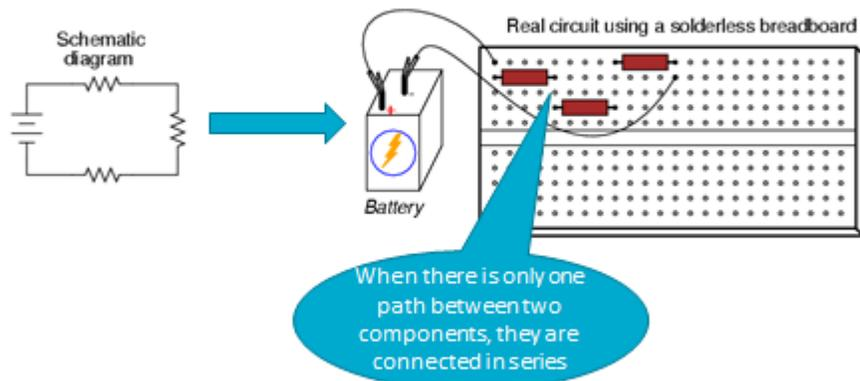

Source: <http://www.allaboutcircuits.com/text/book/direction/chpt5/buildingsimpler-circuits/>



## Connecting Components to Breadboard

### In Parallel

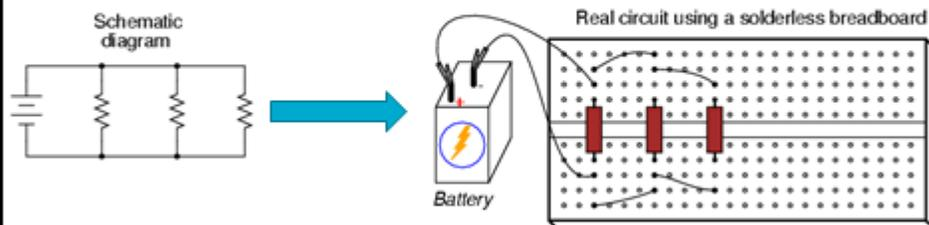

Source: <http://www.allaboutcircuits.com/text/book/direction/chpt5/buildingsimpler-circuits/>



## Connecting Components to Breadboard

### In Parallel

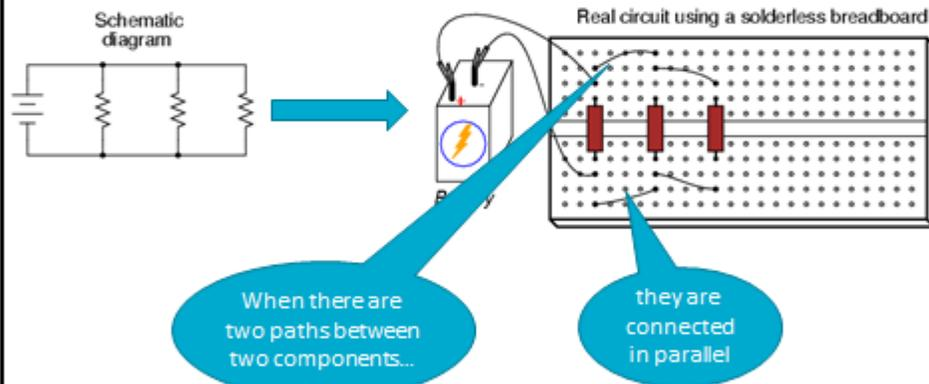

Source: <http://www.allaboutcircuits.com/textbook/direct-current/chp15/building-simple-resistor-circuits/>



## Investigating Circuitry (Group Activity)

- Split into groups of 3
- You have 9V battery, a breadboard, resistors and wires
- Create a circuit with:
  - Resistors in series
  - Resistors in parallel
  - Combination of the two
- If you are already familiar with the process, try the *resistor challenge!*



## Create your own Audio Amplifier!

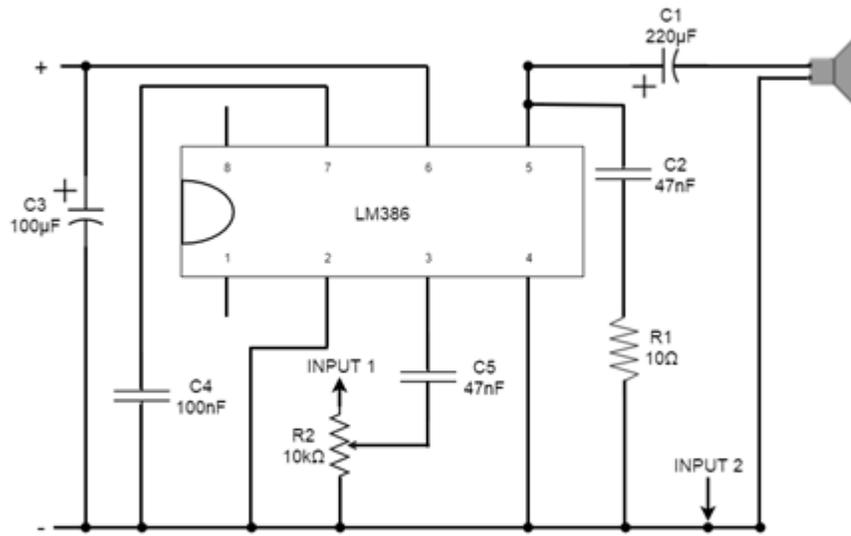

Source: <https://cdn.sparkfun.com/assets/4/0/2/4/0/51a22b82cc393f2f25000001.gif>



## 3D Printed Nameplate



## CSIRO Science: 3D Titanium Printing

CSIRO has recently established an Arcam additive manufacturing facility, the first in the southern hemisphere, to provide industry with access to advanced **electron beam melting** technologies for three-dimensional (3D) printing of metals.

**How it works:** <http://youtu.be/OSIImvwfNns>

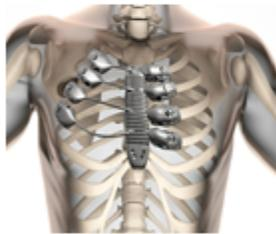

Source: <http://www.csiro.au/Organisation-Structure/Flagships/Future-Manufacturing-Flagship/Ti-Technology/Arcam.aspx>

<https://airnewsblog.files.wordpress.com/2015/09/3d-printed-stomach-illustration.jpg>

<http://www.csiro.au/en/facilities/MF/Aras/Metals/Lab22>



## TinkerCAD

**Top Toolbar**  
Find undo, align and grouping options here

**Inspector**  
Change shape type between solid and hole

**Design menu**  
Download your finished file for 3D printing from here

**Import**  
This is where you will load the case cover file

**RHS Toolbar**  
Find shapes and letters here

**Workplane**  
Design your model here



# Recap



## Appendix T: Step By Step Instructions for Circuit Assembly

Step 1: Select the power rails (the rows connected to the positive and negative terminals of the power supply) for your circuit by plugging in the battery clip (but don't plug in the battery). The power rails are best put at the top of the breadboard.

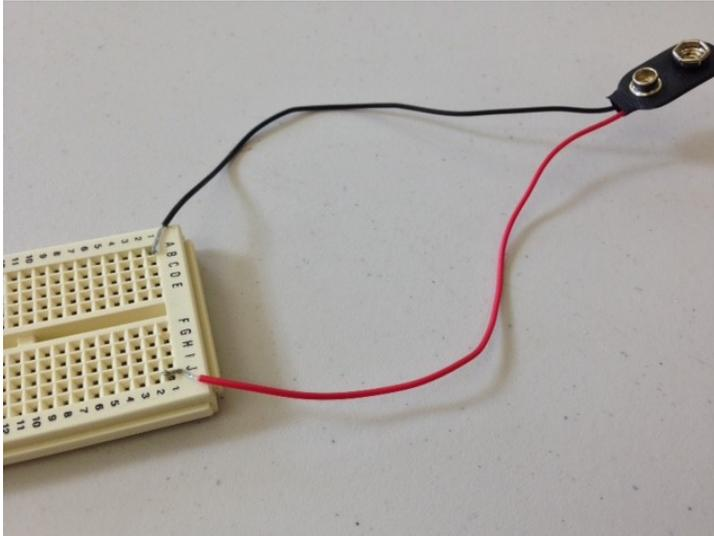

Step 2: Plug in your LM386 operation amplifier. It should fit into the columns adjacent to the gap in the middle of the breadboard and along 4 consecutive rows.

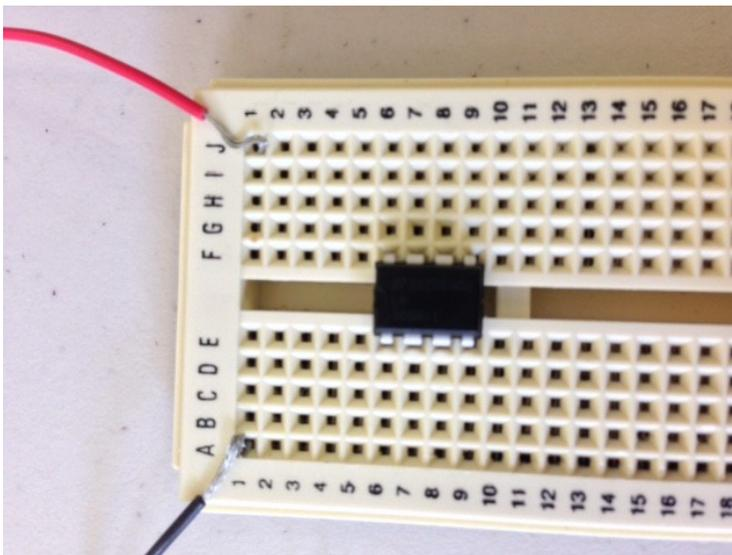

Step 3: Plug the 10 kohm potentiometer into your breadboard. The different pins on the potentiometer go in different rows. This is best done at the opposite end of the breadboard from your power rails as the potentiometer takes up much space. The potentiometer needs to be placed in this position for it to fit into the 3D printed case.

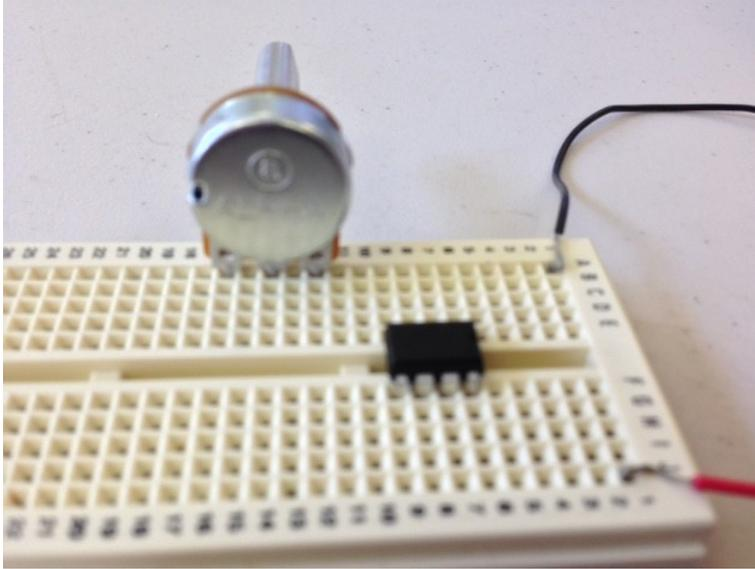

Step 4: Make more negative rails. These additional rails are needed to accommodate the large number of components which need to go to the ground rail and there are not enough tie points in a single row to accommodate this. This can be done by connecting more rows to the grounding row. These extras ground rows can be placed anywhere and moved anywhere as long as they don't interfere with other components. Some of the following pictures have one of the wires moved to a different row to show the use of this.

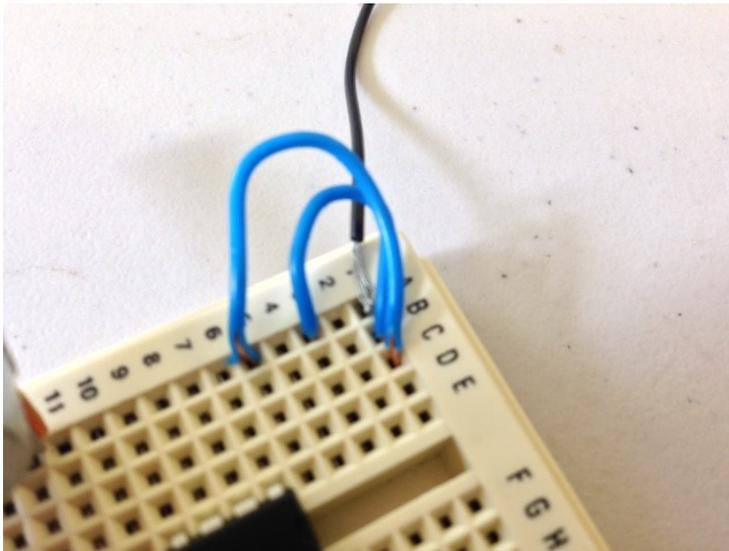

Any step after this can be done in any order. Specific rows and columns are not used because there are many right ways of doing this using the many rows and columns.

Step 5: Connect pin 2 on the op amp to ground. Remember, you now have several rows you can connect this to.



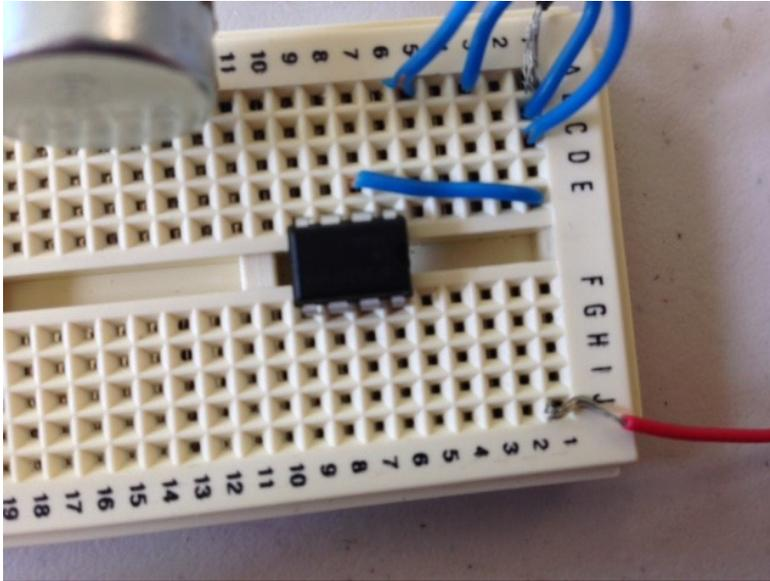

Step 6: Connect pin 6 on the op amp to the positive power supply. This is pictured in the following step.

Step 7: Connect the positive and ground rails using a 100  $\mu\text{F}$  capacitor.

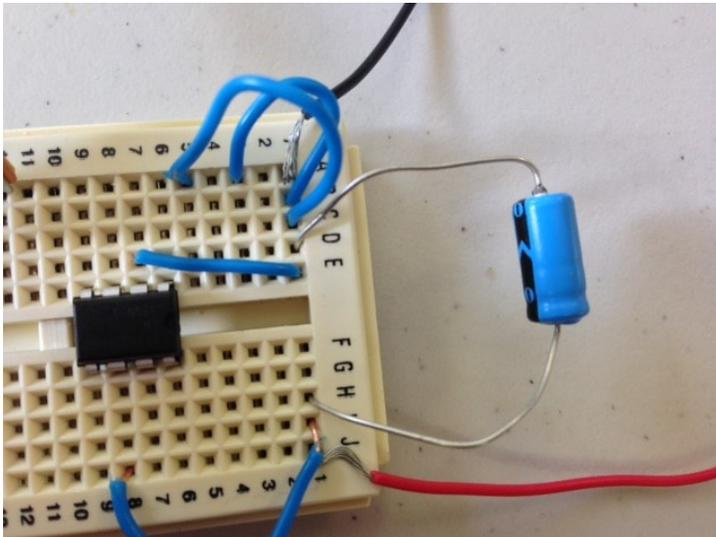

Note: This capacitor is polarized so ensure that the capacitor is plugged in properly. Refer to the circuit diagram if needed. It is also okay to bend it out of the way to make room for other components. On a polarized capacitor, the longer of the two leads is the positive end of the capacitor.

Step 8: Plug in the 47 nF capacitor (marked with “473M” meaning 47 times  $10^3$  picofarads or 47 nanofarads) and 10 ohm resistor (brown, black, black, gold, tolerance band) in series from pin 5 on the op amp to ground. Because these two components are in series, the capacitor will need to go to an empty row and the resistor will be plugged into that row going to a ground row. Neither the capacitor nor the resistor are polarized, so direction doesn’t matter.

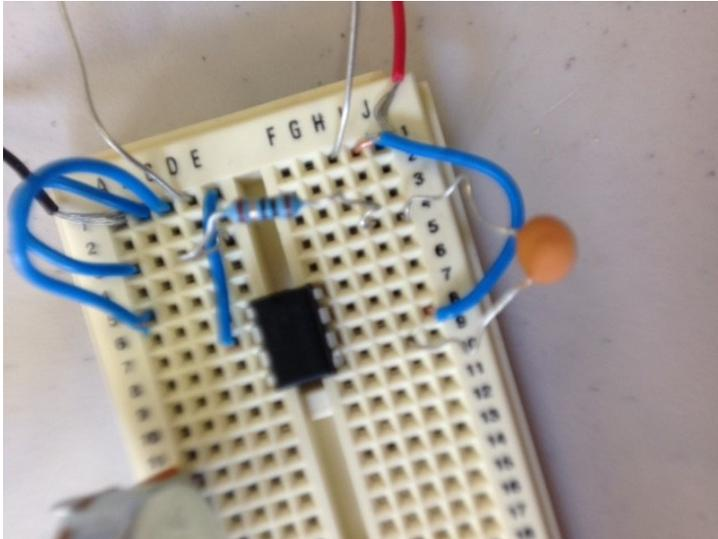

Step 9: Plug pin 4 on the op amp into a ground rail. This is picoted in the following step.

Step 10: Plug pin 7 on the op amp into a ground rail using a 100 nF capacitor (marked “104M” meaning 10 times  $10^4$  picofarads). This capacitor is not polarized so its direction doesn't matter.

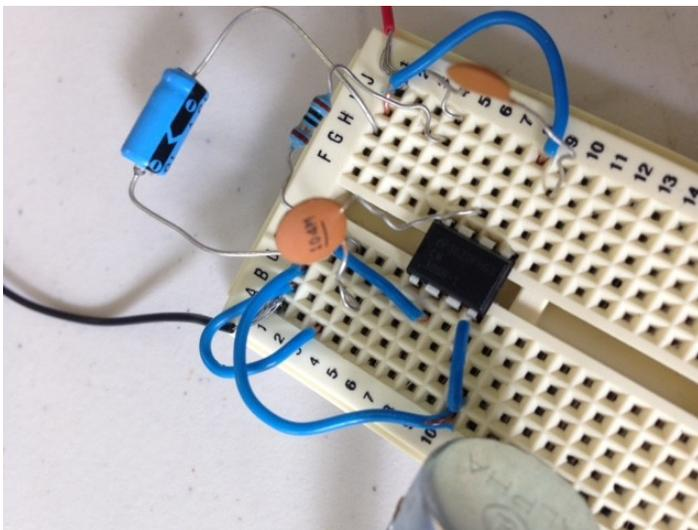

Step 11: Plug a 47 nF capacitor (marked with “473M” meaning 47 times  $10^3$  picofarads or 47 nanofarads) into pin 3 on the op amp and to the input pin (pin 2) on the 10 kohm potentiometer. If the adjustment knob is facing away from you, pin 1 is on the right side of the potentiometer, pin 3 is on the left side of the potentiometer.

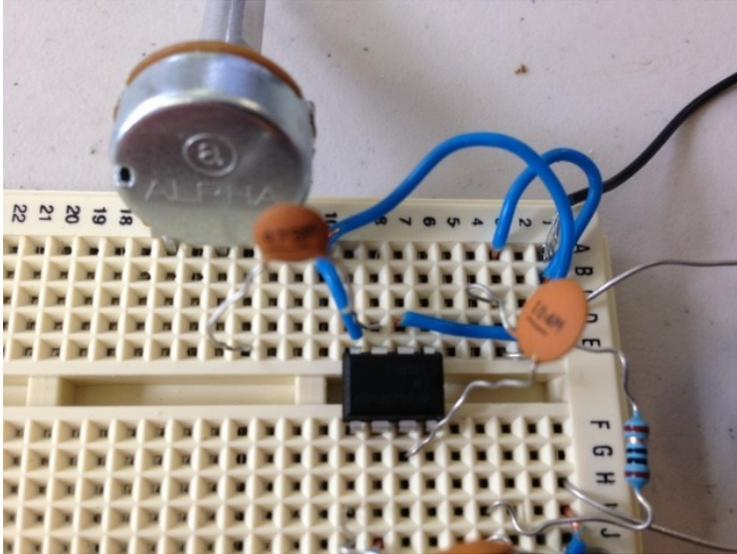

Step 12: Plug the ground pin (pin 1) on the 10 kohm potentiometer into a ground rail.

Step 13: Connect the output pin (pin 3) on the potentiometer to the audio input (3.5mm audio jack). Although this picture shows the use of alligator clips, instructors will need to solder wire to the leads of the audio jacks prior to the Bootcamp.

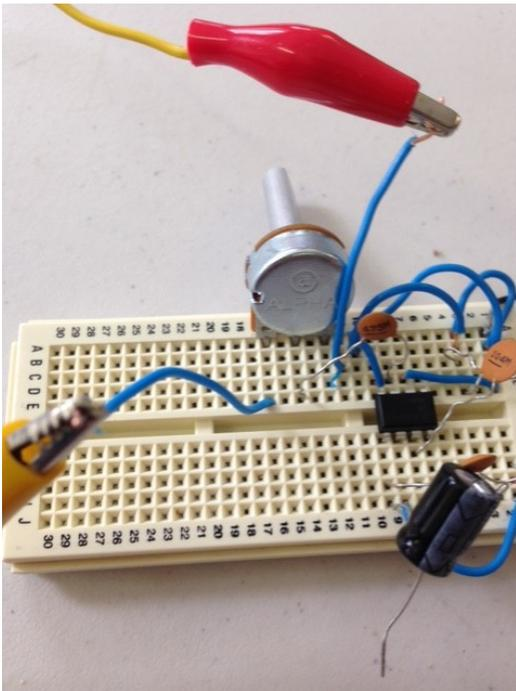

Step 14: Connect the ground lead of the 3.5mm audio jack to a ground rail.

Step 15: Connect the speaker to pin 5 on the breadboard using a 220 uF capacitor. The capacitor, which is polarized, will need to go on an empty row so that one of the leads from the speaker can be plugged into that row. The example pictured uses alligator clips from the negative pole of the capacitor to the leads on the speaker. Instructors will solder wire to the leads of the speaker prior to the Bootcamp.

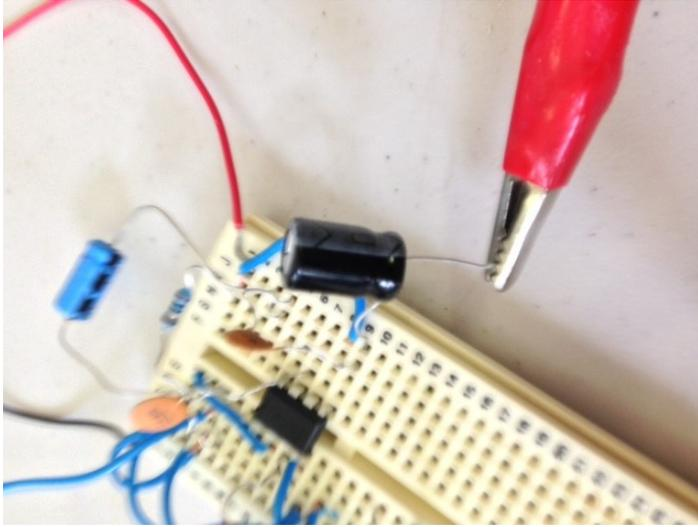

Step 16: Connect the other lead on the speaker to a ground rail.

The circuit is ready to be checked by an instructor

# Appendix U: Amplifier Student Activity Sheet

**Objective:** Construct the circuit shown using the materials provided.

**Materials:**

- 9 V battery



- 10 k $\Omega$  potentiometer



- LM386 Operational Amplifier



- Speaker

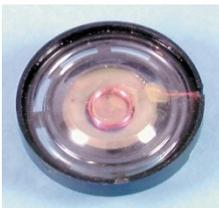

- 47 nF capacitor x2 (marked with “473” or “473M”)

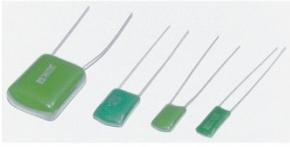

or

- 100 nF capacitor (marked with “104” or “104M”)

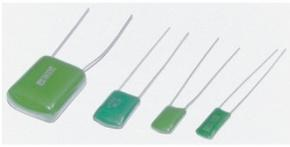

or

- 220 uF capacitor



- 100 uF capacitor



- 10  $\Omega$  resistor

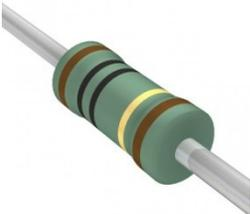

- Jumper Wires



- Breadboard



- Battery Plug



- 3.5mm audio jack



**Note:** Make sure you label where each connection is using its row and column. Ask an instructor for help if you are having trouble.

This picture indicates the recommended starting points of the three most important components, the power supply, the op amp, and the potentiometer. The power supply should be plugged into the top row of the breadboard. The op amp should be plugged across the gap into rows 5-8. The potentiometer should be plugged into the bottom row of the breadboard, putting the ground pin in row 13, the output pin in row 15, and the input pin in row 17. Although this is a recommended setup, you do not need to follow this.

However, the potentiometer needs to be in its current position in order to fit the breadboard with the components into your case.

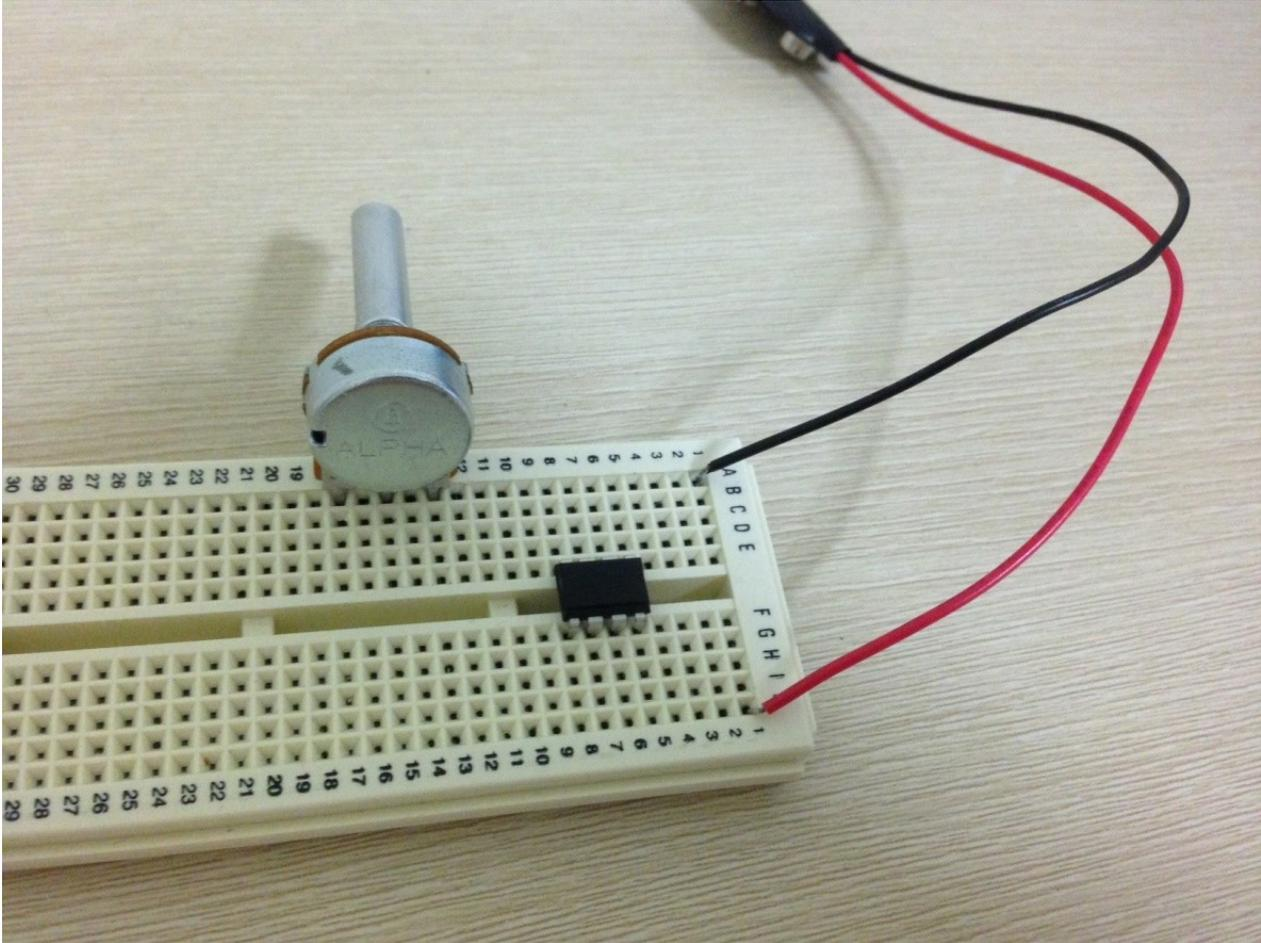

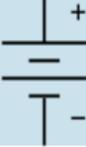
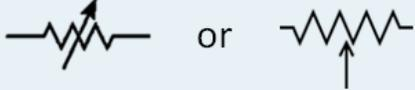
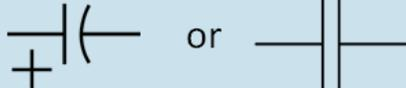
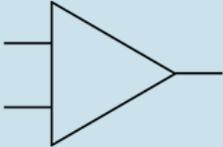

Component	Symbol
Battery	
Wire	
Resistor	
Potentiometer	
Capacitor	
Speaker	
Op-Amp	

# Resistor Color Code

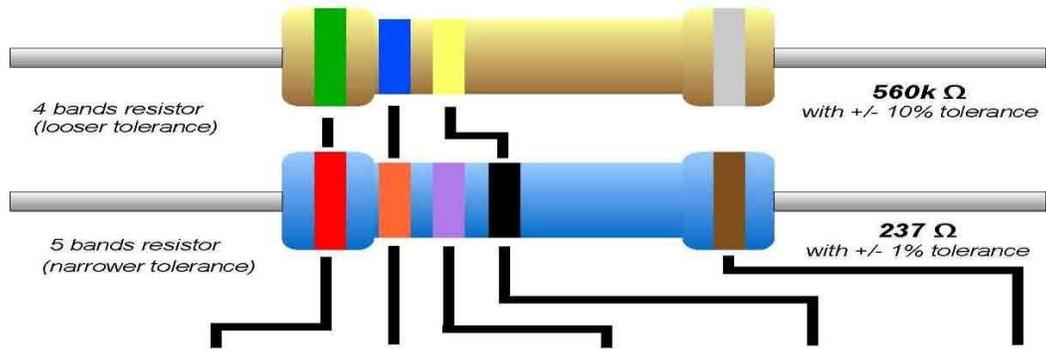

Color	1 <sup>st</sup> Band	2 <sup>nd</sup> Band	3 <sup>rd</sup> Band	Multiplier	Tolerance
Black	0	0	0	x 1 $\Omega$	
Brown	1	1	1	x 10 $\Omega$	+/- 1%
Red	2	2	2	x 100 $\Omega$	+/- 2%
Orange	3	3	3	x 1K $\Omega$	
Yellow	4	4	4	x 10K $\Omega$	
Green	5	5	5	x 100K $\Omega$	+/- 5%
Blue	6	6	6	x 1M $\Omega$	+/- .25%
Violet	7	7	7	x 10M $\Omega$	+/- .1%
Grey	8	8	8		+/- .05%
White	9	9	9		
Gold				x .1 $\Omega$	+/- 5%
Silver				x .01 $\Omega$	+/- 10%

## 9v Audio Amplifier Circuit

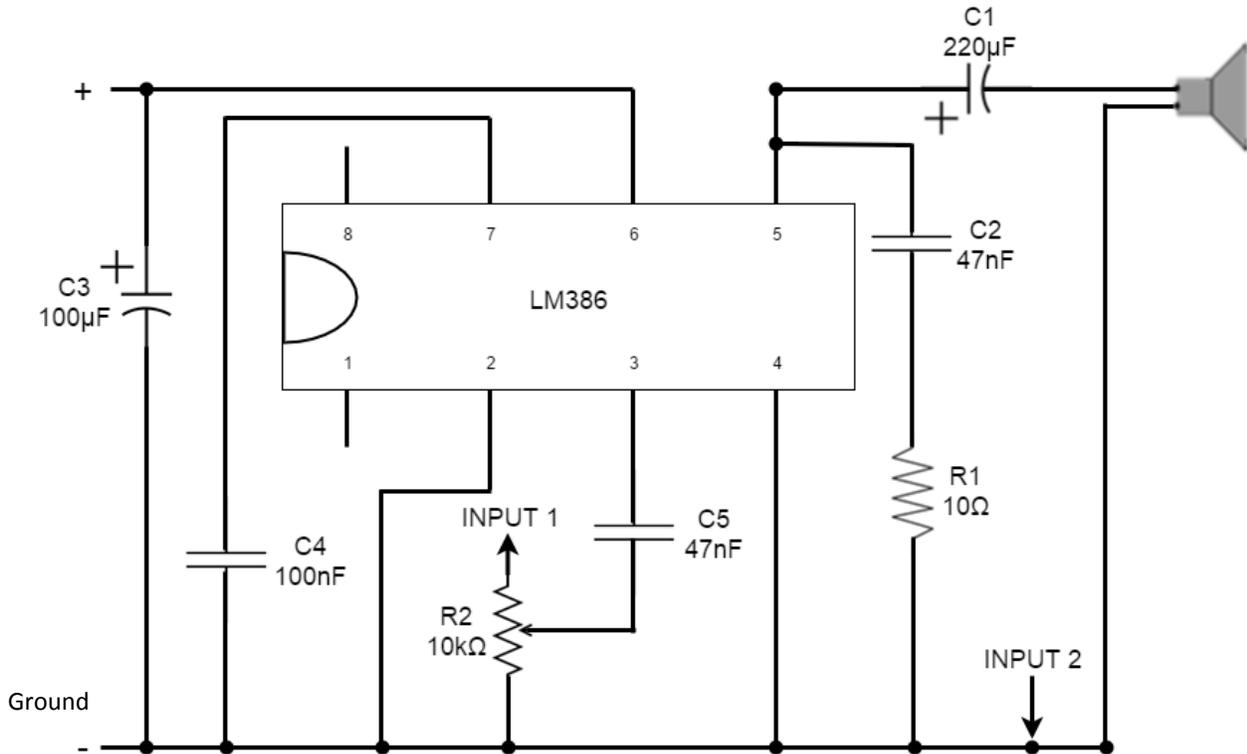

NOTE1: - is the negative pole of the battery (black), + is the positive pole of the battery (red)

NOTE2: Input1 and Input2 are the two wires connected to the audio jack. The audio jack goes into your phone or computer (i.e. into a sound source).

NOTE3: All pins that are connected to ground (where ground is the negative pole of the battery) *don't have* to be connected on a single rail. By connecting the negative pole to a rail and having a wire connecting that rail with another one, any component connected to the second rail is ALSO connected to the negative pole.

NOTE4: Polarized capacitors should have their longer lead at the position of the plus sign next to them (see 100μF and 220μF capacitors C1 & C3).



# Appendix V: Notes on Background Theory

Basics of Electricity: Slide on electricity inspired by <https://learn.sparkfun.com/tutorials/what-is-electricity>

The site also contains an explanation of how a battery powered circuit works.

## Different Appliances:

Difference between all presented appliances is their energy source. Desktop computers solely use wall sockets to get power. Laptops use both wall sockets to get consistent power and also store part of this energy in their battery for later use. Phones connect to wall sockets in order to charge their battery. Wireless mice and tv controllers use batteries as their energy source.

## Different Electricity Sources:

Main Electricity: The power stations that generate electricity are usually located near energy sources, such as coal mines, natural gas production plants, or hydro-electric plants. But the electricity needs to be delivered to where most of its end users are located, which tends to be in cities and major towns.

Transmission networks move the electricity from the power stations to the distribution networks. The electricity is transmitted at high voltages so that large amounts can travel efficiently over long distances.

When the electricity reaches the distribution networks, it passes through substations, which use transformers to lower the voltage of the electricity ready to deliver for everyday use.

Distribution power lines carry electricity to its final destination, such as your home or business. Power lines are often visible along the sides of roads, and sometimes they're underground.

## The role of transmission and distribution networks

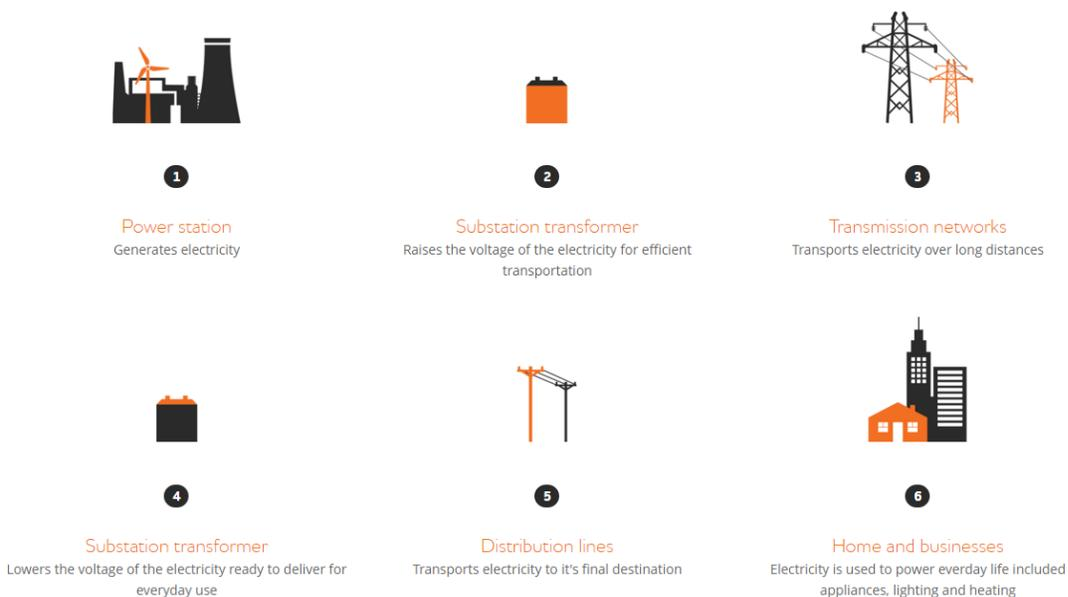

Read more about power stations at: <http://www.explainthatstuff.com/powerplants.html>

### Electric Cells & Batteries:

Electrical Cell is a power generating device which converts the stored chemical energy into electrical energy. It is the combination of electrodes and electrolytes, where a difference of certain electric potential is established between the electrodes as a result of the chemical reaction between the electrodes and electrolytes.

The difference in the electric potential between electrodes in an electrical cell depends upon the types of electrolytes and electrodes used.

A single unit of electro-chemical generator is known as Electrical Cell, while the combination of several such units connected electrically is known as a Battery. Several cells are combined and connected electrically in series or parallel to form a battery which have two main terminal electrodes one Positive and one Negative. The electrical potential difference between the two main electrodes depends upon the numbers of cells, types of cells and the types of combination used to form the battery.

Read more about electric cells & batteries at <https://electronicspani.com/electrical-cells-and-battery/>

### Key Terms:

An **electrical current** inside a circuit is created by a stream of **moving electrons**. Electrons can travel through some materials but not others. Materials through which electrons travel are called **conductors**. Materials through which electrons travel poorly or not at all are called **insulators**.

Some examples of conductors are silver, gold and iron.

Some examples of insulators are glass, plastic and wood.

A **wire** is simply a good conductor on the inside and a bad conductor/insulator on the outside. This permits electricity/electrons to travel in the inside easily, but restricts energy losses to the environment and also people getting electrocuted when they touch the wire.

**Current (I)** is the **quantity of electrons** passing a given point. The unit of current is the Ampere (A). One ampere is equivalent to 6,280,000,000,000,000 or  $6.28 \times 10^{18}$  electrons passing a point during a one second time interval.

**Voltage (V)** is the **electrical pressure** or force. Voltage is also sometimes referred to as potential. Voltage drop is the difference in voltage between two ends of a conductor through which current is flowing. The unit of voltage is Volts (V).

**Power (P)** is the **work performed** by an electrical current. The unit of power is the Watt (W). The power of a direct current is equivalent to its voltage times its current.

**Resistance (R)** measures how a device or material of a circuit **reduces the electric current** flowing through it. The unit of resistance is the Ohm ( $\Omega$ ). The resistance of a conductor is its voltage drop divided by the current flowing through the conductor.

By using **Ohm's Law** and given two of the above, you can find the any of the other two using the following formulas:

$$V = I \times R$$

$$I = V / R$$

$$R = V / I$$

$$P = V \times I = I^2 \times R$$

Water Analogy:

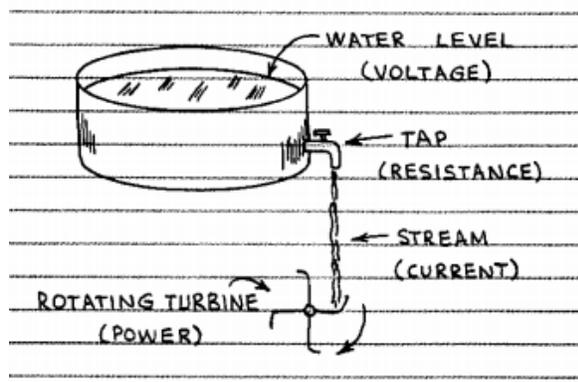

Using the water analogy helps to visualise the key concepts. The voltage refers to pressure, which is equivalent to the water level. More water would result in more pressure against the walls of the container. The resistance is the force reducing the current and thus is equivalent to the tap. The current is the number of electrons passing a given point, so in our case the number of water molecules that make up the stream of water flowing out. The power is the work performed by the circuit, in our case the resulting work is rotating the turbine in order to generate energy.

More on Basic Concepts and the Water Analogy: <https://learn.sparkfun.com/tutorials/voltage-current-resistance-and-ohms-law/all>

Knowing these key concepts allows us to move on their practical application, creating an electrical circuit. An **electrical circuit** is any arrangement that permits an electrical current to flow.

Engineers don't use circuits illustrated in pictorial form, but instead use **circuit diagrams**. A circuit diagram is what you will be given today, in order to create your own phone speaker. We need to make sure, thus, that we can understand all components that might appear in a circuit diagram and how to connect them.

**Battery:** The battery's negative pole reacts with electrons' negative charge and pushes them away. In a similar fashion, the positive pole of the battery attracts electrons. The cycle repeats and a flow of electrons is established (electric current as mentioned before).

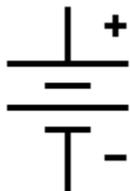

**Resistor:** Resistors limit current. A resistor has a certain resistance measured in Ohms, which reduces the electric current passing between the two connecting points.



**Resistor Color Code:** is used to measure the value of a resistor. There is a different color code for 4-bands and 5-bands resistors.

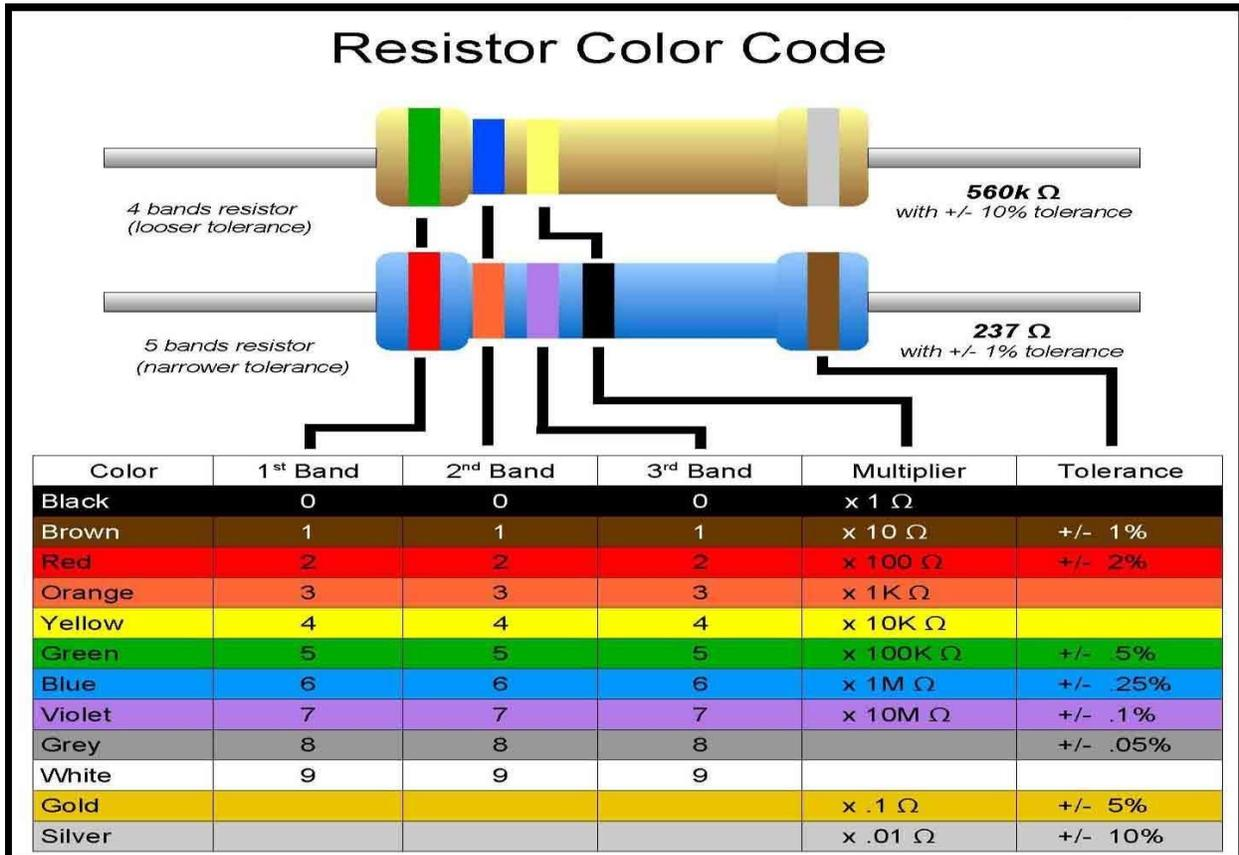

For example a 4-band Yellow, Red, Green would be equivalent to  $42 * 100 = 4,200 \text{ k}\Omega$ . And then the last band would give the tolerance.

To distinguish left from right there is a gap between the C and D bands. So, the three or four closest to each other are the left side of the resistor. Another way to distinguish the left from right side, is the fact that gold and silver are ONLY used as tolerance indicators for 4-band and multiplier/tolerance for 5-band. Thus, if there is a gold/silver (and most likely there will be) band, this is the right side of the resistor.

More on using the color code to read resistances here:

<http://www.circuitstoday.com/resistor-color-code-chart>

Or here:

<http://www.dummies.com/how-to/content/electronics-components-how-to-interpret-resistor-c.html>

**Resistor Substituting:** Note that if we are missing a specific resistor value (for instance 1500 Ohm) we can connect other resistors in appropriate combination (for instance 1000 and 500 in series, or 3000 and 3000 in parallel) in order to get the needed value. The resulting values when connecting resistors in series or in parallel are given in the picture below:



In Series

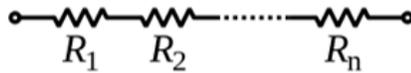

$$R_{\text{total}} = R_1 + R_2 + \cdots + R_n$$

In Parallel

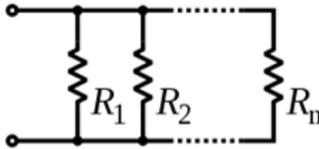

$$\frac{1}{R_{\text{total}}} = \frac{1}{R_1} + \frac{1}{R_2} + \cdots + \frac{1}{R_n}$$

Practice problems found at:

<http://www.facstaff.bucknell.edu/mastascu/elessonshtml/Resist/Resist2.html>

**Variable Resistor:** One of the resistors that we will be using today is the variable resistor. Variable resistors are also called **potentiometers**. Variable resistors are used when it's necessary to change the resistance of the resistor in use. For example, changing the volume of a radio, or the brightness of a lamp can be done by using a potentiometer.



**Capacitor:** A capacitor stores electrons while charging and then when full, gradually discharges freeing the electrons.

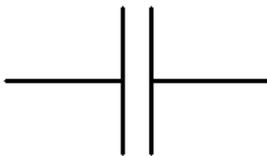

**Amplifier:** An Amplifier does exactly what its name suggests, amplifies some quantity. In our case, we will be using an **Operational Amplifier**, or as usually referred to **Op-Amp**.

**Op-Amp:** Op-amps amplify the difference between voltages or signals applied to their two inputs. For example an Op-amp with gain 100, under ideal conditions, would output 100V if provided with inputs equivalent to  $V_1=1$  and  $V_2=2$ .

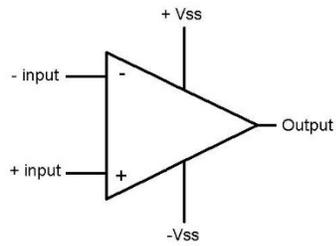

More on Op-Amps: <http://electronicdesign.com/analog/how-do-operational-amplifiers-operate>

**Speaker:** Converts variations in a current or voltage into sound waves. We will be using one of the most common type of speakers, the magnetic speaker.

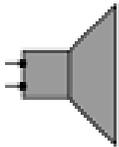

More on basic components of circuitry: <http://engineering.nyu.edu/gk12/amps-cbri/pdf/Intro%20to%20Electricity.pdf>

How to connect stuff to breadboard: <http://www.allaboutcircuits.com/textbook/direct-current/chpt-5/building-simple-resistor-circuits/>

# Appendix W: Audio Amplifier Activity Template

[www.csmo.au](http://www.csmo.au)

**CEdO  
Science**

## **Bootcamp**

Audio Amplifier

January 2016

# Contents

1	Two day overview	3
2	Hands-On Activity Program Overview	7
3	Activity Timeline	9
3.1	Day 1. 90 minutes	9
3.2	Day 2. 110 minutes	10
4	Risk Assessment	11
5	Presenter notes/Activity details	14
5.1	Activity 1: Introduction to Sound and Waves and Make a Xylophone Activity	14
5.2	Activity 2: Circuit Assembly Activity	17
5.3	Activity 3: 3-D Printed Name Plate	25
5.4	More detailed background information with references	26
5.5	CSIRO Stories	28
6	Equipment List	32

# 1 Two day overview

## Day 1

Time	Activity/Event	Venue	Notes	Presenter roles	Example
9:00am – 9:45am	Setup for the day			Presenters 1, 2, 3 setup	GK Williams Room
					GK Williams Room
9:45am – 10:05am	Doors open Student arrival		Students arrive Need something to entertain those on time or a space for them to congregate in. Science Hangman works surprisingly well.	Presenter 2 sign-in sheet	
				Presenters 1, 3 in room with students	
10:05am – 10:15am	<u>Behavioural</u> expectations and safety announcement (toilets etc) Get to know you questions		See Educate file path: Public/Community Engagement/BC/BC admin and planning/BC icebreaker activities.pptx	Presenter 2 sign-in sheet	
				Presenters 1, 3 in room with students	
10:25am – 11:00am	Presentation – CSIRO researcher		20min talk, 15min Q&A	Presenters 1,2 supervising Presenter 3 on break 10:45-11:25	
		Outdoors if	Need time to move to first lab tour		

<b>11:00am – 11:20am</b>	Morning tea	weather permitting	Presenter 1, 2 supervising Presenter 3 on break 10:45-11:25	
<b>11:30am – 1:00pm</b>	Lab tours	Either 2x lab tours with 15 students per lab (rotate) approx. 40min per lab (with walking time) OR 2x lab tours with 10 students per lab plus non-lab break with airplane design from 'Thinking Scientifically' or equivalent activity.	All 3 presenters required	GK Williams Room
<b>1:00pm – 1:45pm</b>	Lunch	Students provide their own lunch	Presenter 1 on break (1:10 – 1:50pm) Presenter 2 on break (1:50 – 2:30)	Outdoors if weather permitting
<b>1:45pm – 3:15pm</b>	Sound background and xylophone activity	See detailed activity breakdown for details.	Presenter 2 and 3 supervising  Presenter 1 setting up open ended activity (2:00pm – 2:15pm)	GK Williams Room/outdoors weather permitting
<b>3:15pm – 3:30 pm</b>	Wrap up, clean up.	Reminders for tomorrow	Presenter 1 sign-out sheet Presenter 2, 3 supervising	GK Williams Room

3:30pm – 4:30pm

Presenters clean up and re-set for day 2.

Presenters 1, 2, 3 pack up

## Day 2



Time	Activity/Event	Venue	Notes	Presenter roles	Example
9:00am – 9:45am	Setup for the day			Presenters 1, 2, 3 setup	GK Williams Room
9:45am – 10:05am	Doors open Student arrival		Students arrive Need something to entertain those on time or a space for them to congregate in. Science Hangman works surprisingly well.	Presenter 2 sign-in sheet  Presenters 1, 3 in room with students	GK Williams Room
10:10am – 11:30am	Self-contained laboratory experience		Special notes exist for BC students. Remember you may need extra explanations at the start based on age of students.	Presenter 2 sign-in sheet  Presenters 1, 3 in room with students	
11:30am – 12:00pm	Morning tea	Outdoors if weather permitting	Students provide their own recess		
12:00pm – 12:40am	Presentation – CSIRO researcher		20min talk, 15min Q&A	Presenters 1,2 supervising Presenter 3 on break (12:00–12:40)	

<b>12:40am – 1:15pm</b>	CSIRO Quiz		Available in Bootcamp folder. Includes a physical challenge so have required lab supplies ready	Presenter 1 on break (12:40–1:20pm)
<b>1:15pm – 2:00pm</b>	Lunch	Outdoors if weather permitting	Students provide their own lunch	Presenter 2, 3 supervising
<b>2:00pm – 3:50pm</b>	Amplifier assembly and nameplate design		See below for activities in detail with timeline	Outdoors if weather permitting
<b>3:50pm – 4:00pm</b>	Wrap up, clean up.		Thanks <del>you</del> to presenters and students, evaluation forms filled in, items all collected.	Presenter 1 sign-out sheet Presenter 2, 3 supervising
<b>4:00pm – 5:00pm</b>	Presenters clean up			Presenters 1, 2, 3 pack up

□



## 2 Hands-On Activity Program Overview

**Program name:** Making Waves!

**Developed by:** Adam Gatehouse and Georgios Karapanagos

**Date of bootcamp/s:** January 2016

**Brief program outline** (max. 2-3 sentences):

Students explore circuit design, the use of electronic components in integrated circuits, discover practical and novel uses for this technology, and the versatility of integrated circuits. Students will also learn about waves in several forms, such as sound waves, and their interactions materials.

### Key concepts/points the program covers

#### Waves

- How sound is made
- Sound wave activities
- Build xylophone and record data as a team

#### Electricity Overview

- Different sources of electricity
- Basic concepts of electricity
- Ohm's Law
- Making simple circuits

#### Electronic Components

- What different electronic components are and their uses
  - Resistors
    - Resistor Color Code

- Resistor Substitution

- Capacitors
- Operational Amplifiers
- Breadboards

Circuit design and circuit diagrams

- Different symbols in circuit diagrams
- Integrated circuits

### 3 Activity Timeline

Day 1. 90 min

Time (min)	Event	Notes
0 – 20	Sound and Waves Overview	<ul style="list-style-type: none"><li>● Give students an overview of sound and waves. Include demonstrations such as demonstrating wavelength and frequency by moving a slinky up and down.</li></ul>
20-50	Make Your Own Xylophone	<ul style="list-style-type: none"><li>● Students work in teams of 3 to create a xylophone by filling glass bottles with water. Students will be determining how high the water needs to be to create musical notes. As students do this, they will be recording frequency and water level and graphing these to find a relation between the two.</li></ul>
50-75	Intro to Electricity	<ul style="list-style-type: none"><li>● Display normal circuit for speaker</li><li>● Overview of electricity and discussion of the different sources</li><li>● Discuss the use of electrical components (resistors, capacitors, operational amplifiers)</li><li>● Graphite drawn circuit (individual activity)</li><li>● Students learn to identify different resistors</li></ul>
75-90	Resistor Matching Game	<ul style="list-style-type: none"><li>● This activity is completed as a team</li><li>● Students are given a desired resistor and students work together to create the proper color code for that resistor</li></ul>

Day 2. 110 minutes

Time (min)	Event	Notes
0 – 10	Review of Material	<ul style="list-style-type: none"><li>● Briefly review the material which students will need to know to assemble their circuit (material on electronics from Day 1)</li></ul>

from Day 1		
<b>10-30</b>	Breadboard Practice	<ul style="list-style-type: none"> <li>● Students learn to assemble circuits and to use their breadboard by assembling circuits on their breadboard</li> <li>● Students will measure the voltage drop across these components</li> </ul>
<b>30-90</b>	Amplifier Assembly	<ul style="list-style-type: none"> <li>● Students will start assembling their amplifier circuits with any needed help from the instructors</li> </ul>
<b>90-110</b>	TinkerCAD designed nameplate	<ul style="list-style-type: none"> <li>● Students will use TinkerCAD to design a nameplate which will be 3-D printed and mailed to them</li> <li>● Students will go up to use TinkerCAD as they complete their amplifier circuits</li> </ul>

## 4 Risk Assessment

		High	Medium	Low			
		High	Medium	Low	High	Medium	Low
Burns from extruder and print bed on 3D printer and soldering iron	The extruder in the 3D printer is heated to 200°C and the bed is heated to 100C and the soldering iron is heated to 315 C		X		<ul style="list-style-type: none"> <li>The printer is enclosed so students cannot touch</li> <li>Students are supervised and only allowed to observe the printer working</li> <li>The presenters are the only ones to use the printer and they are instructed on how to use it safely</li> <li>Printer automatically cools the extruder and bed to room temp when not in use (only takes 3-5mins)</li> <li>If instructors do the soldering, there is minimal risk to students</li> <li>Ensure instructors are trained in the use of soldering irons</li> <li>Ensure all soldering irons work before the activity starts</li> <li>If the students do the soldering, show them how to use a soldering on before they use it and have an instructor supervise their use of soldering irons</li> </ul>		X

Electrocution	Some equipment (eg 3D printer, computers if plugged into power) powered from a mains power supply, or a circuit powered by a 9V battery.	X	<ul style="list-style-type: none"> <li>• All electrical equipment to be electrically tested annually</li> <li>• Access to power point is as restricted as possible within the limits of the specific room.</li> <li>• Battery being used in circuit is too low power to harm students</li> <li>• Although electronics are sensitive to water, no students will be electrocuted if the circuit falls into water, it's too low power</li> </ul>	X
Cuts	Fingers might get cut when cutting wires or trying to plug them into the breadboard. Broken glass due to broken bottles if a student drops a bottle or hits it too hard	X	<ul style="list-style-type: none"> <li>• Using pre-cut wires removes the need for cutting wires</li> <li>• Instructors should supervise students, making sure that they are not being reckless with their wires or other equipment</li> <li>• Demonstrate to the students how hard to hit the bottles so as not to damage them</li> <li>• Have necessary cleanup equipment on hand to clean up broken glass</li> <li>• Bottles are only to be hit with the spoons provided</li> <li>• Bottles are only to be used while placed on a workbench and they should not be held by students while tapping them</li> </ul>	X
Eye Injury	Students may poke themselves or other students in the eyes with wire ends	X	<ul style="list-style-type: none"> <li>• Have students wear safety glasses</li> <li>• Instructors should supervise students, making sure that they are not being reckless with their wires or other equipment</li> </ul>	X
Component Failure	If plugged in incorrectly, some electronic	X	<ul style="list-style-type: none"> <li>• Presenters do not hand out batteries until they have checked a student's circuit</li> <li>• Have an instructor check the circuit before</li> </ul>	X

components (capacitors in particular) may overheat and pop

students plug in their batteries (instructors will have detailed instructions on what should be plugged where)

- Students can wear safety glasses while assembling their circuits
- Warn students of the dangers of electronic components and not to short circuit components

Ear Damage	Sound levels from modified speakers causing temporary or permanent damage to a student's hearing	X	<ul style="list-style-type: none"><li>• Warn students against the damaging effects of prolonged loud noises to their hearing</li><li>• Prolonged exposure to loud noises can cause temporary or permanent hearing damage</li><li>• Students are unlikely to expose themselves to loud noises due to pain</li></ul>	X
------------	--	---	--	---

## 5 Presenter notes/Activity details

### 5.1 Activity 1: Introduction to Sound and Waves and Make a Water Xylophone

#### Outline

- Introduction to speakers and sounds
  - Go over background information in [Powerpoint](#), introducing things like wavelength and frequency
  - Use a slinky to demonstrate transverse and longitudinal waves. Up and downward movements with slinky are transverse waves. Transverse waves, the particles vibrate at a right angle to the direction of the wave. A longitudinal wave is created with a push of the slinky while it is resting on a surface. The vibrations here are parallel to the direction of the waves. The faster you pump the slinky (so the higher the frequency), the shorter the wavelength is.
- Make a Water Xylophone
  - Students will be put into groups of 3.
    - The activity is to properly fill several bottles with a proper amount of water to generate several musical tones.
    - Students will record their results for frequency (measured by instructors with the app “Feedback Detector”) and water level to graph them. Once the students have collected enough data points, they will see the relationship between the water level and frequency generated.
    - Assign each team 5 different frequencies, and give them time to fill their bottles accordingly.
    - The team with the overall closest frequencies to the assigned goals will win the challenge.
  - The next step is to give the students the frequencies for musical notes (in [Powerpoint](#)).
    - The students can then try playing simple songs with each other after finishing.
- There are also really cool videos online
  - Go to [youtube](#) and search [Cymatics](#). It’s the clip by Nigel Stanford (optional)
  - Best shown at the end of Bootcamp for ideas of more experiments they can look into and explore on their own (optional)
- Materials needed:
  - Water



- o Large Beakers x 10
- o Glass bottles x50
- o Spoons (metal) x20
- o Sheets of paper x10 (one for each team)
- o Pencils x10 (one for each team)
- o Metal Slinky x3

### Process

- Do a demonstration of the xylophone activity.
- Quickly review the agenda for the day, so the students are aware of the schedule.
- For more information on any of the topics to discuss, please refer to the background packet.

### Sound

- Discuss the connections to CSIRO provided on the slides. Be sure to emphasize their connection to sound and waves.
- Ask what sound is, and then give them the definitions on the slide after they have given their answers. Talk about sound being a wave.
- Added blank slide with “how are sounds made” Ask the students how sounds are made. Discuss that sound is the result of vibrations in a medium.
- Ask if someone knows what a continuous sound comes from. Answer: objects vibrating back and forth like drumming. Pass around tuning forks and show the students the vibrations causing sound. Maybe find a new video here? Don’t need it though

### Waves

- Ask students what a wave is and what defines a wave.
- Ask the students what the different types of waves are. Then describe both longitudinal and transverse waves. Use a slinky to demonstrate transverse and longitudinal waves. Up and downward movements with slinky are transverse waves. Transverse waves, the particles vibrate at a right angle to the direction of the wave. A longitudinal wave is created with a push of the slinky while it is resting on a surface. The vibrations here are parallel to the direction of the waves. The faster you pump the slinky (so the higher the frequency), the shorter the wavelength is.
- Then go over frequency, amplitude and wavelength.
- Do a quick activity with a dog whistle app. The app “Dog Whistler - Your Free Dog Whistle” should be downloaded on the presenter’s phone. After explaining that the human range of hearing is between 20 Hz and 20,000 Hz, test the hearing range of the students. Begin at 20 Hz and slowly move to 20,000Hz. Have the student raise their hand when they can start to hear sound and then put down their hand when they cannot hear the tone any longer. See which students have the best hearing.
- Briefly go over sounds through different mediums, sound travels fastest through solids since the molecules are most tightly packed together, then liquids, then gases.

### Xylophone Activity

- This activity will use the application 'Spectrum Analyser' by keuwisoft on Android, and 'Feedback Detector' by Sonoma wireless on IOS.
- When testing frequencies, hit the bottles in the same spot a few times in a row to try and see where the frequency on the application is bouncing around.
- Explain the xylophone competition and break the students into different teams than before.
- Explain that the students need to construct a graph to show the correlation between water level and frequency produced. (use paper and give them rules to draw straight lines and plot proper points)
- Once they have created a complete graph, assign them 5 random frequencies they must attempt to make and have each group be assigned different frequencies. Make sure the assigned frequencies are within the following range (1600 to 2800 Hz)(Range may be different with different bottles). Hold a competition to see who can match their frequencies most accurately.
- Tell the students that each musical note corresponds to a certain frequency. Have them choose a simple tune they can look up and learn how to play. They will create the appropriately needed notes with their bottles so that they can play the simple song they selected. Have every group attempt to play their music for the rest of the students after practicing with their new instrument.

### CSIRO Connections

- Anechoic Chamber
  - Successful calibration of noise measuring equipment to international standards requires an anechoic chamber
  - An anechoic chamber prevents the reflection of sound waves by completely absorbing them
  - Prolonged solitude in an anechoic chamber can cause disorientation in humans because it is so quiet
- Research Vessel Investigator
  - This is a new vessel supporting Australia's atmospheric, oceanographic, biological, and geosciences research
  - The Investigator maps the ocean floor using sonar waves
  - Analyses weather patterns with a meteorological radar system
  - The Investigator is tasked with deep sea oceanography, mapping and studying the geology of Australia's marine estate, and to learn more about Australia's weather patterns and large ocean processes
- Wildlife Sound Archive
  - CSIRO's wildlife sound archive is part of the Australian National Wildlife Collection (ANWC)
  - Library consists of over 60000 recordings, making it one of the largest libraries of its kind in the world
  - This library is currently being turned into a digital database
  - The database is steadily being made available online through the Atlas of Living Australia

## 5.2 Activity 2: Electronics, circuitry, and circuit assembly

### Outline

- Introduce basic concepts of electricity
  - Ohm's Law
  - Circuit drawn on paper (activity)
- Introduce students to electronic components
  - Discuss with students different electrical components
  - Resistor Color Code (activity) and resistor substitution (work with the presenter)
  - Have students do small exercises/demos with circuits before assembling their speakers
- Students work as individuals to assemble their circuits
  - Students can choose to assist each other if they want to work together or they finish early
- Have extra components on hand so students have extras in case they mess up
  - Extra components should have been ordered
  - Encourage students to discover means of improving their circuits on their own after they leave Bootcamp
  - The first one should be taking the 100 nF capacitor from 7 on the op amp to ground out of the circuit and putting a 100 uF capacitor from pin 1 to pin 8 on the op amp. This increases the gain on the op amp, increasing the output voltage, increasing the loudness of their music. Their speakers will not be able to handle this gain though.
- Students have 60 minutes to construct their circuits
- Students are able to design different circuit configurations
- If circuit is incomplete, an instructor should help them finish if the student is running out of time
- Materials needed:
  - Breadboard x30
  - 10 kohm potentiometer x30
  - 47 nF capacitor x90 (this includes extras)
  - 100 nF capacitor x45 (this includes extras)
  - 100uF capacitor x45 (this includes extras)
  - 220 uF capacitor x45 (this includes extras)
  - 10 ohm resistor x30
  - LM386 Op Amp x30
  - 9V battery x30
  - Jumper wire kits x5 (to be shared by the students)

- Soldering Iron x1 (to be on standby if someone needs something soldered again)
- Soldering wire (to be on standby with the soldering iron)
- Speaker x 30
- 3.5mm audio jack x30
- Handouts/Instructions x30

## Process

### Demonstration

- Part begins by demonstrating the final audio amplifier circuit working.
- The presenter can then say that we need to go over some *slightly* not VERY fun stuff before we get into the fun part of our activities.

### What is Electricity?

- Go over the slide and mention that today will focus on current electricity
- Briefly explain what a circuit is

### Draw Circuit Activity

- Students get an 50mm x 50 mm piece of paper, a 9V battery, 6B graphite pencils and an LED.
- The students will connect the two poles of the battery on one side of the A4 paper with tape and then draw a thick and completely colored in short path with their graphite pencil starting from the two poles.
- Make sure the paths are NOT connected in any way.
- Connecting each lead of the LED to a different path lights up the LED.
- This teaches student how conductors work and how the battery pushes the electrons away from the negative side towards the positive side.
- A conductor that allows electrons to move freely allows a current to be established, helping students understand how batteries and wires work.
- The closer you bring the LED to the battery the stronger the light it emits
- This is because there is a smaller path travelled, so the resistance of the graphite path is less.
- This also demonstrates how resistance works and that in real life, we should expect that even wires have a slight resistance, not just resistors.

### Real Life Context

- Ask students about the daily use of electricity and to give some examples of appliances.
- After they have identified the 4 given in the slide, ask them whether they can think of any difference between them. Size/power needed/different source are acceptable answers.
- Use this to go into the two different sources of electricity.

### Different Sources of Electricity

- Present with the help of background info.

### Basic Concepts of Electricity & Ohm's Law

- Present with the help of background info.

### Intro to Circuitry

- Tell students that scientists won't get the help that CAN (not will) be provided to them today.
- They don't have a picture of the working circuit, neither descriptions nor instructions on how to connect components.
- Instead, they get a very complicated diagram like the one shown and have to understand how to read the schematic and assemble the circuit.
- That is why we need to know the basic components and how to connect them.

### Basic Components

- Present with the help of background info.

### Resistor Color Code & Resistor Substitution

- Present with the help of background info and run the examples given for students.

### Resistor Color Code Activity (if time permits)

- If time permits and if the students have understood the resistor color code concept, split them into groups of 3 or 4.
- In this activity, the presenter will say one resistor value (i.e.  $1500\Omega$ ) and a type of resistor (i.e. 5 band) and the students have to find the correct colors from left to right.
- The students can either raise their hand and answer it first, or the presenter can have the students come up to the board and write their answer. The answer on board can be drawn, shown with stickers or simply written R/Y/G based on preferences and availability of materials.
- Example of given resistor values:
  - 4 band  $250\Omega$   
○ Answer: Red/Green/Brown
  
  - 4 band  $7\text{ k}\Omega$   
○ Answer: Violet/Black/Red

- o 5 band 625  $\Omega$
- o Answer: Blue/Red/Green/Black
  
- o 5 band 520 k $\Omega$
- o Answer: Green/Red/Black/Orange

#### Series & Parallel, Breadboard

- Explain that in slide 68 the electrons leave the negative pole of the battery, travel through the 3 resistors and then back to the positive pole of the battery.
  - o This means that there is only 1 path, so all components are connected in series.
- Explain that in slide 68 there are two paths between the resistors so they are connected in parallel.
  - o This will help them understand the difference between in series and in parallel.
- The answers for resistor substitution are:

1)  $10 + 15 = 25 \Omega$

2)  $1/R = 1/15 + 1/15 \Rightarrow 1/R = 2/15 \Rightarrow R = 15/2 = 7.5 \Omega$

3) First do the  $10 + 5 = 15\Omega$ . Then two  $15\Omega$  are connected in parallel which gives a resistance of  $7.5\Omega$  according to the formula. Finally,  $7.5 + 12.5 = 20\Omega$ .

Show how a breadboard works

#### Resistor Challenge (for advanced students)

- The students have a breadboard, 9V battery and a number of resistors. The goal of this activity is to set a specific value of current or a range and the students need to produce it.
- With a 9V battery connected, the output current (measured as shown later) is simply  $\frac{9}{R}$ , where R is the total resistance of the circuit.

- Ammeter has to be connected in series and take place of a wire in the circuit as shown below:

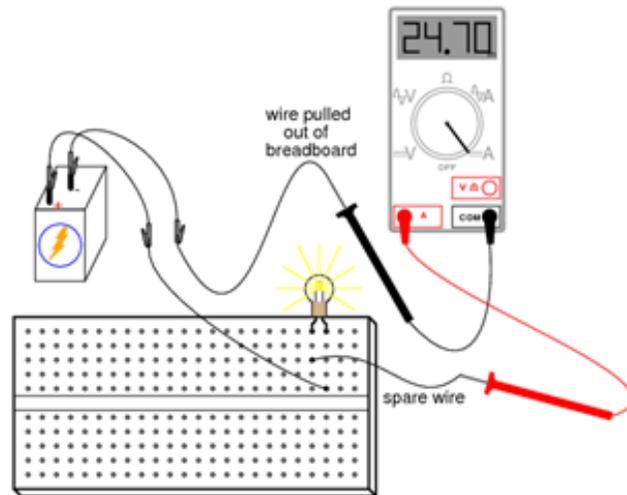

- Level 1: Create a circuit so that the output current is less than 1.5mA.
- Solution to Level 1: Connect two 5.1K resistors in series. This way the total resistance is 10K and the output current is  $9/10,200 = 0.88\text{mA}$

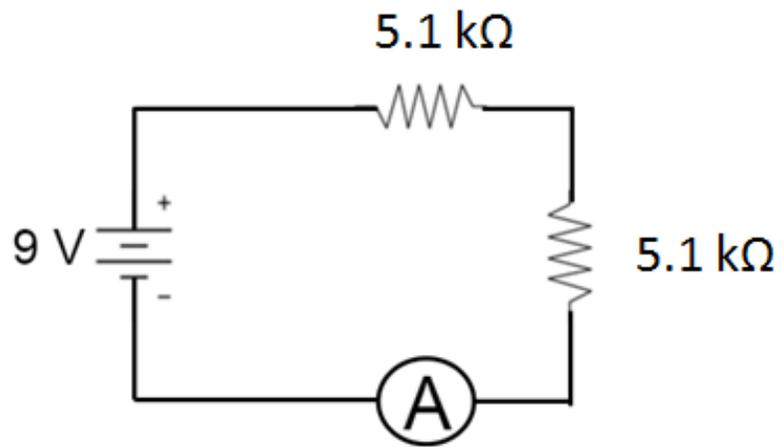

- Level 2: Create a circuit so that the output current is between 3 and 4 mA.
- Solution to Level 2: Connect two 5.1K resistors in parallel. This way the total resistance is 2.55K and the output current is  $9/2,500 = 3.53\text{mA}$



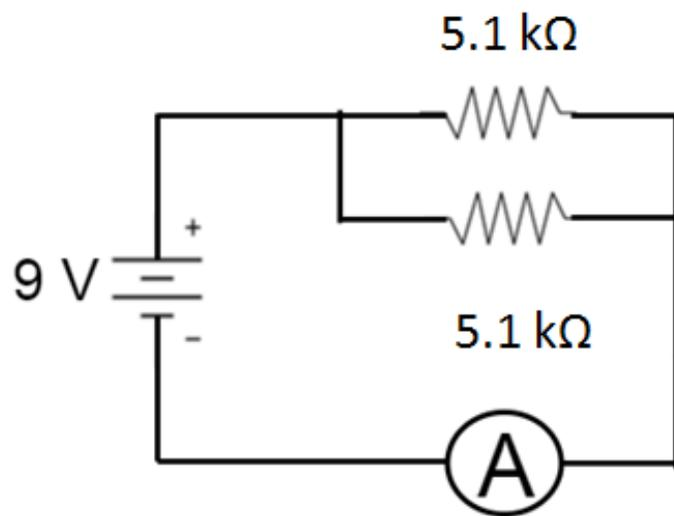

- Level 3: Create a circuit so that the output current is between 1 and 1.25 mA
- Solution to Level 3: Connect two  $5.1\text{K}$  resistors in parallel and then one  $5.1\text{K}$  resistor in series. This way the total resistance is  $2.55\text{K}+5.1\text{K}=7.65\text{K}$  and the output current is  $9/7,650=1.17\text{mA}$ .

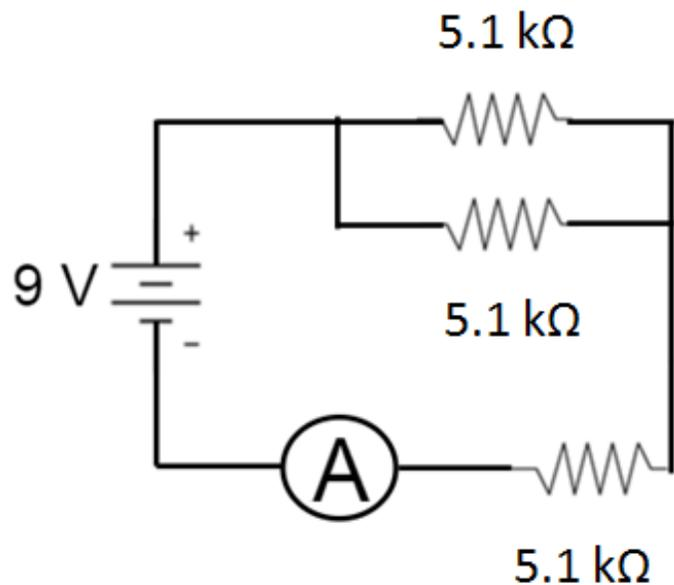

- During this activity, the presenter goes around the groups and checks with the multi-meter if the students have completed the level and offers advice.
- It is advised to not give the batteries to students until it is made certain that there is no short circuit or other problem of the circuit
  - A short circuit is when there is a loop without any output, i.e. wire going from positive pole to the negative pole of the battery without the multi-meter in between

#### Create your own Audio Amplifier

- Complete instructions on how to create the circuit are provided for the presenters.
- The presenters must solder prior to the Bootcamp. The components which need soldering are:
  - Both terminals on the speakers
  - Both terminals on the audio jack (the much smaller terminal is Input1 on the circuit diagram, the much larger terminal is Input2 on the circuit diagram)
- The students only get few hints on how to connect the LM386, the polarized capacitors and the potentiometer.

- Additional help will be provided to students who request it
  - Pictures of the next step
  - Hints on how to continue
  - Written step-by-step instructions

### 5.3 Activity 3: 3-D Printed Name Plate

- Students briefly use [Tinkercad](#) with an instructor to create a name plate
  - This name plate will be fixed to one side of the pre made case for their audio amplifier
  - An instructor will assist them in the use of [TinkerCAD](#) to make their name plates
  - This shouldn't take too long
  - It will only be a few students at a time (2-4) depending on number of computers available
  - Can reuse some of the instructions from the [Dogtag](#) activity
- Have a few examples of what can be 3-D printed
  - Have one of the titanium pieces on display
  - Have a few fun plastic prints on display
- Instructors can answer students' questions on 3-D printing while helping them with the name plate
- Name plates will be mailed to students after Bootcamp

## 5.4 More detailed background information with references

### Resistor Coding Diagram

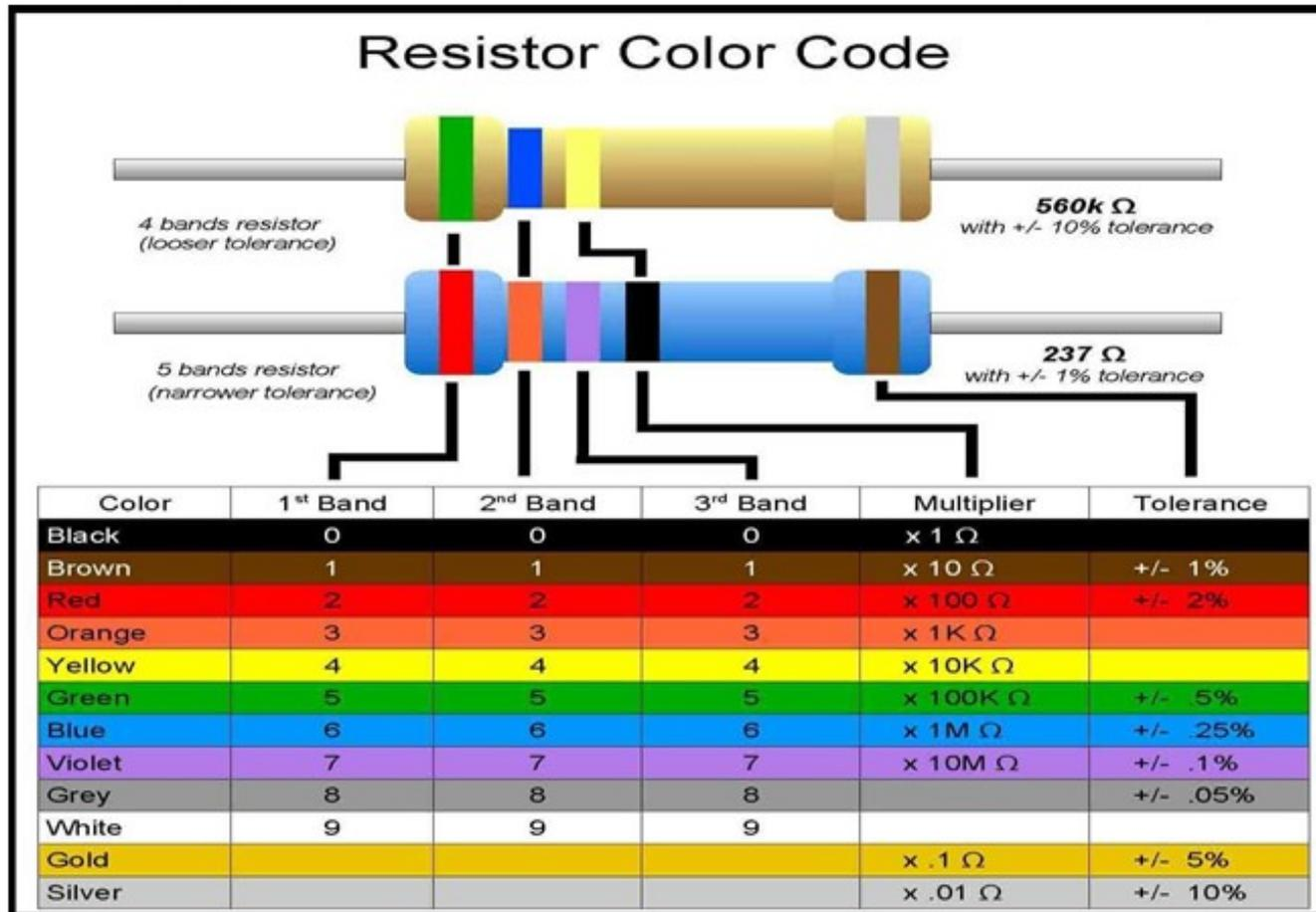

Source: [http://nearbus.net/wiki/images/7/7d/Resistor\\_color\\_codes.jpg](http://nearbus.net/wiki/images/7/7d/Resistor_color_codes.jpg)

Resistor

Source: <https://en.wikipedia.org/wiki/Resistor>

Integrated Circuit

Source: [https://en.wikipedia.org/wiki/Integrated\\_circuit](https://en.wikipedia.org/wiki/Integrated_circuit)

Operational Amplifier

Source: [https://en.wikipedia.org/wiki/Operational\\_amplifier](https://en.wikipedia.org/wiki/Operational_amplifier)

Capacitor

Source: <https://en.wikipedia.org/wiki/Capacitor>

Speaker

Source: <https://en.wikipedia.org/wiki/Loudspeaker>

## 5.5 CSIRO Stories

UltraBattery: <http://csiro.au/en/Research/EF/Areas/Energy-storage/UltraBattery>

Wearable Technology: <http://csiro.au/en/Research/Technology/Wearable-technology>

Guardian Angel: <http://csiro.au/en/Research/DPF/Areas/Autonomous-systems/Guardian?featureId=1A2262E5940C42108ED550A5ED4C51A0>

Wildlife Sound Archive: <http://www.csiro.au/en/Research/Collections/ANWC/About-ANWC/Our-wildlife-sound-archive>

MagSonic: <http://www.csiro.au/en/Research/MRF/Areas/Community-and-environment/Responsible-resource-development/MagSonic>

Research Vessel Investigator: <https://www.cmar.csiro.au/research/seamounts/documents/fr199907sum.pdf>

3D printed horse shoes: <http://www.csiro.au/Portals/Media/3D-printed-horseshoe-to-improve-racing-performance.aspx>

Sleep apnoea treatment <http://www.csiro.au/Portals/Media/3D-printed-first-to-treat-sleep-apnoea.aspx>

3D printed heel: <http://www.csiro.au/Portals/Media/3D-Heel-In-World-First-Surgery.aspx>

3d printed bugs: <http://www.csiro.au/Portals/Media/Giant-3D-printed-bugs-shed-light-on-insect-anatomy.aspx>

3d printed dragon: <http://csironewsblog.com/2014/01/10/here-be-3d-printed-dragons/>

### Electronics Projects

Electronics Projects: Beginner

Source: <http://www.instructables.com/id/Beginners-Electronics-Projects/>

Electronics Projects: Advanced

Source: <http://www.edutek.ltd.uk/Projects.html>

### Visualizing Sound

Chladni Plate

[https://en.wikipedia.org/wiki/Ernst\\_Chladni](https://en.wikipedia.org/wiki/Ernst_Chladni)

<http://www.instructables.com/id/How-to-make-a-Chladi-plate-vibrating-membrane/>

Ruben's Tube

[https://en.wikipedia.org/wiki/Rubens%27\\_tube](https://en.wikipedia.org/wiki/Rubens%27_tube)

### **Practical Applications of Sound**

Sonar

<https://en.wikipedia.org/wiki/Sonar>

Radar

<https://en.wikipedia.org/wiki/Radar>

Ultrasound

<https://en.wikipedia.org/wiki/Ultrasound>

Alternating Electrical Current

[https://en.wikipedia.org/wiki/Alternating\\_current](https://en.wikipedia.org/wiki/Alternating_current)

### **Interesting uses of 3D printing**

Good article on 3D printing applications

[https://www.linkedin.com/pulse/20141201031637-21564708-the-future-of-manufacturing?midToken=AQHVKIoZxzvX1A&trk=eml-b2\\_content\\_ecosystem\\_digest-network\\_publishes-130-null&fromEmail=fromEmail&ut=0PLsluWaV6z6w1](https://www.linkedin.com/pulse/20141201031637-21564708-the-future-of-manufacturing?midToken=AQHVKIoZxzvX1A&trk=eml-b2_content_ecosystem_digest-network_publishes-130-null&fromEmail=fromEmail&ut=0PLsluWaV6z6w1)

3D printed hermit crab shells

<http://www.iflscience.com/plants-and-animals/3d-printed-hermit-crab-shells-depict-famous-landmarks>

3D printed ear

<http://www.princeton.edu/main/news/archive/S36/80/19M40/index.xml?section=topstories>

### 3D printed liver

<http://www.computerworld.com/article/2486952/emerging-technology/the-first-3d-printed-organ---a-liver---is-expected-in-2014.html?page=3>

### exoskeleton for girl with little muscle strength

<http://www.cnet.com/news/3d-printed-magic-arms-give-little-girl-new-reach/>

### new jaw for elderly woman

<http://www.cnet.com/news/3d-printer-produces-new-jaw-for-woman/>

### 3D printing food in space (NASA)

[http://www.nasa.gov/directorates/spacetech/home/feature\\_3d\\_food\\_prt.htm](http://www.nasa.gov/directorates/spacetech/home/feature_3d_food_prt.htm)

<http://www.space.com/21250-nasa-3d-food-printer-pizza.html>

### 3D printed guns

<http://techcrunch.com/2013/09/16/original-3d-printed-liberator-guns-to-become-works-of-art-at-london-museum/>

<http://techcrunch.com/2013/05/06/what-you-need-to-know-about-the-liberator-3d-printed-pistol/>

### 3D printed functional arm for this boy

<http://www.cnet.com/news/stormtroopers-presenting-boy-with-new-3d-printed-arm-is-the-best/>

### 3D printed decorative hand

<http://3dprint.com/12993/3d-printed-prosthetic-arm/>



### 3D printed skateboards

<https://blog.solidconcepts.com/evolution-custom-manufacturing/skateboard-design-challenge-winners/>

### 3D printing on the space station

[www.madeinspace.us](http://www.madeinspace.us)

### 3D printed shoes

<http://design-milk.com/future-fit-3d-printed-float-shoes-united-nude/>

### 4D printing

Video: [http://www.ted.com/talks/skylar\\_tibbits\\_the\\_emergence\\_of\\_4d\\_printing?language=en](http://www.ted.com/talks/skylar_tibbits_the_emergence_of_4d_printing?language=en)

<http://theconversation.com/explainer-what-is-4d-printing-35696>

### Where to get models to print

Thingiverse.com

<http://www.thingiverse.com/>

### Autodesk 123D

<http://www.123dapp.com/Gallery/content/all>

### GrabCAD (engineering)

[https://grabcad.com/library?utm\\_campaign=workbench&utm\\_content=library\\_button&utm\\_medium=cta&utm\\_source=index](https://grabcad.com/library?utm_campaign=workbench&utm_content=library_button&utm_medium=cta&utm_source=index)

## 6 Equipment List

Item	Quantity	Supplier	Notes (eg order takes 6 weeks to arrive)	Unit cost
Speaker	3	eBay	Pack of 10, takes about a month to ship from China	\$6.97
Solderless Breadboard	6	eBay	Come in packs of 5	\$5.44
10 kohm potentiometer	30	Jaycar		\$0.30
47 nF capacitor	90	Jaycar	One extra per student	\$0.21
LM 386 Op Amp	1	eBay	Pack of 50, only need 30, takes up to a month to ship from China	\$3.60
100 nF capacitor	45	Jaycar	From Jaycar, need 30, ordered 60 so students have extras	\$0.30
100 uF capacitor	45	Jaycar	From Jaycar, need 30, ordered 60 so students have extras	\$0.29
220 uF capacitor	45	Jaycar	From Jaycar, need 30, ordered 60 so students have extras	\$0.28
9 V battery	30	Office Max	This cost becomes \$0 if CSIRO keeps the batteries	\$1.42
10 ohm resistor	4	Jaycar	4 packs of 8 from Jaycar	\$0.55

5K1 ohm resistor	5	<a href="#">Jaycar</a>	5 packs of 8 from <a href="#">Jaycar</a>	\$2.75
3.5mm Audio Jack	30	<a href="#">Jaycar</a>		\$0.75
1.75mm PLA 600g	3	3D Printing Superstore	From 3D printing superstore	\$32.00
White LED lights	1	eBay	From eBay, ships in 1-2 weeks	\$8.88
9V Battery Clip	30	<a href="#">Jaycar</a>		\$0.30
Jumper Wire Kit	5	eBay	Comes with wires of varying lengths, some wires may be too long to use	\$3.98
Soldering Wire	1	eBay/Storeroom (if available)	Takes a few weeks to be delivered	\$1.36
Tape	1	Woolworths	Come in spools, sometimes several per package	\$3.00
Soldering Iron	1	Storeroom	Already have on site, may need to ship to other sites	\$0.00
<a href="#">Flashforge Dreamer</a>	1	Storeroom	Already have on site, may need to ship to other sites	\$0.00
Bottles	50	Storeroom	Student groups need a set of 5 identical bottles	\$0.00
Metal Spoons	20	Storeroom/Kitchen	Should have spoons available on site, 2 spoons per group	\$0.00
Scissors	10	Storeroom	Already on site	\$0.00

Rulers	10	Storeroom	Already on site	\$0.00
Slinky	1	<del>toy store</del>	May need to purchase first	\$3.00
Pencil	10	Storeroom	Already on site	\$0.00
iPhone/iPad	2/3	Storeroom/Personnel	Needed for frequency measurement during xylophone	\$0.00
Feedback Detector	2/3	iPhone/iPad	App needed for measuring frequency during xylophone. Created by Final Mix, Inc., available in the app store	\$0.00
Computers	3	Storeroom	Needed for <del>TinkerCAD</del> , have <del>TinkerCAD</del> set up and ready to go on them.	\$0.00
			<b>Sub total</b>	<b>\$446.57</b>
			<b>+ 10% for unexpected costs</b>	
			<b>TOTAL COST</b>	<b>\$491.23</b>

# Appendix X: Magnet Activity Template

Appendix X: Magnet Activity Template

**CEdO Science Bootcamp**



Chemistry with Magnetism! (Working Title)

June 2016

# Contents

1	Two day overview .....	3
	Day 1	3
	Day 2	5
2	Hands-On Activity Program Overview .....	7
3	Activity Timeline.....	8
	3.1 Day 1. 90 min.....	8
	3.2 Day 2. 120 minutes.....	9
4	Risk Assessment .....	10
5	Presenter notes/Activity details.....	12
	5.1 Activity 1: Putty & Oil Spills.....	12
	5.2 Activity 2: Oil Spill clean-up with Magnets and Ferrofluids & Magnetic Putty.....	13
	5.3 CSIRO Stories .....	14
6	Equipment List.....	18

## 1 Two day overview

### Day 1

Time	Activity/Event	Venue	Notes	Presenter roles	Example
9:00am – 9:45am	Setup for the day			Presenters 1, 2, 3 setup	GK Williams Room
9:45am – 10:05am	Doors open Student arrival		Students arrive Need something to entertain those on time or a space for them to congregate in. Science Hangman works surprisingly well.	Presenter 2 sign-in sheet Presenters 1, 3 in room with students	GK Williams Room
10:05am – 10:15am	Behavioural expectations and safety announcement (toilets etc) Get to know you questions		See Educate file path: Public/Community Engagement/BC/BC admin and planning/BC icebreaker activities.pptx	Presenter 2 sign-in sheet Presenters 1, 3 in room with students	
10:25am – 11:00am	Presentation – CSIRO researcher		20min talk, 15min Q&A	Presenters 1,2 supervising Presenter 3 on break 10:45-11:25	
11:00am – 11:20am	Morning tea	Outdoors if weather permitting	Need time to move to first lab tour	Presenter 1, 2 supervising Presenter 3 on break 10:45-11:25	
11:30am – 1:00pm	Lab tours		Either 2x lab tours with 15 students per lab (rotate) approx. 40min per lab (with walking time) OR 2x lab tours with 10	All 3 presenters required	GK Williams Room

students per lab plus non-lab break with airplane design from 'Thinking Scientifically' or equivalent activity.

<b>1:00pm – 1:45pm</b>	Lunch	Students provide their own lunch	Presenter 1 on break (1:10 – 1:50pm) Presenter 2 on break (1:50 – 2:30)	Outdoors if weather permitting
<b>1:45pm – 3:15pm</b> (will need to adjust time)	Magnetic Putty Activity	See detailed activity breakdown for details.	Presenter 2 and 3 supervising  Presenter 1 setting up open ended activity (2:00pm – 2:15pm)	GK Williams Room/outdoors weather permitting
<b>3:15pm – 3:30 pm</b>	Wrap up, clean up.	Reminders for tomorrow	Presenter 1 sign-out sheet Presenter 2, 3 supervising	GK Williams Room
<b>3:30pm – 4:30pm</b>	Presenters clean up and re-set for day 2.		Presenters 1, 2, 3 pack up	

## Day 2



Time	Activity/Event	Venue	Notes	Presenter roles	Example
<b>9:00am – 9:45am</b>	Setup for the day			Presenters 1, 2, 3 setup	GK Williams Room  GK Williams



9:45am – 10:05am	Doors open Student arrival		Students arrive Need something to entertain those on time or a space for them to congregate in. Science Hangman works surprisingly well.	Presenter 2 sign-in sheet  Presenters 1, 3 in room with students	Room
10:10am – 11:30am	Self contained laboratory experience – Nanotechnology kit		Special notes exist for BC students. Remember you may need extra explanations at the start based on age of students.	Presenter 2 sign-in sheet  Presenters 1, 3 in room with students	
11:30am – 12:00pm	Morning tea	Outdoors if weather permitting	Students provide their own recess		
12:00pm – 12:40am	Presentation – CSIRO researcher		20min talk, 15min Q&A	Presenters 1,2 supervising Presenter 3 on break (12:00 – 12:40)	
12:40am – 1:15pm	CSIRO Quiz		Available in Bootcamp folder. Includes a physical challenge so have required lab supplies ready	Presenter 1 on break (12:40 – 1:20pm)	
1:15pm – 2:00pm	Lunch	Outdoors if weather permitting	Students provide their own lunch	Presenter 2, 3 supervising	
2:00pm – 3:30pm	Oil Spill Clean-up Activity		See below for activities in detail with timeline		Outdoors if weather permitting
3:30pm – 3:45pm	Wrap up, clean up.		Thanks <u>you</u> s to presenters and students, evaluation forms filled in, items all collected.	Presenter 1 sign-out sheet Presenter 2, 3 supervising	GK Williams Room
3:45pm – 4:45pm	Presenters clean up			Presenters 1, 2, 3 pack up	

---

## 2 Hands-On Activity Program Overview

*Program name:* Chemistry with Magnetism! (Working Title)

*Developed by:* Matthew Portugal

*Date of bootcamp/s:* May or June 2016

*Brief program outline* (max. 2-3 sentences):

Students explore basic chemistry of cross-linking and polymers to create their own magnetic thinking putty. In a self-designed experiment in order to test the effectiveness of ferrofluid and magnets in removing oil, students will become scientists testing out their hypotheses.

*Key concepts/points the program covers*

Chemistry of Magnetic Putty

- Polymer

- Cross-linking

### 3D Printing

- Basic [TinkerCad](#) tutorial
- Designing name and shapes

### Oil Spills

- Occurrences
- Wildlife affected
- Current Clean-up Technology

### Magnets and [Ferrofluid](#)

- Different types of magnets
- What is [ferrofluid](#)
- Basic Chemistry of [ferrofluid](#)

### Magnets in Oil Spills

- Cleaning an oil spill with the use of magnets and magnetic materials

## 3 Activity Timeline

### 3.1 [Day 1, 90 min](#)



Time (min)	Event	Notes
------------	-------	-------

0-20	Background Chemistry	<ul style="list-style-type: none"> <li>• Overview and Putty video (5 minutes)</li> <li>• Polymer overview (10 minutes)</li> <li>• Cross-linking &amp; Activity (5 minutes)</li> </ul>
20-40	Making Putty	<ul style="list-style-type: none"> <li>• Safety overview (5 minutes)</li> <li>• Making and Kneading putty (15 minutes)</li> </ul>
40-65	<u>TinkerCAD</u>	<ul style="list-style-type: none"> <li>• CSIRO connections &amp; video (7 minutes)</li> <li>• <u>TinkerCAD</u> tutorials (8 minutes)</li> <li>• Design lid (10 minutes)</li> </ul>
65-86	Oil Spill and Clean-up	<ul style="list-style-type: none"> <li>• Oil Spill facts (3 minutes)</li> <li>• Wildlife affected (3 minutes)</li> <li>• Feather demonstration (15 minutes)</li> </ul>

### 3.2 Day 2, 120 minutes



Time (min)	Event	Notes
0-18	<u>Ferrofluid</u>	<ul style="list-style-type: none"> <li>• <u>Ferrofluid</u> chemistry (10 minutes)</li> <li>• Normal magnet vs neodymium on <u>ferro fluid</u> (3 minutes)</li> </ul>

		<ul style="list-style-type: none"> <li>• Electromagnet Demonstration(5 minutes)</li> </ul>
18-34	Explain the lab	<ul style="list-style-type: none"> <li>• Overview of the lab and student expectations (5 minutes)</li> <li>• Write hypothesis and reasoning (3 minutes)</li> <li>• Safety (5 minutes)</li> <li>• Break into groups and distribute materials (3 minutes)</li> </ul>
34-46	Design experiment	<ul style="list-style-type: none"> <li>• Design and write out lab procedure (10 minutes)</li> <li>• Get procedure approved(2 minutes)</li> </ul>
46-71/81	Perform experiment	<ul style="list-style-type: none"> <li>• Perform experiment (20-30 minutes)</li> <li>• Write conclusions (5 minutes)</li> </ul>
71/81-90	Clean-up and discussion	<ul style="list-style-type: none"> <li>• Clean-up all materials except glassware (10 minutes)</li> <li>• Discuss each groups findings with the class</li> </ul>
90-102	Magnetize Putty	<ul style="list-style-type: none"> <li>• What is Black Iron Oxide Powder (2 minutes)</li> <li>• Magnetize putty (10 minutes)</li> </ul>
102-120	Wrap up	<ul style="list-style-type: none"> <li>• Play with putty and magnets</li> <li>• Wrap up</li> </ul>

## 4 Risk Assessment



Type of hazard	Description of task or activity	Inherent risk			Existing Controls	Residual Risk		
		High	Medium	Low		High	Medium	Low
Burns from extruder and print bed on 3D printer	The extruder in the 3D printer is heated to 200°C and the bed is heated to 100C		X		<ul style="list-style-type: none"> <li>The printer is enclosed so students cannot touch,</li> <li>Students are supervised and only allowed to observe the printer working</li> <li>The presenters are the only ones to use the printer and they are instructed on how to use it safely</li> <li>Printer automatically cools the extruder and bed to room temp when not in use (only takes 3-5mins)</li> </ul>			X
Electrocution	Some equipment (eg 3D printer, computers if plugged into power) powered from a mains power supply.		X		<ul style="list-style-type: none"> <li>All electrical equipment to be electrically tested annually</li> <li>Access to power point is as restricted as possible within the limits of the specific room.</li> </ul>			X
Pinching	Fingers might get pinched between neodymium			X	<ul style="list-style-type: none"> <li>Keeping neodymium magnets glued to Popsicle sticks.</li> <li>Students should be careful when using neodymium magnets close to each other.</li> </ul>			X

magnets.

<b>Eye Injury</b>	Students may poke themselves in the eyes with popsicle sticks or splash chemicals into their eyes. (Borax solution, oleic acid, vegetable oil).	X	<ul style="list-style-type: none"><li>• Have students wear safety glasses</li><li>• Instructors should supervise students, making sure that they are not being reckless.</li></ul>	X
<b>Digestion</b>	Student consumption of <u>pyva</u> glue, borax, oleic acid, iron oxide, mineral oil, or vegetable oil.	X	<ul style="list-style-type: none"><li>• Except the oleic acid, the rest of the products are safe if accidentally consumed</li><li>• Warn students not to consume any products used and to wash their hands whenever they are taking off their gloves.</li></ul>	X
<b>Stains</b>	<u>Ferrofluid</u> will stain skin and clothing.	X	<ul style="list-style-type: none"><li>• Warn students that the <u>ferrofluid</u> is very messy and to be careful when working with it.</li><li>• Students will be wearing gloves, safety glasses, and an apron.</li></ul>	X

## 5 Presenter notes/Activity details

### 5.1 Activity 1: Putty & Oil Spills

#### Outline

- Magnetic putty video
- Introduce Chemistry of PVA glue and Borax
  - Polymers
  - Cross-linking
    - Activity with cross-linking
- Making Putty
  - Discuss safety concerns
  - Students prepare their materials
  - Make & Knead the Putty
- TinkerCAD
  - Go over CSIRO 3D printing
  - Students run through TinkerCAD tutorials
  - Students design lids
- Introduction to Oil Spills
  - Go over facts and on oil spills
  - Current oil spill clean-up technology



- Feather Cleaning demonstration for students
- Materials needed:
  - Safety Glasses x30
  - Disposable Gloves x30 pairs (1 pair per student)
  - Popsicle Sticks x 60
  - Plastic Spoons x 60
  - Plastic Ziploc Bag x 30
  - PVA Glue x 1-2L (includes extra)
  - Borax Powder x 500g (includes extra)
  - Tap Water
  - Paper Towels (Not napkins or tissues, the paper is too weak)
  - Handouts/Instructions

## 5.2 Activity 2: Oil Spill clean-up with Magnets and Ferrofluids & Magnetic Putty

- Introduction to Magnets and Ferrofluid
  - Go over the different types of magnets
  - Properties of magnets
  - What is Ferrofluid and its chemistry
  - Surfactant
- Hypothesis
  - Have each student form a strong hypothesis
- Break into groups and go over experiment
  - Have students design an experiment
  - Have students perform their experiment
  - Make conclusions and have a group discussion
- Magnetize Putty
  - Background on black iron oxide powder
  - Add powder to putty
- Demonstrate putty
  - Demonstrate thinking putty
  - Demonstrate making the putty able to pick up iron

- Students Play with Putty
- Materials needed:
  - Disposable Gloves x 60 pairs (2 pairs per student)
  - Safety Glasses x30
  - Large rectangle dish to work in in case of spills x10
  - Disposable apron x 30
  - Petri dishes x 40
  - Plastic cup x20
  - Food colouring to colour water
  - Vegetable oil x1 bottle
  - Plastic transfer pipettes x30
  - Zip lock bags 050x075x.040 mm x40
  - Paper towels
  - Oleic Acid x10 teaspoons
  - 10mL graduated Cylinder x10
  - Funnel x10
  - Feather x4
  - Dawn Dish Soap
  - Iron Oxide Powder x 2kg (includes extra)
  - Plastic Spoons x 30
  - Disposable Plastic Bowl x 30

### 5.3 CSIRO Stories

RAFT Polymerisation: <http://www.csiro.au/en/Research/MF/Areas/Chemicals-and-fibres/Chemistry-and-biotechnology/RAFT>

International Marine Incident Response Operations: <http://www.csiro.au/en/Research/OandA/Areas/Coastal-management/Marine-incident-response/International-response-operations>

Polymer Banknotes: <http://www.csiropedia.csiro.au/display/CSIROpedia/Polymer+banknotes>

Lab 22: <http://www.csiro.au/en/Research/MF/Areas/Metals/Lab22>

3D printed horse shoes: <http://www.csiro.au/Portals/Media/3D-printed-horseshoe-to-improve-racing-performance.aspx>

Sleep apnoea treatment <http://www.csiro.au/Portals/Media/3D-printed-first-to-treat-sleep-apnoea.aspx>

3D printed heel: <http://www.csiro.au/Portals/Media/3D-Heel-In-World-First-Surgery.aspx>

3d printed bugs: <http://www.csiro.au/Portals/Media/Giant-3D-printed-bugs-shed-light-on-insect-anatomy.aspx>

3d printed dragon: <http://csironewsblog.com/2014/01/10/here-be-3d-printed-dragons/>

### **Interesting uses of 3D printing**

Good article on 3D printing applications

[https://www.linkedin.com/pulse/20141201031637-21564708-the-future-of-manufacturing?midToken=AQHVKIoZxzvX1A&trk=e1-b2\\_content\\_ecosystem\\_digest-network\\_publishes-130-null&fromEmail=fromEmail&ut=0PLsluWaV6z6w1](https://www.linkedin.com/pulse/20141201031637-21564708-the-future-of-manufacturing?midToken=AQHVKIoZxzvX1A&trk=e1-b2_content_ecosystem_digest-network_publishes-130-null&fromEmail=fromEmail&ut=0PLsluWaV6z6w1)

3D printed hermit crab shells

<http://www.iflscience.com/plants-and-animals/3d-printed-hermit-crab-shells-depict-famous-landmarks>

3D printed ear

<http://www.princeton.edu/main/news/archive/S36/80/19M40/index.xml?section=topstories>

3D printed liver

<http://www.computerworld.com/article/2486952/emerging-technology/the-first-3d-printed-organ---a-liver---is-expected-in-2014.html?page=3>

exoskeleton for girl with little muscle strength

<http://www.cnet.com/news/3d-printed-magic-arms-give-little-girl-new-reach/>

new jaw for elderly woman

<http://www.cnet.com/news/3d-printer-produces-new-jaw-for-woman/>

3D printing food in space (NASA)

[http://www.nasa.gov/directorates/spacetech/home/feature\\_3d\\_food\\_prt.htm](http://www.nasa.gov/directorates/spacetech/home/feature_3d_food_prt.htm)

<http://www.space.com/21250-nasa-3d-food-printer-pizza.html>

3D printed guns

<http://techcrunch.com/2013/09/16/original-3d-printed-liberator-guns-to-become-works-of-art-at-london-museum/>

<http://techcrunch.com/2013/05/06/what-you-need-to-know-about-the-liberator-3d-printed-pistol/>

3D printed functional arm for this boy

<http://www.cnet.com/news/stormtroopers-presenting-boy-with-new-3d-printed-arm-is-the-best/>

### 3D printed decorative hand

<http://3dprint.com/12993/3d-printed-prosthetic-arm/>

### 3D printed skateboards

<https://blog.solidconcepts.com/evolution-custom-manufacturing/skateboard-design-challenge-winners/>

### 3D printing on the space station

[www.madeinspace.us](http://www.madeinspace.us)

### 3D printed shoes

<http://design-milk.com/future-fit-3d-printed-float-shoes-united-nude/>

### 4D printing

Video: [http://www.ted.com/talks/skylar\\_tibbits\\_the\\_emergence\\_of\\_4d\\_printing?language=en](http://www.ted.com/talks/skylar_tibbits_the_emergence_of_4d_printing?language=en)

<http://theconversation.com/explainer-what-is-4d-printing-35696>

## Where to get models to print

Thingiverse.com

<http://www.thingiverse.com/>

Autodesk 123D

<http://www.123dapp.com/Gallery/content/all>

GrabCAD (engineering)

[https://grabcad.com/library?utm\\_campaign=workbench&utm\\_content=library\\_button&utm\\_medium=cta&utm\\_source=index](https://grabcad.com/library?utm_campaign=workbench&utm_content=library_button&utm_medium=cta&utm_source=index)

## 6 Equipment List



Item	Quantity	Supplier	Notes (eg order takes 6 weeks to arrive)	Unit cost
Disposable Gloves	180	On Sight/ officeworks.com.au	<a href="http://www.officeworks.com.au/shop/officeworks/c/facilities-supplies/cleaning/cleaning-equipment/gloves/disposable-safety-gloves">http://www.officeworks.com.au/shop/officeworks/c/facilities-supplies/cleaning/cleaning-equipment/gloves/disposable-safety-gloves</a> Each student will need 3 pairs for <u>bootcamp</u>	\$19.34
Safety Glasses	30	On sight	Each Student needs a pair	\$0.00
Clear Plastic Cups	80	On sight/Woolworths	Does not hurt to have extras	\$12.00
Popsicle Sticks	30	Woolworths	Come in packs of 100	\$4.00
Plastic Spoons	90	Woolworths	Comes in packs of 100	\$1.74
Measuring Spoons	10	On Sight	Would help to have ¼ and ½ teaspoons	\$0.00
Disposable Plastic Bowl	30	Woolworths	Price for a 30 pack	\$0.00
Plastic Ziploc Bag 050x075x.040 mm	70	On Sight	There is a box of thousands of them from the slime activity at holiday programs	\$2.82

<b>PVA Glue</b>	2L	Artstoreonline.com.au	2L will be plenty of glue, 1L may be enough <a href="https://www.artstoreonline.com.au/glues/pva-glues/helmar-kids-pva-school-glue-1-litre/prod_2647.html">https://www.artstoreonline.com.au/glues/pva-glues/helmar-kids-pva-school-glue-1-litre/prod_2647.html</a>	\$17.60
<b>Borax Powder</b>	500g	Shop.coles.com.au	<a href="http://shop.coles.com.au/online/national/bare-essentials-borax">http://shop.coles.com.au/online/national/bare-essentials-borax</a> This 500g will be enough for all <u>bootcamps</u>	\$4.52
<b>Iron Oxide Powder</b>	2kg	Greenlivingaustralia.com.au	Already purchased 2kg, which is enough for all <u>bootcamps</u> Price here is for 1/6 <sup>th</sup> of the 2kg bag	\$28.00
<b>Paper Towels</b>	12 pack	Woolworths	Will be plenty of paper towels for the students	\$22.00
<b>Large Rectangle Dish</b>	10	Woolworths	Will keep the work areas clean for students, extras can keep areas cleaner	\$10.00
<b>Disposable Apron</b>	30	On Sight	Lab coats are preferred but disposable aprons will work fine. Used to keep <u>ferrofluid</u> off students clothing	\$0.00
<b>Petri Dish</b>	40	On Sight	Plastic petri dishes work	\$0.00
<b>Food Coloring</b>	1	Woolworths	Any colour, used to colour the water in petri dishes	\$0.88
<b>Vegetable oil</b>	750mL	Woolworths	Any Vegetable oil	\$2.25
<b>Plastic Transfer Pipettes</b>	30	On Sight	Each group will need 3 for Day 2 of Bootcamp	\$0.00
<b>Oleic Acid</b>	1L	Sigma Aldrich	<a href="http://www.sigmaaldrich.com/catalog/product/aldrich/364525?lang=en&amp;region=AU">http://www.sigmaaldrich.com/catalog/product/aldrich/364525?lang=en&amp;region=AU</a>	\$12.16



Should be enough for all bootcamps. Price is for 1 bootcamp				
<b>Mineral Oil</b>	16 oz	Woolworths	Will be plenty	\$6.00
<b>Neodymium Magnets</b>	Many	Aussiemagnets.com.au	Shipping is expensive, so buy all of them at once. Buy a 100 pack of small disks (\$15). Buy bigger magnets for demonstrations and students to play with	\$15+extras for demonstration
<b>Feather</b>	4	Ebay	<a href="http://www.ebay.com.au/itm/10pcs-WHITE-Goose-Feathers-6-8-inch-15-20cm-/131658986903">http://www.ebay.com.au/itm/10pcs-WHITE-Goose-Feathers-6-8-inch-15-20cm-/131658986903</a> Can buy a 10 pack of white feathers here	\$4.00
<b>Cocoa Powder</b>	2Tbs	On Sight	Just used to colour the vegetable oil to look like crude oil	\$0.00
<b>Graduated Cylinder</b>	10	On Sight	Need small graduated cylinders to measure oil left	\$0.00
<b>Funnel</b>	10	On Sight	Need to pour from petri dish into graduated cylinder	\$0.00
<b>Flashforge Dreamer</b>	1	Storeroom	Already have on site, may need to ship to other sites	\$0.00
<b>Laptop</b>	30	Student	Student brings their own for day 1 to use TinkerCAD	\$0.00
<b>Sub total</b>				\$118+extra neodymium magnets
<b>+ 10% for unexpected costs</b>				
<b>TOTAL COST</b>				<b>\$130.00</b>

## Appendix Y: Summative Team Evaluation

During IQP, our team worked successfully together to understand the strengths and weaknesses of each member and to adapt to others' working styles to complete our project and report professionally.

### **Effective Strategies:**

We listed tasks at the beginning of the day and assigned them to specific people. This worked well for the variety of working styles on our team. The members who needed organization appreciated a list of goals and it helped set deadlines for the members who sometimes procrastinated. Team members made sure to communicate concerns to one another about various portions of the project. Team members were assigned specific tasks, such as writing a portion of a chapter or developing portions Bootcamp activities. Assigning team members different tasks allowed each team member to focus on their aspect of the overall project. It also allowed for other team members who finished their assigned tasks to assist other team members if necessary. We all collaborated before turning in documents for submission to make sure each team member agreed with the chapter material.

We have learned to take the advisors comments less personally to allow for meaningful group discussions. We take the comments and compare them to what was previously written to find the optimal way of fixing that section. Early in the term, there would be some argument about the comments instead of discussing and correcting them like we have been doing for the past several weeks. When a comment has stumped all of us collaborating together, we have brought them up in our advisor meetings to gain more elaboration and clarity on what the advisors are looking for.

### **Areas for Improvement:**

In future teamwork experiences, we all see areas in which we could improve as a team. We could improve our overall team focus on broad goals by meeting stricter deadlines and putting a team effort into each individual aspect. Each team member could improve their communication skills by being more receptive to the ideas of other team members. This means looking at a situation from another team member's point of view and respecting their opinions. We found that each team member had different styles of completing work. There is still room for improvement in how we complete work as a team by understanding how each team member completes work and finding a way to put those work styles together.