

ABSTRACT

With the percentage of the elderly population rapidly increasing as the baby boomer generation reaches retirement, the demand for assistive care needed will soon override the supply of caregivers available. Thus, the robotic industry has emerged with alternative solutions to this challenge. Through FRASIER, the team developed an assistive robot with a goal of supporting the care of elderly and individuals with age-related disabilities to help restore daily independence. The team determined the robot functionalities by conducting user studies through surveys and interviews to potential users. From these user study results, the team developed a user-friendly mobile robot incorporating both aesthetic and companionship aspects. FRASIER will ultimately be able to interact with its environment and users through a robotic manipulator, cameras, and user interface.

USER CENTERED DESIGN APPROACH

Three studies were conducted to determine most desired robot functionalities.

STUDY 1

Possible Features of Personal Assistant Robot

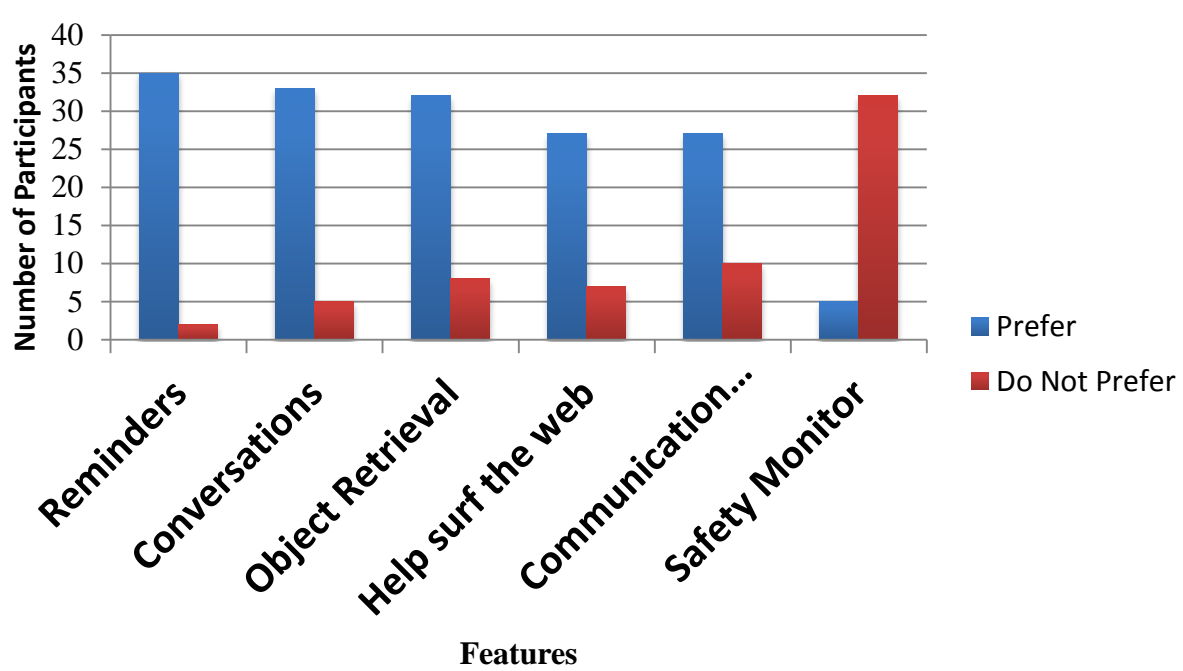

STUDY 2

Highest Rated Functions

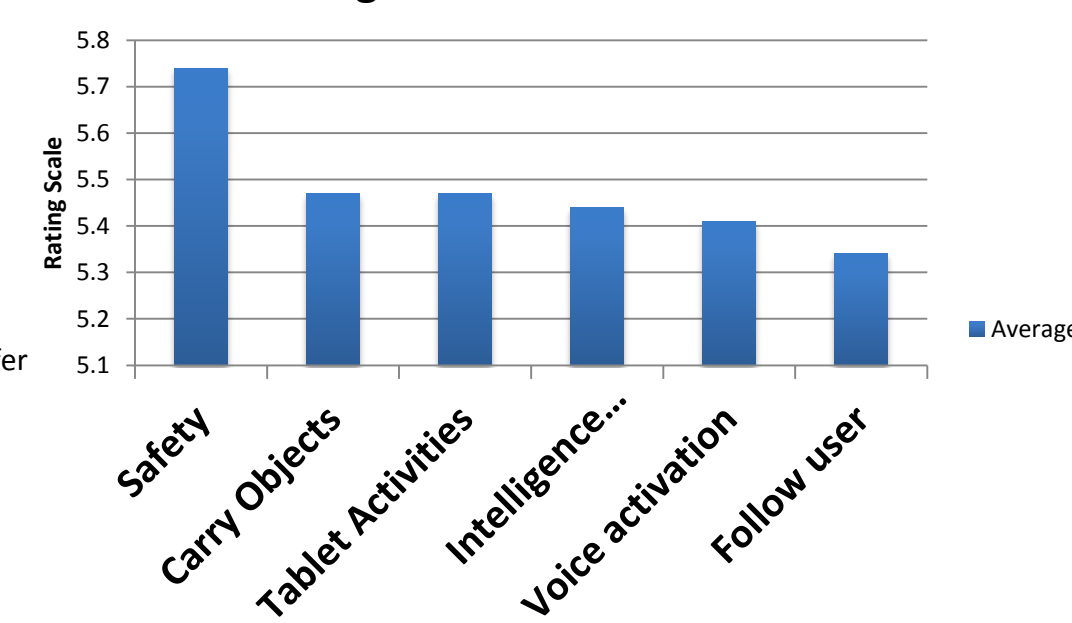

STUDY 3

Highest Rated Functions

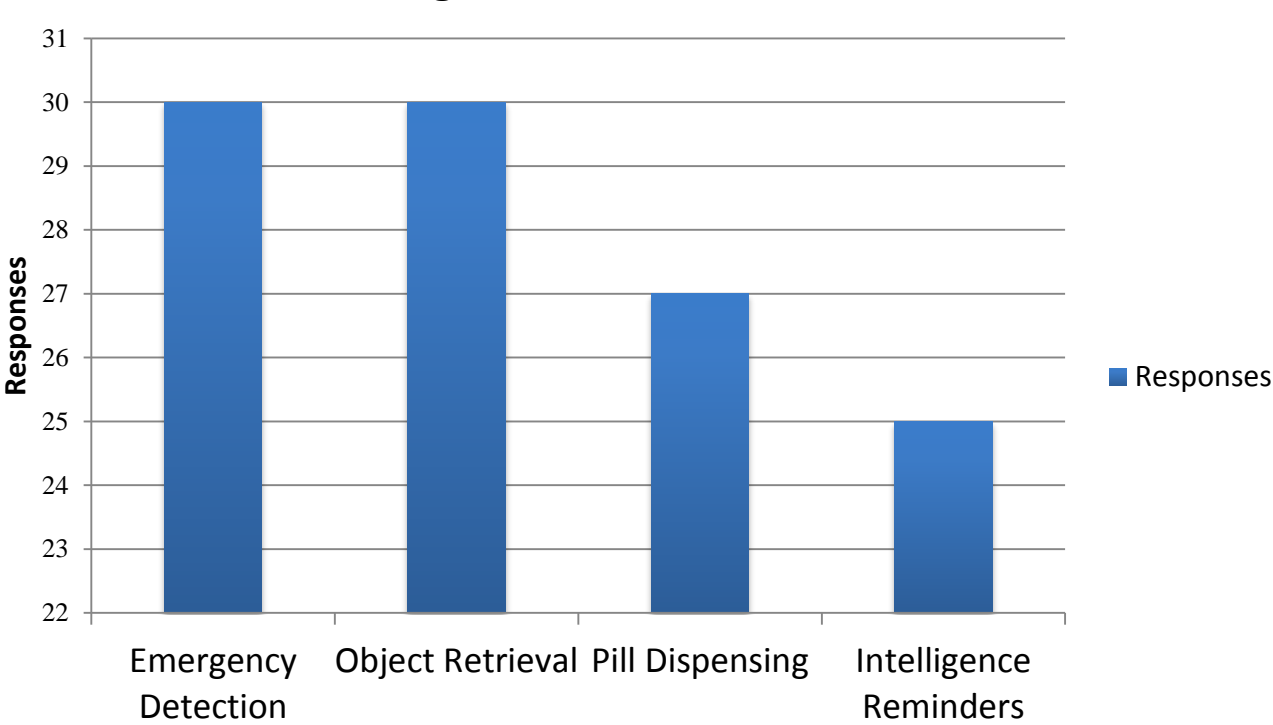

STUDY 3 COMMON THEMES:

- Cost
- Size
- Human Care vs. Robot Care

ROBOT SYSTEM OVERVIEW

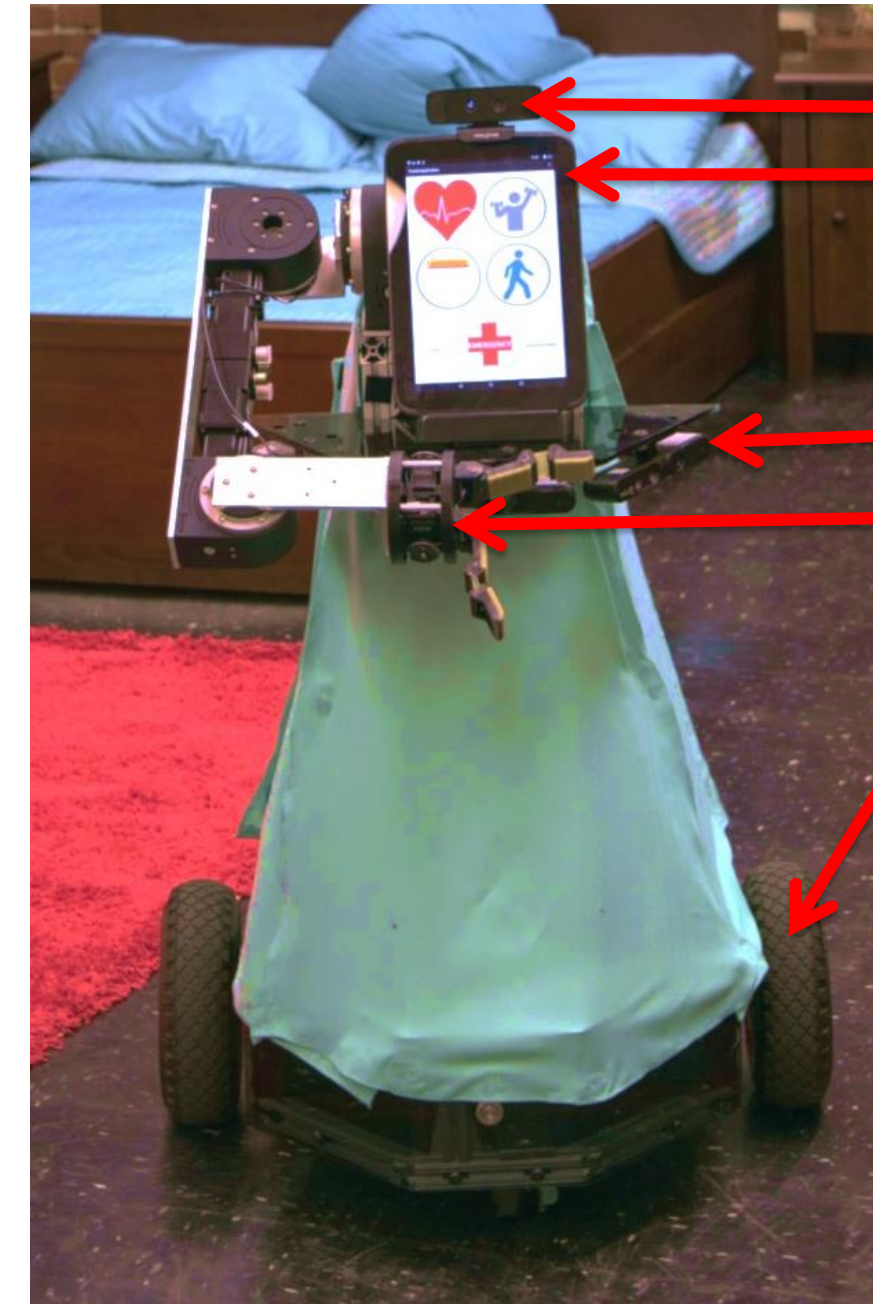

Design Requirements

- Object Detection & Recognition
- Graphical User Interface
- Non-Threatening
- Easy to Use
- Robust Indoor Navigation
- Robotic Manipulator
- Modular Robot Base

Results

- Robot designed from User Studies
- Object Detection & Recognition
- User Friendly Application
- Joint Control of the Manipulator
- Narrow Passage Navigation
- ARTags for localization
- Base successfully built

ROBOTIC MANIPULATOR

- 3 Degrees of Freedom (DOF) each joint by igus Robolink D with worm gearbox integrated
- Prefabricated 2 DOFs under actuated fingers
- Joint control by Arduino and messages from ROS

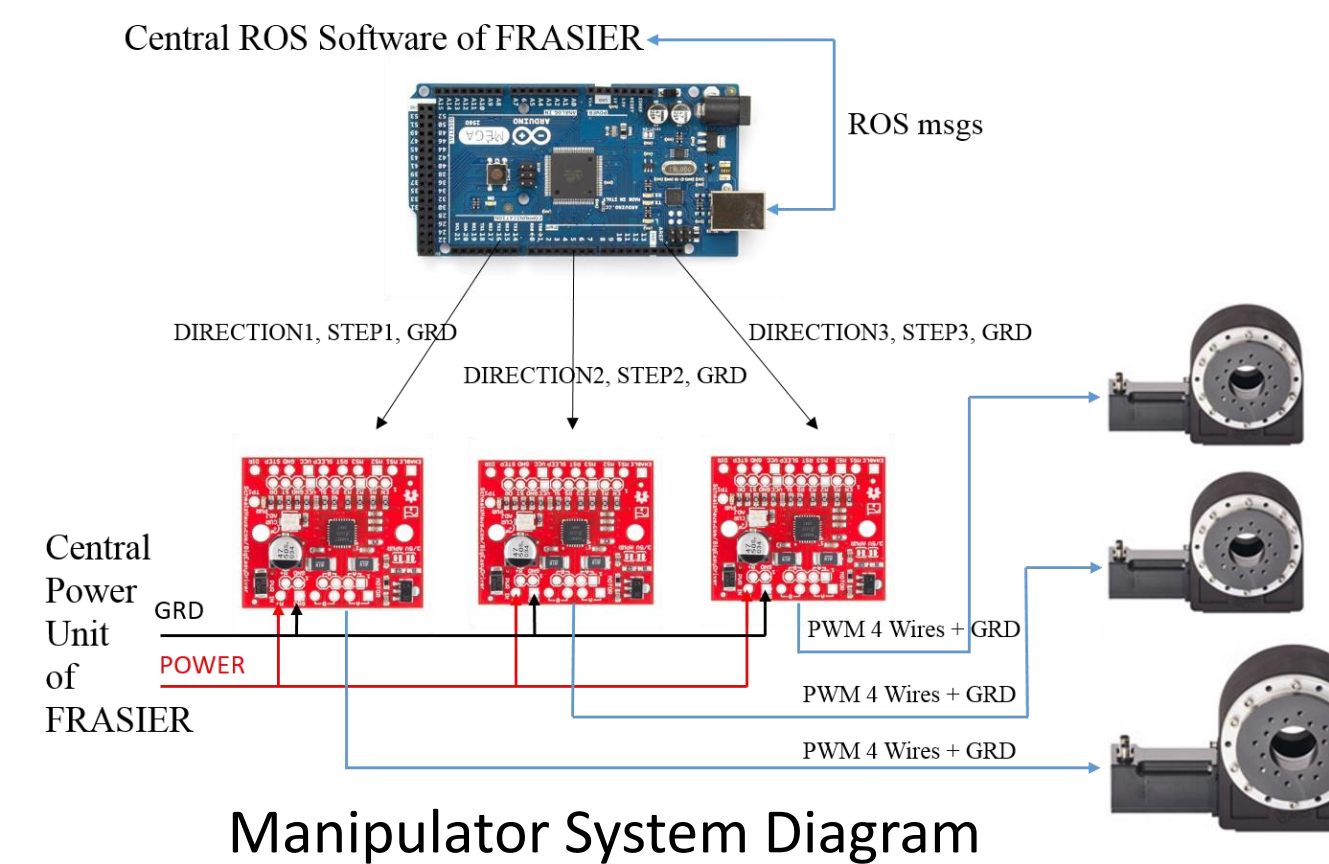

NAVIGATION

- Dynamically-controlled Navigation Planner for Holonomic Mobile Robot
- A* , SLAM, ARTag for Home Living Environment Localization

GRAPHICAL USER INTERFACE (GUI)

FRASIER is equipped with its own android application. This touch screen application can control robot functions as well as provide users with easy access to a blood pressure monitor, physical therapy exercises, a daily calendar and more. When FRASIER is in operating mode the friendly cartoon face accompanies the user.



ADDITIONAL FEATURES

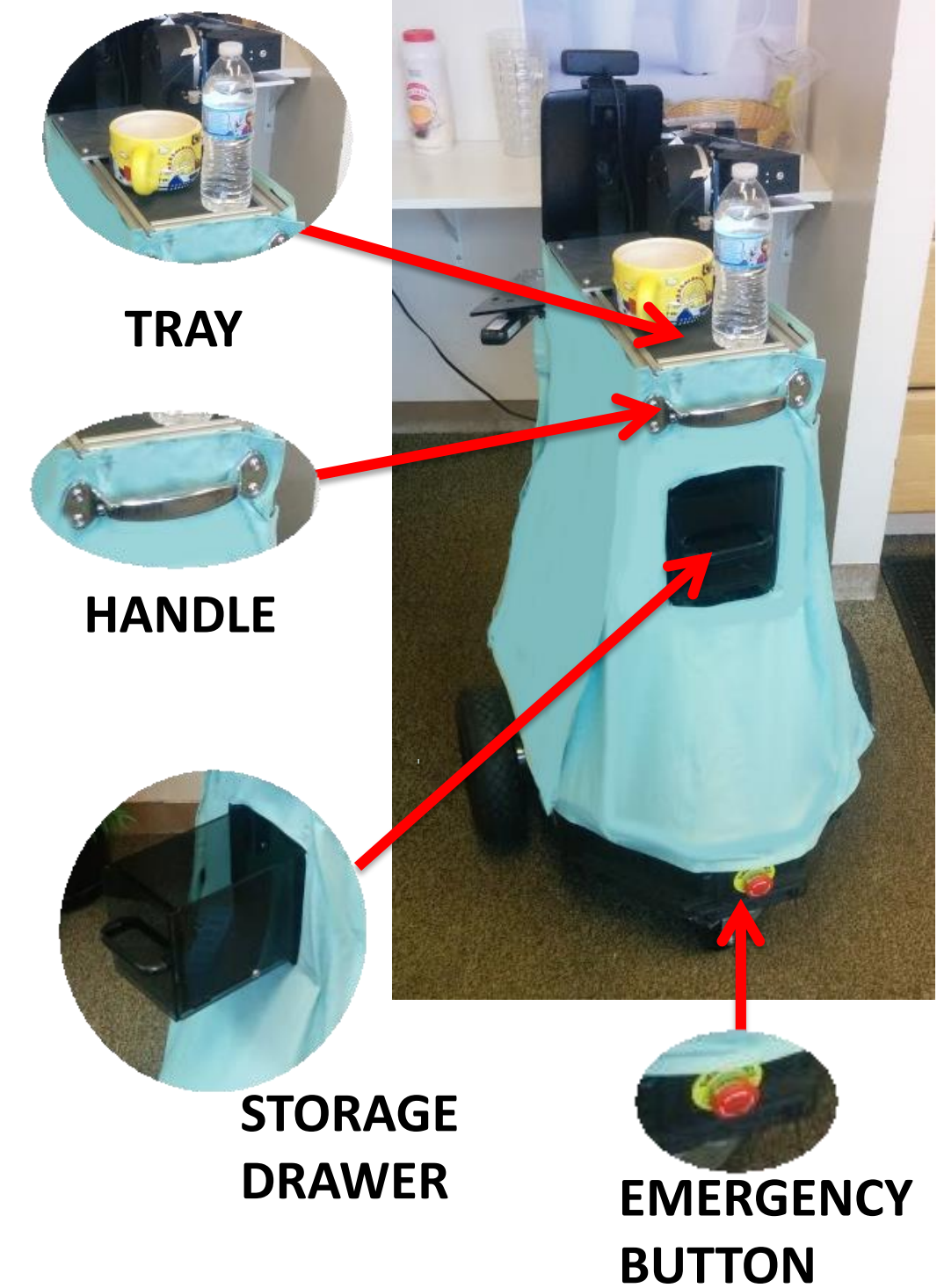

COMPUTER VISION

Object Recognition and pose estimation in highly clustered environment using RGBD sensor (Creative Senz3D).

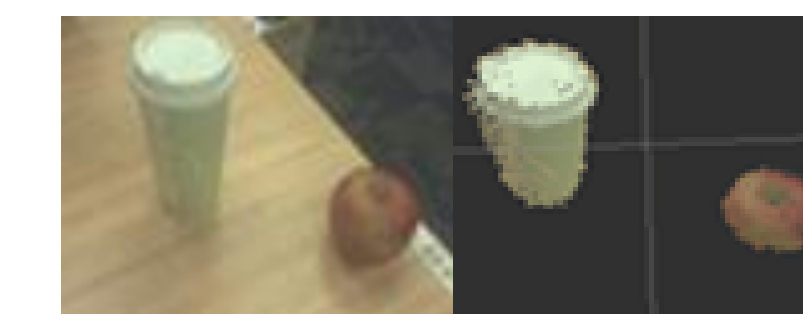

Segmented Objects



Number of Objects Identified

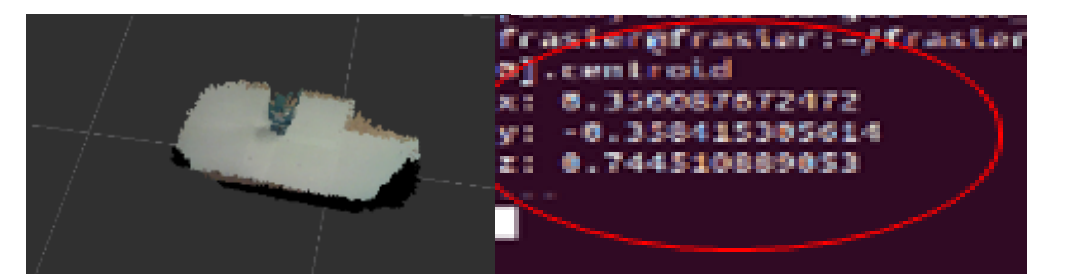
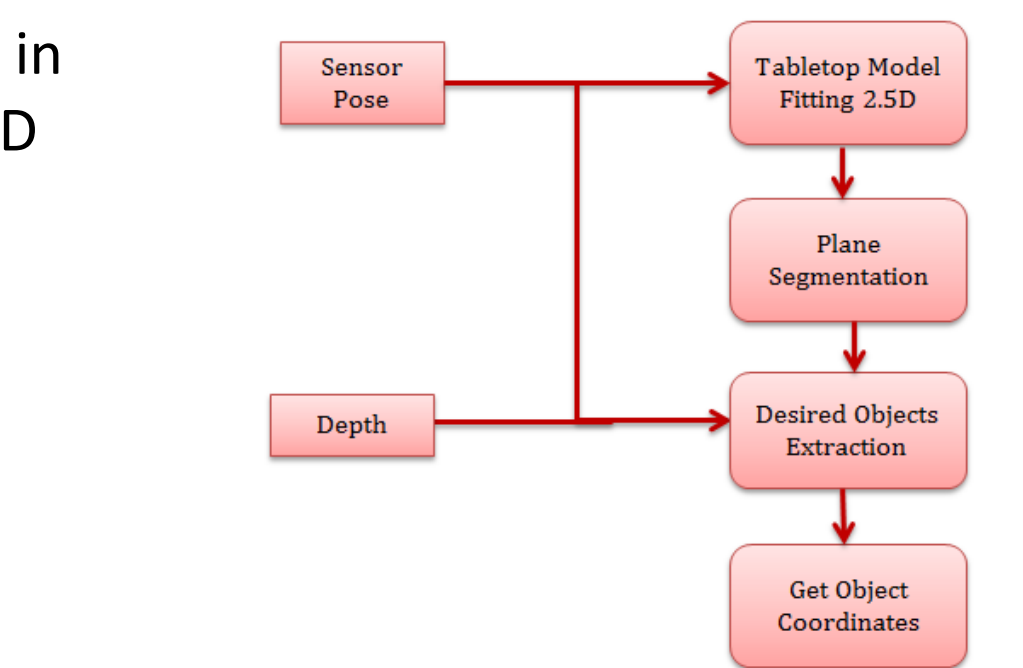

Coordinates of Object

Acknowledgments

The FRASIER group would like to thank our advisors, Fred Looft, Robert Boisse, Robert Brown, Joe St. Germain, Tracey Coetzee, Velin Dimitrov, Dimitry Sinyukov, Russell Toris, Nandan Banerjee, Nicholas Otero, the members of the PARbot team and the many participants of the user studies for their help in bringing this project to its fruition.

References

1. Ortman Jennifer M, Velkoff Victor A, & Hogan Howard. (2014). An Aging Nation: The older. Population in the United States. United States Census Bureau
2. Werner Carrie A. (2010). The older population: 2010. United States Census Bureau.

Sponsor



This material is based upon work supported by the National Science Foundation under Grant No. 1264588.