



# Making Mirabib Marketable: Designing an Environmentally Sustainable Campsite in Namibia's Namib-Naukluft Park



Katie Candiloro  
Julian Dano  
Jaime Espinola  
Daniel Thiesse



# Making Mirabib Marketable: Designing an Environmentally Sustainable Campsite in Namibia's Namib-Naukluft Park

An Interactive Qualifying Project Report  
Submitted to the Faculty of  
Worcester Polytechnic Institute and the  
Gobabeb Research and Training Centre

Submitted by:  
*Katie Candiloro*  
*Julian Dano*  
*Jaime Espinola*  
*Daniel Thiesse*

Submitted on:  
May 7, 2015

Submitted to:  
Dr. Gillian Maggs-Kölling  
Gobabeb Research and Training Centre

Project Advisors:  
Professor Thomas B. Robertson and Professor Holly K. Ault

IQP Sequence Number: TBR D151



This Report represents the work of four WPI undergraduate students submitted to the faculty as evidence of completion of a degree requirement. WPI routinely publishes these reports on its website without editorial or peer review. For more information about the projects program at WPI, please see <http://www.wpi.edu/Academics/Project>

## Abstract

In Namibia's Namib-Naukluft Park lies a remote granite inselberg, Mirabib, which provides shelter for seven isolated campsites. Mirabib's remoteness makes managing the campsites difficult, while the combination of visitor activity and basic amenities leads to environmental damage. The goal of this project was to promote environmentally sustainable tourism at the Mirabib Campsites. From on-site observations, interviews with stakeholders, and studies of campsite best practices, we found that marketable campsites with well managed infrastructure improve visitor experience while decreasing environmental damage. Therefore, we recommended infrastructure designs, management plans, and marketing strategies to increase environmentally sustainable tourism at the Mirabib Campsites.

## Acknowledgements

There are many people and organizations that made this project possible. The team would like to thank everyone that contributed to the project. Special thanks go out to:

**Dr. Gillian Maggs-Kölling** for her continued support and patience throughout the project.

**Ms. Patty Murphy-Geiss** for her time and supervision, and for being a mentor while at the station.

**Ms. Elna Irish** for her time and energy to ensure that we were accommodated at the station.

**Mr. Peter Buechler:** For his guidance and help to keep us down to Earth.

**Dr. Eugene Marias** for continually enlightening us with his knowledge about everything.

**Mr. Rodney Amster** for his expertise and for encouraging us to dream big.

**Gobabeb Research and Training Centre** for sponsoring our project and for all of the resources they put into this project.

**Journeys Namibia** for the comfortable office space and copious amounts of coffee while working in Windhoek.

**Namibia's Ministry of Environment and Tourism** for allowing us access to their library.

**Polytechnic of Namibia** for accesses to their library and wireless internet.

**Professor Thomas Robertson and Professor Holly Ault** for the continued guidance, feedback, and aid to make this project that best that it can be.

**Professor Seth Tuler** for the support, guidance, and feedback during the preparatory phase of this project.

**Ms. Lynn Riley** for her aid in completing research through the WPI library.

**Professor Creighton Peet** for organizing this project and other details to make it possible to spend a term in Namibia.

**WPI Interdisciplinary and Global Studies Division** for the opportunity to travel to Namibia for a term and complete this project.

## Executive Summary

Approximately eight billion people visit national parks each year to observe the natural beauty (Balmford, 2015; Lema, 2009). To preserve the national parks, infrastructure must be limited; however, low infrastructure can cause environmental damage through unmonitored trash and visitor activity. Along Namibia's Atlantic coast lies one of the oldest deserts on earth, the Namib Desert. To help prevent environmental destruction and to allow for the tourism industry to expand, Namibia's Ministry of Environment and Tourism (MET) established protected regions of the Namib Desert including the Namib-Naukluft Park (NNP) (Namibia Tourism Board, 2015).

The Namib-Naukluft Park (NNP), the largest protected area in Namibia, contains over fifty remote campsites, including the Mirabib Campsites. The campsites' remote location poses three management problems: insufficient maintenance, inability to enforce campsite permits, and lack of awareness about campsites in the NNP. When visiting Mirabib, the maintenance problems are clear; trash is scattered around the campsites, the chairs are damaged or missing, and the toilets are unsanitary. The goal of this project was to propose design options, management plans, and marketing strategies for updating the Mirabib Campsites to increase environmentally sustainable tourism in Namibia's Namib-Naukluft Park.

## Methodology

To accomplish this goal, the team set the following objectives:

1. Analyzed potential infrastructure updates to the Mirabib Campsites and the associated material and maintenance costs
2. Analyzed management plans for the Mirabib Campsites and the associated operating costs
3. Determined strategies to attract visitors to the Mirabib Campsites

First, we researched environmental concerns caused by the existing infrastructure and ways to address the concerns through updated infrastructure. Second, we interviewed park maintenance staff to identify current campsite maintenance activities and researched existing campsite management plans to identify costs associated with implementation and continued operation. Third, we benchmarked current marketing strategies used for other campsites in the NNP and identified the unique features of Mirabib.

## Findings

Through evaluation of our research and interview responses, we developed the following findings regarding infrastructure updates, management plans, and marketing strategies:

Finding 1: The Mirabib Campsite infrastructure creates problems associated with environmental impact, maintenance requirements, and visitor comfort.

**Trashcans:** Bottles, bags, and other bits of rubbish are strewn around the campsites and across the surrounding area.

**Tent Areas:** Mapping out the campsites showed that many of the areas designated for placing a tent are not flat.

**Toilets:** The uncleanliness of the toilets discourages visitors from using the designated facilities.

**Signs:** When visitors arrive at the Mirabib Campsites, they have no way of knowing the location or the number of campsites, or where the nearest toilet facility is located.

**Braai Pit:** The braai pits do not limit fire size and are not comfortable for visitor use.

**Layout:** The layout of Mirabib is determined by locations within Mirabib that are shaded by the rocks. The layout of amenities reduces visitor comfort and safety.

**Showers:** From interviews with tour companies, we found that there is a need for showers at Mirabib.

Finding 2: Management plans vary on their monitoring levels and their associated infrastructure requirements.

**Monthly Monitoring:** At campsites with monthly monitoring, fees are collected in an on-site box. The collection box and all infrastructure is unmonitored and it is the visitor's responsibility to pay the proper amount for their visit. The management staff collects fees and maintains campsites monthly.

**Weekly Monitoring:** At campsites with weekly monitoring, fees are also collected in a box on-site with no enforcement by management staff. Similar to monthly monitoring, the collection box and infrastructure are relatively unmonitored, and it is the visitor's responsibility to pay for their visit. The management staff collects fees and maintains campsites weekly.

**Daily Monitoring:** At campsites with daily monitoring, staff collects fees and maintain the campsites daily.

**On-site Monitoring:** At campsites with on-site monitoring, management staff lives on-site. Fees are collected when the visitor checks in for their stay.

Finding 3: Marketing methods for the Mirabib Campsites should be tailored for the following three geographic zones: all international markets, neighboring countries, major cities in Namibia.

**All International Markets:** Approximately 60% of all Namibian holiday tourists plan their trips via internet (MET, 2013). Therefore, the internet is the most effective way to get information to people from all over the world.

**Neighboring Countries:** According to the 2012-2013 MET exit survey, approximately 35% of holiday visitors from neighboring countries plan their trips via magazines and guidebooks. From talking to a tourist at the Mirabib Campsites, we found that Mirabib attracts visitors via popular outdoors magazines such as Go! Magazine, GetAway Magazine, and Africa Geographic.

**Major Cities in Namibia:** We interviewed Blue Crane Safaris and Journeys Namibia, a tour operator and a tour management company, respectively. We found that both companies use brochures to promote various destinations throughout Namibia to in country tourists. Brochures are an affordable yet effective method to distribute information to tourists.

Finding 4: Marketing materials need to highlight Mirabib's unique features: a scenic drive, rock climbing, a self-guided nature trail, remoteness and solitude, sunrise and sunset, and stargazing.

**A Scenic Drive:** Mirabib lies on a 137km loop that encompasses Zebra Pan, Hope Mine, Homeb, Topnaar Villages, Welwitschia Plant Community, Gobabeb Research and Training Centre, and the Mirabib Hill Shelter.

**Rock Climbing:** The Mirabib Campsites have the potential to be a rock climbing attraction for skilled climbers. Installation and use of the rock climbing area can be accomplished in an eco-friendly and safe method.

**A Nature Trail:** Tourists can walk the trail and learn about the unique features of the area, specifically: geology, flora, and fauna.

**Remoteness and Solitude:** The Mirabib Inselberg is remote and each campsite is secluded. When at one campsite, visitors can neither hear nor see anyone at other campsites.

**Sunrise and Sunset:** Visitors can watch the sunrise over the Gamsberg Plateau to the east and the sunset over the red sand dunes in the west.

**Stargazing:** Many stars are visible at the Mirabib Campsites because of the minimal light pollution in the area.

**Finding 5:** If frequent visits to the Mirabib Campsites are required, then the Topnaar People's on-site involvement is limited due to their long distance from the campsites.

There are many community-based campsites in Namibia (Appendix R). These campsites can be managed by the local communities because of the limited distance between the communities and the campsites. Through our research, we found that the nearest Topnaar village is over 30 km from the Mirabib Campsites, much farther than the existing community-based campsites. The distance limits the ability of the Topnaar People's to travel daily to the campsites as required. However, the distance is not a concern if an on-site employee manages the campsites. In addition, the Topnaar People's distance from the Mirabib Campsites does not limit their off-site involvement. To involve the Topnaar people in the Mirabib Campsites, off-site activities must be established.

## Recommendations

Based on our findings, we have identified three main opportunities for improvement at the Mirabib Campsites: infrastructure updates, management plans, and marketing strategies. Here, we provide related recommendations:

**Recommendation 1:** Prioritize infrastructure updates based on environmental concern, benefit to visitor comfort, and cost.

**Trashcans:** Install a cover to the existing trashcans with a sign that educates users about proper trash disposal.

**Showers:** Install a solar shower bag hook area to increase visitor comfort.

**Signs:** Install signs to direct visitors to all seven campsites and necessary amenities.

**Sign Board:** Install an informational sign board to educate visitors about Mirabib.

**Toilet:** Install an eco-friendly toilet that ventilates the waste pit, prevents the entrance of insects, and separates the solid and liquid human waste.

**Leveling:** Add sand with a retaining wall to flatten campsites.

**Layout:** Change amenity layout to improve comfort and safety for visitors.

**Braai Pit:** Install a taller braai pit with fixed grates that limit the maximum fire size.

**Tables:** Install a steel framed concrete table with replaceable concrete chairs to reduce maintenance requirements.

A full design and detailed material costing information for all updates can be found in Appendix Q.



Recommendation 2: Of the four possible monitoring levels, we recommend that the Mirabib Campsites experiment with weekly monitoring and implement an honor system for collecting campsite fees.

**Monitoring:** At the Mirabib Campsites, visitors would pay a fee into a secured payment box, located at the entrance of the campsites. Once per week, the maintenance staff would visit the Mirabib Campsites, withdraw the money from the payment box, and then clean the campsite. This money is used to clean the campsites once per week and improve the infrastructure to enhance the visitor experience. A detailed management plan can be found in Appendix S.

**Fees Collected:** The visitors fees collected must be put towards the upkeep and development of the Mirabib Campsites. Upkeep includes the cost of petrol, salary, and maintenance supplies required. The development includes updates to the campsite infrastructure that enhance the visitor experience while preserving the campsite's sense of natural solitude and remoteness.

Recommendation 3: Create a brochure, print/online publications, and web page to that reach the target audience in Namibia, neighboring countries, and international countries to promote the Mirabib Campsites.

**Brochure:** Distribute a promotional brochure to major cities in Namibia. A same brochure can be found in Appendix O.

**Print / Online Publication:** Publish articles in magazines across South Africa and Botswana. A list of sample magazine and online publication sources can be found in Appendix P.

**Web Page:** Create a web page to reach international tourists who are not in Namibia nor receive subscriptions to travel magazines.

Recommendation 4: To attract visitors to the Mirabib Campsites, promote a scenic drive, rock climbing, self-guided nature trail, remoteness and solitude, sunrises and sunsets, and stargazing in marketing materials, but exclude the Mirabib Hill Shelter and the Welwitschia Plant Community.

The promotable attractions highlight the unique features of Mirabib and their descriptions can be found in Finding 4. However, we determined that the Mirabib Hill Shelter and Welwitschia Plant Community should not be included in marketing materials for the following reasons:

**The Mirabib Hill Shelter:** This archaeological site is an active research area that is not open to the public. Visitors to this site could disrupt the current research by damaging uncatalogued artifacts.

**Welwitschia Plant Community:** The endemic Welwitschia plants are located in an unprotected active research site. Therefore, unmonitored visitors could disrupt research and damage the endemic plant through improper, direct contact

## Authorship

All four team members contributed equally to this project. Throughout the course of the project, different team members contributed to certain aspects of the project. Many portions of the project were completed as a team, or were heavily contributed to by multiple team members. An overview of the specific roles of each member can be found below.

**Katie Candiloro** contributed most heavily as the organizer of the team. She kept the team on track and did many of the small “housekeeping” tasks, including making agendas and taking minutes. She was the one constantly going back to the handbook and to past IQPs to make sure everything was done right. She wrote the abstract, the project conclusion, and the “Principle in Overseas Project Design” section. She edited almost every section and wrote many of the introduction and summary sections. She contributed heavily to the Introduction and executive summary.

**Julian Dano** was the editor for the team. He compiled everything into one document and edited pieces to make them all flow together. He used his expertise as an industrial engineer to compile the budgeted management plan. Julian was the main contact point for communication outside of the team. He also contributed heavily to the infrastructure design and recommendations.

**Jaime Espinola** was the leader on the design process for an improved infrastructure. She completed much of the research needed for this objective, and drafted the methodology, findings, and recommendations for this objective. Jaime did a good amount of editing and challenged other team members to write at a higher level. She also contributed heavily to the ecotourism study. Jaime took many of the pictures seen throughout the report.

**Daniel Thiesse** led the marketing objective. He headed the marketing-related research and designed the marketing deliverables, as well as writing the methodology, findings, and recommendations for this objective. He completed many of the Solidworks™ models that were used throughout the project. Daniel also designed the cover page and formatted the final report.

## Table of Contents

Abstract.....	i
Acknowledgements.....	ii
Executive Summary.....	iii
Methodology.....	iii
Findings.....	iii
Recommendations.....	vi
Authorship.....	viii
List of Figures.....	xi
List of Tables.....	xiii
List of Abbreviations.....	xiv
Chapter 1: Introduction.....	1
Chapter 2: Background.....	3
2.1: The Unique Characteristics of the Mirabib Campsites.....	3
2.2: The Negative Side Effects of Tourism.....	6
2.3: Ecotourism as a Solution.....	7
2.5: Summary.....	9
Chapter 3: Methodology.....	10
3.1: Analyze potential infrastructure updates to the Mirabib Campsites and the associated material and maintenance costs.....	10
3.2: Analyze management plans for the Mirabib Campsites and the associated operating costs...	12
3.3: Determine strategies to attract visitors to the Mirabib Campsites.....	13
3.4: Summary.....	14
Chapter 4: Results and Findings.....	15
4.1: Infrastructure Updates.....	15
4.2: Management Plans.....	28
4.3: Marketing Strategies.....	30
4.4: Summary.....	33
Chapter 5: Conclusions and Recommendations.....	35
5.1: Conclusions.....	35
5.2: Infrastructure Updates.....	35
5.3: Management Plans.....	42
5.4: Marketing Strategies.....	42
5.5: Future Studies.....	43
5.6: Principles in Overseas Project Design.....	44

---

Chapter 6: Bibliography .....	46
Appendix A: National Policy on Tourism for Namibia, Principles of Policy (MET, 2008) .....	51
Appendix B: Interview Protocol for Tourists.....	52
Appendix C: Interview protocol for Key Experts at Gobabeb .....	53
Appendix D: Interview Protocol for Management Staff at the Ministry of Environment and Tourism.....	54
Appendix E: Interview Protocol for Dominic du Raan: Director of Journeys Namibia .....	55
Appendix F: Interview Protocol for Sem Shikongo, Direction of Tourism, Ministry of Environment and Tourism .....	56
Appendix G: Interview Protocol for Chris Neakre, Topnaar Traditional Authority Liaison.....	57
Appendix H: Interview Protocol for Titus Shuuya, a Welwitschia Researcher .....	58
Appendix I: Interview Protocol for Derek Jacobs, Director of Blue Crane Safaris .....	59
Appendix J: Interview Protocol for Arnold Uwukhaeb, Acting Warden of the Ganab Station .....	60
Appendix K: Email Transcript with Mr. Johan LeRoux .....	61
Appendix L: Email Transcript from Nina Martiz .....	62
Appendix M: Site Mapping .....	65
Campsite 1 .....	65
Campsite 2 .....	67
Campsite 3 .....	69
Campsite 4 .....	71
Campsite 5 .....	73
Campsite 6 .....	75
Campsite 7 .....	77
Appendix N: Sun/Shade Assessment .....	79
Appendix O: Marketing Brochure Template .....	83
Appendix P: Printed Publication Details .....	85
Appendix Q: Infrastructure Benchmarking .....	86
Appendix R: Detailed Infrastructure Information .....	97
Appendix S: Community Based Campsites in Namibia .....	138
Appendix T: Detailed Management Plan .....	141

## List of Figures

Figure 1: View of the Inselberg from the Desert Plains .....	3
Figure 2: Map of the Mirabib Campsites .....	4
Figure 3: Trash Spread Around the Campsites .....	16
Figure 4: Faded Sign Located in the NNP .....	18
Figure 5: Small Shade Structure .....	21
Figure 6: Braai Pit Located on Steep Drop Off .....	22
Figure 7: Braai Pit with Crack in Concrete Base .....	24
Figure 8: Table Missing Three of Six Chairs.....	25
Figure 9: Driving Loop in the Central NNP .....	32
Figure 10: Site map of campsite 1.....	65
Figure 11: An incline map of campsite 1.....	66
Figure 12: Site map of campsite 2.....	67
Figure 13: An incline map of campsite 2.....	68
Figure 14: A site map of campsite 3.....	69
Figure 15: An incline map of campsite 3.....	70
Figure 16: A site map of campsite 4.....	71
Figure 17: An incline map of campsite 4.....	72
Figure 18: A site map of campsite 5.....	73
Figure 19: An incline map of campsite 5.....	74
Figure 20: A site map of campsite 6.....	75
Figure 21: An incline map of campsite 6.....	76
Figure 22: A site map of campsite 7.....	77
Figure 23: An incline map of campsite 7.....	78
Figure 24: Sun/Shade Assessment for Campsite 1 .....	79
Figure 25: Sun/Shade Assessment for Campsite 2 .....	80
Figure 26: Sun/Shade Assessment for Campsite 3 .....	80
Figure 27: Sun/Shade Assessment for Campsite 4 .....	81
Figure 28: Sun/Shade Assessment for Campsite 5 .....	81
Figure 29: Sun/Shade Assessment for Campsite 6 .....	82
Figure 30: Sun/Shade Assessment for Campsite 7 .....	82
Figure 31: Marketing Brochure Template Side A.....	83
Figure 32: Marketing Brochure Template Side B.....	84
Figure 33: One-Piece Reinforced Concrete Table Design .....	86
Figure 34: Reinforced Steel Table with Individual Seats.....	87
Figure 35: Table With Steel Frame Embedded in Concrete.....	87
Figure 36: Round Reinforced Concrete Table .....	88
Figure 37: A Pit Toilet Structure.....	89
Figure 38: The Otji-Toilet in Namibia .....	90
Figure 39: The Eco-Friendly Toilet .....	90
Figure 40: A Large Braai Pit .....	91
Figure 41: A Low Profile Braai Pit.....	92
Figure 42: Simple Trashcan Lid .....	92
Figure 43: Trashcan with a Smaller Opening .....	93
Figure 44: Leveled Gobabeb Campsite .....	94
Figure 45: A Basic Donkey Shower.....	95

Figure 46: A Complex Donkey Shower .....	95
Figure 47: A Solar Shower Bag .....	96
Figure 48: Proposed Trashcan Lid .....	98
Figure 49: Educational Sign to Place on Trashcans .....	99
Figure 50: Shower Location within Natural Rock Structures .....	100
Figure 51: Signpost at the entrance to the campsites. ....	103
Figure 52: Elevated Wooden Sign Structure .....	104
Figure 53: Sign Indicating Campsite Number.....	105
Figure 54: Toilet Sign.....	105
Figure 55: Location of Campsite Number Sign on Campsite 1 .....	106
Figure 56: Location of Toilet Sign on Campsite 1.....	106
Figure 57: Location of Campsite Number Sign on Campsite 2 .....	107
Figure 58: Location of Toilet Sign on Campsite 2.....	107
Figure 59: Location of Campsite Number Sign on Campsite 3 .....	108
Figure 60: Location of Toilet Sign on Campsite 3.....	108
Figure 61: Location of Campsite Number Sign on Campsite 4 .....	109
Figure 62: Location of Campsite Number Sign on Campsite 5 .....	110
Figure 63: Location of Toilet Sign on Campsite 5.....	110
Figure 64: Location of Campsite Number Sign on Campsite 6 .....	111
Figure 65: Location of Toilet Sign on Campsite 6.....	111
Figure 66: Location of Campsite Number Sign on Campsite 7 .....	112
Figure 67: Location of Toilet Sign on Campsite 7.....	112
Figure 68: Location of Sign at Main Entrance .....	113
Figure 69: Sign Board .....	114
Figure 70: View of Closed in Area Toilet Facility.....	116
Figure 71: View of Vertical Ventilation Pipe from the Pit into the Outside Air .....	117
Figure 72: Insect Mesh at the Top of the Ventilation Pipe .....	117
Figure 73: View of Liquid Waste Drainage Pipe .....	118
Figure 74: View of Liquid Drain Pipe Removing Waste Prior to the Pit .....	119
Figure 75: Design for Flattening Campsites, Including a Retaining Wall .....	121
Figure 76: Existing Layout of Campsite 1 .....	123
Figure 77: Proposed Layout of Campsite 1 .....	123
Figure 78: Existing Layout of Campsite 2 .....	124
Figure 79: Proposed Layout of Campsite 2 .....	124
Figure 80: Existing Layout for Campsite 3.....	125
Figure 81: Proposed Layout for Campsite 3.....	125
Figure 82: Existing Layout for Campsite 4.....	126
Figure 83: Proposed Layout for Campsite 4.....	126
Figure 84: Existing Layout for Campsite 5.....	127
Figure 85: Proposed Layout for Campsite 5.....	127
Figure 86: Existing Layout for Campsite 6.....	128
Figure 87: Proposed Layout for Campsite 6.....	128
Figure 88: Existing Layout for Campsite 7.....	129
Figure 89: Proposed Layout for Campsite 7.....	129
Figure 90: Map of Location of Toilets .....	130
Figure 91: Braai Pit with Attached Grate .....	131
Figure 92: Rotating Grate to Allow Wood to be Placed Inside Braai Pit.....	132
Figure 93: View of Small Area to Place Wood to Limit Fire Size .....	133

Figure 94: Full Table Design .....	135
Figure 95: Steel Table Frame .....	135
Figure 96: View of Attachment of Steel Frame to Table and Chairs.....	136
Figure 97: Attachment of Chair and Table to Steel Frame .....	137
Figure 98: Expense Assumptions for Managing the Mirabib Campsites .....	143
Figure 99: Revenue Assumptions for Managing the Mirabib Campsites.....	143
Figure 100: Projected Profit for a 3-year Time Period .....	144

## List of Tables

Table 1: Table Detailing Paper and Online Publications .....	85
Table 2: Advantages and Disadvantages of Different Table Designs.....	86
Table 3: Advantages and Disadvantages of Different Toilet Designs .....	88
Table 4: Advantages and Disadvantages of Different Braai Pit Designs .....	90
Table 5: Advantages and Disadvantages of Different Trashcan Designs .....	92
Table 6: Advantages and Disadvantages of Flattening Campsites and leaving them as they are .....	93
Table 7: Advantages and Disadvantages of Different Shower Designs .....	94
Table 8: Costing Information for Trashcans.....	97
Table 9: Costing for Showers .....	99
Table 10: Costing for Toilet Signs.....	102
Table 11: Costing for Campsite Signs.....	102
Table 12: Costing for Entrance Sign .....	102
Table 13: Costing for Education Board .....	114
Table 14: Costing for Toilets .....	115
Table 15: Costing for Flattening Campsites .....	120
Table 16: Costing for Braai Pits .....	131
Table 17: Costing for Tables.....	134

## List of Abbreviations

*Throughout this report, a few abbreviations are used. They are outlined below.*

NNP -- Namib-Naukluft Park

MET -- Ministry of Environment and Tourism

Gobabeb – Gobabeb Research and Training Centre

WPI – Worcester Polytechnic Institute

CAD – Computed Assisted Drafting (in this project, Solidworks™ was used)

NGO – Non-Governmental Organization

! – When used in a word, this represents a click in the !nama language

// -- When used in a word, this represents a click in the Khoisan language



## Chapter 1: Introduction

Approximately eight billion people visit national parks each year to observe the natural and untouched beauty (Balmford, 2015; Lema, 2009). To preserve the national parks, infrastructure must be limited. According to the Ministry of Environment and Tourism (MET), “developments will only be supported if they...do not detract from the natural attractions of the area,” (National Policy on Tourism for Namibia, 2008). However, national parks cannot expect visitors to pay high fees to stay at campsites with limited infrastructure. Profits are used to maintain the campsites, and so irregular and limited campsite maintenance leads to environmental damage. In rural Kenya, improper maintenance of human waste facilities led to serious health and environmental concerns, including contaminated water and an outbreak of diarrhea, a direct result of poor maintenance of overly simplified amenities. (Henry, 2006).

Along Namibia’s Atlantic coast lies one of the oldest deserts on earth, the Namib Desert. This 1,570 kilometer stretch of arid environment is home to a variety of plants and animals, many of which are endemic (Thuiller, 2006). Every year, tourists visit the Namib Desert to observe its unique geology and biodiversity. Unfortunately, human activity threatens the Namib Desert’s unique ecosystem. To help prevent environmental destruction and to allow for the tourism industry to expand, the Ministry of Environment and Tourism (MET) established protected regions of the Namib Desert including the Namib-Naukluft Park (NNP) (Namibia Tourism Board, 2015).

The Namib-Naukluft Park (NNP), the largest protected area in Namibia, contains over fifty remote campsites. The campsites’ remote location poses three management problems: insufficient maintenance, inability to enforce campsite permits, and lack of awareness about the existence of campsites in the NNP. First, campsites are maintained only once a month by the Ministry of Environment and Tourism (A. Uwukhaeb, personal communication, 23 April 2015). Second, the large size of the park makes it difficult for park maintenance staff to enforce campsite permits. Campers are able to stay in the park without purchasing a campsite permit. Third, lack of publicity for Mirabib limits the number of paying visitors. Because of these three constraints, MET struggles to carry out routine maintenance.

Mirabib, a remote and secluded campsite in the NNP gravel plains, is limited by the lack of infrastructure and logistical constraints typical within the NNP. When visiting Mirabib, the challenges presented by maintenance are clear; trash is scattered around the campsites, the chairs are damaged or missing, and the toilets are unsanitary. Mirabib’s solitude and unique natural features are not reaching the potential audience. The few visitors who do reach Mirabib are unaware of the

local plants and animals, and see the desert as a place that contains little to no life. For Mirabib to reach its full potential as a tourist attraction, the infrastructure must be updated to reduce environmental damage, and Mirabib must be marketed to attract more visitors.

The goal of this project was to propose design options, management plans, and marketing strategies for updating the Mirabib Campsites to increase environmentally sustainable tourism in Namibia's Namib-Naukluft Park. To accomplish this goal, the team set the following objectives:

1. Analyzed potential infrastructure updates to the Mirabib Campsites and the associated material and maintenance costs
2. Analyzed management plans for the Mirabib Campsites and the associated operating costs
3. Determined strategies to attract visitors to the Mirabib Campsites

With this project we hoped to provide recommendations to design an environmentally sustainable tourist destination at the Mirabib Campsites, and create a model for other campsites throughout Namib-Naukluft Park.

## Chapter 2: Background

The Mirabib inselberg is a unique natural attraction in Namibia's Namib-Naukluft Park (NNP). While this is a great place to visit, many places in the world have seen an increase in tourism produce a negative effect on the local environment. The idea of ecotourism creates a framework to prevent these negative effects, but is a continually changing concept. Other places in the world have created infrastructure to address some of the concepts of ecotourism. These designs are not all perfect for Mirabib, but many have ideas that can be applied to improved infrastructure at Mirabib. This chapter examines three topics:

1. The unique characteristics of the Mirabib Campsites
2. The negative side effects of tourism
3. Ecotourism as a tool for sustainable tourism

### 2.1: The Unique Characteristics of the Mirabib Campsites

The Mirabib Inselberg (Figure 1), a large granite outcrop located in the Namib-Naukluft Park, is home to the Mirabib Campsites (Eckardt, 2013). There are seven sites, each providing visitors with a table, a braai pit, and a toilet, which are accessible with a 2X4 vehicle by gravel roads that require a park entry permit from the Ministry of Environment and Tourism (MET).



*Figure 1: View of the Inselberg from the Desert Plains*

As shown in Figure 2, not only is Mirabib remote, but while camping, visitors cannot hear or see the visitors at the other campsites. Individual campsites are nestled between the rock structures,

providing isolation and natural shade. These unique features create a comfortable camping experience.



Figure 2: Map of the Mirabib Campsites

#### 2.1.1: Arid Climate of the Namib-Naukluft Park

The NNP contains some of the most arid lands in Africa (MET, 2013). Although the Namib is considered one of the driest deserts in the world, the rainfall within the NNP varies by location. According to the Gobabeb Research and Training Centre (Gobabeb), an internationally recognized center for arid environment research near Mirabib, the central NNP, where the Mirabib campsites are located, averages 20-50mm of annual rainfall, primarily during the rainy season of January through March. Fog occurs approximately 40 days of the year (MET, 2013). Although the NNP has high evaporation rates and low rainfall (MET, 2013), the moisture from the fog is a water source for plants and animals and is a vital contributor to the ecosystem of the park (Eckardt, 2013). Temperatures range from about 7-32° Celsius (45-90° Fahrenheit) and winds blow through the area, mainly from the southwest direction with occasional strong easterlies (MET, 2013).

#### 2.1.2: Inselbergs

The Mirabib Campsites are situated around a remote, granite inselberg in the central Namib Desert. Inselbergs are “remnants of erosion processes forming isolated mountains which can range in elevation from few to several hundred meters” (Burke, 2003). Found widely throughout the central Namib Desert, granite inselbergs date back to 470 to 650 million years ago (Goudie & Viles, 2015). The unique features of inselbergs provide a convenient shelter for many microhabitats to

flourish, and tourists frequently travel to the central Namib Desert to observe these habitats and seek shelter in the shade created by the rock structures.

### 2.1.3: Special Flora and Fauna of the Namib-Naukluft Park

Despite the harsh living conditions, the Namib Desert environment is home to many species of plants and animals. Approximately 3,500 different species of plants live in the NNP (WWF, 2015). Geophytes, perennial herbs, and trees can all be found scattered along the landscape (Thuiller, 2006). Two particularly interesting plants exist in the Namib: the *Welwitschia Mirabilis* and the !Nara. The *Welwitschia Mirabilis* is a shrub-like plant that has only two leaves; they continually grow for its entire life span, which can be over 1,000 years (WWF, 2015). These leaves can grow to incredible shapes, forming a plant that is up to 1.5 meters tall. The !Nara plant is a type of melon that can be found only in Namibia. It has no leaves, but uses its spiked vines to perform photosynthesis. It has edible seeds, and is the main food source for the Topnaar people (Masaaki, 2005).

The Namib Desert is also home to several endemic animal species (WWF, 2015). Endemic species are sub-species that can only be found in their respective region or country (Wassenaar, 2013). A variety of mammals, reptiles, beetles, and birds live around Mirabib. Zebra, oryx, springbok, ostriches, rabbits, rock dassies, and rodents, as well as five endemic reptile species and six endemic bird species inhabit the Mirabib region (MET, 2013; WWF, 2015). Bird populations commonly stay closer to the coast near ample water and do not live around Mirabib. However, there is a large crow population living in the region (WWF, 2015). The Namib Desert is also home to over 200 different species of beetles that live within the desert sand (Animal Planet, 2015). The Namibian Beetle, commonly found at Mirabib, survives by consuming water from fog. The beetle tilts its body at a 45° angle and due to the microscopic bumps on its back, water droplets collect and slide down channels into its mouth (Hamilton, 2003). Despite the harsh climate of the Namib Desert, Mirabib visitors may see special forms of wildlife.

### 2.1.4: The Cultural History of the Mirabib Area

Within walking distance of the Mirabib Campsites is the Mirabib Hill Shelter. This location, among many others in the NNP, has sheltered ancient nomadic tribes in the Central Namib Desert. The tribes were primarily hunter-gatherers, indicated by the types of metal and organic artifacts found at the site (Sandelowsky, 1974). The most recent occupants at Mirabib lived in conditions similar to the current condition of the area (Sandelowsky, 1974). Due to the arid desert environment, water was only available in certain regions, forcing the ancient tribes to follow a nomadic lifestyle. After the rainy season, the Mirabib Hill Shelter retained fresh water in the granite

hollows, giving the nomadic people a water source (Sandelowsky, 1974). Although there are no longer nomadic people inhabiting the Mirabib Hill Shelter, the shelter is now an active research site.

Along the Kuiseb River are small villages of people known as the Topnaar. Homeb, the closest Topnaar settlement, is 30 km from the Mirabib Campsites. The Topnaar people originate from the !Nama people who are primarily known for their “click” language. For survival, they herd cattle, garden, and gather the Inara melon (Van Damme, 1922; Masaaki, 2005). Although the Topnaar People were traditionally nomadic, boreholes along the Kuiseb River now eliminate the need to migrate. The Topnaar People are currently not involved in the operations of the Mirabib Campsites.

## 2.2: The Negative Side Effects of Tourism

People travel across the world to see notable natural attractions; however, few tourists consider their negative impacts on the destination. Tourism has the ability to generate income for the local economy, but also has the potential to harm the environment and local culture.

### 2.2.1: Tourism Damaging the Local Environment and Culture

Case studies from Brazil, India, and Namibia demonstrate how tourism can harm the environment and local culture. The Brazilian coast plays host to an extensive series of coral reefs and fish populations. This diverse ecosystem is an important part of marine life, but has been greatly affected by tourist activities. Human interaction has created long-lasting damage to the reefs known as reef trampling. According to V. C. Sarmiento, researcher in the department of Zoology at Brazil’s Federal University of Pernambuco, “The major threats on the Brazilian reefs appear to be related to human activities, such as uncontrolled urban development and rapidly growing, unplanned tourism activities” (Sarmiento, 2012). Not only are the reefs damaged, but future visitors are unable to enjoy the same natural beauty. While coral reefs are popular tourism destinations, “the impact of trampling induced by recreational activities clearly deserves attention in coastal management plans” (Sarmiento, 2012). Like many other destinations, coral reefs are an example of the environment damage caused by tourist activities.

India’s Parimbikulam Wildlife Reserve also shows the negative impacts of tourism. Parimbikulam was founded to save the land’s unique topography while creating a tourism destination. Unfortunately, the local tribe suffered due to land restrictions and exclusion from tourism profits (Durbach, 2007). Parimbikulam may be great for the ecosystem and tourists, but it has displaced the local people.

Etosha National Park in Namibia has also displaced the local people. The Etosha land was once home to the Hai//om People, but in 1954, they were removed from the land because they did not “fit-in” with the South African government’s plan to create a national park (Odendaal, 2007).

They were promised government aid, but have received almost nothing. The Hai//om People now live in high levels of poverty, and a lack of leadership in the tribe makes standing up to the government almost impossible. The Herero people were also removed in 1920. They lost much of their historical land, and receive no benefits from the park (Hoole, 2008). Etosha is great as a conservatory and tourist destination, but has devastated the native people.

### 2.2.2: Damage Caused by Basic Amenities

Basic amenities, such as trashcans and long drop toilets, can harm the environment more than advanced facilities. First, campsites often use recycled oil drums as trashcans, but their simple design can cause problems (Williamson, 2013). Open trashcans allow animals to access trash and spread it around the campsites. When the wind blows, the trash is further spread around the area. Second, long-drop toilets can cause damage to the environment as well. While a hole in the ground may seem simple and harmless, seepage of waste can become harmful (Australian Government Department of Health, 2010). A long drop toilet may be better than open defecation, but it is not ideal.

## 2.3: Ecotourism as a Solution

Ecotourism was originally defined by Ceballos-Lascurain who focused on the site itself and how tourists viewed the surrounding area. At the present time, The International Ecotourism Society (TIES), identifies ecotourism as “responsible travel to natural areas that conserves the environment, sustains the well-being of the local people, and involves interpretation and education” (TIES, 2015).

### 2.3.1: What is Ecotourism?

Based on TIES’s definition of ecotourism, a set of metrics was identified for evaluating an ecotourism destination. Additionally, the African Wildlife Association’s idea that ecotourism is “travel with ethic” (African Wildlife Association, 2002) was taken into account. The list below establishes our expectations for an ecotourism destination with respect to this project:

1. Minimizes negative impacts on the environment and the local people
2. Educates visitors about the environment and the local people
3. Puts a portion of profits back into the conservation of the local area
4. Designs and recommends low impact facilities for visitor

**Minimizes negative impacts on the environment and the local people:** The primary goal of ecotourism is to limit the negative affect visitors can have on area. Proper disposal of garbage and human waste is key to limiting negative impacts. This metric helps to ensure that pollution and environmental degradation is kept to a minimum at tourist destinations. It is also important that visitors do not harm the culture of the local people. In order to so, the local people must receive a

portion of any positive effect of the ecotourism, while also not receiving the negative impacts created by the visitors (Scheyvens, 245).

**Educates visitors about the environment and the local people:** Education about the environment can help to decrease the impact that visitors have on the area. It is important that each visitor understand the specific environment they are in, and how their actions could be harmful. Education about the local culture can help connect a visitor to the site. Through direct immersion and an understanding of culture, visitors can feel a connection to their hosts that lasts long beyond the scope of their visit (Lindsay, 2003).

**Puts a portion of profits back into the conservation of the local area:** The goal of this metric is to ensure that the profits are not given to imported business owners, but instead are reinvested into the local area. If funds are given to conservation, the money can help to protect the environment or be used to raise awareness about conservation.

**Designs and recommends low impact facilities for visitors:** The success of ecotourism is dependent on infrastructure that both satisfies the visitor and works in harmony with the environment. It is important that no infrastructure is built that will damage the environment, and existing infrastructure should be updated when possible.

### 2.3.2: Ecotourism as a Conservation Tool

Ecotourism has the potential to “connect conservation, communities, and sustainable travel” (TIES, 2015). Ecotourism can help to foster a mutually beneficial relationship between the local people, the environment, and the tourists visiting the area (Ross & Wall, 1999). For example, ecotourism can increase conservation awareness and establish conservation practices among tourists.

The Mon Repos conservation park, located along the northeastern coast of mainland Australia, is a hub for visitors to learn about sea turtle conservation (Tisdell & Wilson, 2000). At the park, sea turtle viewings attract many visitors. Once the tour guides have given their permission, visitors can approach and touch the sea turtles. In Australia, the goals were to “(1) help satisfy the natural curiosity of individuals; (2) enhance their environmental awareness and (3) strengthen the pro-conservation values of visitors, thereby increasing the likelihood that they will take positive future action to protect nature” (Tisdell & Wilson, 2000). From Mon Repos Conservation Park’s visitor survey results, it was clear that physical contact with nature was able to reinforce the visitors’ environmental awareness and empathy for the sea turtles (Tisdell & Wilson, 2000). Because the visitors were considerate of the cause, they were more willing to implement conservation methods they learned, such as reporting injured turtles or donating money to the conservation effort.



Vietnam's Con Dao National Park uses a self-guided education approach. This park, a tropical island located south of mainland Vietnam, is home to both natural and historical attractions. The natural attractions include diverse species of plants and animals along with the largest diversity of corals in all of Vietnam (Ringer & Robinson, 1999). The historical attractions include many abandoned prisons scattered throughout the island. Visitors are urged to hike, bike, swim, scuba dive, and enjoy the scenic views. The park has created maps, brochures, and posters that visitors use in order to learn while they partake in activities throughout the island (Ringer & Robinson, 1999). This gives visitors the opportunity to experience the Park on their own while still learning about the environment and culture.

These case studies show that ecotourism can raise awareness and motivate visitors to contribute to the conservation effort. If the awareness is built, people will be more empathetic towards the mission of that particular destination. In our project at the Mirabib Campsites, we need to ensure the visitors are gaining an experience that increases their environmental awareness and provides them with methods for environmental conservation.

### 2.2.3: Namibian Policy to Increase Sustainable Tourism

As the tourism industry has grown in Namibia, government regulations have been put in place to maximize foreign income and keep the industry internationally competitive. In December 2008, the Namibian Ministry of Environment and Tourism (MET) introduced the *National Policy on Tourism for Namibia*, a strategic plan to increase tourism in a way that benefits the economy. In particular, it targets sustained economic growth, employment creation, reduced inequalities in income and gender, reduced poverty, and the promotion of economic empowerment. This policy has ten basic principles that the tourism industry must uphold which can be seen in Appendix A. In the context of this project, the most important part of this policy is that all tourism efforts need to be designed to be sustainable, profitable, and environmentally friendly.

## 2.5: Summary

Mirabib is a unique place for its remoteness and natural environment. Tourism at Mirabib has the potential to be environmentally sustainable and still comfortable for visitors. Many examples of surges of new visitors negatively impacting the natural site that they intended to see can be found around the world and in Namibia; however ecotourism sets a framework for creating environmentally sustainable tourism destinations. With proper amenities Mirabib has the potential to be an environmentally sustainable tourism destination in Namibia's NNP.

## Chapter 3: Methodology

The goal of this project was to propose design options, management plans, and marketing strategies for updating the Mirabib Campsites to increase environmentally sustainable tourism in Namibia's Namib-Naukluft Park. To accomplish this goal, the team set the following objectives:

1. Analyzed potential infrastructure updates to the Mirabib Campsites and the associated material and maintenance costs
2. Analyzed management plans for the Mirabib Campsites and the associated operating costs
3. Determined strategies to attract visitors to the Mirabib Campsites

### 3.1: Analyze potential infrastructure updates to the Mirabib Campsites and the associated material and maintenance costs

The first **knowledge sought** was the infrastructure needs of major stakeholders including the park maintenance staff, campsite visitors, the local desert environment, and campsite operators. Understanding the major stakeholders' needs helped us identify appropriate infrastructure updates for the Mirabib Campsites. Second, we sought information on existing infrastructure that is used in similar applications. Third, we sought to find the material costs associated with installing and maintaining the proposed infrastructure. This knowledge made our recommended infrastructure updates executable.

Our **methods** for obtaining this knowledge included:

1. Conduct interviews with major stakeholders
2. Research environmental concerns caused by existing infrastructure at Mirabib
3. Benchmark existing campsite infrastructures in desert environments
4. Research costs associated with maintaining the new infrastructure

First, we conducted interviews with major stakeholders. For park maintenance staffs' needs, we interviewed Manie LeRoux and Riaan Solomon, the Control Wardens for NNP, and an employee at the NNP maintenance station in Ganab, who are responsible for cleaning and maintaining the Mirabib Campsites (Appendices D and J). For visitor needs, we interviewed Dominic Du Raan, the director at Journeys Namibia, and Derek Jacobs, the Director of Blue Crane Safaris. We also received feedback from two previous visitors to the Mirabib Campsites through personal communications and an on-site interview. For campsite operator's needs, we interviewed Sem Shikongo, the Director of Tourism at MET (Appendix F). Additionally, we interviewed Gillian Maggs-Kölling, the Executive Director of Gobabeb Research and Training Centre and Rodney Amster, special advisor to Gobabeb (Appendix C). We used these responses to develop a needs assessment for major stakeholders.

Second, we researched environmental concerns associated with the existing infrastructure at the Mirabib Campsites. We obtained this information by interviewing park maintenance staff,

observing trash at the Mirabib Campsites, and performed web-based research for environmental concerns associated with the existing toilet facilities.

Third, we observed existing infrastructure designs at three campsites in the NNP: Aruvlei, Homeb, and Mirabib. We also stayed overnight at the Mirabib Campsites to identify improvement opportunities through firsthand experience. After performing a sun/shade assessment and analyzing the incline on each campsite, we determined the campsite's comfort level for visitors. We then researched product websites to identify infrastructure that could be used in part or as a whole at the Mirabib Campsites. Through this research, we identified existing infrastructure solutions that can be tailored to the Mirabib Campsites.

Fourth, we identified costs associated with implementing and maintaining the updated infrastructure. We researched material costs through market price research on the constituents of our recommended infrastructure plans and contacted companies to obtain price quotes on materials.

These methods were **justified** because they allowed us to examine many aspects of the problem before developing a solution. Researcher biases can lead to solutions that are inappropriate for the specific application. We combated these biases by collecting feedback from major stakeholders in the first step of this objective. We used this feedback to develop design specifications for infrastructure analysis prior to the brainstorming phase. This helped ensure that our recommended designs suited all major stakeholders' needs and the Mirabib Campsites context. In addition, our interviews were justified because we gathered information directly from the park maintenance staff who maintain the Mirabib Campsites. These workers have direct knowledge and experience with the maintenance concerns and the replacement costs for broken infrastructure. Through many interviews, all major stakeholders gave us insight into the development and execution of our infrastructure update plan.

Our **analysis** consisted of creating design specifications for acceptable infrastructure designs. The design specifications included not only the physical specifications of the infrastructure, but layout specifications as well. The specifications were created to ensure stakeholders' needs were met.

We faced three **limitations** when completing this objective. First, we needed an accurate representation of all major stakeholders. Although we developed an extended list of major stakeholders, it is always possible that an unforeseen stakeholder may be excluded. Second, we were limited to the number of tourists we could directly contact. Throughout all of our trips to the

Mirabib Campsites, there was only one visitor there to interview since this was not the peak tourist season. As an alternative, we interviewed private tour operators to obtain an understanding of what their clients look for in a trip to the Namib-Naukluft Park. Third, we faced several limitations in identifying accurate costs associated with installing and maintaining infrastructure updates. There are also variable costs associated with picking up damaged amenities and dropping them off at disposal facilities. We kept these variable costs in mind by emphasizing that budgeted management plan is only an estimate of the actual costs.

### 3.2: Analyze management plans for the Mirabib Campsites and the associated operating costs

The **knowledge sought** in this objective was a plan and related costs for managing the Mirabib Campsites. The knowledge included infrastructure material costs, maintenance costs, and advantages and disadvantages of various management plans. This information was used to prioritize infrastructure updates and recommend a management plan for the Mirabib Campsites.

Our **methods** for obtaining this knowledge included:

1. Interview park maintenance staff
2. Research existing campsite management plans
3. Identify operational costs for managing the campsites

First, we interviewed park maintenance staff (Appendix D and J) to identify the routine activities required to maintain each campsite. Activities included trash disposal, raking, and cleaning out braai pits. Second, we performed web-based research on management plans for managing desert campsites. Our search criteria included remote desert campsites in Namibia and the US. Third, from interviewing Peter Buechler, the marketing and management expert at Gobabeb, we identified the costs for managing the campsites including maintenance supplies, petrol, marketing, and additional fees.

This method was **justified** because we researched management plans for remote, desert campsites. Many campsites around the world have convenient access to basic utilities. However, the Mirabib Campsites have no electricity because they are over 150km from Walvis Bay, the nearest major city. There is also no running water. Therefore, our web-based research focused on campsites that are self-sufficient.

Our **analysis** compared the operational costs to various visitor levels at the Mirabib Campsites. Next, we determined the required number of visitors and cost per booking to produce a positive return on investment in a 1-year, 2-year, and 3-year time period. This information also helped us prioritize infrastructure updates based on cost and recommend a management plan.

We faced several **limitations** when completing this objective. The number of visitors at the Mirabib Campsites is unknown which limits the accuracy of predicting the estimated revenue generated from the campsites. In order to justify updates, there has to be some return on investment, but this is difficult to assess without an accurate estimation of the number of visitors. As an alternative, we identified the expenses portion of a management plan. We compared this information to various visitor levels, allowing management to utilize this information and make an informed decision based on the current visitor levels.

### 3.3: Determine strategies to attract visitors to the Mirabib Campsites

The **knowledge sought** in this objective was a marketing strategy to effectively promote the Mirabib Campsites. We needed to discover two components for the marketing strategy: method and content. We used this information to develop a proper marketing strategy that reaches the target audience.

Our **methods** for obtaining this knowledge included:

1. Interview tourism professionals to benchmark existing marketing strategies for campsites in Namibia
2. Visit the Mirabib Campsites
3. Interview tourists at the campsites

First, we interviewed Journeys Namibia, a tour management company, and Blue Crane, a tour operator. From these interviews we found existing marketing materials used by other campsites in Namibia and identified types of content that successful campsites highlight in their promotional materials. We also identified the types of attractions that people look for when booking a campsite. Second, we visited the Mirabib Campsites to identify potential visitor attractions. We sought attractions that highlighted Mirabib's unique features and promoted Mirabib as a place to camp for multiple nights. Third, we conversed with a Mirabib tourist to discover their motivations for choosing the Mirabib Campsites. We asked how the visitors found out about the Mirabib Campsites, which gave us insight into Mirabib's current marketing exposure. Interviewing tourists also helped understand the characteristics that visitors look for when choosing a campsite destination.

These methods were **justified** because direct conversations with the visitors at the Mirabib Campsites helped us to identify existing, effective marketing strategies. By gathering data from people who have experienced Mirabib we collected reliable data, and create a medium that highlighted features current visitors find appealing about the Mirabib area.

To **analyze** the gathered information, we performed two tasks. First, we used our interview responses to identify the geographic locations of the target audience, which helped us determine marketing methods to effectively reach visitors from those locations. Second, we used our interview

responses to develop a visitor persona for the Mirabib Campsites. This information helped us identify the types of attractions that appeal to these visitors. These attractions were used as content for the marketing methods. After this analysis, we combined method and content to develop a proper marketing strategy for the Mirabib Campsites.

We faced several **limitations** when completing this objective. First, we were limited by the available tourism statistics for the NNP. The number of visitors and their reasons for choosing the Mirabib Campsites were unknown because there were no visitor statistics for the Mirabib Campsites. We countered this by conversing with visitors at the Mirabib Campsites and determined the qualities of the target audience. Second, we found it difficult at times to interview visitors because this study was conducted during a low peak tourist season. Although we developed a tentative target audience after interviewing two visitors at the Mirabib Campsites, further interviews must be conducted for a sufficient population representation.

### 3.4: Summary

We obtained knowledge regarding three major aspects of the Mirabib Campsites: infrastructure, management, and promotion. It was important to identify appropriate infrastructure solutions that meets all major stakeholders' needs and can be logistically and economically feasible for campsite management. Our findings are presented in Chapter 4.

## Chapter 4: Results and Findings

This chapter presents our results and findings, and is divided into three sections based on each research objective:

1. Infrastructure Updates: current infrastructure at Mirabib, problems associated with this infrastructure, needs of major stakeholders, and infrastructure products to be used as reference for updating amenities
2. Management Plans: required activities for campsite management, characteristics of remote campsite management plans, and associated operational costs
3. Marketing Strategies: type of visitors at Mirabib, current attractions in the park, and methods to increase visitor interest in staying in the park.

### 4.1: Infrastructure Updates

Finding 1: The Mirabib Campsite infrastructure creates problems associated with environmental impact, maintenance requirements, and visitor comfort.

We identified problems with the following infrastructure components:

1. Trashcans
2. Showers
3. Signs
4. Toilets
5. Leveling
6. Layout
7. Braai Pit
8. Table

For each infrastructure component, we detailed the concerns associated with environmental impact, required maintenance, and visitor comfort. We also included the design specifications established to ensure the infrastructure meets all major stakeholders' needs.

#### *Trashcans*

**Currently, MET cannot effectively manage the trash removal at the Mirabib Campsites.**

**Evidence:** Bottles, bags, and other bits of rubbish are strewn around the campsites and across the surrounding area (Figure 3). Because there are no lids, rock dassies, rabbits, and crows dig through the trashcans, take the trash out of the cans, and drag it across the landscape. Park maintenance staff argue that visitors at the campsites litter as well. Through conversations with MET maintenance staff, we learned that the trashcans are emptied approximately once a week and transported to a dumping station in Walvis Bay. When this is not possible, the trash is burned in the can, on-site. When private tour operators stop at the Mirabib Campsites, the operator cleans out their tour bus and dumps this trash in the campsite trashcans. In addition, the visitors place rocks on

top of the trash so that the trash does not blow away, but the next people to use the trashcans do not remove the rock. Instead they add their trash to the cans and place another rock on top of their own trash.



*Figure 3: Trash Spread Around the Campsites*

**Discussion:** The combination of animal and visitor activity leads to a polluted campsite. When tour operators add large bags and rocks to the trashcans, the cans fill up quickly with trash not belonging to the campsite visitors, which increases the required maintenance for park maintenance staff. Additionally, the weight of the rocks in the trashcans makes it difficult for park maintenance staff to remove the trash. The remoteness of the campsites limits the frequency with which MET can empty the trashcans. Since Ganab, the nearest maintenance station, is over 70 km from the Mirabib Campsites, it is difficult for the park maintenance staff to keep up with the trash accumulation rate. The MET officials realize that burning the trash is not an ideal waste removal method, but distance limitations leave them with few options. To mitigate the negative impacts of improper waste management, there must be infrastructure that properly stores the trash and minimizes the need for maintenance.

#### **Design Specifications for trashcans:**

*The trashcan must prevent animals from accessing the trash*

- Preventing animals from accessing the trashcan helps reduce the amount of trash that is outside the trashcan, which stops the wind from depositing trash across the Mirabib area.

*Each trashcan must hold at least 200 liters of trash*



- The existing 200 liter drum trashcans were full on some sites, so the trashcans must be able to hold at least this amount of trash.

*The trashcans must be made of a material that is heat resistant*

- When no other options for removal are possible, MET burns the trash. Therefore, the trashcans must be made of a material that will not degrade during the burning of trash.

*The trashcans must discourage people from putting rocks in the trashcans to hold down trash*

- If people do not put rocks in the trashcan, the trashcans will not fill up as fast and be lighter and easier for MET to remove. If the trash is more easily removable, it may reduce the need for MET to burn the trash on-site.

### Showers

**From interviews with tour companies, we found that there is a need for showers at Mirabib.**

**Evidence:** There are no shower facilities or designated shower areas at the Mirabib Campsites. One of the first things campers look for when they arrive at a campsite is a hot shower (D. Jacobs, personal communication, 10 April 2015).

**Discussion:** It is difficult to determine what amenities, beyond basic amenities such as toilets, trashcans, braai pits, and tables, will satisfy all types of visitors. For example, older people will not be interested in the same types of activities as a family with children. However, one additional amenity that satisfies the general visitor is a shower. Within the rock structures, there are potential places to add a naturally sheltered shower with little cost.

#### **Design Specifications for showers:**

*The shower must provide privacy*

- The shower must have a barrier to provide the visitor with privacy while they shower.

*The system must use water provided by the visitor*

- There is no running water at the Mirabib Campsites.

*The shower must heat the water*

- Visitors want hot showers so the system must provide a way to heat the water.

### Signs

**When visitors arrive at the Mirabib Campsites, they have no way of knowing the location or the number of campsites, or where the nearest toilet facility is located.**

**Evidence:** Mirabib does not have any signs indicating the number and location of campsites. Toilet signs exist at only two of the seven campsites. The existing toilet signs point in two directions, making the direction of the nearest toilet facility unclear. The sign in Figure 4 is about five years old, and the sun and harsh environment has faded the text to nearly unreadable.



*Figure 4: Faded Sign Located in the NNP*

**Discussion:** It is difficult for visitors to determine how many campsites are at Mirabib unless they drive all the way around the inselberg. As indicated by the overflowing trashcans at the campsite nearest to the entrance, visitors stop at the first campsite they see because they do not know the other options. In addition, toilet signs must be present at each campsite to improve convenience for visitors by directing them towards the nearest toilet facility. For all signs, the proper material must be selected so that the signs last without needing to be replaced.

#### **Design Specifications for signs:**

*At the fork entrance to the Mirabib Campsites, there must be signs indicating the location of each campsite*

- Since Mirabib is not well-labeled, visitors often camp at the first campsite they see. By adding signs, the visitors will know that there are seven sites and how to get to each one.

*At each campsite, there must be a sign indicating the campsite's number*

- If signs are added, when arriving at each site, the visitor will know that they have reached the site they are looking for.

*The sign must be made of a material that will withstand the arid desert environment*

- If not specially selected for use in a desert environment, the extreme sunlight and temperatures degrades the sign material, making the sign unreadable.

*The text on the entrance sign must be legible to a car driving along the road*

- To help visitors easily navigate to their desired campsite, the sign must be readable the without getting out of the car.

## Toilets

### **The uncleanliness of the toilets discourages visitors from using the designated facilities.**

**Evidence:** The current toilet design includes a simple long drop pit with no concrete or plastic lining, which allows waste to seep directly into the ground (A. Uwukhaeb, personal communication, 23 April 2015). The design does not separate liquid and solid waste, creating an odor. The toilet facility is not closed in, which allows animals to access the area. Hyenas steal the toilet seat covers causing the waste pit odor to spread into the main toilet facility (M. LeRoux, personal communication, 30 March 2015).

**Discussion:** The odor caused by the mixing of solid and liquid waste attracts flies into the toilet facility and creates an unpleasant experience, which deters visitors from using the facilities. Clean bathrooms encourage visitors to use the toilet facilities instead of openly defecating. Additionally, the toilet facility is not currently closed in, which limits visitor privacy.

### **Design Specifications for toilet:**

*The toilet tank must have a closed in pit to contain the solid waste*

- A closed in pit prevents the solid waste from absorbing into the ground, reducing the unpleasant odor.

*The toilet facility must have a ventilation pipe into the waste tank*

- A ventilation pipe helps to move the air inside the facility so the odor is dispersed.

*The structure surrounding the toilet must be enclosed*

- In order for the ventilation pipe to work, the facility must be closed in to create a maximum draft.

*The toilet facility must have a clear or opaque roof*

- Since the facility has to be closed in, it is important to have a roof that allows natural light into the area.

*The toilet facility must separate solid and liquid waste*

- The wetting of solid waste creates a strong smell, so separating the solid and liquid waste reduces the odor in the toilet facility (Alemayehu, 2004).

### Leveling

**Mapping out the campsites showed that many of the areas designated for placing a tent are not flat.**

**Evidence:** From measurements with the inclinometer, we found that all of the seven campsites had an incline between 3° and 10° in the area where a visitor can place a tent. This incline is well above the suggested grade of 1-2° (Designing Camp and Picnic Units, 2015). Only site five had an incline greater than 5° in the area to place tents. The incline maps of the campsites are in Appendix M.

**Discussion:** Inclines present a problem in visitor comfort. From our interviews with private tour operators, we found that visitors do not visit areas where there is not a flat place to pitch their tents. Although the campsites are not flat, the campsites are located in some of the flattest areas within Mirabib. From surveying the area, we found that there are no other naturally flat areas in Mirabib where additional sites could be added.

### Design Specifications for leveling:

*The grade of the campsites must not exceed 5°*

- Although this grade does not fit within the standard 1-2°, it sets a standard for the Mirabib Campsites. If the standard was set at 2°, almost all of the campsites would need to be flattened, taking away from the natural appeal of Mirabib. Setting the standard at 5°, the campsites are only flattened if the discomfort caused to visitors outweighs the need to uphold the natural appeal.

### Layout

**The layout of Mirabib is determined by locations within Mirabib that are shaded by the rocks. The current layout of amenities reduces visitor comfort and safety.**

**Evidence:** From the shade study, we determined that all sites had natural shade from the granite structures for part of the day, and six out of seven sites had shade for the majority of the day. Campsite 3 did not have shade for the majority of the day, but had a structure over the picnic table to provide shade. We found that this shelter, shown in Figure 5, is small and only effective at certain times during the day. The full shade study can be seen in Appendix N. In addition, several braai pits were located on the edge of a drop off, which can be dangerous for visitors (Figure 6). On two sites, the braai pits were less than three meters from the tables. Conversely, on three sites, the braai pits were further than six meters from the tables. On three sites, the trashcans were over fifteen meters from the table. On two sites, there was not a toilet within ninety meters.



*Figure 5: Small Shade Structure*



*Figure 6: Braai Pit Located on Steep Drop Off*

**Discussion:** Without natural shade, the harsh desert sun makes camping uncomfortable for visitors. Amenities must be placed in a location where the inselberg provides natural shade for a majority of the day. Within the area of shade, the amenities must be placed for visitor convenience. For example, the braai pits must be positioned so that visitors can sit comfortably around the braai pit and cook food. The distance between the table and the braai pit must be considered as well. If the table and braai pit are closer than three meters from each other, the visitor cannot escape the smoke and heat created by the fire when sitting at the table. If the table and braai pit are further than six meters apart, the visitor must walk a far distance when cooking. The layout can also be important to reducing environmental concerns. If the trashcan and table are greater than fifteen meters apart, the visitor has to walk a long way to throw away their trash, and is more likely to litter than if the trashcan was nearby. However, if the trashcan is closer than eight meters, the smell detracts from the visitor experience.

**Design Specifications layout:**

*Each campsite must be within ninety meters of a toilet*

- According to the Western Australian Regulations for campsites, the distance from each campsite to the nearest toilet must be within ninety meters (Western Australian Current Regulations, 1994). The campsite may share a toilet with another campsite.

*Each campsite's view into the desert must not be obstructed by infrastructure*

- Part of the appeal of Mirabib is its natural and remote environment. According to MET, “All structures must be designed and constructed to create least visual impacts (MET 2013).

*The trashcan should be eight to fifteen meters from the table*

- Visitors usually prepare their meals at the table, and this is when they produce the most trash. Although there is no standard distance between trashcans and tables for campsites, but with an eight to fifteen meter distance, the trashcan is not so far away that the visitor is tempted to litter, and not so close that the odor and view of the trashcan detracts from the visitor’s experience.

*The braai pit should be three to six meters from the table*

- Visitors usually cook their food over the fire and take it to the table to eat. There is also no standard distance between braai pits and tables. However, the table should be at a distance that is comfortable for the visitor to carry their food from table to braai pit, but not so close that visitors have to inhale smoke or be too hot due to the heat of the fire.

#### *Braai Pit*

**The braai pits do not limit fire size and are not comfortable for visitor use.**

**Evidence:** The braai pit grates were missing on two of seven campsites. The braai pits are elevated to only 10 cm and the braai pit’s concrete base was cracked (Figure 7).



*Figure 7: Braai Pit with Crack in Concrete Base*

**Discussion:** At a height of 10 cm, visitors must squat to use the braai pits which can be uncomfortable. When the braai pit is missing a grate, it is unusable for cooking, inconveniencing the visitor. Visitors can build oversized fires because the braai pit does not limit the size of the fire. The heat produced by large fires creates cracks in the concrete base of the braai pits.

#### **Design Specifications for Braai Pits:**

*The grate on the braai pit must be attached to the rest of the braai pit*

- This ensures that visitors cannot steal the grate, which would make the braai pit unusable for future visitors.

*The braai pit must be made of a material with high resistance to heat*

- If the material is not suited for high heat, the fires will cause cracks and make the braai pit susceptible to damage.

*The braai pit must limit useable amount of wood to a 5 kg bundle*

- If the braai pit limits the amount of useable wood, it will help to reduce the heat created by the fire. If the fire creates less heat, it will help the structure of the braai pit last longer.



*The braai pit must be elevated to a height of approximately 40-50 cm*

- This height ensures that the braai pit is at a comfortable height for standing and sitting. The braai pit should be tall enough so that the visitor does not have to squat over the fire, but not so tall that the fire is at head height when seated.

#### Table

**From site visits to Mirabib, we found that tables had broken and missing chairs and were not comfortable for visitors (Figure 8).**

#### Evidence:

The Mirabib Campsite tables did not follow the standard dimensions for tables. For example:

- The 30 cm tall chairs made the visitors knees bend at a sharp angle.
- Some tables were too high for visitors to comfortably use.
- Each site had six chairs around a small table, making the visitor uncomfortably close to the person in the adjacent chair.
- All sites had the same size table. In smaller sites, the table disproportionately limited the area to put up a tent.



*Figure 8: Table Missing Three of Six Chairs*

**Discussion:** According to the MET maintenance staff, a small group of tourists vandalize the tables. Campsites near major cities (e.g the Volderfederberg Campsites east of Walvis Bay) require table replacements after public school breaks and major holidays. The tables are designed with separate chairs because one piece designs also present concerns. In a one piece design, if one chair

is broken, the whole table must be replaced, raising the cost and amount of labor necessary (M. LeRoux, personal communication, 30 March 2015). From our interviews, we also learned that the MET maintenance staff is in charge of picking up broken seats, dropping the fragments off at a dump facility, and providing replacement seats. Replacing table parts creates additional work for the MET maintenance staff outside of their day-to-day operations. The broken seats can also create an eyesore for the next tourists arriving at the campsites.

#### **Design Specifications for table:**

*The table height must be approximately 75 cm*

- The standard table height is 75 cm (Panero, 2014), so creating a table that is this height helps to ensure the comfort of the visitor when both standing and sitting.

*The seat height must be approximately 45 cm*

- The standard seat height is 43 to 48 cm (Panero, 2014), so creating a chair of this height helps to ensure the comfort of the visitor. Paired with the standard height of the table, the level that the visitor sits at is comfortable for use with the table.

*The seats must be approximately 60 cm apart*

- At this standard distance (Panero, 2014), the visitors can sit comfortably side by side without being too close or bumping elbows.

*The seat must be 20 to 35 cm from the table*

- The most common distance from the table to the chair is 25 to 30 cm (Panero, 2014), but this distance depends on the size of the visitor. Placing it within the most common distance helps to ensure that a maximum number of visitors are comfortable when dining.

*The chairs and table must be individually replaceable in the event of damage*

- It is more cost effective if one damaged chair can be replaced, rather than having to replace the entire table and chair combination.

*The size of the table and the number of chairs must correspond to the recommended number of people for each individual site*

- Each site is a different size. Some sites are only large enough for a two-person tent, while some have room for multiple large tents. A large site needs enough seating to accommodate more than two visitors, but a smaller site does not need a large table taking up more room in the already small area.

Finding 2: Through benchmarking, we found products that could be used in part or as a whole to address infrastructure concerns similar to those at the Mirabib Campsites.

We present useful product findings on:

1. Trashcans
2. Showers
3. Toilets
4. Leveling
5. Braai Pits
6. Table

Detailed product designs can be found in Appendix Q.

Notable features of **Trashcans**:

1. **Lid:** A lid prevents animals from accessing the trashcan. The lid also prevents wind from blowing trash out of full trashcans and spreading it across the gravel plains.
2. **Small Opening:** A small opening discourages tour operators from placing large rocks into the trashcans, which makes it difficult for maintenance staff to remove the trash.
3. **Fits existing trashcans:** A lid that can be installed on the existing trashcans reduces the update costs because there is no need to replace the entire trashcan.

Notable Features of **Showers**:

1. **Visitor Supplied Water:** Water supplied by the visitor eliminates the need for running water at the site.
2. **Wood Compartment to Heat the Insulated Water:** A fire is built within the wood compartment to heat the water. The insulation keeps the water heated which is more comfortable for the visitor.
3. **Solar Heating Bag Design:** The sun heats the water in the solar heating shower bags. Once the water is heated, the visitor hangs up the bag and uses the heated water to shower. Solar shower bags are popular in Namibia.

Notable Features for **Toilets**:

1. **Simple pit design:** The simple pit design does not require expensive parts or installation requirements.
2. **Separation of solid and liquid waste:** The separation of solid and liquid waste reduces the odor inside the toilet facility. The separation also reduces the required maintenance and its environmental impact because the solid waste dries and can be used as fertilizer.

- 3. Ventilation pipe:** The ventilation pipe reduces the odor inside the toilet facility by allowing the air to escape.
- 4. Insect Mesh:** The insect mesh traps insects which reduces the number of insects inside the toilet facility.

#### Notable features of **Leveling**:

- 1. Sand:** Sand flattens and softens the ground at campsites, making them more comfortable for visitors to pitch their tents.
- 2. Retaining Wall:** There are many natural rocks to use for the retaining wall; the retaining wall prevents the sand from washing away.

#### Notable features for **Braai Pits**:

- 1. Elevated Structure:** The elevated braai pits are at a height that allows the user to comfortably cook in both a sitting and standing position.
- 2. Laser Cut Steel Grate:** The laser cut design increases the grate's durability and reduces its tendency to degrade from the heat of the fire.
- 3. Attached Grate:** The attached grate prevents theft by visitors.

#### Notable Features for **Tables**:

- 1. One piece design:** A one piece design improves the table's permanency because it is difficult for visitors to steal individual components.
- 2. Steel frame:** A steel frame improves durability because steel is more difficult to break than concrete.
- 3. Individually replaceable seats:** Individually replaceable seats reduce the repair costs for damaged tables. It is cheaper and easier to only replace one seat than to replace the entire table and chair unit.
- 4. Attached to base:** The attached based design also improves permanency because it prevents visitors from moving or stealing the table and chairs.

## 4.2: Management Plans

This section examines possible management plans for the Mirabib Campsites. The management plans have varied advantages but all are potential plans for Mirabib.

Finding 3: Management plans vary on their monitoring levels and their associated infrastructure requirements.

1. Monthly Monitoring
2. Weekly Monitoring
3. Daily Monitoring
4. On-site Monitoring

#### *Monthly Monitoring*

**Definition:** At campsites with monthly monitoring, fees are collected in an on-site box. The collection box and all infrastructure is unmonitored and it is the visitor's responsibility to pay the proper amount for their visit. The management staff collects fees and maintains campsites monthly.

**Advantages:** The management staff drives out to the campsites only once per month, so petrol and labor costs remain low. The minimal oversight makes visitors feel like they are not constantly being watched so they do not feel that the management staff is intruding. The simple infrastructure gives a natural feeling to visitors camping experience.

**Disadvantages:** Since the management staff is not on-site, there is no enforcement of campsite fees and visitors can tamper with the payment collection box. The infrastructure must be very limited since it can be maintained only once per month and if the infrastructure is damaged, repairs cannot be made quickly.

#### *Weekly Monitoring*

**Definition:** At campsites with weekly monitoring, fees are also collected in a box on-site with no enforcement by management staff. Similar to monthly monitoring, the collection box and infrastructure are relatively unmonitored, and it is the visitor's responsibility to pay for their visit. The management staff collects fees and maintains campsites weekly.

**Advantages:** Management staff visits the campsites only once per week, so petrol and labor costs remain relatively low. With weekly collection, payments do not accumulate in the collection box, limiting temptation of theft. Similar to the monthly monitoring, minimal oversight and simple infrastructure do not take away from the visitors' camping experience.

**Disadvantages:** The petrol and labor costs to maintain the campsites are increased because of the weekly visits. The management staff's lack of on-site monitoring allows visitors to tamper with the payment collection box and choose not to pay for their visit. The infrastructure must be simple if it is maintained only once a week.

### *Daily Monitoring*

**Definition:** At campsites with daily monitoring, staff collects fees and maintains the campsites daily.

**Advantages:** Maintenance staff is on-site daily to collect the fees, so there is no need for a payment collection box. Enforcement of payments increases fees which go towards maintaining and updating the infrastructure. Infrastructure can be updated because it is maintained daily. Any issues that arise can be promptly addressed by management staff.

**Disadvantages:** The petrol and labor costs to maintain the campsite daily are high. Management staff is frequently present to maintain the campsites. With greater frequency in maintenance, infrastructure can be more extensive, which takes away from the natural appeal of the campsites.

### *On-site Monitoring*

**Definition:** At campsites with on-site monitoring, management staff lives on-site. Fees are collected when the visitor checks in for their stay.

**Advantages:** Visitors pay their camping fee to the on-site management staff. This method eliminates the need to pay in an unmonitored collection box or at daily collection times. Any visitor concerns can be addressed immediately by locating on-site management. Infrastructure is maintained whenever needed, so it can be more advanced.

**Disadvantages:** An on-site employee needs a lodge, running water, and full amenities. The cost to pay an on-site employee is very high. Full amenities and constant monitoring by management staff can take away from the natural feel of the area.

## 4.3: Marketing Strategies

Finding 4: Marketing methods for the Mirabib Campsites should be tailored for the following three geographic zones: all international markets, neighboring countries, major cities in Namibia.

From interviews with tourists, Gobabeb experts, MET officials, and Journeys Namibia, we developed a persona for the typical visitor at the Mirabib Campsites. The persona has three traits: passion about the outdoors and respect for the camping environment, appreciation for solitude, and an eco-friendly mindset. These three traits were most prominent when Mirabib tourists were described and interviewed; however, it was difficult to interview visitors because this study was conducted during a low peak tourist season.

Due to geographical restrictions, each location requires different marketing methods to reach the maximum number of potential visitors that fit the developed persona. To tailor methods to different geographical zones, we created the three following groups:

1. All other international markets
2. Neighboring Countries
3. Major Cities in Namibia

#### *All International Markets*

Approximately 60% of all Namibian holiday tourists plan their trips via internet (MET, 2013). Therefore, the internet is the most effective way to get information to people from all over the world. They can learn about Mirabib and plan their trip to Namibia prior to arrival.

#### *Neighboring Countries*

According to the 2012-2013 MET exit survey, approximately 35% of holiday visitors from neighboring countries plan their trips via magazines and guidebooks. The remaining methods that visitors obtain their information are: internet at 50%, previous visits at 47%, friends/relatives at 30%, and other at 15% (MET, 2013). One visitor stated that she found the Mirabib Campsites in *Go! Magazine*, a popular outdoors magazine.

#### *Major Cities in Namibia (Swakopmund, Walvis Bay, and Windhoek)*

We interviewed Blue Crane Safaris and Journeys Namibia, a tour operator and a tour management company, respectively. We found that both companies use brochures to promote various destinations throughout Namibia to tourists. When tourists speak to tour operators and discuss the type of holiday they are looking for, the operators offer brochures for locations that meet the customers' desires. Brochures are an affordable yet effective method to distribute information to tourists. Additionally, we observed a variety of brochures highlighting tourist locations throughout Namibia

Finding 5: Marketing materials need to highlight Mirabib's unique features: a scenic drive, rock climbing, a self-guided nature trail, remoteness and solitude, sunrise and sunset, and stargazing.

#### *A Scenic Drive*

Mirabib lies on a 137km loop that encompasses nearby potential attractions (Figure 9). This scenic drive, accessible by 4x4 vehicles, features a variety of wildlife, geologic, and cultural features that appeal to a wide visitor audience. The scenic drive's seven points of interest are outlined below:

1. **Zebra Pan:** a low lying area with ostrich, oryx, and zebra
2. **Hope Mine:** a dormant copper mine along the schist deposits that visitors can explore

3. **Homeb:** a campsite along the Kuiseb River, famous for the silt deposits in the canyon
4. **Topnaar Villages:** a native community along the Kuiseb River that gives visitors the opportunity to see the traditional villages of the Namib Desert
5. **Welwitschia Plant Community:** an over 1,000 year old endemic plant species
6. **Gobabeb Research and Training Centre:** a world renowned institute for arid land research where visitors can learn about the Namib Desert ecosystem through educational programs and nature walks
7. **Mirabib Hill Shelter:** an archaeological site with ancient cave drawings and cooking tool artifacts



Figure 9: Driving Loop in the Central NNP

### Rock Climbing

Mr. John LeRoux, an expert rock climber and a former NNP maintenance employee, stated that the Mirabib Campsites have the potential to be a rock climbing attraction for skilled climbers. Installation and use of the rock climbing area can be accomplished in an eco-friendly and safe method.

### A Nature Trail

At Mirabib, there are many areas that can be developed into paths. Tourists can walk these paths and learn about the unique features of the area, specifically: geology, flora, and fauna. A nature trail gives tourists the opportunity to learn about Mirabib through educational materials on-site.



### *Remoteness and Solitude*

Approximately one-third of all visitors to Namibia are looking for tranquility (MET, 2013). Mirabib is approximately 30km from the closest native settlement and about 140km from Walvis Bay. Not only is the Mirabib Inselberg remote, but each site is remote. When at one campsite, visitors can neither hear nor see anyone at other campsites, which gives tourists additional tranquility.

### *Sunrise and Sunset*

The flat gravel plains allow for scenic sunrise and sunset views with several granite outcrops along the horizon. Visitors can watch the sunrise over the Gamsberg Plateau to the east and the sunset over the red sand dunes in the west.

### *Stargazing*

Many stars are visible at the Mirabib Campsites because of the minimal light pollution in the area. From speaking with tourism experts, we found that stargazing attracts visitors as a relaxing attraction.

**Finding 6:** If frequent visits to the Mirabib Campsites are required, then the Topnaar People's on-site involvement is limited due to their long distance from the campsites.

There are many community-based campsites in Namibia. The community members manage the bookings, clean the campsites, and entertain the visitors. These campsites can be managed by the local communities because of the limited distance between the communities and the campsites. The campsites are located directly within or adjacent to the local community. The full list of community-based campsites researched is located in Appendix S. Through our research, we found that the nearest Topnaar village is over 30 km from the Mirabib Campsites, much farther than the existing community-based campsites. The distance limits the ability of the Topnaar People to travel daily to the campsites as required. However, the distance is not a concern if an on-site employee manages the campsites. In addition, the Topnaar People's distance from the Mirabib Campsites does not limit their off-site involvement. Popular activities in Namibian community-based campsites include village tours, traditionally prepared meals, and live traditional performances (Levo Tours, 2015). To involve the Topnaar people in the Mirabib Campsites, off-site activities must be established.

## 4.4: Summary

The current state of the Mirabib Campsites has many limitations for use as a tourist destination. We learned that: the infrastructure is neither environmentally friendly nor practical, a

different management plan can increase profit at Mirabib, and marketing of the campsites can increase tourist knowledge of Mirabib.

## Chapter 5: Conclusions and Recommendations

After field visits, interviews, and literature reviews, multiple findings have led to the following recommendations for developing the Mirabib Campsites in Namibia's Namib-Naukluft Park. This chapter includes:

1. Conclusions: A summary of major findings
2. Recommendations on three subjects: Infrastructure updates, Management plans, Marketing strategies
3. Technology and society: Lessons learned while working in Namibia

### 5.1: Conclusions

Research completed on the Mirabib Campsites and other sites in Namibia revealed a possibility for infrastructure updates at Mirabib, both to the individual sites and the campsites as a whole. We identified possible updates for the trashcans, braai pits, tables, toilets, campsite leveling, and campsite layout. Possibilities for other updates, including the addition of showers, were also found. To design updates for each amenity, we found specifications that must be met to satisfy all stakeholders. The goal of the updates was to make the campsites a more desirable destination for tourists while reducing the amount of attention needed from the maintenance staff.

From research of management methods used, we found four monitoring levels for managing Mirabib: monthly, weekly, daily, and on-site. These options give a wide spectrum of possibilities for managing the Mirabib campsites with different levels of capital investment and capital return. All options have advantages and disadvantages for both the tourists and the maintenance staff. A method needs to be implemented that preserves the appeal of Mirabib while taking into consideration the needs of the tourists and the management staff.

Through observation of other campsites, discussions with tour operators, and talking to a tour management company, we identified a need for a marketing plan. The marketing methods should target a certain persona in three specific regions, each requiring a different marketing media. We also found that highlighting the unique aspects of Mirabib attracts visitors to the campsites to stay for multiple nights.

### 5.2: Infrastructure Updates

Recommendation 1: Prioritize infrastructure updates based on environmental concern, benefit to visitor comfort, and cost.

Based on these factors, we recommend the following updates for the Mirabib campsites in this order:

1. Trashcans
2. Showers
3. Signs

4. Sign Board
5. Toilet
6. Leveling
7. Layout
8. Braai Pit
9. Tables

A full design and detailed material costing information for all updates can be found in Appendix R.

### *Trashcans*

**Install a cover to the existing trashcans with a sign that educates users about proper trash disposal.**

The total estimated material cost for this design is N\$2,400 per trashcan lid. This design addresses two issues:

1. *Animal activity*

**Problem:** The trashcans have no lids, allowing scavenger animals to pick at the trash and spread it around the campsite.

**Solution:** The lid prevents animals from picking at the leftover food in the trashcans, which eliminates the opportunity for trash to blow into the desert plains.

2. *Trash buildup from tour operators*

**Problem:** While driving by the campsites, tour operators clean out their tour buses and dispose of their tour group's trash, quickly filling up the campsite trashcans.

**Solution:** A laminated paper sign located on the lid describes the rules for proper trash disposal and the effects it has on park maintenance staff.

### *Shower*

**Install a solar shower bag hook area with privacy rope to increase visitor comfort.**

The total estimated material cost for this design is N\$2,200. This design addresses two issues:

1. *Running water*

**Problem:** There is no running water at Mirabib.

**Solution:** The visitors use their own water supply and solar bag to take personal showers. Therefore, visitors can take showers without needing a water source at Mirabib.

## 2. *Visitor Comfort*

**Problem:** There are no shower facilities at Mirabib.

**Solution:** Since many tourists own personal solar shower bags, providing them with a designated area and infrastructure to hang their solar shower bags improves comfort.

## *Signs*

**Install signs to direct visitors to all seven campsites and necessary amenities.**

The total estimated material cost for this design is N\$350 per toilet sign, N\$350 per campsite sign, and N\$6,500 for the entrance sign. This design addresses four issues:

### 1. *Visitors' awareness of existing campsites*

**Problem:** Visitors do not know how many campsites are around the Mirabib inselberg.

**Solution:** A sign post at the Mirabib Campsites entrance indicates the direction of each site and the total number of sites. Visitors are more likely to camp at sites towards the back of the inselberg if the visitors knew the sites existed.

### 2. *Trash distribution*

**Problem:** Campsite 3, the campsite nearest to the entrance, has the most traffic as shown by the overflowing trashcans.

**Solution:** The installation of a sign that indicates the number of campsites disperses visitors and decreases the trashcan overflow at campsites, reducing the frequency of maintenance needed.

### 3. *Wear to campsite amenities*

**Problem:** The table at Campsite 2, the campsite nearest to the entrance, is missing three of six chairs. Due to higher traffic, the infrastructure at the more popular sites degrades faster than the infrastructure at the other sites.

**Solution:** Evenly distributing the visitors reduces wear on the infrastructure at more visited sites.

### 4. *Visitors awareness of campsite locations and nearest toilet facilities*

**Problems:** Five of seven campsites had no sign indicating the direction to the nearest toilet facility. No campsites had a sign indicating the campsite number.

**Solutions:** A toilet sign at each site improves convenience for visitors. Signs that indicate the campsite number helps visitors know that they have reached their desired site.

### *Sign Board*

**Install an additional informational sign board to educate visitors about Mirabib.**

The total estimated material cost for this design is N\$2,100. This design addresses two issues:

1. *Visitor knowledge about the surrounding area*

**Problem:** There are no materials to educate visitors about the area.

**Solution:** An informational board near the fork in the road by the entrance informs visitors about the geology, flora and fauna and interesting facts unique to the Mirabib area. This board reminds visitors that they are in a National Park, and politely asks them to please clean up after themselves.

2. *Awareness of existing campsites*

**Problem:** Visitors often stay at the sites closest to the entrance, unaware of the campsites towards the back.

**Solution:** A map shows the visitor the various site options, which helps the visitor to choose the most appropriate site.

### *Toilet*

**Install eco-friendly toilets that ventilate the waste pit, prevent the entrance of insects, and separate the solid and liquid human waste.**

The total estimated material cost for this design is N\$50,000. This design addressed three issues:

1. *Animal Activity*

**Problem:** The toilet facilities are open which allows animals, such as hyenas, to access the toilet facility.

**Solution:** The enclosed design blocks off hyenas from stealing the toilet seat and prevents other animals from entering the toilet facility.

2. *Odor in toilet facility*

**Problem:** The wetting of solid waste creates a strong unpleasant odor.

**Solution:** The toilet bowl separates the waste prior to mixing. This separation allows the solid waste to quickly dry in the waste pit. Dried solid waste produces little odor and can be removed as fertilizer. The ventilation pipe provides additional odor relief by drawing air out of the pit and outside the toilet facility.

3. *Flies inside the toilet facility*

**Problem:** The odor from wetted solid waste attracts insects into the toilet facility.

**Solution:** The insects flying around in the pit are attracted to the light at the top of the ventilation pipe and when the insects fly up the pipe, they are trapped by the insect mesh and die.

### Leveling

#### Add sand with a retaining wall to flatten campsites.

The total estimated material cost for this design is N\$1,800. This design addresses two issues:

1. *Area to place tents*

**Problem:** The natural slope of Campsite 5 limited the potential flat areas to place a tent.

**Solution:** Flattened campsites give visitors more area to place their tents and adds the option for larger tents.

2. *Visitor comfort*

**Problem:** The recommended incline for a tent area is 1-2°, but Campsite 5 has an incline greater than 5° which it is uncomfortable for visitors.

**Solution:** Using sand with a retaining wall flattens the campsites and softens the ground, improving the visitor's sleeping conditions.

### Layout

#### Change amenity layout to improve comfort and safety for visitors.

This update has no material costs. The new layout design addresses three issues:

1. *Visitor comfort*

**Problem:** The braai pit locations limit the number of visitors that can sit around the fire.

**Solution:** Moving the braai pits into central locations allow room for visitors to sit around the perimeter of each braai pit.

## 2. *Visitor safety*

**Problem:** On two campsites, the braai pits were located on the edge of a steep drop off.

**Solution:** The braai pit locations eliminate the dangers associated with the previous locations.

## 3. *Visitor convenience*

**Problems:** At two sites, the braai pits are closer than 3 meters from the tables. However, at three sites, the braai pits are further than 6 meters from the tables. At three sites, the trashcans are further than 15 meters from the table. At two sites, there are no toilets within 90 meters.

**Solutions:** Locating braai pits between 3-6 meters from the table, and ensuring there is a toilet within 90 meters from each site increases convenience for visitors. Placing trashcans between 8-15 meters from the table also increases convenience for visitors while encouraging them to use the trashcans rather than leaving their trash at the table.

### *Braai Pit*

#### **Install taller braai pits with fixed grates that limit the maximum fire size.**

The total estimated material cost for this design is N\$2,400 per braai pit. This design addresses three issues:

#### 1. *Grates*

**Problem:** At two campsites, braai pits are unusable because of missing grates.

**Solution:** A built-in grate design discourages visitors from removing and stealing the grates.

#### 2. *Fire size*

**Problem:** The open slab design does not limit the amount of wood visitors can use inside the braai pit. A large amount of wood produces large fires and excessive heat, which cracks the braai pit's concrete.

**Solution:** The braai pit design limits the amount of wood and coals that can fit inside the braai pit, reducing the size of fires. Smaller fires create less heat, preserving the concrete.



### 3. Height

**Problem:** While cooking, the visitors are required to uncomfortably squat because the braai pits are only 10cm tall.

**Solution:** The braai pit design is 40cm tall, allowing the visitor to comfortably cook while either in a standing or seated position. While in a seated position, the fire base is at a standard chair seat height.

#### Table

**Install a steel framed concrete table with replaceable concrete chairs to reduce maintenance requirements.**

The total estimated material cost for a six chair design is N\$4,400 per table. This design addresses three issues:

#### 1. Durability

**Problem:** In the multi-piece design, chairs go missing and are easily broken.

**Solution:** The steel frame and one-piece design increases the durability of the table. In a dry climate, the steel frame rusts at a lower rate in a dry climate than in a wet climate.

#### 2. Cost of replacement components

**Problem:** When one chair breaks in the one-piece design, the entire table and chair unit must be replaced. Therefore, damage to the table has a high replacement cost.

**Solution:** In the table design, the replacement of individual concrete chairs does not require the replacement of the entire table and chair unit. This feature reduces the overall replacement costs.

#### 3. Visitor Comfort

**Problems:** The visitor's knees are bent at a sharp angle when in a seated position because the chairs are low to the ground. Chairs are positioned too close to adjacent chairs, forcing visitors to sit uncomfortably close to the adjacent visitors. Compared to the height of the chairs, the tabletop is too tall for comfortable use.

**Solutions:** The table design has standard measurements for chair height, table height, and distance between chairs at the table.

### 5.3: Management Plans

Recommendation 2: Of the four possible monitoring levels, we recommend that the Mirabib Campsites experiment with weekly monitoring and implement an honor system for collecting campsite fees.

A detailed management plan is found in Appendix T.

**Description of Weekly Honor System:** Visitors pay for overnight camping at the Mirabib Campsites at a secured payment box, located at the entrance of the campsites. Once per week, the maintenance staff visits the Mirabib Campsites, withdraws the money from the payment box, and cleans the campsite. This money is used to clean the campsites once per week and improve the infrastructure to enhance the visitor experience.

**Advantages:** This method conserves the undeveloped natural feel of the Mirabib Campsites. Luxury amenities take away from the solitude and natural beauty of the Mirabib area. Conservative infrastructure updates encourage environmentally mindful visitors who are looking for an undeveloped, natural campsite.

**Disadvantages:** Since the visitor fees are submitted on-site at a mostly unmonitored payment box, visitors have the opportunity to vandalize the payment box. In Namibia, instances of unmonitored campsite vandalism occurred at the Brukkaros Campsites in the Karas Region (Berseba-Nampa, 2012). However, after interviews with park maintenance staff, we determined that the Mirabib Campsites attract responsible, respectful visitors.

### 5.4: Marketing Strategies

Recommendation 3: Create a brochure, print/online publications, and web page to that reach the target audience in Namibia, neighboring countries, and international countries to promote the Mirabib Campsites.

First, we recommend the distribution of a promotional brochure to major cities in Namibia. A sample template can be found in Appendix O. The major cities for distribution include Swakopmund, Walvis Bay, and Windhoek. The brochure targets tourists who want to leave the urban environment and camp at a remote campsite. Second, the print/online publications are published in forms of media across South Africa and Botswana, including *Go! Magazine* and other popular travel magazines that are distributed throughout Southern Africa. A full list of publications and information to put in each can be found in Appendix P. The publications attract tourists from neighboring countries. Third, the website reaches international tourists who are not in Namibia nor

receive subscriptions to travel magazines. The internet is the largest marketing tool and will allow people from all over the world to access information about Mirabib.

Recommendation 4: To attract visitors to the Mirabib Campsites, promote the scenic drive, rock climbing, self-guided nature trail, remoteness and solitude, sunrises and sunsets, and stargazing in marketing materials, but exclude the Mirabib Hill Shelter and the Welwitschia Plant Community.

We determined that the Mirabib Hill Shelter and Welwitschia Plant Community should not be included in marketing materials for the following reasons:

#### *Mirabib Hill Shelter*

The Mirabib Hill Shelter archaeological site is an active research area that is not open to the public. Visitors to this site could disrupt the current research by damaging uncatalogued artifacts.

#### *Welwitschia Plant Community*

The endemic Welwitschia plants are located in an unprotected area. In addition, the Welwitschia Plant Community is being researched. Therefore, unmonitored visitors could disrupt the research and damage the endemic plant through improper, direct contact. However, future efforts could include the Welwitschia Plant Community in visitor attractions but in a controlled and monitored way.

### 5.5: Future Studies

At the completion of this project, there are still a few aspects that were not fully addressed. With these, we have compiled a future study that could be done to supplement our research and expand the scope of this project.

Recommendation 5: Investigate ways to include the local Topnaar People with the Mirabib Campsites.

Currently, the Topnaar people are not involved in the operations of the Mirabib campsites. Mirabib is over 40km away (by the road) from the nearest Topnaar village. As far as we are aware, the Topnaar have no legal claim on the land that Mirabib sits on; however, many would argue that the Topnaar people were on the land before the National Park was created, and therefore have a moral claim on the land.

There is still uncertainty from different parties about the tourism and developing concessions, once they are sorted out, a future study on possible ways to include the Topnaar in

Mirabib can be carried out. Research shows many successful examples of community based campsites in Namibia (Appendix S). Often in Namibia, these campsites are directly in or adjacent to the local village, which is not the case with the Topnaar and Mirabib. A lack of transportation for the Topnaar presents a logistical constraint. A future study will be needed to identify possible ways to include the Topnaar beyond this.

## 5.6: Principles in Overseas Project Design

Completing a project of this size in a foreign country teaches many lessons about research and project design beyond the technical aspect of the project. We learned many lifelong lessons from firsthand cultural experiences during our time in Namibia.

### *Face to face conversation is highly valued and appreciated*

With lives centered on technology, we often prefer electronic communication over face to face interactions. On the WPI campus, we are fortunate enough to have abundant internet and electricity. As students, we live busy lives, and electronic communication is tempting for the sake of convenience. Electronic communication can make conversations very straight-forward, and eliminate the need to be in the same place at the same time. Many Americans, especially the younger generation, have developed a dependency on technology. We quickly learned that this is not the case in Namibia. Compared to Americans, Namibians work on a much more personal basis. They value the power of face-to-face conversation. If you want to communicate with someone, you go to their office and ask them to talk. If meeting in person is not possible, you pick up the phone and call them. People are not constantly checking their emails. Even when you go to talk to someone, it is not the super-efficient “say what you need to say” conversations that Americans have; it is much more casual and personal. Relationships matter. Even in stores or when taking taxis, you often will not get service until you have a brief conversation. The more personal interactions may have taken a bit of time to get used to, but is part of the culture and we had to learn to adjust to the norms of Namibia.

Although Namibia has plenty of land, with one of the lowest population densities in the world, Namibia can seem like a very small country. It often seems that everyone knows everyone, just like in a small town in the United States. This creates a very friendly atmosphere and, as mentioned above, puts a large emphasis on personal connections. When people say they want to see you again, they are not just being nice, they sincerely hope to see you again. If they offer for you to come to dinner, they actually want you to go to dinner, and if they are ever in the United States they will go out of their way to come visit you.

*Every story has multiple viewpoints*

While this is true everywhere in the world, it was important to remember as we worked through this project. It is very easy to get caught up on one side of a story and jump to conclusions without even realizing that there are other perspectives. It was important to make sure that we were working with the most well rounded story possible to ensure that no crucial pieces of the project were excluded. Different parties often know different pieces of the story, and only by taking the time to talk to everyone can one fully understand the situation.

Similarly, politics can be complicated and have many sides. Conversations about our sponsor, the local people, and the government revealed many sensitive topics. We learned to be very careful not to step on any toes or create any more tension among these parties. Some confusion was just beyond our control, and had to be sorted out at a higher level. Being caught a bit off-guard showed us very quickly just how important the words of four undergraduate students were, and how they must be used very carefully.

*Roll with it*

Things don't always go according to plan, and you never know what obstacles you may find in your path. It was important to always have a back-up plan (or three) for when things didn't go as planned. Even the smallest things, like the electricity going out or the taxi getting lost, could mess up a plan, and being able to smile and go with the flow is a key part of working in the developing world. Often, all one can do is relax, be flexible, and know it will all work out eventually. Not everything (in fact almost nothing) will go your way, and often there is nothing you can do about it. There is no sense of stressing over everything; all you can do is relax, laugh about it, and roll with the punches.

*Time is Relative*

Most Americans have an idea of "island time." The connotation that often comes to mind is being on vacation: relaxed, taking things as they come, no schedule, no plans. This is a way of life in many parts of the world, including Namibia. Nobody is in a rush or on a tight schedule. Things happen when they happen, and schedules are only approximations. Coming from the very structured and punctual WPI community, this was difficult to adjust to. When we were trying to schedule meetings or in a hurry to get somewhere, it could be frustrating at times when the world around us was in no particular hurry, and we had no choice but to take a deep breath and relax. In retrospect, the Namibians (and much of the world) may be onto something. In Namibia, things may not get done as efficiently as in the United States, but many people are much more relaxed and generally much happier. Sem Shikongo, Director of Tourism in Namibia's Ministry of Environment and Tourism, summed this up best with: "In the United States you have a watch, but in Namibia we have time."

## Chapter 6: Bibliography

- ACACIA Project E1. *Digital Atlas of Namibia* (Digital ed.).
- Alemayehu, E. (2004). Solid and Liquid Waste Management: For Health Extension Workers: Jimma University.
- Balmford, A., Green, J., Anderson, M., Beresford, J., & Huang, C. (2015). Walk on the Wild Side: Estimating the Global Magnitude of Visits to Protected Areas. *PLoS Biology*, *13*(2), e1002074. doi: 10.1371/journal.pboi.1002074
- Barbecues. Retrieved 15 April 2015, from [http://www.outdoorcreations.com/bbq\\_details.php](http://www.outdoorcreations.com/bbq_details.php)
- BERSWBA-NAMPA. (2012). Brukkaros Campsite Vandalised. *Namibian Sun*. Retrieved from <http://www.namibiansun.com/content/national-news/brukkaros-campsite-vandalised>
- Board, N. T. Namibia: Endless Horizons. 2015, from <http://namibiatourism.com.na>
- Boiteko Campsite. (2015). Retrieved 14 April, 2015, from <http://boitekocamping.wheretocamp.na>
- Buckley, R. (January 2015). *Ecotourism: Principals and Practices: Google Books*.
- Burke, A. (2003). Inselbergs in a Changing World: Global Trends. *Diversity and Distributions*, *9*(5), 375-383.
- Burke, A. (2005). Biodiversity Patterns in Arid, Variable Environments: A Case Study of Namibian Inselberg and Mountain Floras. *Mountain Research and Development*, *25*(3), 228-234.
- Campbell, L. Ecotourism in Rural Developing Communities. *Annals of Tourism Research*, *26.3*, 534-553.
- Cooper, C., Hall, C. M., & Timothy, D. J. (2009). *Sustainable Tourism in Southern Africa: Sustainable Communities and Natural Resources in Transition* Aspects of Tourism, J. Saarinen, F. Becker, H. Manwa, & D. Wilson (Eds.),
- Directorate of Environmental Affairs. (2008). Procedures and Guidelines for Environmental Impact Assessment (EIA) and Environmental Management Plans (EMP): Ministry of Environment and Tourism, Windhoek.
- Directorate of Tourism. (04 December 2008). *National Policy on Tourism for Namibia*. Republic of Namibia: Ministry of Environment and Tourism.
- Durbach, D. (2008a). Eco-tourism threatens tribal welfare in India. *Mali & Guardian: Africa's Best Read*.
- Eckardt, F. D., Livingstone, I., Seely, M., & Von Holdt, J. (2013). An introduction to the surface geology and geomorphology around Gobabeb, Namib Desert, Namibia. *Geo-grafiska Annaler: Series A, Physical Geography*, *95*, 271-284. doi: 10.1111/geoa.12028
- Eckardt, F. D., Soderberg, K., Coop, L. J., A.A., M., Vickery, K. J., Grandin, R. D., Henschel, J. (2013). The Nature of Moisture at Gobabeb, in the Central Namib Desert. *Journal of Arid Environments*, *93*, 7-19. doi: 10.1016/j.jaridenv.2012.01.011

- Eco Solution CC. Advanced Dry Toilet Systems. Retrieved 15 April 2015, from <http://www.otjitoilet.org/toilet/toilet.htm#degradation>
- Fallick, D. How to build a safe, effective wood-fired hot water heater.
- Fennell, D. A. (1999a). *Ecotourism: An Introduction*: Routledge.
- Fig, D. (2008). Stripping the Desert: Uranium Mining inside Namibia's Namib-Naukluft National Park. *South African Review of Sociology*, 39(2), 245-261. doi: 10.1080/21528586.2008.10425089
- Furniture, K. Toaroha Table Collection. Retrieved 15 April 2015, from <http://www.kotukufurniture.co.nz/toaroha.html>
- Galvan Sport. Vandal-proof tables: for four players. Retrieved 15 April 2015, from <http://www.interempresas.net/Gardening/Companies-Products/Product-Vandal-proof-tables-Galvan-Mesa-Naipes-antivandalica-88028.html>
- Goat Project Suffers Setback. (29 Jan. 2013). *Africa News Service*.
- Gobabeb Research and Training Centre. from <http://www.gobabebtrc.org>
- Goudie, A., & Viles, H. (2015). *Landscapes and Landforms of Namibia* Retrieved from [https://books.google.com.na/books?id=Ld\\_VBAAAQBAJ&printsec=copyright&source=gbs\\_pub\\_info\\_r#v=onepage&q&f=false](https://books.google.com.na/books?id=Ld_VBAAAQBAJ&printsec=copyright&source=gbs_pub_info_r#v=onepage&q&f=false)
- Grainger. Drum Top: Tough Guy. Retrieved 15 April 2015, from [http://www.grainger.com/product/TOUGH-GUY-Drum-Top-WP17944/\\_/N-nq1?s\\_pp=false&picUrl=//static.grainger.com/rp/s/is/image/Grainger/4PGF3\\_AS01?\\$smthumb\\$](http://www.grainger.com/product/TOUGH-GUY-Drum-Top-WP17944/_/N-nq1?s_pp=false&picUrl=//static.grainger.com/rp/s/is/image/Grainger/4PGF3_AS01?$smthumb$)
- Guidelines on the information to be contained in Environmental Impact Statements. (2002). Ireland: Environmental Protection Agency CAAS Environmental Services Ltd.
- Hamilton III, W. J., Henschel, J. R., & Seely, M., K. (2003). Fog collection by Namib Desert beetles. *South African Journal of Science*, 99, 181.
- Health, A. G. D. o. (2010). 4 Pit, bucket and chemical toilets. Retrieved 28 April 2015, 2015
- Henry, R. K., Yongsheng, Z., & Jun, D. (2006). Municipal Solid Waste Management Challenges in Developing Countries-Kenyan Case Study. *Waste Management*, 26, 92-100.
- Henschel, J. R., & Lancaster, N. (2013). Gobabeb-50 years of Namib Desert Research. *Journal of Arid Environments*, 93, 1-6. doi: 10.1016/j.jaridenv.2012.09.015
- Honey, M. (2008). *Ecotourism and Sustainable Development*. Washington DC: Island Press
- Hoole, A. (2008). Place, Prospects and Power: Community-Based Conservation, Partnerships, and Ecotourism Enterprise in Namibia.
- Hubbard, D. (2008). Guide to the Environmental Management Act: No 7 of 2007.
- Industrial, G. Stone Panel Ash Trash Receptacles. Retrieved 15 April 2015, from <http://www.globalindustrial.com/g/janitorial-maintenance/garbage-recycling/ash->

trash/stone-panel-ash-trash-receptacles

Ito, M. (2005). Changes in the Distribution of the !Nara Plat that Affect the Life of the Topnaar People in the Lower Kuiseb River, Namib Desert. *African Study Monographs*, 30, 65-75.

Jernigan, M. How to Make a Donkey Boiler. Retrieved 15 April 2015, from [http://www.ehow.com/how\\_12189953\\_make-donkey-boiler.html](http://www.ehow.com/how_12189953_make-donkey-boiler.html)

Kaumbangere Camp Site. (2015). Retrieved 14 April, 2015, from <http://www.namibweb.com/kaumbangere.htm>

Lema, J., Agrusa, J., & Agrusa, W. (2009). Tourism in Mountain and Remote Regions. *Journal of Tourism Challenges and Trends*, 11(1), 11-25.

Lethlean, T. C. (2003). River Murray Sustainable Recreation Site Planning and Implementation Guide. Berri SA.

Lindsay, H. (2003). Ecotourism: the promise and Perils of Environmentally-Oriented Travel. *Cambridge Scientific Abstracts, Inc.*

Liu, Z. (2003). Sustainable Tourism Development: A Critique. *Journal of Sustainable Tourism*, 11(6), 459-475.

Martin, M. (2003). Bush Tech #18: Pit Toilets: Centre for Appropriate Technology.

MET. (September 2013). *Management Plan: Namib Naukluft Park.*

Namib Desert. (2014) *New World Encyclopedia* (Web ed.).

Novelli, M., Barnes, J. I., & Humavindu, M. (2006). The Other Side of the Ecotourism Coin: Consumptive Tourism in Southern Africa. *Journal of Ecotourism*, 5(1-2), 62-79. doi: 10.1080/14724040608668447

Odendaal, W. (5 October 2007). 100 Years of Etosha Not Everyone is Celebrating. *The Namibian*.

Omatako Valley Rest Camp. (2015). Retrieved 14 April, 2015, from <http://www.omatakovalley.com>

Outdoor Creations Inc. Rectangle Tables. Retrieved 15 April 2015, from [http://www.outdoorcreations.com/rectangle\\_tables.php](http://www.outdoorcreations.com/rectangle_tables.php)

Outdoors, B. Round Concrete Picnic Table. Retrieved 15 April 2015, from <http://www.belson.com/Round-Concrete-Picnic-Table-with-Steel-Frame>

Panero, J., & Zelnik, M. (2014). *Human Dimension and Interior Space: A Source Book of Design Reference Standards*: Watson-Guptill.

Paresashvili, N. (2014). Major Tasks of Ecotourism Management in Georgia. *9th International Scientific Conference Economics and Management*, 156, 170-173.

Partidário, M. R. (1996). Strategic Environmental Assessment: Key Issues Emerging from Recent Practice. *Environmental Impact Assessment Review*, 16.1, 31-55.

Permaculture, M. (2009). The Rocket Powered Shower. Retrieved 15 April 2015, from



- <http://permaculturenews.org/2009/09/01/the-rocket-powered-shower/>
- Planet, A. Animals of the Namib Desert. from <http://www.animalplanet.com/tv-shows/wild-kingdom/videos/animals-of-the-namib-desert/>
- Quad-Bike Adventure. (2013). Retrieved 14 April, 2015, from <http://springbokatlas.com/destination/namibia/day-tours/quad-bike-adventure/>
- Regulations, W. A. C. (1997). *Caravan Parks and Camping Grounds Regulations 1997-Schedule 7*. Retrieved from [http://www.austlii.edu.au/au/legis/wa/consol\\_reg/cpacgr1997406/sch7.html](http://www.austlii.edu.au/au/legis/wa/consol_reg/cpacgr1997406/sch7.html).
- Ringer, G. R., Alan. (1999). Con Dao National Park Ecotourism Management and Environmental Education Proposal.
- Ross, S. (1999). Ecotourism: Towards Congruence between Theory and Practice. *Tourism Management, 20.1*, 123-132.
- Rupara Community Camp. (2012). *Tracks4Africa*. Retrieved 14 April, 2015, from <https://tracks4africa.co.za/listings/item/w252844/>
- Ruppel, O. C., & Ruppel-Schlichting, K. (2011). *Environmental Law and Policy in Namibia*. Windhoek, Namibia: OrumbondePress.na & Welwitschia Verlag Dr. A. Eckl, Essen.
- Sarmiento, V. C., & Santos, P. J. P. (2012). Trampling on Coral Reefs: Tourism Effects on Harpacticoid Copepods. *Coral Reefs, 31*, 135-136. doi: 10.1007/s00338-011-0827-2
- Scheyvens, R. (1999). Ecotourism and the Empowerment of Local Communities. *Tourism Management, 20(2)*, 245-249.
- Snively, S. W. (2012). Environmental Laws of Namibia: Constitutions, Conservation and Cheetahs. *Probate and Property, 44+*.
- Spriggs, A. Africa: Namibia. Retrieved 7 February 2015, from <http://www.worldwildlife.org/ecoregions/at1315>
- Thuiller, W., Midgley, G. F., Hughes, G. O., Bomhard, B., Drew, G., Rutherford, M. C., & Woodward, F. I. (2006). Endemic species and ecosystem sensitivity to climate change in Namibia. *Global Change Biology, 12*, 759-776. doi: 10.1111/j.1365-2486.01140.x
- Tisdell, C., & Wilson, C. (2012). Can Nature-based Tourism Help Conservation?, 2015
- Tisdell, C. W., Clevo. (2000). A Study of the Impact of Ecotourism on Environmental Education and Conservation: The Case of Turtle Watching at an Australian Site (pp. 1-12): The University of Queensland.
- Topnaar Combo. (2015). Retrieved 14 April, 2015, from <http://www.levotours.com/our-tours/topnaar-combo>
- Topnaar Tours. (2013a). from <http://www.photoventures-namibia.com/coastal-tours#topnaar>
- Topnaar Tours. (2013b). Retrieved 14 April, 2015, from <http://www.photoventures-namibia.com/coastal-tours#topnaar>

- Topnaars Receive Goats. (27 Jan. 2014). *Africa News Service*.
- Toppers Receive Tourism Concession. (2 Sept. 2014). *Africa News Service*.
- Treesleeper Camp: Your Cultural Experience in the African Bush. (2015). Retrieved 14 April, 2015, from <http://www.treesleeper.org>
- Tsaur, S.-H., Lin, Y.-C., & Lin, J.-H. (2006). Evaluating Ecotourism Sustainability from the Integrated Perspective of Resource, Community and Tourism. *Tourism Management*, 27.4, 640-653.
- Van Damme, P., & Van Den Eynden, V. (1922). Topnaar or Hottentot? The People on the Top Revisited. *Afrika Focus*, 8, 215-221.
- Van Damme, P., & Vernemmen, P. (1922). The Natural Environment of the Namib Desert. *Afrika Focus*, 8, 202-214.
- Viles, H. A., & Goudie, A. S. (2013). Weathering in the central Namib Desert, Namibia: Controls, processes, and implications. *Journal of Arid Environments*, 93, 20-29. doi: 10.1016/j.jaridenv.2011.09.012
- Wasenaar, T. D., Henschel, J. R., Pfaffenthaler, M. M., Mutota, E. N., Sely, M. K., & Pallett, J. (2013). Ensuring the future of the Namib's biodiversity: Ecological restoration as a key management response to a mining boom. *Journal of Arid Environments*, 93, 126-135. doi: 10.1016/j.jaridenv.2012.05.012
- Weaver, D. (2001). *The Encyclopedia of Ecotourism* (pp. 668).
- Weaver, D., & Lawton, L. (2007). Twenty Years On: The State of Contemporary Ecotourism Research. *Tourism Management*, 28.5, 1168-1179.
- Williamson, E. (2013). National-Park Visitors are asked to Take Their Trash with Them. *The Wall Street Journal*. Retrieved from <http://www.wsj.com/articles/SB10001424127887323664204578609552803040998>
- World Wildlife Foundation. (2015). Namib Desert, Southwestern Africa. from [http://wwf.panda.org/what\\_we\\_do/where\\_we\\_work/namib\\_desert/](http://wwf.panda.org/what_we_do/where_we_work/namib_desert/)

## Appendix A: National Policy on Tourism for Namibia, Principles of Policy (MET, 2008)

1. Tourism policy must serve government objectives and shall be for the benefit of all Namibians and visitors. Government intervention, whether in the form of regulation, facilitation or investment, will be driven by national interest, not by narrow self-interests. This policy is promoting both domestic as well as international tourism. Promoting domestic tourism will ensure that Namibians also enjoy the beauty of their tourism attractions.
2. Tourism needs to be competitive. Attracting investment and successful marketing require positive interventions by government to create a competitive business environment which enhances the country's ability to compete internationally and regionally.
3. The tourism policy must enable the private sector to operate and compete effectively in global markets to generate responsible tourism. Government recognizes the contribution that the private sector makes towards government objectives.
4. Increased local participation and equity are essential to spread the benefits of tourism. Broad-based black economic empowerment will underpin the future of society and the economy. Both men and women must develop appropriate skills which equip them to become fully involved in profitable business operation, management and ownership.
5. Tourism development must be economically, socially and environmentally sustainable. Namibia neither wants, nor can afford to permit, tourism that yields only short-term benefits and leave behind a wake of destruction, de-motivation or disruption to the fabric of local life.
6. Sustainability is inextricably linked to the protection of the natural resource base namely, environment, aesthetic value, wildlife and culture. Government recognizes the need to be involved in managing, promoting and financing aspects of these.
7. The government's investment and operational functions with regards to the tourism sector are related to the areas of infrastructure development, marketing, education and skills development. Government will further facilitate the identification and removal of strategic barriers to tourism development and thus create an enabling environment for the tourism sector to operate competitively. It is also government's responsibility to ensure conservation, quality standards, fiscal policies and the provision of a rational in these areas, without which Namibian tourism will not achieve its potential. Government owned tourism enterprises such as Namibian Wildlife Resorts and Air Namibia need to operate on commercial principles.
8. Tourism investment, development and promotion must market-driven. Assessment of the market potential and viability must be undertaken before committing resources. Otherwise projects risk failure, wastage of resources, local de-motivation, and the opportunity cost of these resources being invested in viable development projects elsewhere. If not however, there must be a valid justification on the basis of national economic benefit or on social or environmental factors, e.g. conflict resolution, wildlife conservation, community cohesion...
9. It is the government policy to promote interventions on the basis of national economic benefits.
10. The human factor is of prime importance in tourism. The quality of service provided should be of a standard that meets the requirements of present day national, regional and international tourism.

[Return to Top](#)

## Appendix B: Interview Protocol for Tourists

The following questions were asked to the tourists in the form a casual conversation. Before beginning, a brief description of the scope of the project will be given, and the visitors will be asked if they would like to participate. No personal information will be collected. The following script will be read:

“Hello, we are a group of students doing a research project and we would appreciate your help. Our project is to update the infrastructure at the Mirabib Campsites, but in a way that leaves the surrounding environment and local culture unaltered. Would you be willing to discuss your experiences and suggestions with us?”

1. Why did you choose to stay at the Mirabib campsites over other options such as lodges?
2. What activities would you like to do while in the area, but are not available?
3. What existing infrastructure (toilets, trash cans, and basic amenities) do you like?
4. What infrastructure updates would you like to see done to the campsites?
5. Have you visited any other secluded, natural campsites? If so, what types of infrastructure was there?
6. What activities are you doing while staying at the campsites (hiking, sightseeing, etc)?
7. Have you ever heard of ecotourism?
8. Do you have an idea in mind about what makes a destination an ecotourism site? If so, what aspects does a site need to be an ecotourism site?
  
9. Before visiting the area, did you learn about the environment here?
10. Do you know of any environmental concerns specific to this area? If so, do you know ways in which you could harm the environment and ways to prevent it?
  
11. Did you know that the desert here is very alive? With both animal and plants, and people?
12. Are you interested in learning about the culture of the people local to this area? What about environmental concerns of this area? Why or why not?
  
13. What was your favorite thing about your stay at Mirabib?

## Appendix C: Interview protocol for Key Experts at Gobabeb

We asked training experts at Gobabeb the following questions. The interviews were informal, yet structured. They were conversational but still helped obtain the necessary information.

### Content Questions

1. What are the environmental concerns at Mirabib?
2. What information is essential to visitors? (Safety, Trails, etc...)
3. How can visitors prevent environmental damage?
4. How can visitors help conserve the environment during their stay at Mirabib?
5. What are some interesting facts about the Namib-Naukluft National Park?

### Design Questions

1. What types of materials should be made? (Brochures, signs, interactive displays, etc...)
2. What is the most feasible option for education materials?
3. What structure of materials has worked to educate tourists in the past?
4. What is the budget for educational materials?

## Appendix D: Interview Protocol for Management Staff at the Ministry of Environment and Tourism

To learn about the current operations and management, we interviewed the management staff the MET. These interviews were structured yet informal and conversational. We asked the following questions:

1. What are the day-to-day activities of the maintenance staff?
2. What do maintenance staff look for on routine maintenance trips?
3. How often are the Mirabib Campsites cleaned?
4. Is this the same for other campsites in the park? Homeb, Volderfederberg, etc...
5. What is the hardest part about maintaining Mirabib?
6. How costly is maintenance?
7. Any idea on how much picnic tables, braai pits cost?
8. You need a permit to travel the roads, why?
9. How carefully can you monitor permits?
10. Do you check for permits?
11. You need a permit to travel the roads, why?
12. Does this fee completely cover your costs?
13. Any way to put site on permit application?

The experts' answers to these questions helped us develop a low maintenance infrastructure and 3-year budgeted management plan that can be used at the Mirabib Campsites.

## Appendix E: Interview Protocol for Dominic du Raan: Director of Journeys Namibia

To learn about successful operations and marketing plans in Namibia, we interview management at Journeys Namibia: a company that specializes in the management and marketing of lodges and campsites throughout Namibia, including Gobabeb Research and Training Centre. We asked the following questions:

1. How does Journeys run? If we came in here as tourists how would you help us?
2. What are people looking for in a successful campsite?
3. How do you deal with bookings of lodges and campsites?
4. What types of challenges do you face when marketing a location?
5. What is Journeys relationship with Gobabeb?
6. What are your thoughts on Mirabib?
7. Where does Mirabib fall short of your expectation of a campsite?
8. If Mirabib was up to par, do you think there may be a relationship with Journeys?
9. How can we make Mirabib successful?

## Appendix F: Interview Protocol for Sem Shikongo, Direction of Tourism, Ministry of Environment and Tourism

To gain an understanding of tourism in the Namib-Naukluft Park, we spoke with Sem Shikongo, the Director of Tourism at the Ministry of Environment and Tourism. We asked the following questions:

1. What is MET's goal for Namibian tourism?
2. What are the guidelines to assess if an activity has a high value to tourists and has a low impact to the environment?
3. How can you use Mirabib to achieve these goals?
4. What do we need to ensure that we keep in mind when creating recommendations?
5. We were told about a new growth policy to be implemented, what can you tell us about it?
6. What environmental policies do we have to adhere to?



## Appendix G: Interview Protocol for Chris Neakre, Topnaar Traditional Authority Liaison

To understand the relationship between the Topnaar people and tourism in the Namib-Naukluft Park, we interviewed Chris Neakre, a Topnaar Traditional Authority Liaison. We asked Chris the following questions:

1. Where are the Topnaar villages currently located? Do they move at all?
2. Do they have any history being in the Mirabib area?
3. Will they care about any changes at Mirabib?
4. Will an increase in tourism at Mirabib affect them in any way?
5. Do you think they would ever own the campsites?

## Appendix H: Interview Protocol for Titus Shuuya, a Welwitschia Researcher

To gain an understanding of the current status of the Welwitschia research in the area around Mirabib, we interviewed Titus Shuuya, a researcher at Gobabeb who specializes in Welwitschia. We ask Titus the following questions:

1. Where are the closest Welwitschia to Mirabib?
2. Are they in danger or a healthy population?
3. Would they be interesting for tourists to visit?
4. Would tourists visiting have any effect on the ongoing research?

## Appendix I: Interview Protocol for Derek Jacobs, Director of Blue Crane Safaris

To gain an understanding of Namibian tourisms, we interviewed Derek Jacobs, the director of Blue Crane Safaris. We ask Derek the following questions:

1. How does booking work?
2. What are people looking for when booking a trip?
3. Why do people choose one trip over another?
4. What is your main demographic?
5. Are there any trends between demographics and types of trips?

## Appendix J: Interview Protocol for Arnold Uwukhaeb, Acting Warden of the Ganab Station

To gain an understanding of the maintenance protocol and operations in the Namib-Naukluft Park, we interviewed Arnold Uwukhaeb: the acting warden of the Ganab Station. We asked the following questions:

1. Could you tell us about the Mirabib Campsites and the operations?
2. What are some common Mirabib problems?
3. Any ideas as to why people chose Mirabib?
4. How often do the toilets require maintenance outside of basic cleaning?
5. What about the actual pits? Do they require attention?
6. Do you make infrastructure on site?
7. How much cement is needed for a table?

## Appendix K: Email Transcript with Mr. Johan LeRoux

*Mr. Johan LeRoux, experienced rock climber and former NNP maintenance staff member, was contacted via email on April 13<sup>th</sup>, 2015. A reply was received on April 16<sup>th</sup>, 2015.*

Mr. Johan LeRoux:

Hi Katie,

I think it's a great idea with a lot of potential, especially if combined with the development of Bloedkoppie as a climbing area as well. In fact, there are many areas inside Namibia's protected areas that are absolutely mouth watering to climbers, e.g. the sandstone cracks of the Waterberg Plateau Park. Let's hope you get climbing at Mirabib past the conservatives and that the idea snowballs from there! Imagine a climbing trail that starts at the already established climbing areas on the Orange River, then on to the Fish River Canyon, followed by Naukluft, Mirabib, Bloedkoppie and the climber's mecca of the Spitzkoppe before finishing at Waterberg! Climbing in National Parks is commonplace the world over, just not in Namibia :-)

I worked in the NNP in the eighties, so it's been a while since I've looked at Mirabib. I seem to remember quite a nice wall on the western side but I don't know how climbable it will be. On granite, most if not all of the routes will be friction climbs (my apologies if you're a climber and know all of this!). This usually requires a climbable slab at ground level, rather than a bulging overhang, as you need body weight on your shoes in order to friction climb. The slab can be near vertical but without big bulges. I say "usually requires", because it may be an idea to position the anchors at an accessible point on top of the dome. Both climbers would then abseil (or rappel if they're American) to the start of the climb. This is often done on sea cliffs, but not on slabs. The main reasons are:

- 1) On a sea cliff route you (usually) abseil to a convenient ledge for the belayer to stand on. On a bulging slab the belayer would at best be at a semi-hanging belay. This gets hard on the ankles and hips after a while.

- 2) On a sea cliff route you are already at the top (by the anchors) to start with. On a slab it may seem a bit silly to scramble up the back to get to the top before abseiling to the bottom and climbing back up again.

Best would be to start at the bottom, climb to the top and enjoy the sunset!

It might also be possible to put up some routes inside the shelter if the rock isn't too brittle. These routes would be short but hard pumpfests!

The only environmental concern that I can think of, other than the impact of possible increased tourist numbers, is aesthetics. All routes on Mirabib would need to be bolted as there will be no chance of using traditional gear placements for protection. This means that a line of bolts and hangers will be visible on each route going up the face. These can easily be camouflaged by spraying them with clear lacquer and coating with sand before the lacquer dries. Chalk and or hand oil build-up which is an issue at many US sites (e.g. Joshua Tree) is unlikely to become a problem here, as chalk is seldom used on friction climbs and the traffic on the routes is likely to be low.

I'd be happy to do an on-site evaluation in exchange for accommodation and a park entry permit from Gillian.

Regards

[Return to Top](#)

## Appendix L: Email Transcript from Nina Martiz

*Ms. Nina Martiz, experienced architect, was contacted via email. A reply was received on April 22<sup>nd</sup>, 2015. It read:*

1. We have done campsites at Huab Lodge for a community, Gochas for the Village Council, Namib Rand for the Family Hideout, Tierpoort for a community, etc. We have also worked on several Lodges (Anderson's Camp, Ongava, Taleni Etosha, Kalahari Game Lodge, etc.) and various structures in protected areas. Have a look at our Facebook page (Nina Maritz Architects) in the albums for various projects. There might not be many campsites shown, but there are lots of projects using natural materials.

2. Very important – enough and large enough flat areas either in one large area or in terraces, where people can pitch tents or put out their camping tables. You can use stone gabions as low retaining walls to create levels. At about 400 to 500 mm high, these can act like benches, and at 760 to 1m high, can act like a counter.

3. Also, ensure large enough turning circle areas for the car, also so that they can back up to the fireplace /cooking/eating area to unpack.

4. For campsites you need to consider **services** as a priority: what are you providing or not providing, and make it clear to the potential camper what is provided or not (at Mirabib I am assuming you will not provide anything):

a. Water: None, or only a tap, add a shower? To provide water means a tank on a higher level and a pipeline to the campsite. How does the water get into the high tank? A borehole and a pump will be needed, or a regular visit by a tanker with on board pump. Not recommended for Mirabib.

b. If shower, will you add a donkey for hot water? If there is no attendant, don't add a donkey – the visitors mess it up if they have to make the fire in the donkey. A dry shower consisting of a shelter and a winched up galvanised bucket with a showerhead and stop-tap welded to the bottom, can be a good idea, so that people can put in their own water and shower in privacy. Natural stone paved floor for comfort (No cement). Speak to MET rangers whether this will be secure or will be stolen/ vandalised. If the latter, don't add the bucket.

c. Energy/ power (including fuel for fires): No solar for unattended campsites. Must people bring their own wood?

d. Toilet/ sewerage: A dry pit-latrine would be the best at Mirabib. Make sure it is downwind from the campsite, and that it is a Double Ventilated Pit Latrine, which can be swapped over when the first one is full). Make sure that it cannot be damaged by antelope scratching against it). A solid seat that cannot have things like snakes hiding behind the pedestal is a good idea. Door must have latch both inside and outside so that it cannot bang about in the wind when left open.

e. Waste disposal/ removal: I prefer if people are obliged to take away all their own waste, as it can be an extensive management problem.

5. Shading – make it as wide as possible and add some vertical shade above head height on the west side, as it is the low afternoon sun which is the most uncomfortable. Rainproof is not essential at Mirabib, as it rains so infrequently there. Sturdy supporting poles and stones kerbs that prevent people driving into the poles. A true luxury are some hooks where people can hang their torches, etc. overhead.

6. I am not a fan of concrete tables with seats, as concrete tends to break over time and bits and pieces of concrete become a pollutant on the site. However, if neatly and sturdily built, it can work. It is nice to have one surface to the side to pack out stuff and the table for preparing, setting out food and eating. (Look at our Fish River Canyon lookout for alternatives to Concrete tables and benches).

7. Nowadays people bring their own grids, so the fireplace does not need one (they tend to get nicked in any case). However, make sure that:

a. The fireplace is big enough for making a fire and then raking coals to the one side for braai as well as a tripod with kettle (campers want to boil water, braai on a grid and cook in a potjie all at the same time).

b. Make sure that there is enough space for people to sit around the fire and move away from the flames if the wind blows towards them.

c. Make sure that the fireplace is somewhat sheltered from the prevailing wind. A sturdy dry-stone or gabion stone wall about 300 to 500 mm high on one to 3 sides can do the trick.

d. Make sure that if they don't put out the fire properly, the fireplace is situated so that coals do not blow out and ignite the veld. (The winds can be pretty strong there).

8. Materials must be **STURDY**. Wind is your biggest enemy and secondly UV degradation and dryness. Most eco-friendly are materials from as close by as possible, closest to natural state as possible, recyclable.

a. Avoid cement if at all possible. It is durable, but will leave a mess in future (also high embodied energy).

b. Stone is really the only material you can use locally. You may not mine sand or stone in the Park, but you might ask MET for special permission to use loose stones from the site. Otherwise, collect stone from the side of the road where the graders have moved it. There is some good stone on the way to Utuseb (yes a little far from Mirabib, but not too bad). Ensure that you do not pick up conflict with the Topnaar community for collecting stone in their areas. To avoid cement, you can create gabion structures using diamond mesh fencing wire to make "baskets". Good for retaining walls as previously mentioned, as well as screen walls. Can also be support walls. Width to height ratio is NB as well being curved or taken around a corner (a flat single wall can easily fall over). See various FB projects for gabion use.

c. Apart from stone, there may also be timber stumps from the riverbed, such as Anaboom trunks, but check if the Topnaars do not have first rights to these. They can be used for benches and for columns if long and strong enough.

d. Sand from the riverbed can be used to even out flat campsite areas, as long as you protect the edges of these flat areas to ensure that the sand is not eroded away, otherwise it is of no purpose.

e. Columns & rafter structures –

i. Tanalith gumpoles (Available from Agra) which are not 100% enviro-friendly, as they are treated with CCA which contains arsenic, but is the best we have available. Lasts almost forever in the desert climate. You can embed the foot of a pole in a gabion structure with 4 short steel rods fixed across the bottom at right angles – we have a detail somewhere for it), rather than a cement footing.

ii. Steel frames last even longer – round hollow-sections welded together the best. See Fish River for what we did there – a little more creative than the usual 4 poles and a flat roof. Embed also in gabions. (See Twyfelfontein for raised gabion footings also acting as benches – effective protection against vehicle damage).

iii. You can also make gabion columns, but they would need steel poles as reinforcing in the middle in any case.

f. Shading, roofing –

i. NO shade-netting – it perishes and rips apart in the wind.

ii. Best is to use Tanalith fencing droppers / latte which are very hardwearing. Needs to be fixed VERY securely though (ditto wind). See Fish River.

g. Screening, non-loadbearing walls –

i. Tanalith fencing poles best.

ii. You can use shade net as a backing to the Tanalith poles on the inside of a structure to improve privacy, but it must be fixed between the poles and the main supports very securely, to prevent wind damage. (Details Kalahari Game Lodge & Taleni Etosha).

iii. Do NOT use reeds, as they deteriorate too fast in the desert environment, get brittle, break and blow away.

This is all I can think of now. If you have more questions, just carry on with the email. I will try to set up email on my tablet, but cannot promise.

Regards

Nina





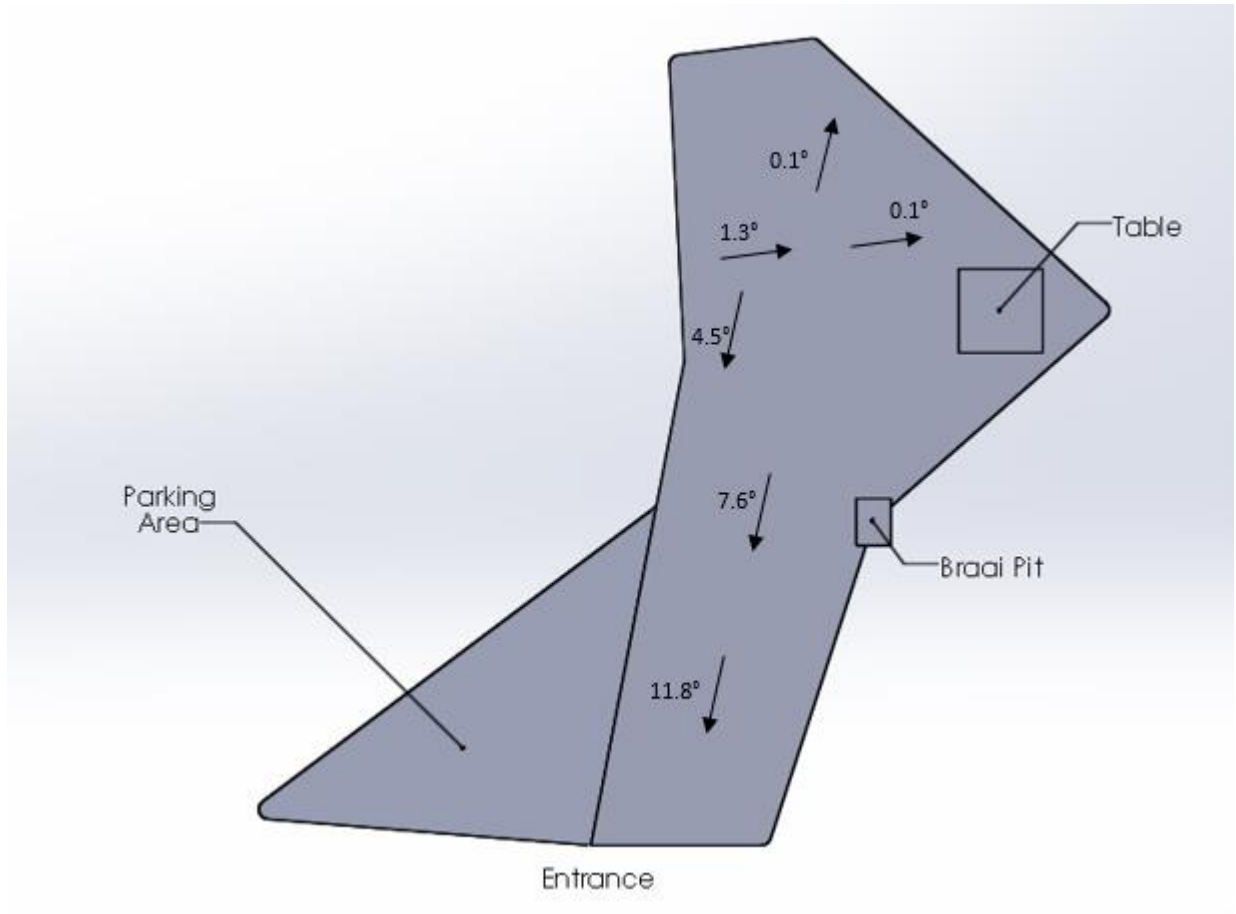

Figure 11: An incline map of campsite 1

Campsite 2

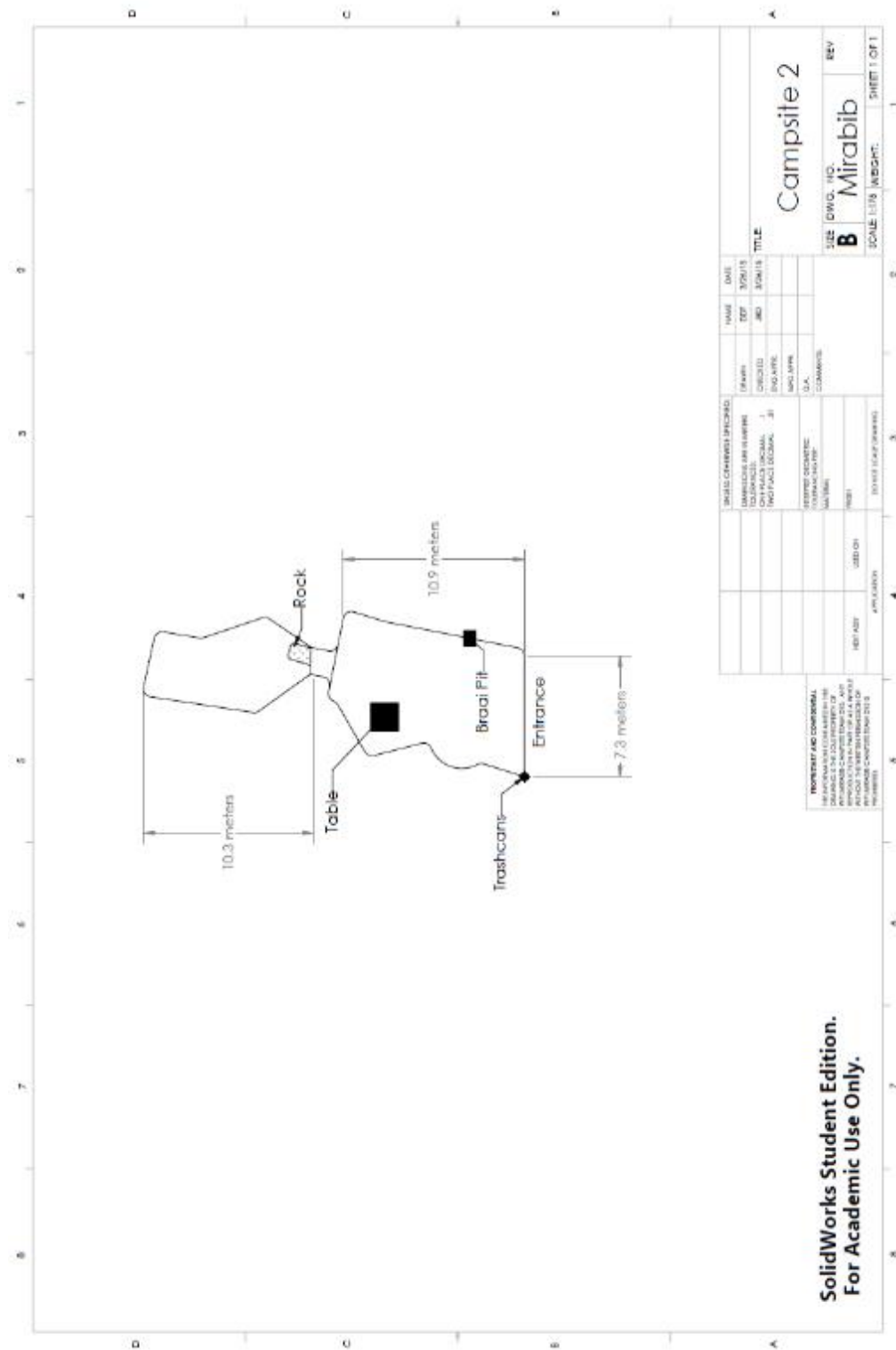

Figure 12: Site map of campsite 2

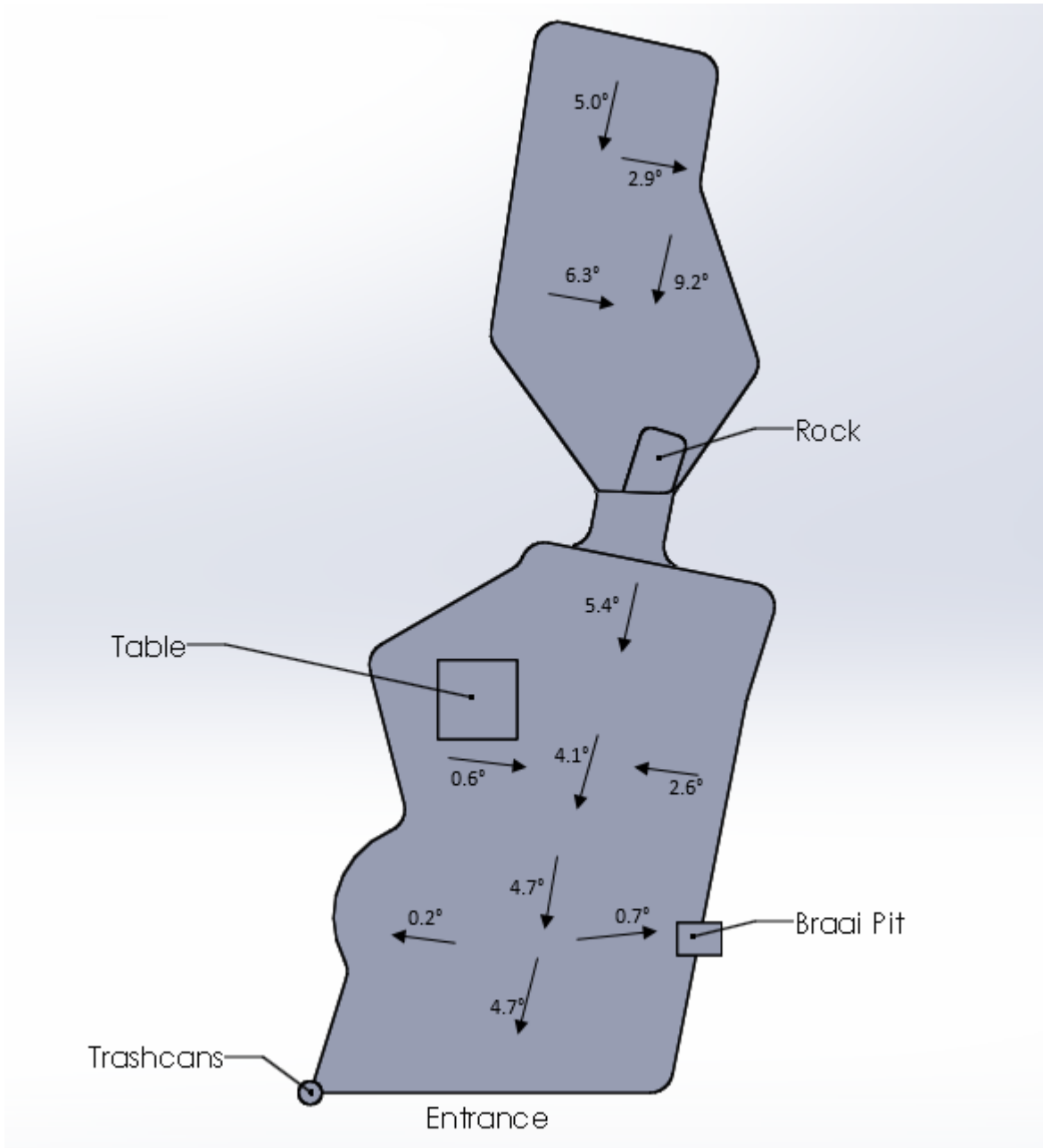

Figure 13: An incline map of campsite 2

Campsite 3

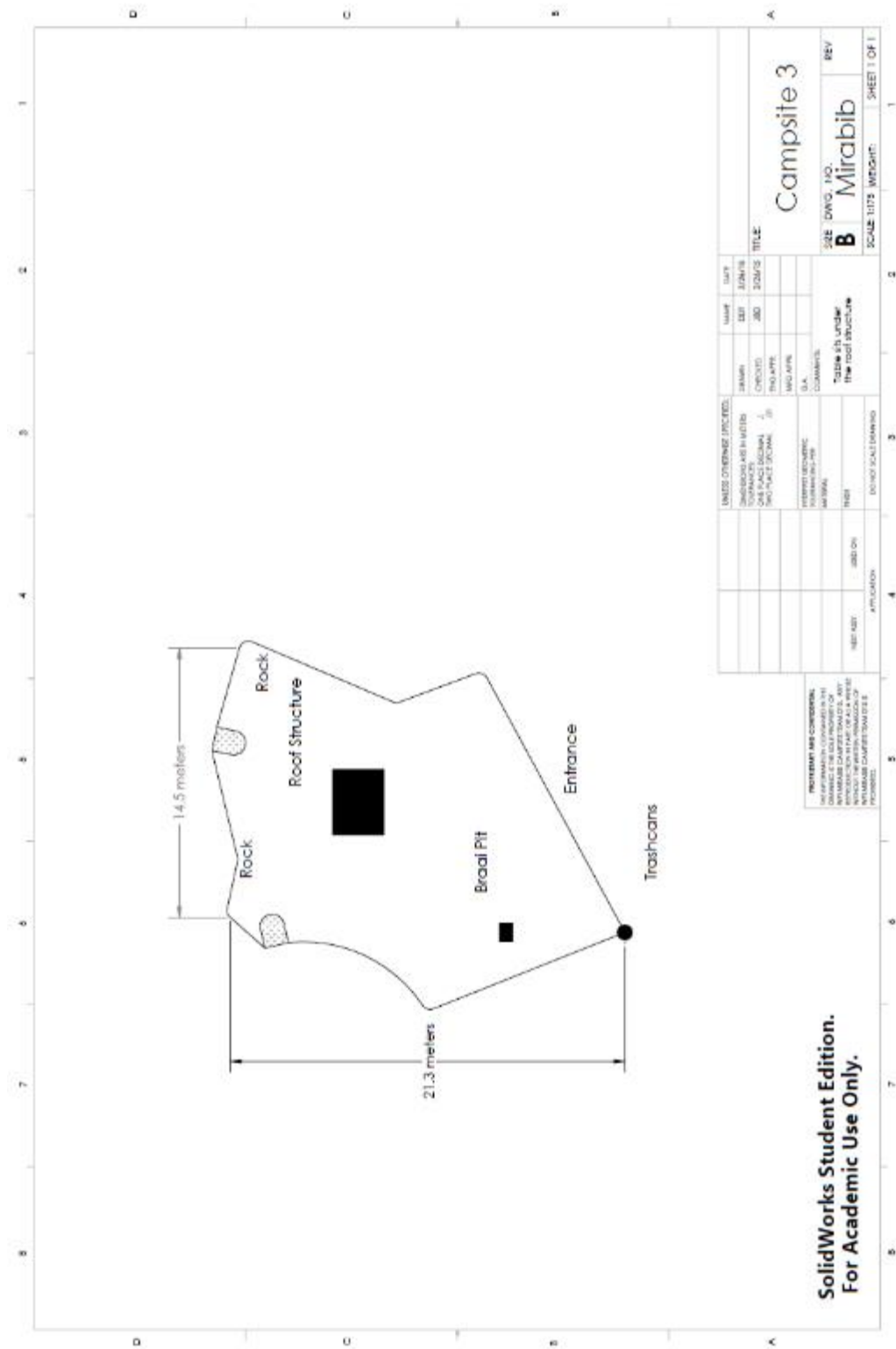

Figure 14: A site map of campsite 3

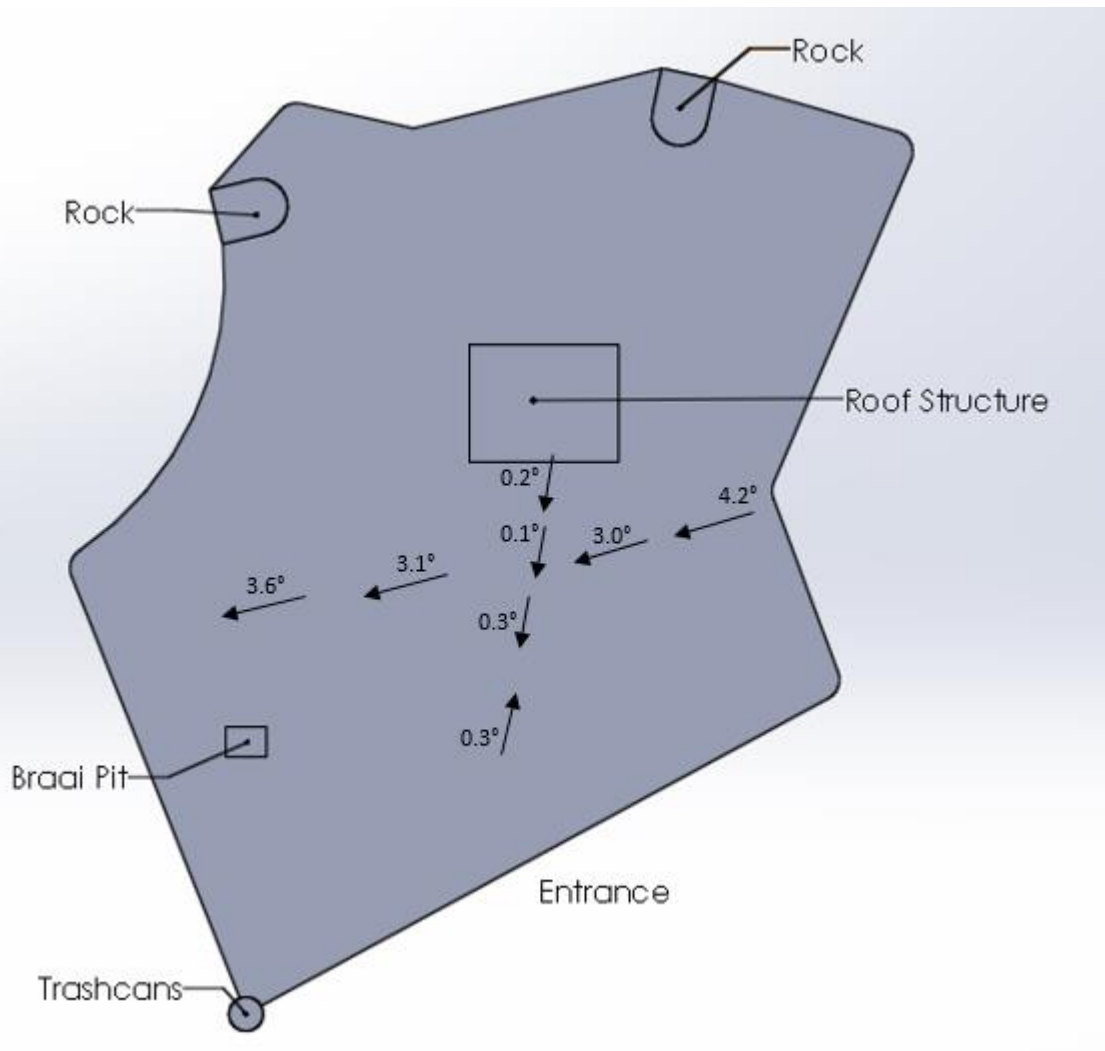

Figure 15: An incline map of campsite 3



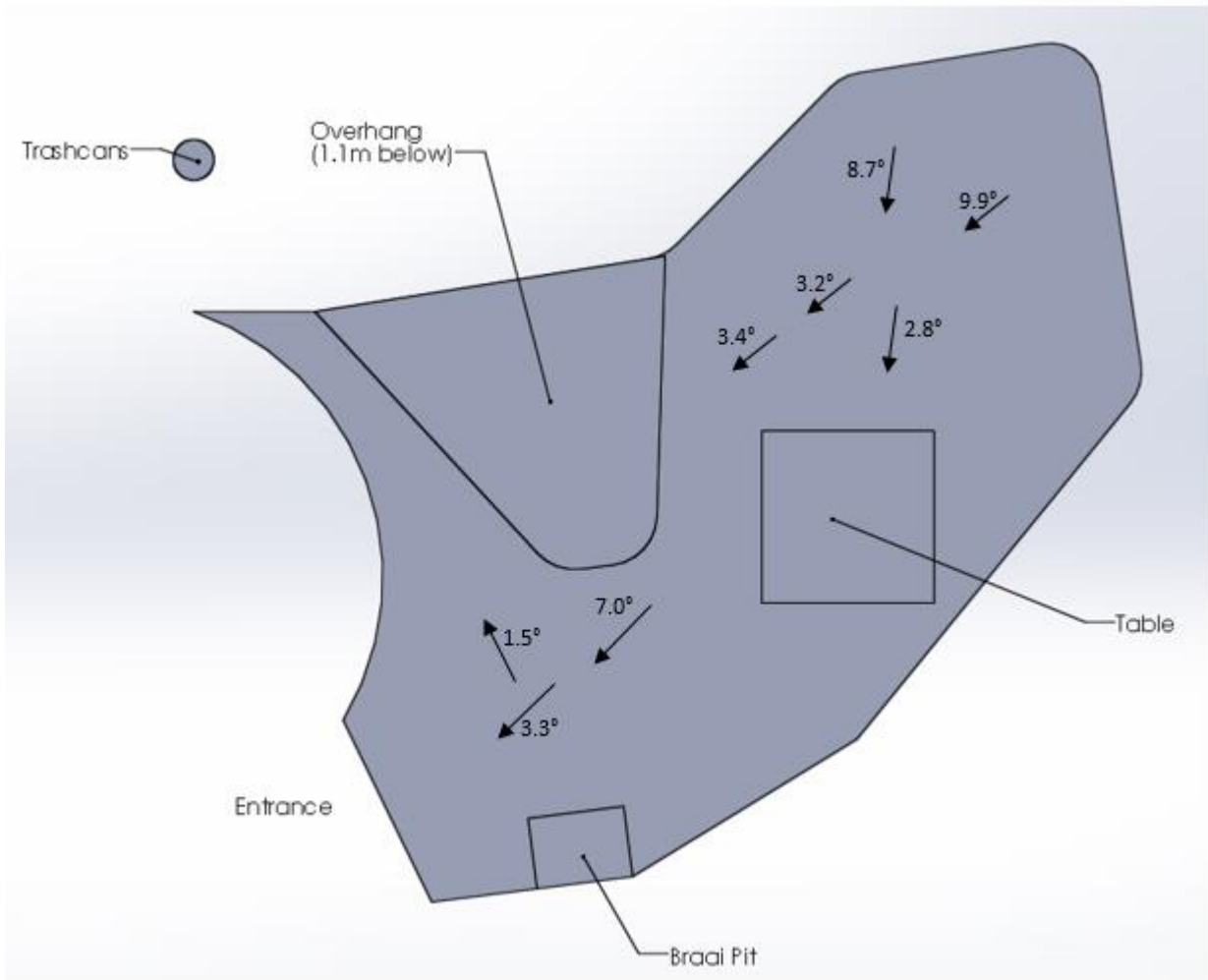

Figure 17: An incline map of campsite 4



Campsite 5

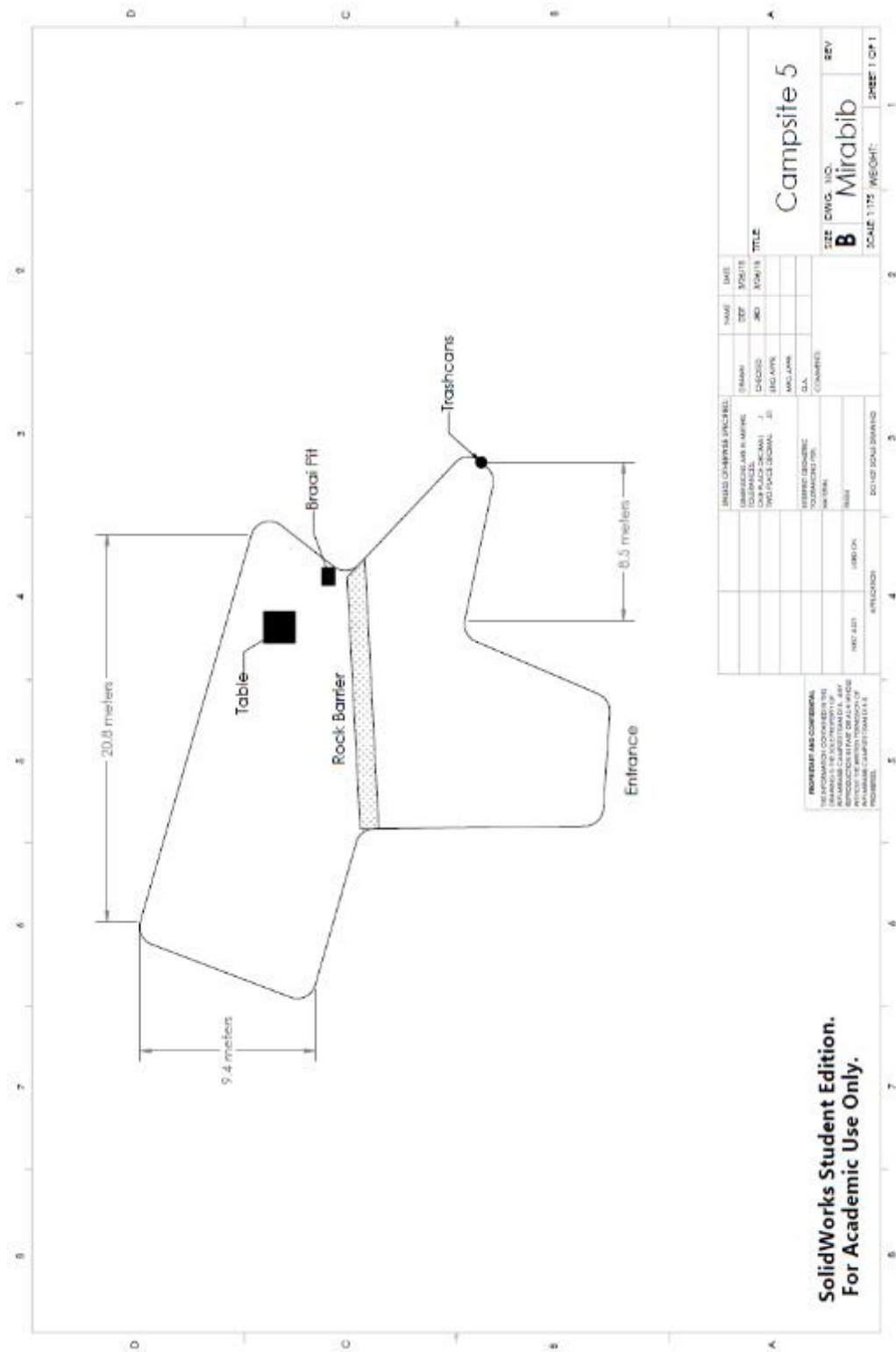

Figure 18: A site map of campsite 5

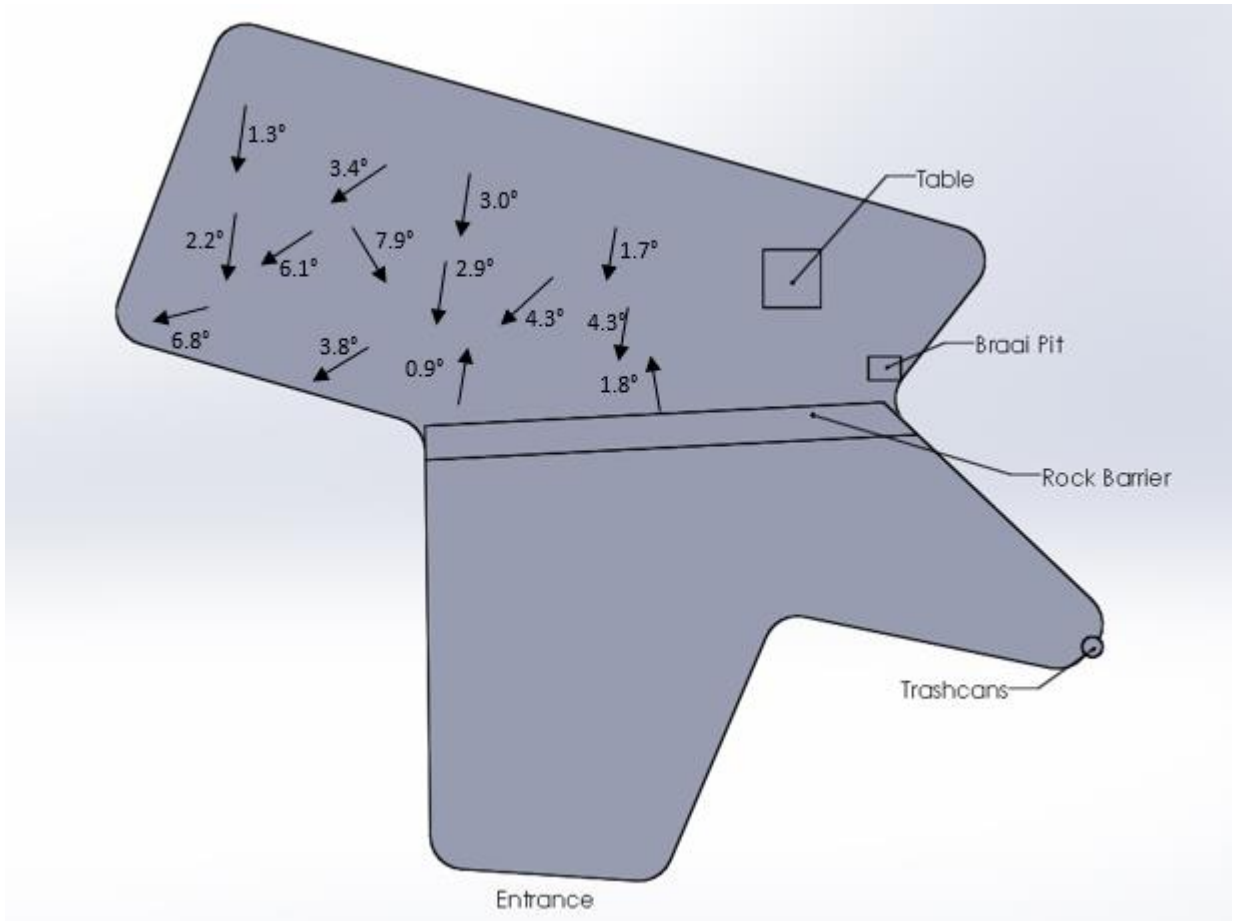

Figure 19: An incline map of campsite 5

Campsite 6

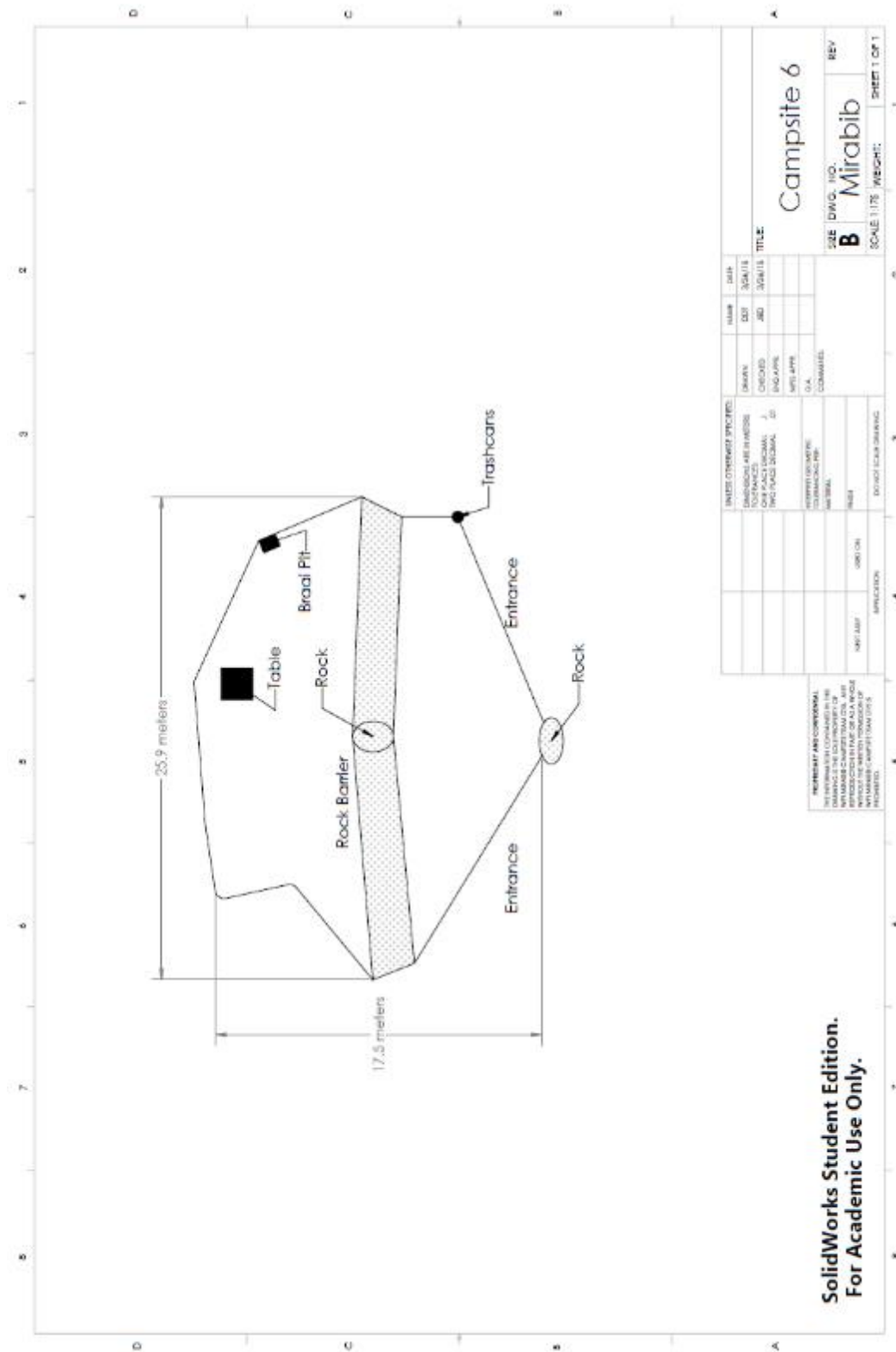

Figure 20: A site map of campsite 6

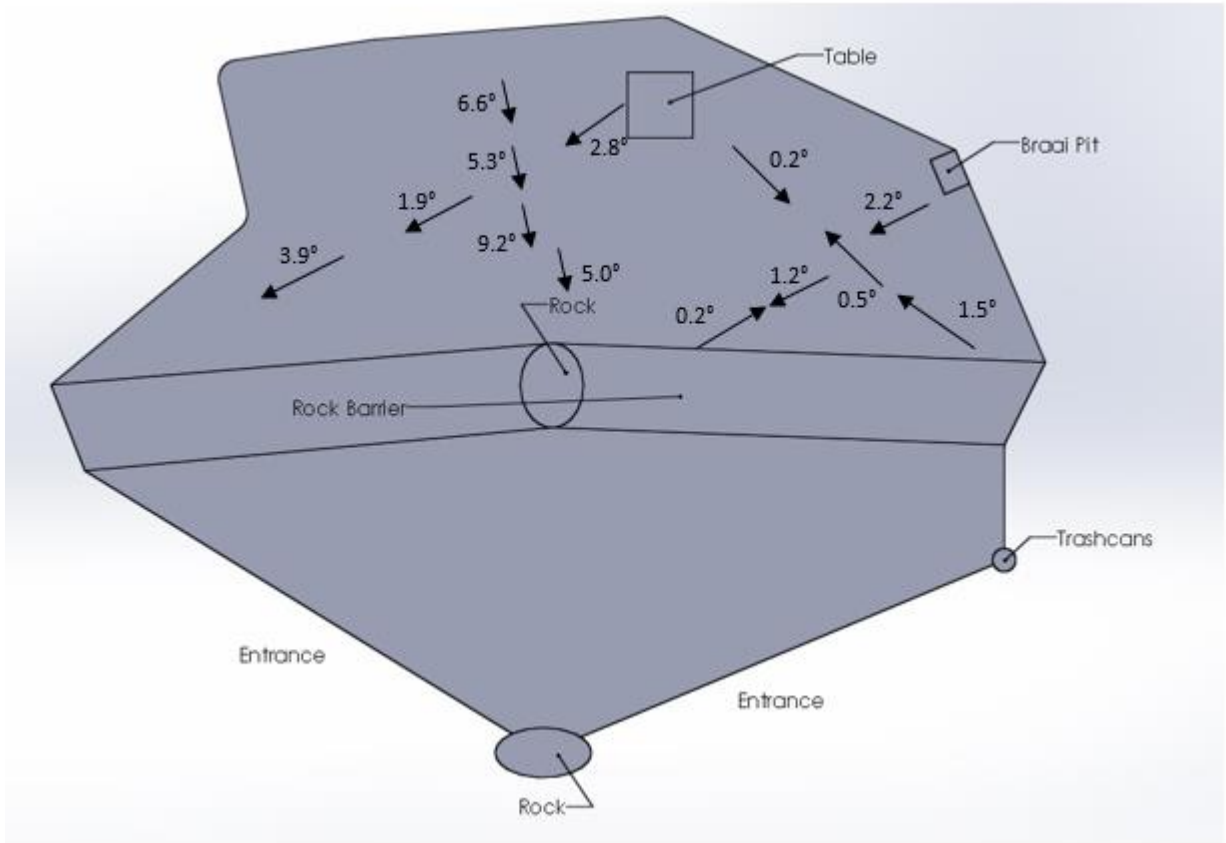

Figure 21: An incline map of campsite 6



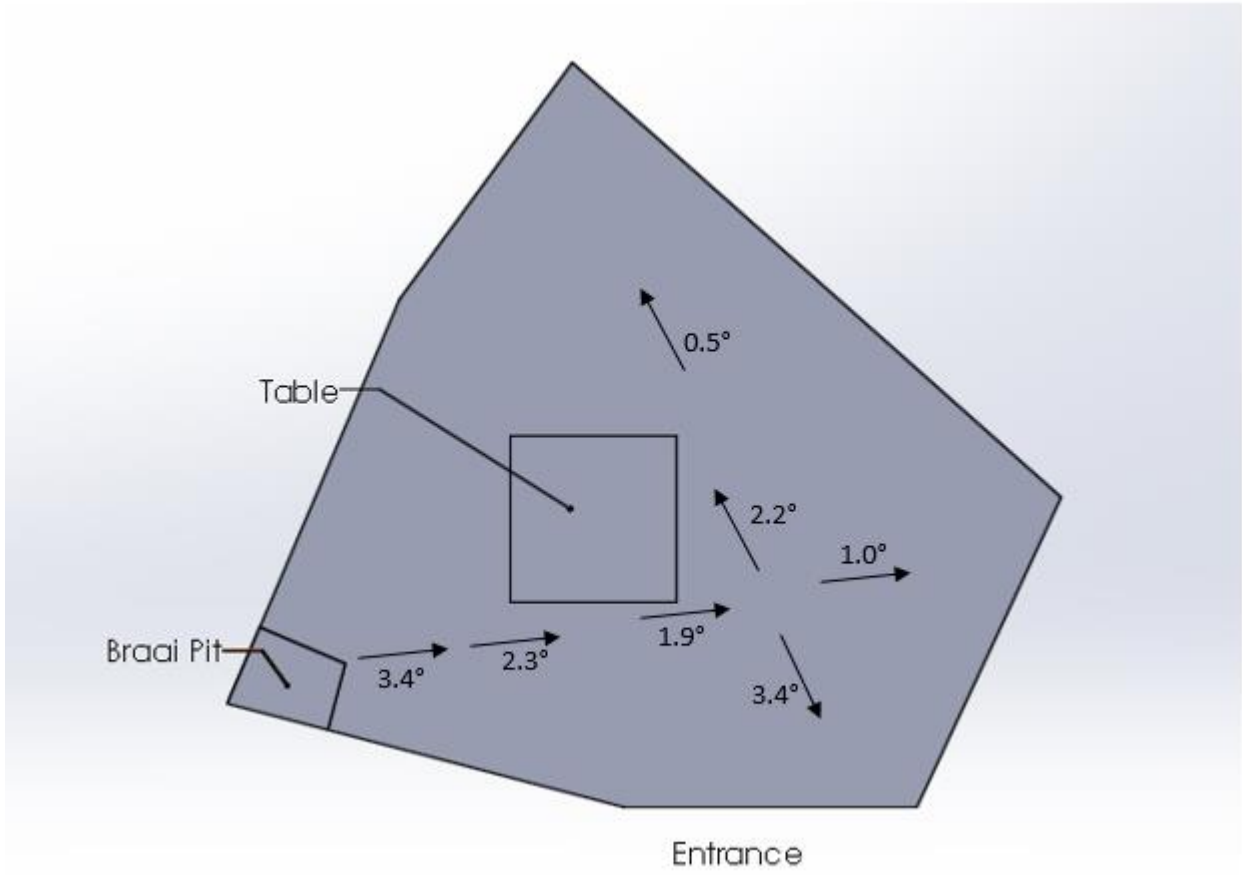

Figure 23: An incline map of campsite 7

## Appendix N: Sun/Shade Assessment

From the sun/shade assessment, we learned that 6 of the 7 sites are shaded most of the day. These sites are tucked in under the granite, which provides a shelter from the harsh sun, making the sites livable. Some do get some sunlight in the early morning or late evening, but mid-day when the sun is the strongest they will remain protected. Site 3 is an exception to this. This site is much less protected from the sun, and is in direct sunlight for much of the day. We found that MET had built a small shelter over the picnic table on this site to provide shade to visitors. We also found that this shelter was quite small and only effective when the sun is at certain angles.

This information is important to us because as we moved forward to make suggestions to improve the campsites, it was important to know where the sun shines throughout the day. Maximizing use of natural shade will make the sites more desirable for visitors.

A study was completed to look at the different campsites and how much shade they had throughout the day. Figures 24-30 show each campsite at 9am, 12pm, 3pm, and 6pm on 24 March, 2015.



Figure 24: Sun/Shade Assessment for Campsite 1

## Campsite 2



Figure 25: Sun/Shade Assessment for Campsite 2

## Campsite 3



Figure 26: Sun/Shade Assessment for Campsite 3



## Campsite 4



Figure 27: Sun/Shade Assessment for Campsite 4

## Campsite 5

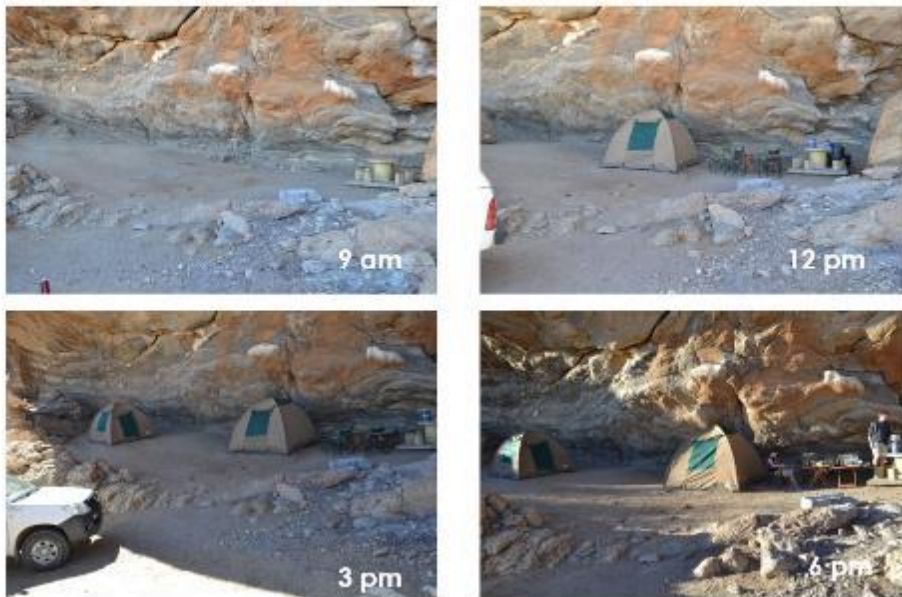

Figure 28: Sun/Shade Assessment for Campsite 5

## Campsite 6

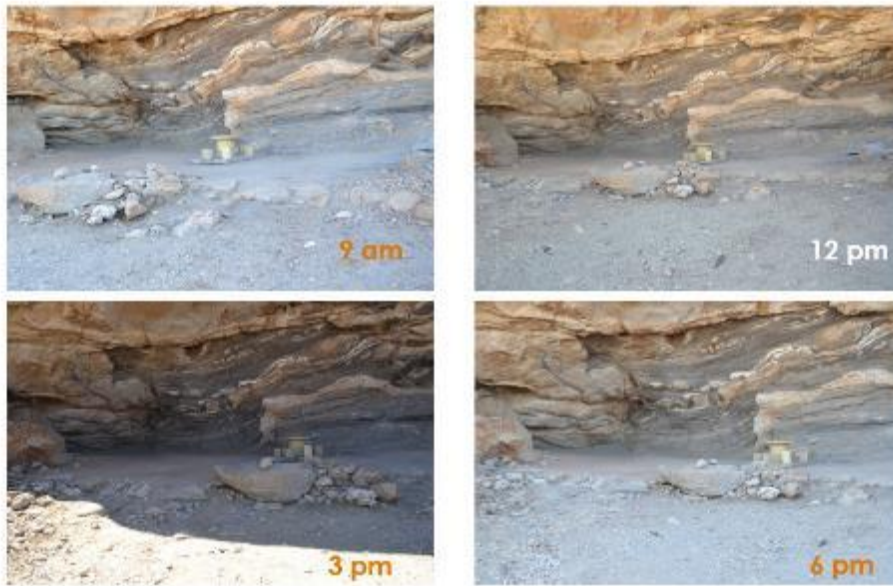

Figure 29: Sun/Shade Assessment for Campsite 6

## Campsite 7

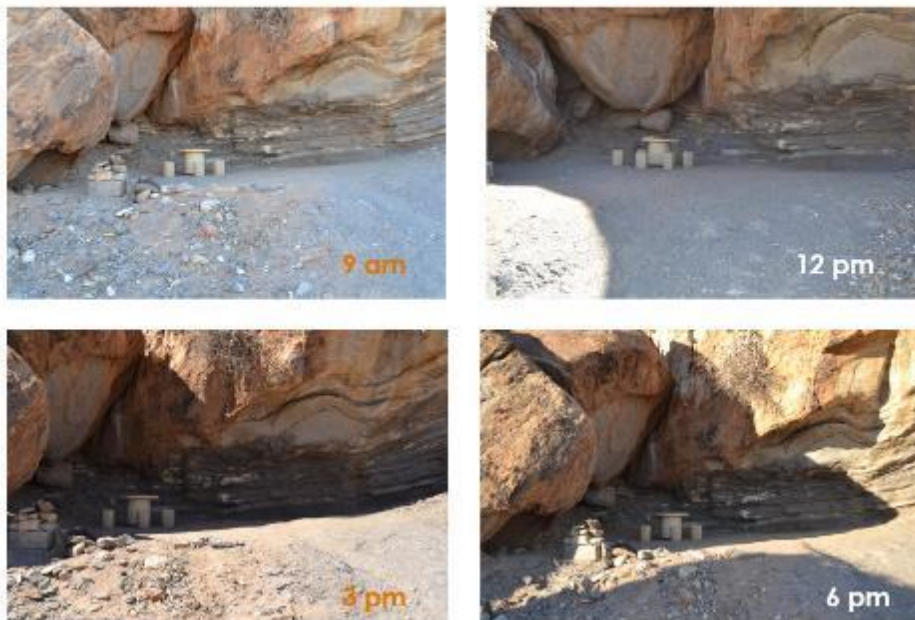



Figure 30: Sun/Shade Assessment for Campsite 7

Appendix O: Marketing Brochure Template



# Mirabib

Use this section to give a brief summary of the Mirabib Campsites. Give background about Mirabib. Also, this is where the appeal of the campsites is located. Describe the **remote and natural** environment. Continue to use key words such as **eco-friendly, sustainable, and unique**. These buzzwords will draw the attention of readers and convince them that Mirabib is a place they want to stay.



## MIRABIB CAMPSITES

Namib-Naukluft Park  
Erongo, Namibia



Northern Section Namib-Naukluft Park

**Please obtain overnight permit and driving permit from:**

**Ministry of Environment and Tourism Permit Office**

Windhoek: Corner of Dr. Kenneth Kaunda St & Robert Mugabe Ave

Walvis Bay: 643 Heinrich Baumann St

Swakopmund: Corner Bismarck St & Sam Nujoma Ave

Park: Sunrise to Sunset 7 days a week





Figure 31: Marketing Brochure Template Side A



**Go for a nature walk:**

*Outline the nature walk the has been created and say how it gives the visitor a chance to learn something new.*

**Start your day with the sunrise, and end with the sunset:**

*Describe the sunrises and sunsets in detail. Use them as a draw to stay. Use imagery so that readers can visualize it in their heads. This will create emotions and a want to come see it for themselves.*

**Take a scenic drive:**

*Introduce the drive.*

- **Zebra pan:** *Describe what Zebra Pan is and what there is to see.*
- **Hope Mine:** *Describe the Mine and why it is there.*
- **Homeb:** *Describe what Homeb is and what there is to see (mention Topnaar?)*
- **Gobabeb Research and Training Centre:** *Describe what Gobabeb is and what there is to see.*

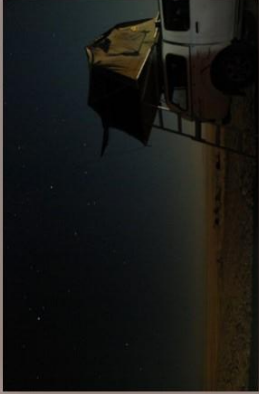

**Spend your nights stargazing:**

*Describe why Mirabib is an optimal place for stargazing. Give an example of a well known constellation. Again put emphasis on the remote nature around the campsites and use it as a tool for increasing appeal.*

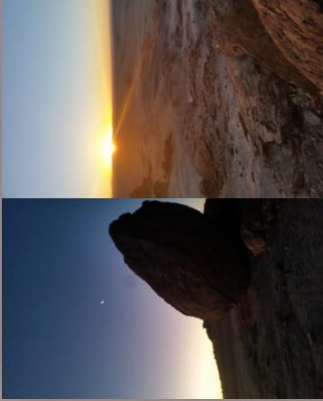



Figure 32: Marketing Brochure Template Side B

## Appendix P: Printed Publication Details

Table 1: Table Detailing Paper and Online Publications

Publication	What type of information does it contain?	What to advertise in this publication?
<b>Go!/Weg! Magazine</b>	Travel and outdoor magazine popular in South Africa. Contains information on destinations, photographic portfolios, and possible travel itineraries.	Advertise the Mirabib campsites as a place to stay with particular emphasis on the remoteness and solitude of the area. Promote Mirabib as an affordable place to stay for any nature lover. Included photographs that depict the inselberg, the night sky, and the views. Reach out to previous tourists and ask them to write blog posts about their experiences at Mirabib to share in the magazine.
<b>Getaway Magazine</b>	A South African based travel magazine. Contains information on travel destinations and travel guides. Also, they offer travel packages complete with sample itineraries which can be booked online.	Give general travel information about the NNP. Highlight Mirabib as a place for remoteness and solitude. Be sure to include photographs. This article should be similar to Go! Magazine article.
<b>Travel Namibia</b>	The only international travel magazine solely dedicated to Namibian tourism. Gives information about travel destinations and attractions. Also contains lists of places to visit based on different criteria (including budget friendly trips, camping, and Southern Namibia).	Advertise the central NNP as a place to visit. Give Mirabib as an option for budget friendly travel. Use the phrase, "Dunes like Sossusvlei" when describing the sand dunes along the Kuiseb. Highlight the remoteness of the Mirabib campsites as a main attraction, but give other attractions as well (from Chapter 5.4).
<b>Travel Africa</b>	Similar to Travel Namibia magazine but it advertises all of Africa instead of only Namibia. It gets more exposure internationally than Travel Namibia.	Advertise the central NNP as a place to visit. Give Mirabib as an option for budget friendly travel. Use the phrase, "Dunes like Sossusvlei" when describing the sand dunes along the Kuiseb. Highlight the remoteness of the Mirabib campsites as a main attraction, but give other attractions as well (from Chapter 5.4).
<b>Africa Geographic</b>	An African magazine that focuses on geography, culture and nature. Contains in depth information on specific areas and gives general information on each.	Use Africa Geographic to give information on the NNP. Show that there are other interesting attractions in the park besides Sossusvlei. To highlight the geology and history of the area, use Mirabib as an example. Discuss the history of the local people in the area. Describe the desert adaptations that have helped them survive in an arid climate. Include lots of pictures of the area.

## Appendix Q: Infrastructure Benchmarking

### Tables

Table 2: Advantages and Disadvantages of Different Table Designs

Design	Advantages	Disadvantages
Design I	One piece design, durability	Difficulty of repair with one piece design
Design II	Ability to replace one seat rather than the entire table unit	Multi-material design: easier for visitors to steal components of table
Design III	Simplicity of design, attached to base	Multi-material design: durability lost with multiple pieces
Design IV	One piece design, durability	Difficult to repair due to one piece design

- I. Figure 33 shows a “vandal resistant” table. The table is made of a concrete mix and reinforced with a rebar grid, making it difficult to damage the structure of the table. This table also consists of one single piece, making it difficult to steal.



Figure 33: One-Piece Reinforced Concrete Table Design (Outdoor Creations, 2015)

- II. Figure 34 shows another type of “vandal resistant” table. This table is also made of steel reinforced concrete, but features four separate seats rather than two benches. The table itself still consists of one solid piece, but in this design, if one seat were broken off a replacement seat could be attached rather than having to replace the entire table unit.



Figure 34: Reinforced Steel Table with Individual Seats (Belson, 2015)

- III. Figure 35 shows a simple, sturdy table design. Although the materials for this table are not appropriate to the desert environment, the design could be applied using proper materials. The steel frame is held steady in a concrete base, making the table secure. The wood seats and table could be replaced by either concrete or steel, to make the table sturdier.



Figure 35: Table With Steel Frame Embedded in Concrete (Interempresas, 2015)

- IV. Figure 36 shows a round table that is similar to Table I. It is made of the same concrete mix with rebar enforcements. The single piece design adds to the table's durability



Figure 36: Round Reinforced Concrete Table (Outdoor Creations, 2015)

## Toilets

Table 3: Advantages and Disadvantages of Different Toilet Designs

Design	Advantages	Disadvantages
<b>Pit Toilet</b>	Simple design	Mixing of solid and liquid waste creates a strong odor
<b>Otji- Toilet</b>	Separation of liquid and solid waste reduces odors and dried solid waste can be used as fertilizer	Special system needed, needs maintenance twice a year
<b>Eco-Toilet</b>	Separation of liquid and solid waste reduces odors and dried solid waste can be used as fertilizer	Need to install special toilet bowl

Figure 37 shows a pit toilet with a ventilation system to reduce odors and create a shelter protected from animals.



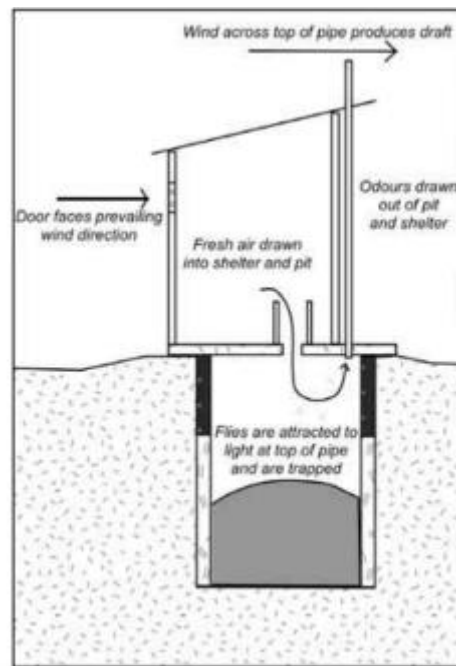

Figure 37: A Pit Toilet Structure (Center for Appropriate Technology, 2015)

The design features a vertical pipe with the pipe opening covered by a fine insect mesh. When wind passes over the top of the pipe, it creates a draft that sucks air out of the interior of the toilet area and out into the open air. The vertical pipe is made without bends so that the light from the outside is visible at the pipe end inside the structure. The light draws the flies up to the top of the pipe where the insect mesh blocks their escape, resulting in their eventual death.

The Otji-Toilet is shown in Figure 38. This toilet design features the separation of solid and liquid waste. There is a perforated container under the toilet pot, which allows the liquids to filter into a separate tank while the solids remain in the first tank. The liquids then filtrate into the ground while the solids remain in the tank. The design also features a drying portion of the tank. When the solid tank is filled up, the solid waste can be moved to the drying area using a hook, while the original container continues to collect additional solid waste.



Figure 38: The Otji-Toilet in Namibia (Eco Solution, 2015)

The eco-toilet (Figure 39) also utilizes the separation of waste technique, a specially designed toilet bowl. In the eco-toilet separates the waste in the toilet bowl, prior to the mixing that occurs in the tank. The bowl uses a filtration system that directs the liquid to the ground for dispersal. The solid waste is then contained in the tank. By preventing the waste from mixing, the solid waste will degrade and not need to be removed, therefore, no maintenance is required.



Figure 39: The Eco-Friendly Toilet (Eco Solution, 2015)

### Braai Pits

Table 4: Advantages and Disadvantages of Different Braai Pit Designs

Design	Advantages	Disadvantages
Large Braai Pit	One piece design discourages theft and	Bulky and expensive

	vandalism, reinforced to increase lifetime	
<b>Low Profile Braai Pit</b>	One piece design discourages theft and vandalism, reinforced to resist cracking	Smaller design limits capacity

The barbeque shown in Figure 40 utilizes a sturdy structure. The entire braai pit only contains one piece, making it difficult for tourists to steal or damage. The grill structures are laser cut, not welded, reducing the chance of failure. The body of the grill is made of reinforced concrete, adding to its resistance to vandalism.



Figure 40: A Large Braai Pit (Outdoor Creations, 2015)

Figure 41 shows a lower profile braai pit. This braai pit also only contains one piece, making it resistant to theft and vandalism. The material is a steel reinforced concrete. The grate is laser cut steel, reducing the tendency for the grate to degrade from the heat of many fires.



Figure 41: A Low Profile Braai Pit (Outdoor Creations, 2015)

## Trash Cans

Table 5: Advantages and Disadvantages of Different Trashcan Designs

Design	Advantages	Disadvantages
<b>Oil Drum Lid</b>	Reuse current can, keeps animals out, discourages placing in large bags or rocks	Lid can be removed
<b>New Cans With Small Opening</b>	Discourages placing in large bags or rocks	Cannot burn trash, animals can still get in

Figure 42 shows a lid that can be fit to a standard oil drum. This metal dome-topped lid is more sturdy and durable than the alternative plastic lid. The spring opening flap will prevent small animals from accessing the trash and causing environmental damage.



Figure 42: Simple Trashcan Lid (Grainger, 2015)

The trashcan in Figure 43 has a smaller opening than an oil drum. The finish is a reinforced resin that resists damage and vandalism. The interior can is made of heavy steel for durability and stability. The smaller opening may discourage tour operators from placing large bags and rocks into the trashcans.



Figure 43: Trashcan with a Smaller Opening (Global Industrial, 2015)

## Level Ground

Table 6: Advantages and Disadvantages of Flattening Campsites and leaving them as they are

Design	Advantages	Disadvantages
Flatten Site	Flat areas for tent	Ruin natural landscape
Leave Natural Landscape	Preserve natural landscape, sites still okay for campers with tents on roof of car	Difficult to pitch tents

Leveling of sites can be done by terracing with a retaining wall. This was done to create campsites at Gobabeb. One of these leveled sites can be seen below in Figure 44.



Figure 44: Leveled Gobabeb Campsite

## Showers

Table 7: Advantages and Disadvantages of Different Shower Designs

Design	Advantages	Disadvantages
<b>Basic Donkey Shower</b>	Clean campers, designated shower space	Expensive to install and maintain, poor temperature control
<b>Advanced Donkey Shower</b>	Clean campers, designated shower space	Expensive to install and maintain, many things can break
<b>Solar Bag Shower</b>	Inexpensive to install and maintain, clean campers	Campers need to have their own bag, soap residue into environment, no temperature control
<b>No Shower</b>	No water needed, no soap into environment	Many campers want showers

Figure 45 shows a donkey shower consisting of a water tank directly heated by fire. This design includes a cold inlet and a hot outlet, both attached to a water tank. The fire built beneath the tank heats the water, but leaves little room for temperature control.

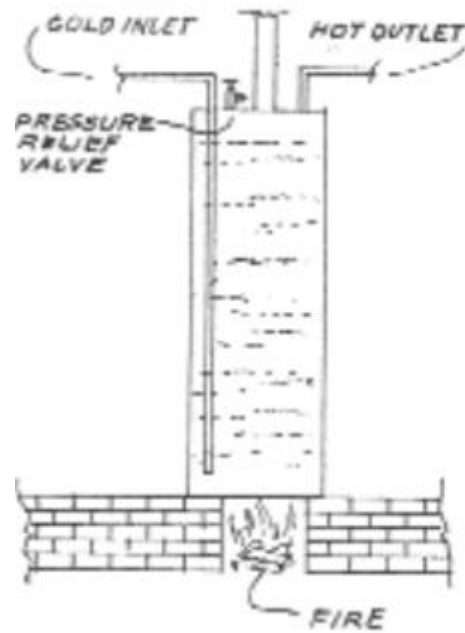

Figure 45: A Basic Donkey Shower (Fallick, 2015)

Figure 46 shows a more complicated design, but one that follows the same idea. This shower design includes insulation to improve the heating speed of the water. In this design, the water circulates through the tank and water jacket until the insulated heat riser heats it. Once the water reaches the desired temperature, it exits the tank for use.

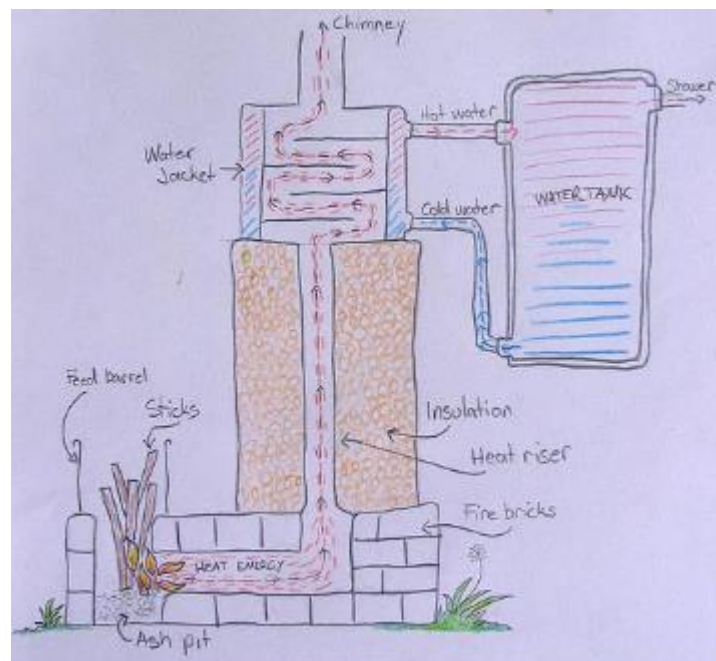

Figure 46: A Complex Donkey Shower (The Permaculture Research Institute, 2015)

Solar bag showers are also common in Namibia. Unlike the donkey shower, there is no need for a fire to heat water, because energy from the sun is captured and used. This means that the user

must put their bag out in the sun and wait for it to warm up, and then must use the water before it cools. Solar bags are simple to use, because all that is required is to hang the bag of water in the sunlight and wait for it to warm up. Figure 47 shows a solar bag shower.



Figure 47: A Solar Shower Bag (Walmart, 2015)



## Appendix R: Detailed Infrastructure Information

Raw material costs for infrastructure were obtained from [www.mcmaster.com](http://www.mcmaster.com). Although these costs for raw materials are for the US, this research gave us an approximation of new infrastructure costs in Namibia.

### Recommendations:

#### *Trashcans*

**Install a cover to the existing trashcans with a sign that educates users about proper trash disposal.**

The total estimated material cost for this design is N\$2,400 per trashcan lid. Detailed costing information can be found in Table 8.

This design addresses two issues:

#### 1. *Animal activity*

**Problem:** The trashcans have no lids, allowing scavenger animals to pick at the trash and spread it around the campsite.

**Solution:** The lid prevents animals from picking at the leftover food in the trashcans, which eliminates the opportunity for trash to blow into the desert plains.

#### 2. *Trash buildup from tour operators*

**Problem:** While driving by the campsites, tour operators clean out their tour buses and dispose of their tour group's trash, quickly filling up the campsite trashcans.

**Solution:** A laminated paper sign located on the lid describes the rules for proper trash disposal and the effects it has on park maintenance staff.

Table 8: Costing Information for Trashcans

	USD	NAM
Tops	\$200.00	\$2,358.00
<b>Per Trashcans</b>	<b>\$200.00</b>	<b>\$2,358.00</b>
<b>Total: 10 Trashcans</b>	<b>\$2,000.00</b>	<b>\$30,536.10</b>

Figure 48 shows an existing product that satisfies our need directly.

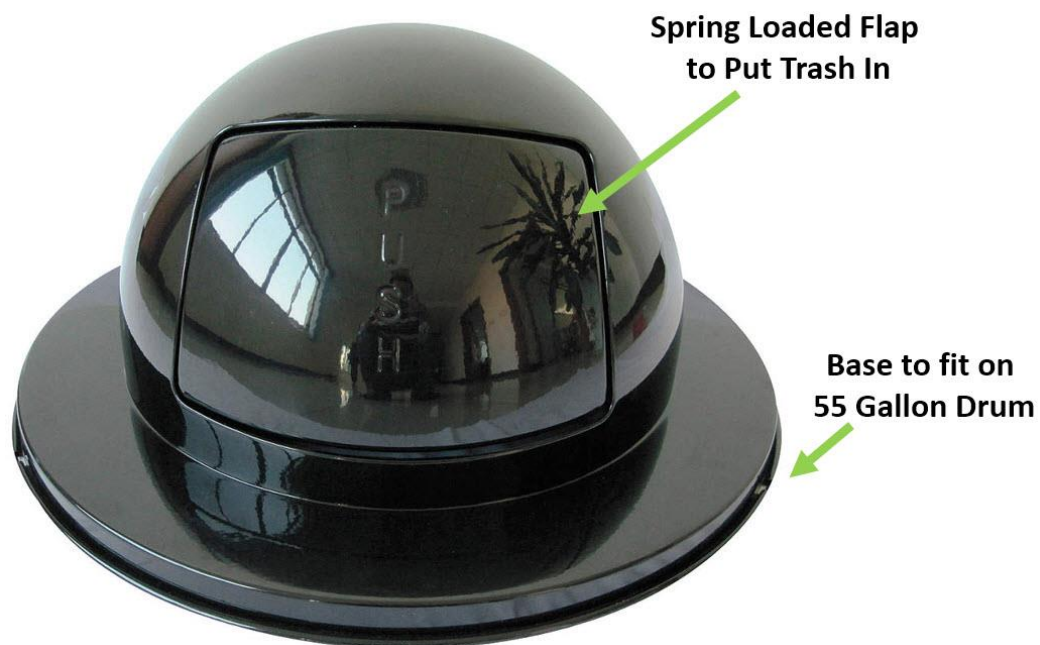

*Figure 48: Proposed Trashcan Lid*

It is a dome-topped lid for a 100-liter drum. The trashcan has a spring-loaded flap that the visitor presses on to open, and then places the trash inside. By using an existing product, the cost is reduced. Additionally, the lid can be placed on the existing trashcans, which saves the cost of buying all new trashcans. The spring-loaded feature makes it so that animals cannot get into the trashcans. The sign in Figure 49 will be placed on the trashcan to educate visitors about proper trash disposal.



Do you really need to throw that away?!?

Could you carry it out with you?!?

The nearest MET station is over 80km away, making it extremely difficult to dispose of trash. An overflowing trashcan harms animals and the environment nearby. Help us keep Mirabib clean!

Figure 49: Educational Sign to Place on Trashcans

## Shower

**Install a solar shower bag hook area to increase visitor comfort.**

The total estimated material cost for this design is N\$ \$2,200. Detailed costing information can be found in Table 9.

This design addresses two issues:

### 1. Running water

**Problem:** There is no running water at Mirabib.

**Solution:** The visitors use their own water supply and solar bag to take personal showers. Therefore, visitors can take showers without needing a water source at Mirabib.

### 2. Visitor Comfort

**Problem:** There are no shower facilities at Mirabib.

**Solution:** Since many tourists own personal solar shower bags, providing them with a designated area and infrastructure to hang their solar shower bags improves comfort.

Table 9: Costing for Showers

	USD	NAM
Hook	\$25.00	\$294.75
Rope	\$10.00	\$117.90
Rope Hook	\$150.00	\$1,768.50
<b>Per Shower</b>	<b>\$185.00</b>	<b>\$2,181.15</b>

Total: 2 Showers	\$370.00	\$4,362.30
------------------	----------	------------

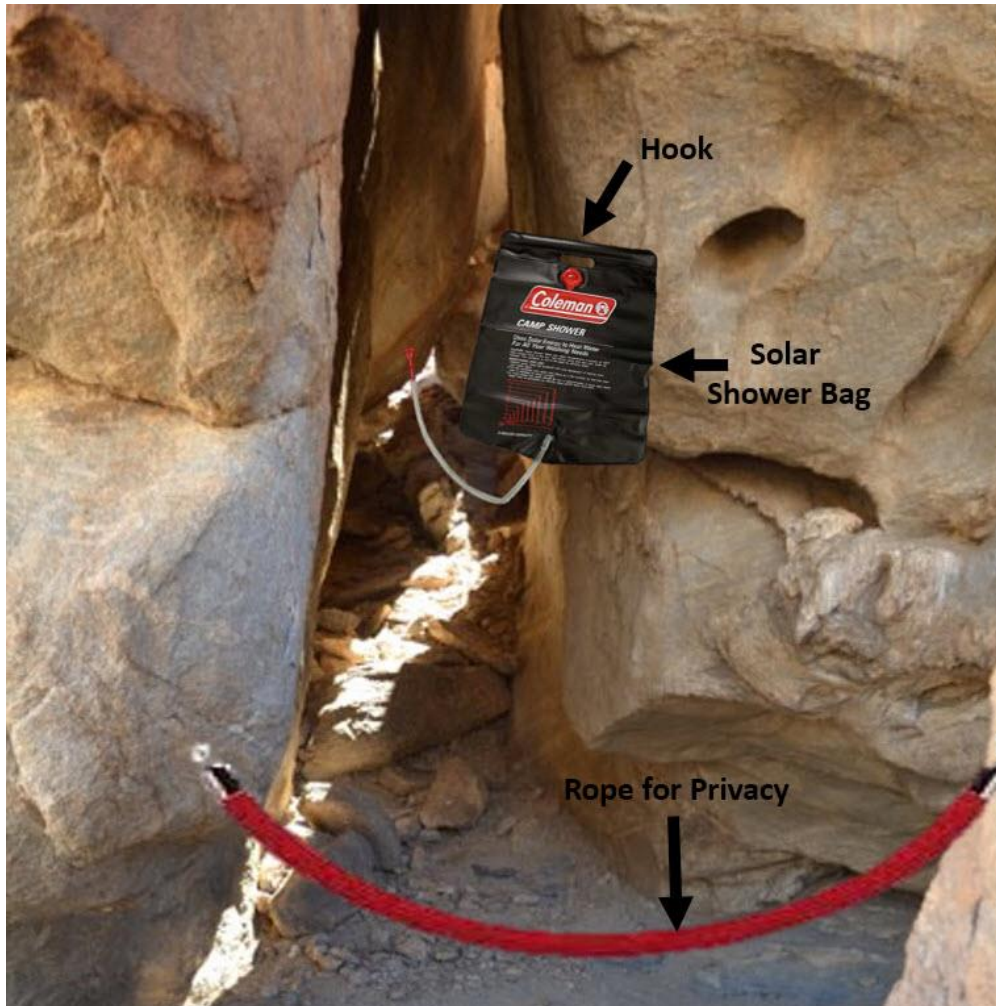

*Figure 50: Shower Location within Natural Rock Structures*

As can be seen in Figure 50, the design utilizes the natural rock formations. The rocks provide natural privacy to the visitor, while creating a pretty shower location. A hook is fastened to the rock where the visitor places their solar bag out in the sun to warm. Then, when they are ready, they bring their solar bag shower to the showering area. The bag is then hung from the hook to make a more comfortable shower for the visitor. A rope is used to indicate to other visitors that the shower is occupied. The rope is placed a distance away so that the other visitors know that someone is using the shower before they get close enough to see the visitor, ensuring privacy for the showering visitor.

## Signs

### Install signs to direct visitors to all seven campsites and necessary amenities.

The total estimated material cost for this design is N\$350 per toilet sign, N\$350 per campsite sign, and N\$6,500 for the entrance sign. Detailed costing information can be found in Tables 10-12. This design addresses four issues:

#### 1. *Visitors awareness of existing campsites*

**Problem:** Visitors do not know how many campsites are around the Mirabib inselberg.

**Solution:** A sign post at the Mirabib Campsites entrance indicates the direction of each site and the total number of sites. Visitors are more likely to camp at sites towards the back of the inselberg if the visitors knew the sites existed.

#### 2. *Trash distribution*

**Problem:** Campsite 3, the campsite nearest to the entrance, has the most traffic as shown by the overflowing trashcans.

**Solution:** The installation of a sign that indicates the number of campsites disperses visitors and decreases the trashcan overflow at campsites, reducing the frequency of maintenance needed.

#### 3. *Wear to campsite amenities*

**Problem:** The table at Campsite 2, the campsite nearest to the entrance, is missing three of six chairs. Due to higher traffic, the infrastructure at the more popular sites degrades faster than the infrastructure at the other sites.

**Solution:** Evenly distributing the visitors reduces wear on the infrastructure at more visited sites.

#### 4. *Visitors awareness of campsite locations and the nearest toilet facility*

**Problems:** Five of seven campsites had no sign indicating the direction to the nearest toilet facility. No campsites had a sign indicating the campsite number.

**Solutions:** A toilet sign at each site improves convenience for visitors. Signs that indicate the campsite number helps visitors know that they have reached their desired site.

Table 10: Costing for Toilet Signs

	USD	NAM
Toilet Signs	\$30.00	\$353.70
<b>Per Toilet Sign</b>	<b>\$30.00</b>	<b>\$353.70</b>
<b>Total: 6 Toilet Signs</b>	<b>\$180.00</b>	<b>\$2122.20</b>

Table 11: Costing for Campsite Signs

	USD	NAM
Campsite Signs	\$30.00	\$353.70
<b>Per Campsite Sign</b>	<b>\$30.00</b>	<b>\$353.70</b>
<b>Total: 7 Campsite Signs</b>	<b>\$210.00</b>	<b>\$2475.9</b>

Table 12: Costing for Entrance Sign

	USD	NAM
Entrance Sign	\$500.00	\$5895.00
Wood Sign Structure	\$50.00	\$589.50
<b>Total: 1 Entrance Signs</b>	<b>\$550.00</b>	<b>\$6484.50</b>

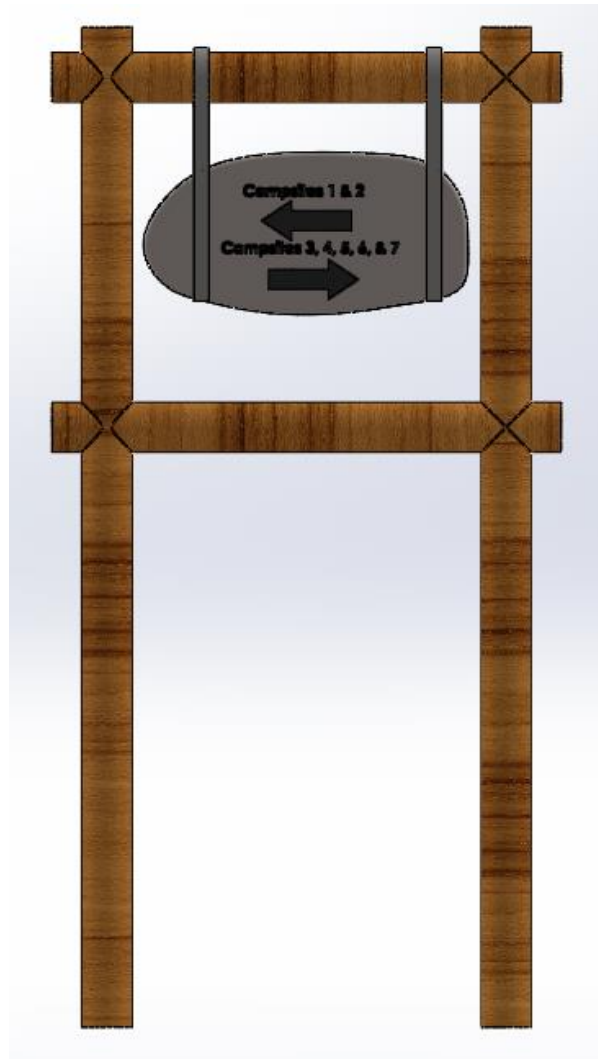

*Figure 51: Signpost at the entrance to the campsites.*

The sign is made of schist, which is natural to this environment. Using schist will help to reduce the cost of the sign while keeping a more natural look. The sign indicates which direction to turn to get to each campsite (Figure 51).

The sign is elevated using a wooden structure. The style is also consistent with the signs already existing at Mirabib (Figure 52).



Figure 52: Elevated Wooden Sign Structure

Additionally, at each site, there is a small rock sign indicating the number of the campsite (Figure 53).





*Figure 53: Sign Indicating Campsite Number*

The smaller size and lack of frame makes the sign cheaper to make, and minimizes modification to the natural appeal of Mirabib.

Figure 54 shows a toilet sign. Like the campsite number signs, this sign is made of material naturally found at the campsites.



*Figure 54: Toilet Sign*

A full design of sign location can be found in Figures 55-68.

## Campsite 1 Signs



Figure 55: Location of Campsite Number Sign on Campsite 1



Figure 56: Location of Toilet Sign on Campsite 1

## Campsite 2 Signs



Figure 57: Location of Campsite Number Sign on Campsite 2



Figure 58: Location of Toilet Sign on Campsite 2

## Campsite 3 Signs



Figure 59: Location of Campsite Number Sign on Campsite 3



Figure 60: Location of Toilet Sign on Campsite 3

## Campsite 4 Signs



*Figure 61: Location of Campsite Number Sign on Campsite 4*

Campsite 4 does not need a toilet sign due to the close proximity of the site to the nearest toilet.

## Campsite 5 Signs



Figure 62: Location of Campsite Number Sign on Campsite 5



Figure 63: Location of Toilet Sign on Campsite 5

## Campsite 6 Signs



Figure 64: Location of Campsite Number Sign on Campsite 6



Figure 65: Location of Toilet Sign on Campsite 6

## Campsite 7 Signs



Figure 66: Location of Campsite Number Sign on Campsite 7



Figure 67: Location of Toilet Sign on Campsite 7



## Main Entrance Sign



*Figure 68: Location of Sign at Main Entrance*

### Sign Board

Install an additional informational sign board to educate visitors about Mirabib.

The total estimated material cost for this design is N\$2,100. Detailed costing information can be found in Table 13. This design addresses two issues:

1. *Visitor knowledge about the surrounding area*

**Problem:** There is no materials to educate visitors about the area.

**Solution:** An informational board near the fork in the road by the entrance informs visitors about the geology, flora and fauna and interesting facts unique to the Mirabib area. This board reminds visitors that they are in a National Park, and politely asks them to please clean up after themselves.

Table 13: Costing for Education Board

	USD	NAM
Chromadek Education Board	\$124.15	\$1500.00
Wood Sign Structure	\$50.00	\$589.50
<b>Total: 1 Education Board</b>	<b>\$174.15</b>	<b>\$2089.50</b>

**Welcome to Mirabib!**  
The name "Mirabib" means "Hyena's Water."

**The Rock Dassie:**  
The African Elephant's closest living relative, the Rock Dassie, can be found at Mirabib. Rock Dassies poop in the same spot for their entire lives, and the layers of their poop, commonly seen around Mirabib, can be used to conduct research on the available vegetation.

**What is an Inselberg?**  
German for "Island mountain," inselbergs are large granite outcrops. Inselbergs like Mirabib are estimated to be up to 600 million years old.

**Did you know....**  
The opening scene of the 2001 film *Space Odyssey* was filmed here at Mirabib!

**You Are Here!**

**What plant is that?**  
The *Commiphora Saxicola*, or Rock Corkwood, pictured left, is commonly found in the cracks of Mirabib. The *Moringa Ovalifolia*, pictured above, can be seen in the gravel plains surrounding Mirabib.

**Help keep our park clean! Please pick up your trash!**

Figure 69: Sign Board

The signboard includes a map of the seven campsites to help visitors understand the layout of the campsites (Figure 69). It also includes fun-facts about Mirabib and has educational information. The signboard is made of chromadek with printed stick-on letters, which is sturdy enough to handle the desert environment, and cheap and easy to install (The Sign Shop, personal communication, 30 March 2015).

### Toilet

**Install an eco-friendly toilet that ventilates the waste pit, prevents the entrance of insects, and separates the solid and liquid human waste.**

The total estimated material cost for this design is N\$50K per toilet. Detailed costing information can be found in Table 14.

This design addressed three issues:

#### 1. *Animal Activity*

**Problem:** The toilet facilities are open which allows animals, such as hyenas, to access the toilet facility.

**Solution:** The enclosed design blocks off hyenas from stealing the toilet seat and prevents other animals from entering the toilet facility.

#### 2. *Odor in toilet facility*

**Problem:** The wetting of solid waste creates a strong unpleasant odor.

**Solution:** The toilet bowl separates the waste prior to mixing. This separation allows the solid waste to quickly dry in the waste pit. Dried solid waste produces little odor and can be removed as fertilizer. The ventilation pipe provides additional odor relief by drawing air out of the pit and outside the toilet facility.

#### 3. *Flies inside the toilet facility*

**Problem:** The odor from wetted solid waste attracts insects into the toilet facility.

**Solution:** The insects flying around in the pit are attracted to the light at the top of the ventilation pipe and when the insects fly up the pipe, they are trapped by the insect mesh and die.

Table 14: Costing for Toilets

	USD	NAM
Vent Pipe	\$150.00	\$1,768.50

Roof	\$150.00	\$1,768.50
Facility Enclosure	\$250.00	\$2,947.50
Toilet	\$75.00	\$884.25
Door	\$30.00	\$353.70
Waste Pit	\$60.00	\$707.40
<b>Per Toilet</b>	<b>\$4,290.00</b>	<b>\$50,579.10</b>
<b>Total: 6 Toilets</b>	<b>\$25,740.00</b>	<b>\$303,474.60</b>

As shown in Figure 70, the toilet facility is a closed area.

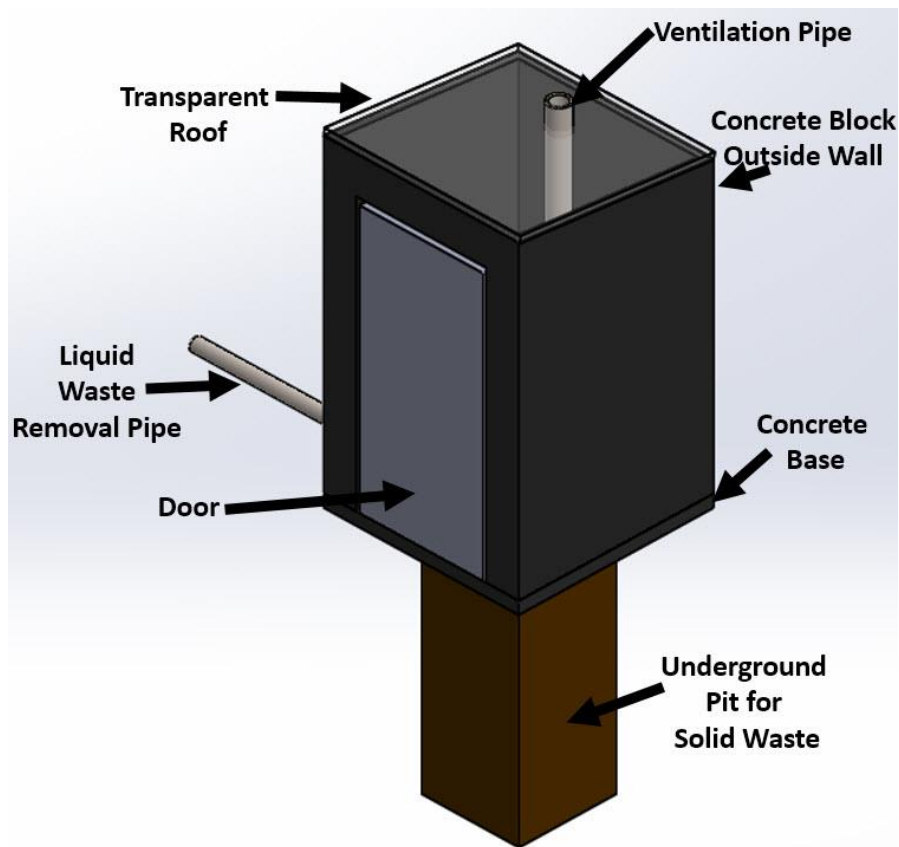

Figure 70: View of Closed in Area Toilet Facility

This closed in design prevents animal activity, including hyenas stealing the toilet seats. There is an opaque top to allow natural light into the area. The door faces the prevailing wind direction to allow for proper air circulation. When the door faces this direction, air pressure builds up in the shelter and forces air down into the pit. In the pit, there is a ventilation pipe. Once the air is pushed into the pit, it goes up the ventilation pipe and out into the outside air, reducing the odor.

The ventilation pipe leads from the dark inside of the pit straight up and to the light of the outside (Figure 71).

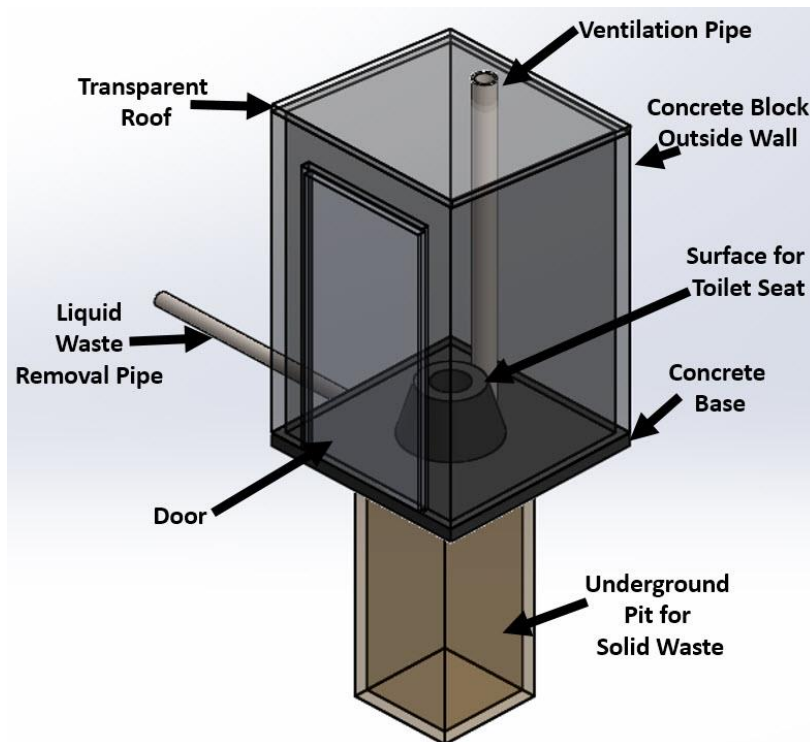

Figure 71: View of Vertical Ventilation Pipe from the Pit into the Outside Air

The top of the pipe is fit with an insect mesh (Figure 72).

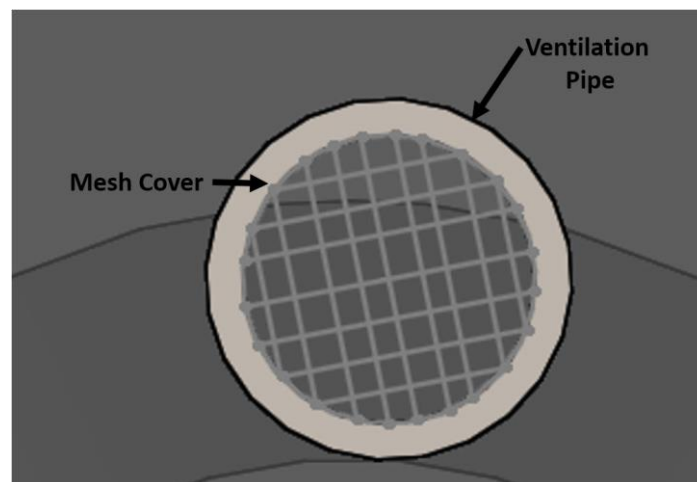

Figure 72: Insect Mesh at the Top of the Ventilation Pipe

Therefore, when the insects fly up from the dark pit toward the light, the mesh traps them. This, along with the reduced odor due to the ventilation pipe, helps to reduce the number of insects inside the toilet facility. The toilet separates solid and liquid waste. The toilet bowl is specially

designed to separate the liquid waste before it goes into the pit. This liquid waste then filters through a pipe and out to absorb into the ground (Figure 73).

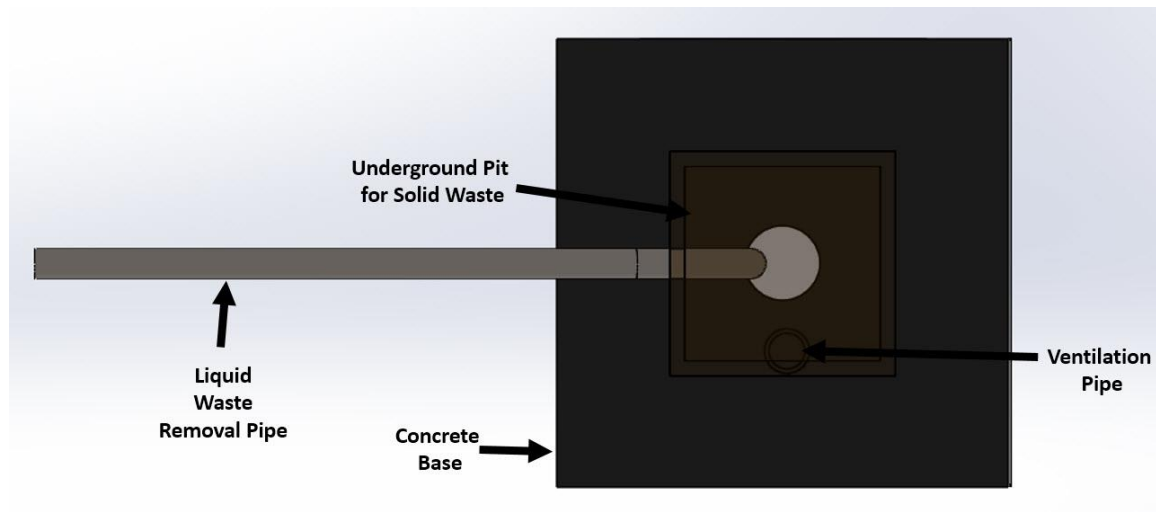

Figure 73: View of Liquid Waste Drainage Pipe

This pipe is located at the base of the toilet, before the waste enters the pit (Figure 74). The solid waste then passes through the toilet and into the pit. Once at the base of the pit, the solid waste dries out. It can then, after 6 months, be removed and used as fertilizer. The pit is deeper than the standard 1.5 meters to allow for enough room for the waste.

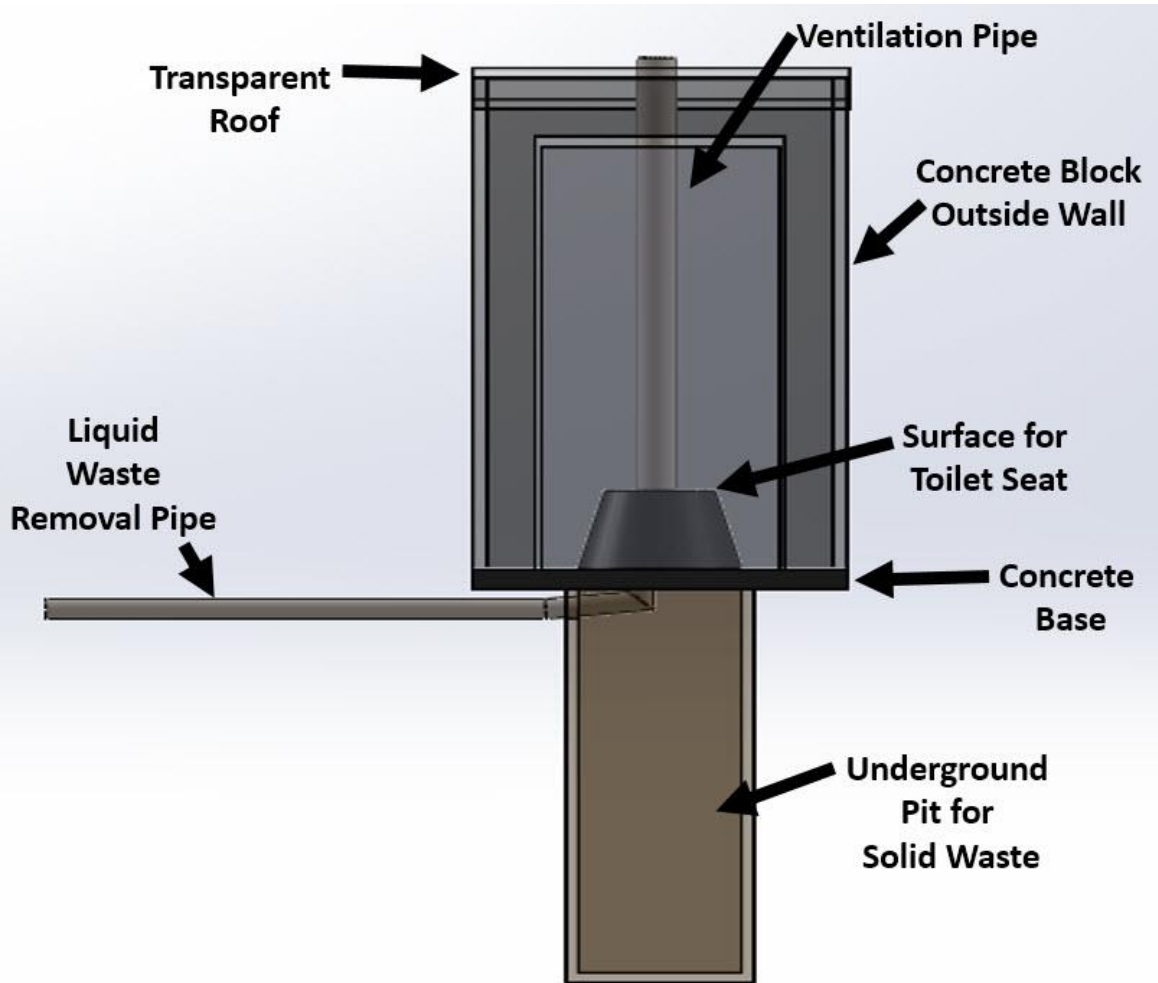

Figure 74: View of Liquid Drain Pipe Removing Waste Prior to the Pit

## Leveling

### Add sand with a retaining wall to flatten campsites.

The total estimated material cost for this design is N\$ \$1,800 per site. Detailed costing information can be found in Table 15.

This design addresses two issues:

#### 1. Area to place tents

**Problem:** The natural slope of Campsite 5 limited the potential flat areas to place a tent.

**Solution:** Flattened campsites give visitors more area to place their tents and adds the option for larger tents.

#### 2. Visitor comfort

**Problem:** The recommended incline for a tent area is 1-2°, but Campsite 5 has an incline greater than 5° which it is uncomfortable for visitors.

**Solution:** Using sand with a retaining wall flattens the campsites and softens the ground, improving the visitor's sleeping conditions.

Table 15: Costing for Flattening Campsites

	USD	NAM
River Bed Sand	\$0	\$0
Retaining Wall	\$150.00	\$1,768.50
<b>Total: 1</b>	<b>\$150.00</b>	<b>\$1,768.50</b>

The design utilizes added sand to flatten the campsites (Figure 75). The retaining wall around the outside prevents the sand from eroding away from the campsites.





Figure 75: Design for Flattening Campsites, Including a Retaining Wall

### Layout

#### Change amenity layout to improve comfort and safety for visitors.

This update has no material costs. The new layout design addresses three issues:

##### 1. Visitor comfort

**Problem:** The braai pit locations limit the number of visitors that can sit around the fire.

**Solution:** Moving the braai pits into central locations allow room for visitors to sit around the perimeter of each braai pit.

##### 2. Visitor safety

**Problem:** On two campsites, the braai pits were located on the edge of a steep drop off.

**Solution:** The braai pit locations eliminate the dangers associated with the previous locations.

##### 3. Visitor convenience

**Problems:** At two sites, the braai pits are closer than 3 meters from the tables. However, at three sites, the braai pits are further than 6 meters from the tables. At three sites, the trashcans are further than 15 meters from the table. At two sites, there are no toilets within 90 meters.

**Solutions:** Locating braai pits between 3-6 meters from the table, and ensuring there is a toilet within 90 meters from each site increases convenience for visitors. Placing trashcans between

8-15 meters from the table also increases convenience for visitors while encouraging them to use the trashcans rather than leaving their trash at the table.

Detailed amenity layouts can be seen in Figures 76-89.

### Campsite 1 Layout

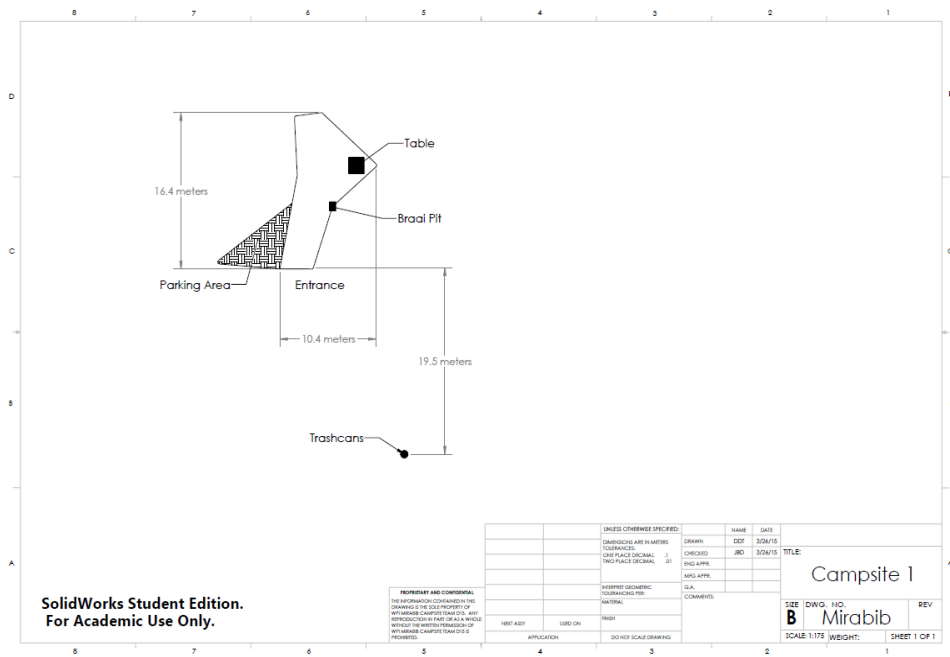

Figure 76: Existing Layout of Campsite 1

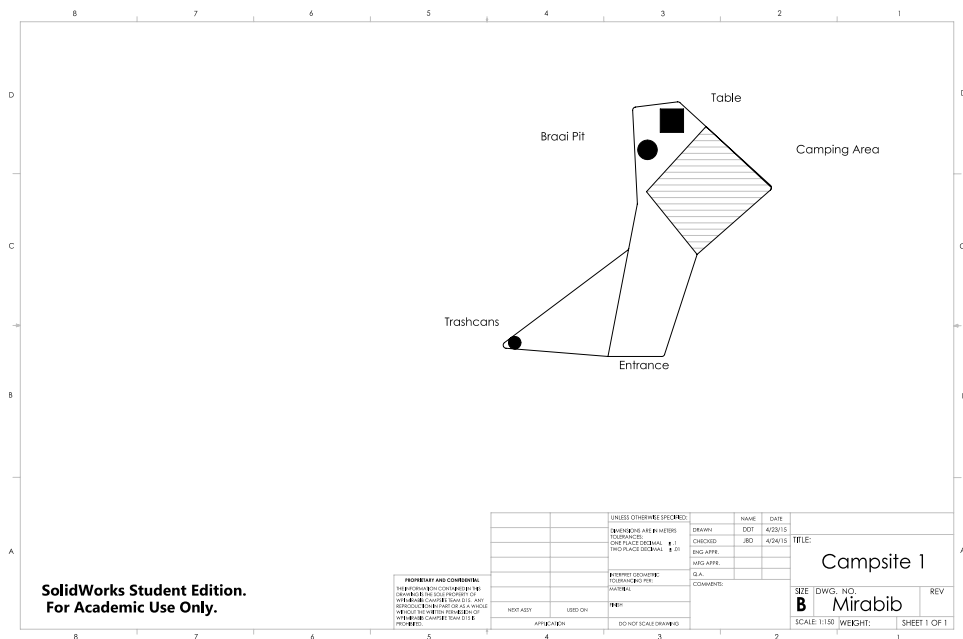

Figure 77: Proposed Layout of Campsite 1

- Occupancy Recommendation: 1-2 Campers
- Table Recommendation: 2 chair table

In order to maximize the flat area to place a tent, we moved the table and braai pit. The braai pit was also located right at the edge of a drop off, so its new location makes it safer for visitors to cook over the fire. We moved the trashcan to a closer location to make it more convenient for the visitor. The new location for the trashcan is also out of site when sitting at the table.

## Campsite 2 Layout

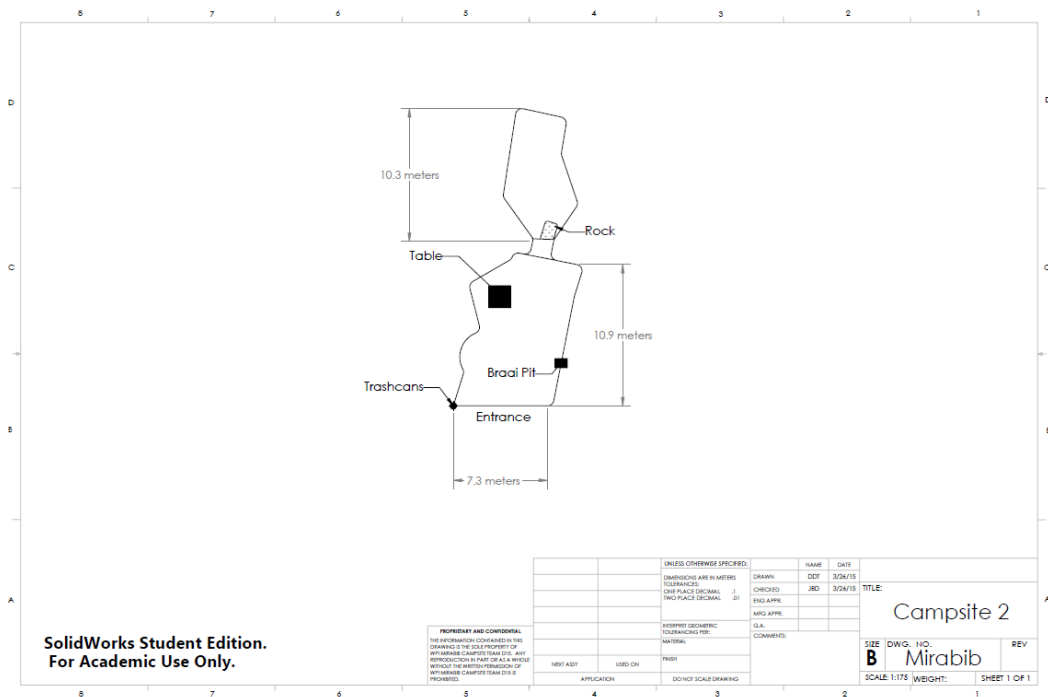

Figure 78: Existing Layout of Campsite 2

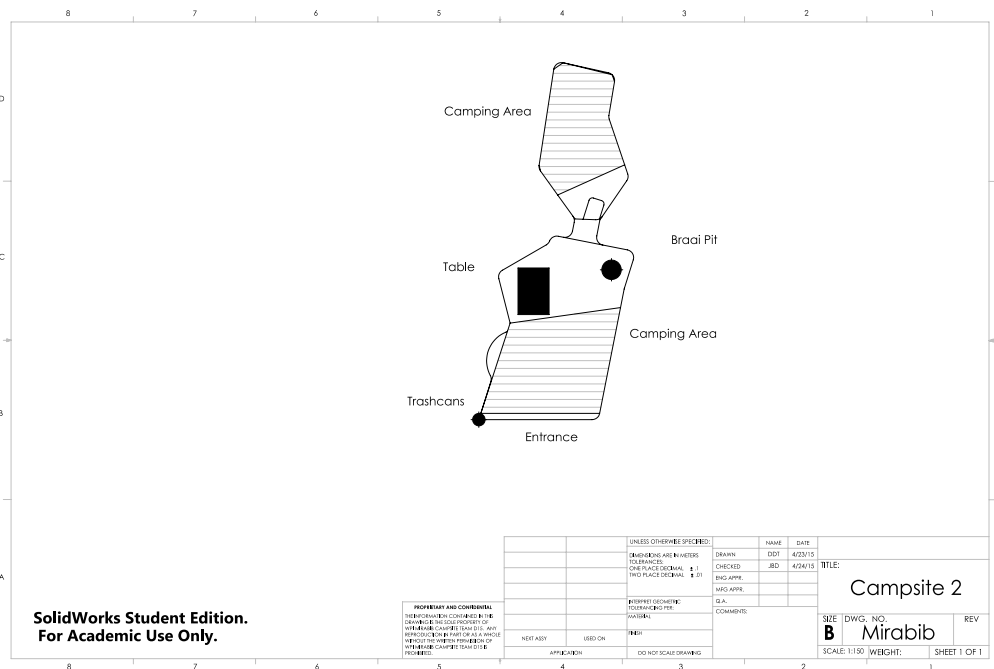

Figure 79: Proposed Layout of Campsite 2

- Occupancy Recommendation: 3-4 campers on main site, 2 campers in extra back area
- Table Recommendation: 6 chair table

On campsite 2, we moved the braai pit away from the edge of a drop off. This makes it safer for visitors to cook. The rest of the amenities remained in the same location.

### Campsite 3 Layout

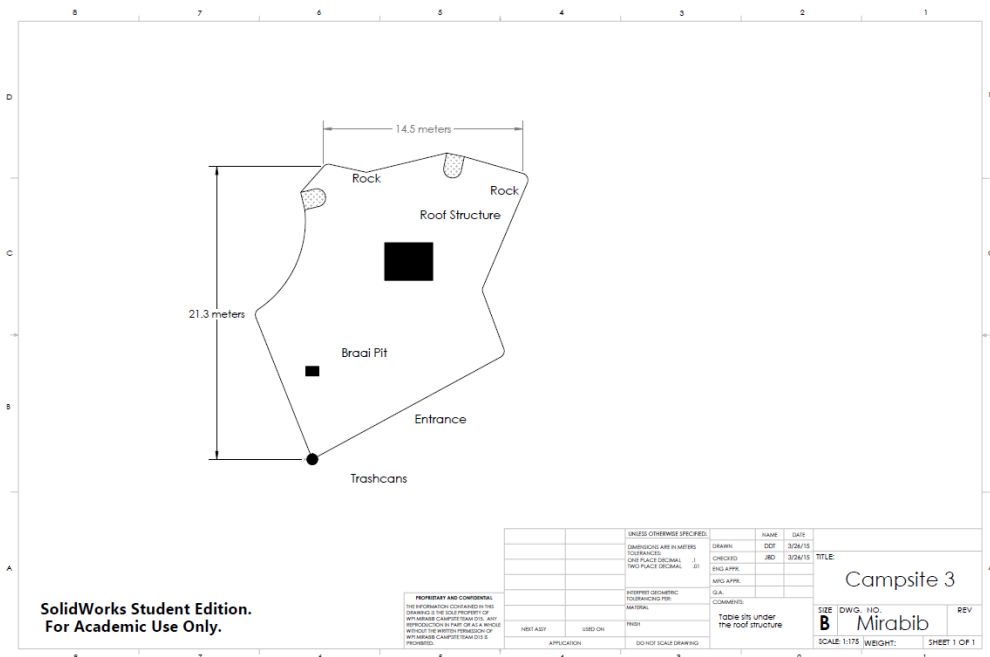

Figure 80: Existing Layout for Campsite 3

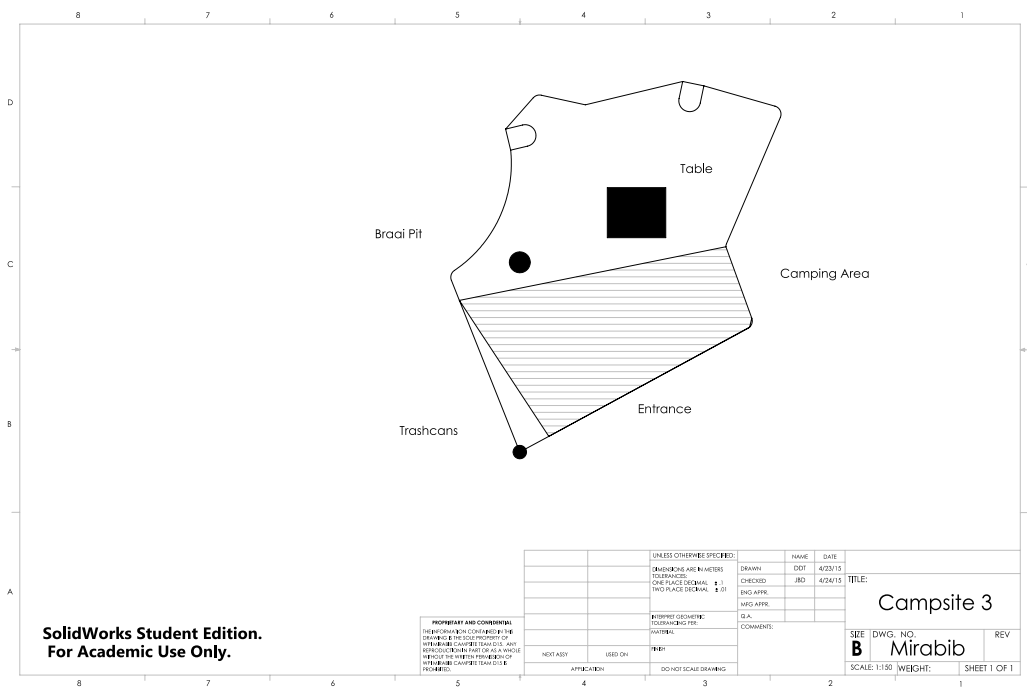

Figure 81: Proposed Layout for Campsite 3

- Occupancy Recommendation: >10 campers
- Table Recommendation: 10 chair table

The only recommended update for campsite 3 is two trashcans rather than the existing one. This is a very large site and can accommodate many visitors. The single trashcan was full, so the addition of another trashcan should help to combat this problem.



## Campsite 5 Layout

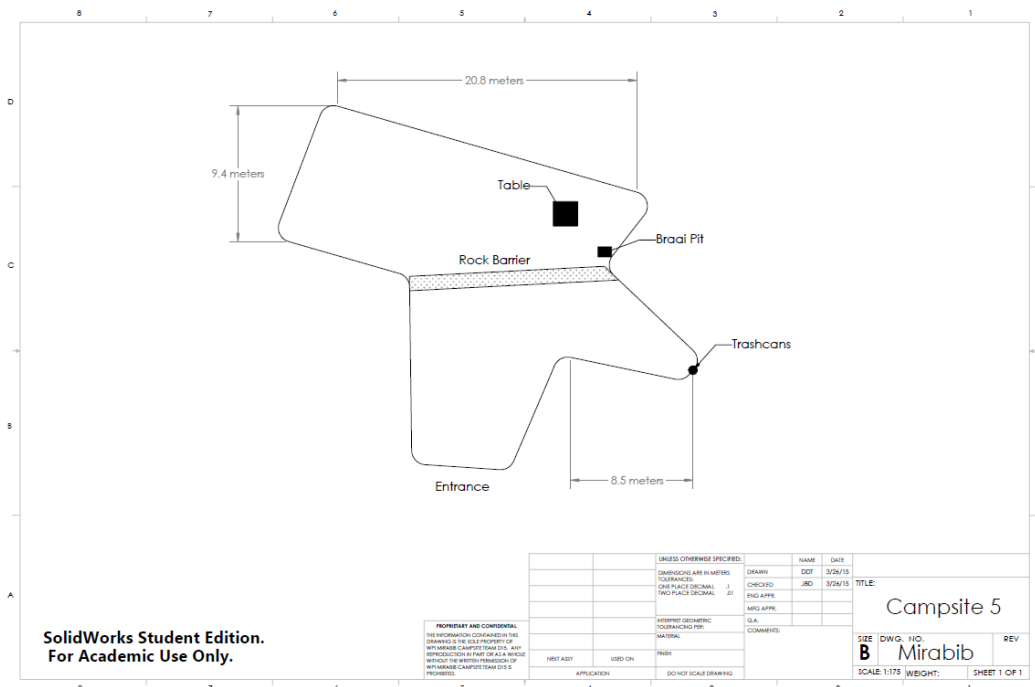

Figure 84: Existing Layout for Campsite 5

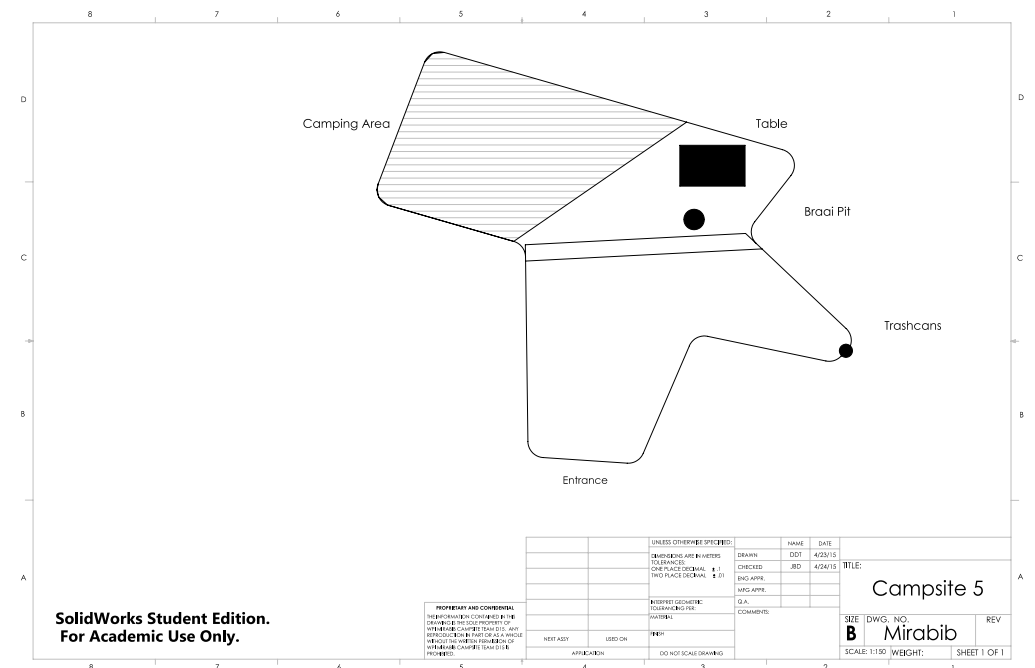

Figure 85: Proposed Layout for Campsite 5

- Occupancy Recommendation: 4-6 campers
- Table Recommendation: 6 chair table

The only recommendation for this campsite is flattening of the tent area. The inclines reached 8°, significantly higher than the standard we set for flat areas. The site has two trashcans, but since it is a larger capacity site, we recommend that both trashcans remain.

### Campsite 6 Layout

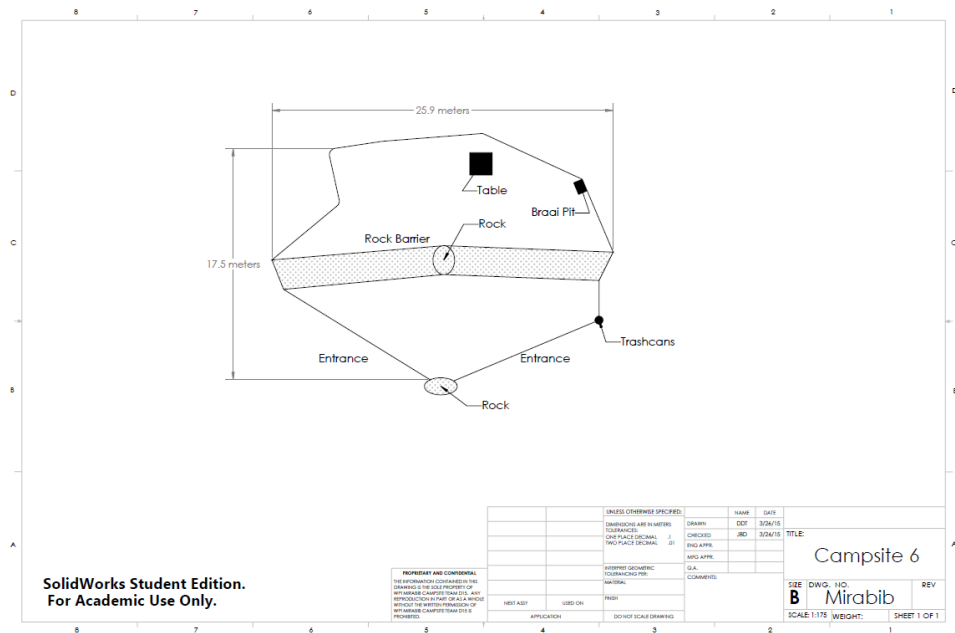

Figure 86: Existing Layout for Campsite 6

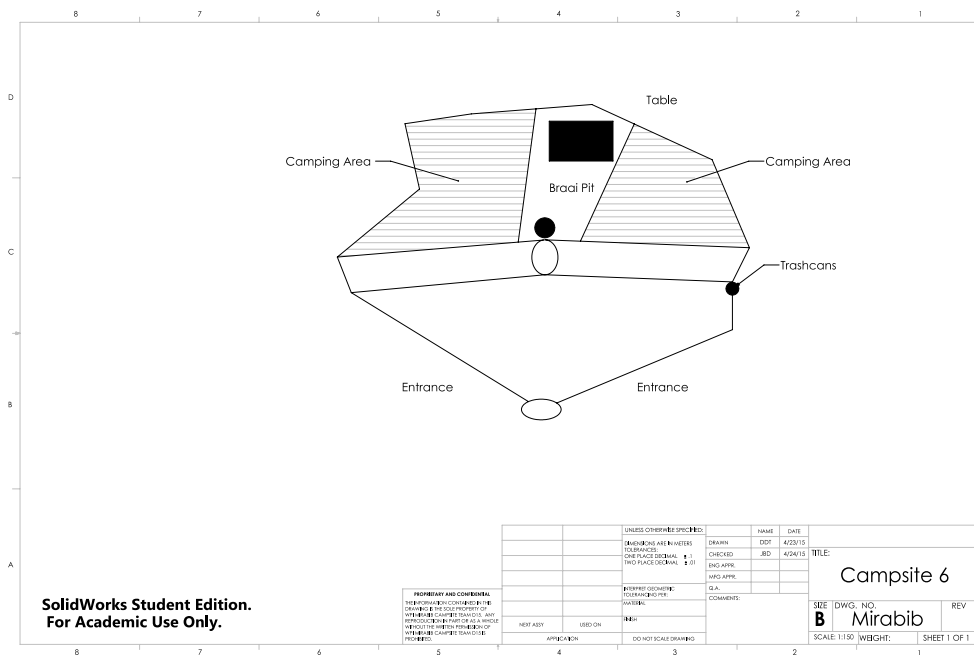

Figure 87: Proposed Layout for Campsite 6

- Occupancy Recommendation: 4-6 campers
- Table Recommendation: 6 chair table

For campsite 6 we recommend relocation of the braai pit. In its new location, there is more space to place tents. The new location also uses rocks to shelter the braai pit from the wind. We also recommend the trashcan be relocated to a new location. In the new location, the camper does not have to hike down a hill to get to the trashcan, and it is still out of sight.



### Campsite 7 Layout

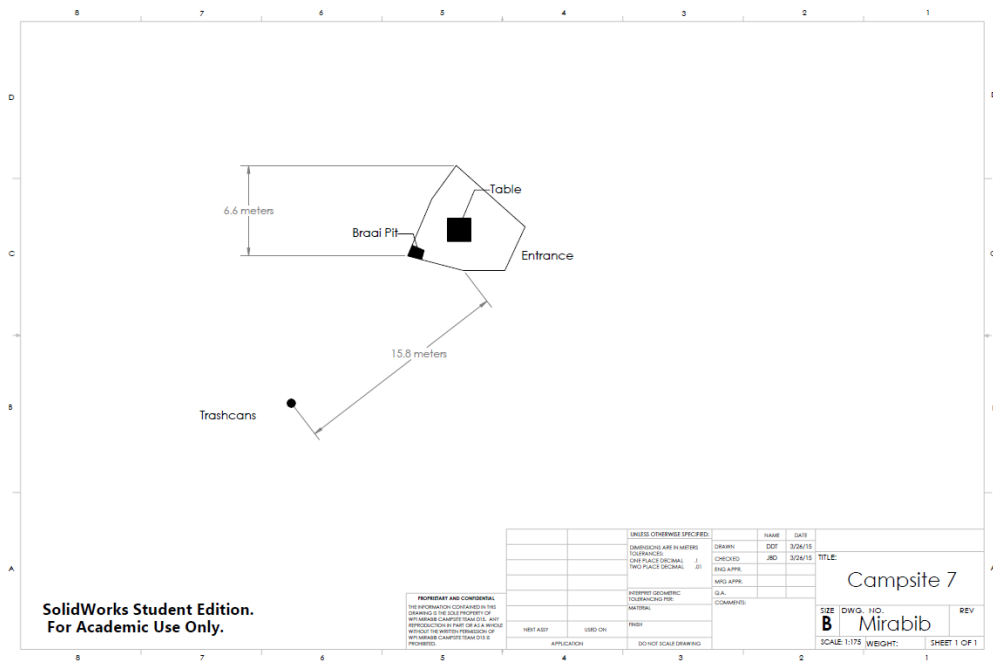

Figure 88: Existing Layout for Campsite 7

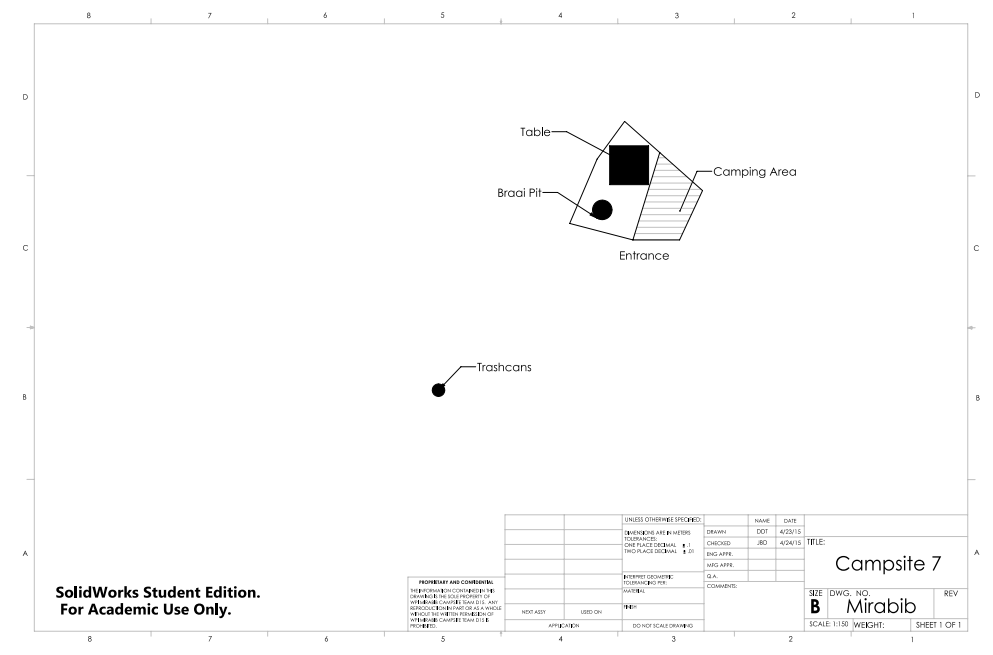

Figure 89: Proposed Layout for Campsite 7

- Occupancy Recommendation: 2-3 campers
- Table Recommendation: 4 chair table

For campsite 7, we recommend that the braai pit be moved further away from the edge.

This change makes it more comfortable for visitors to cook over the fire, while allowing more visitors to comfortably sit around the braai pit. We also recommend that the table be moved back more into the corner of the campsite to expand the flat area to place a tent.

Additionally, we recommend changes to the locations of the toilets. We recommend the removal of one toilet because it is in an unsightly location that distracts from the beautiful scenery. We recommend the addition of two toilets so that each site has a nearby toilet. Figure 90 outlines the location of all toilets.



Figure 90: Map of Location of Toilets

### Braai Pit

**Install a taller braai pit with fixed grates that limit the maximum fire size.**

The total estimated material cost for this design is N\$ \$2,400 per braai pit. Detailed costing information can be found in Table 16.

This design addresses three issues:

#### 1. Grates

**Problem:** At two campsites, braai pits are unusable because of missing grates.

**Solution:** A built-in grate design discourages visitors from removing and stealing the grates.

#### 2. Fire size

**Problem:** The open slab design does not limit the amount of wood visitors can use inside the braai pit. A large amount of wood produces large fires and excessive heat, which cracks the braai pit's concrete.

**Solution:** The braai pit design limits the amount of wood and coals that can fit inside the braai pit, reducing the size of fires. Smaller fires create less heat, preserving the concrete.

### 3. Height

**Problem:** While cooking, the visitors are required to uncomfortably squat because the braai pits are only 10cm tall.

**Solution:** The braai pit design is 40cm tall, allowing the visitor to comfortably cook while either in a standing or seated position. While in a seated position, the fire base is at a standard chair seat height.

Table 16: Costing for Braai Pits

	USD	NAM
Grate	\$30.00	\$353.70
Concrete	\$130.00	\$1,532.70
Steel Height Adjuster	\$40.00	\$471.60
<b>Per Braai Pit</b>	<b>\$200.00</b>	<b>\$2,358.00</b>
<b>Total: 7 Braai Pits</b>	<b>\$1,400.00</b>	<b>\$16,506.00</b>

Figure 91 shows the braai pit with attached grate.

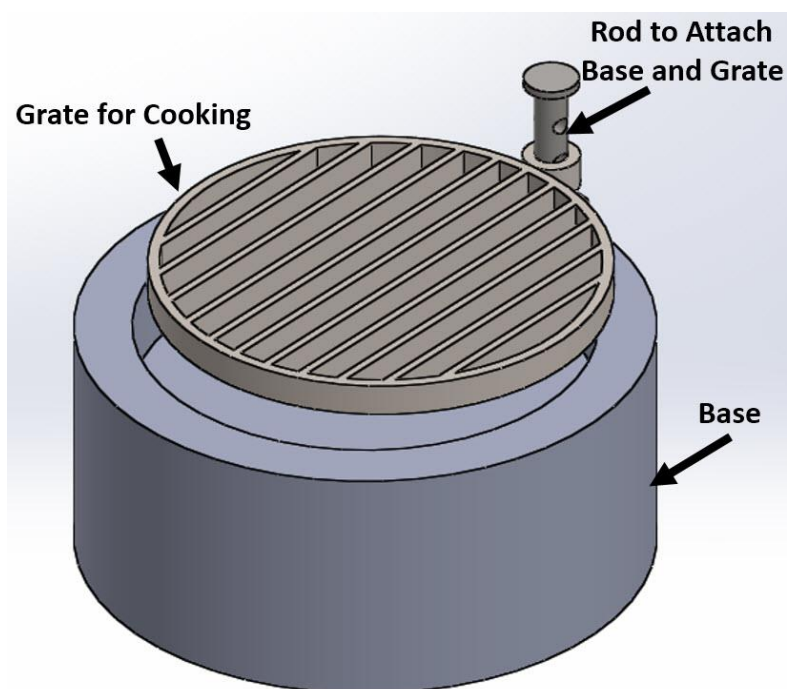
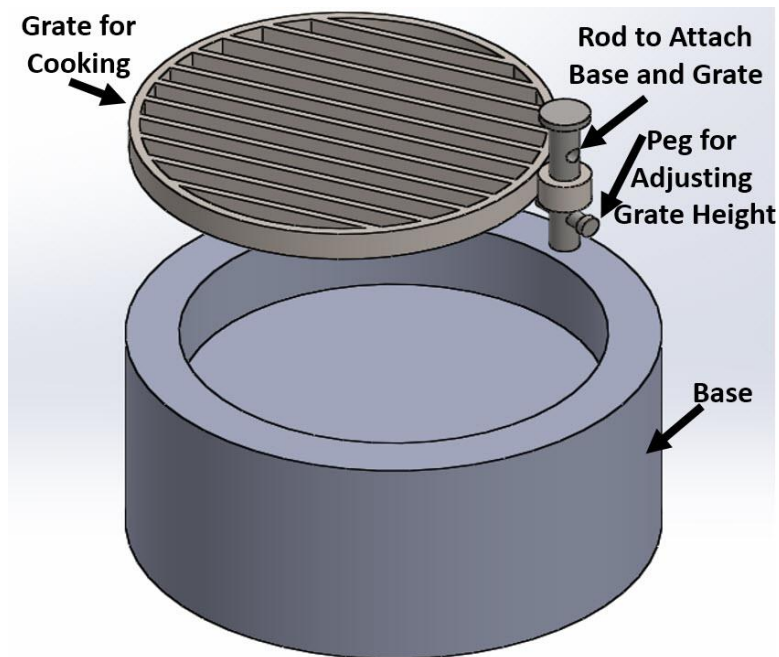

Figure 91: Braai Pit with Attached Grate

This irremovable grate helps to guard against visitors stealing and breaking the braai pit. The grate can be rotated around to allow the visitor to fill the pit with wood (Figure 92).



*Figure 92: Rotating Grate to Allow Wood to be Placed Inside Braai Pit*

The height of the braai pit is comfortable for the visitor to use in both a sitting and standing position. The depth of the area for putting wood (Figure 93) limits the amount of wood that can be used to fuel to fire. By limiting the size of this area, the fires will produce less heat and prevent cracks from forming in the concrete.

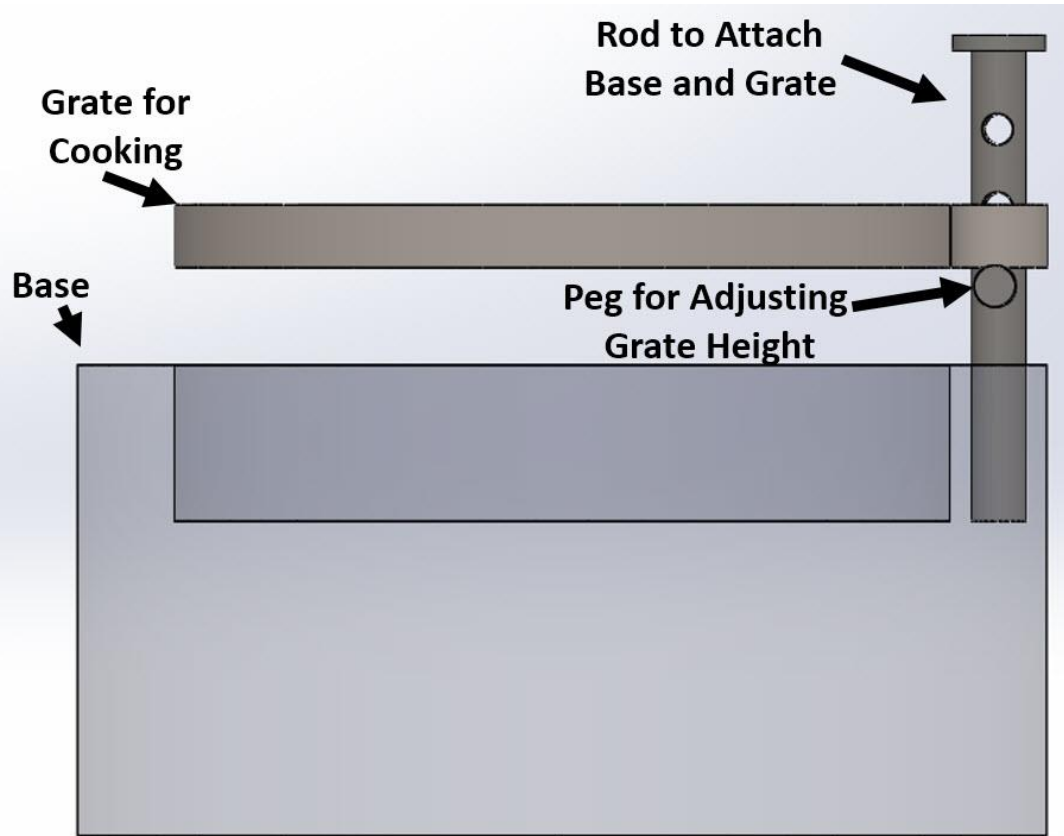

Figure 93: View of Small Area to Place Wood to Limit Fire Size

*Table***Install a steel framed concrete table with replaceable concrete chairs to reduce maintenance requirements.**

The total estimated material cost for a six chair table design is N\$ \$4,400 per table for a design. Detailed costing information can be found in Table 17.

This design addresses three issues:

1. *Durability*

**Problem:** In the multi-piece design, chairs go missing and are easily broken.

**Solution:** The steel frame and one-piece design increases the durability of the table. In a dry climate, the steel frame rusts at a lower rate in a dry climate than in a wet climate.

2. *Cost of replacement components*

**Problem:** When one chair breaks in the one-piece design, the entire table and chair unit must be replaced. Therefore, damage to the table has a high replacement cost.

**Solution:** In the table design, the replacement of individual concrete chairs does not require the replacement of the entire table and chair unit. This feature reduces the overall replacement costs.

3. *Visitor Comfort*

**Problems:** The visitor's knees are bent at a sharp angle when in a seated position because the chairs are low to the ground. Chairs are positioned too close to adjacent chairs, forcing visitors to sit uncomfortably close to the adjacent visitors. Compared to the height of the chairs, the tabletop is too tall for comfortable use.

**Solutions:** The table design has standard measurements for chair height, table height, and distance between chairs at the table.

Table 17: Costing for Tables

	USD	NAM
Steel Hollow Bars	\$120.00	\$1,414.80
Cement	\$200.00	\$2,358.00
Steel Mount	\$50.00	\$589.50
<b>Per Table</b>	<b>\$370.00</b>	<b>\$4,362.30</b>
<b>Total: 7 Tables</b>	<b>\$370.00</b>	<b>\$4,362.30</b>

The full view of the table is shown in Figure 94.

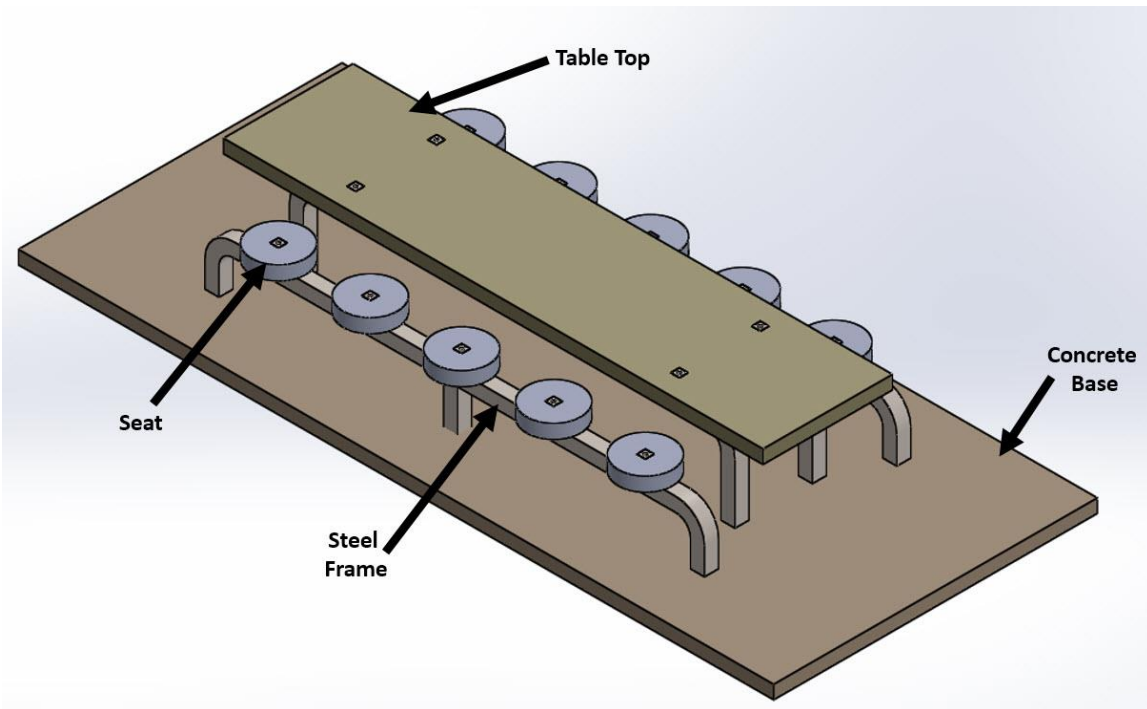

Figure 94: Full Table Design

As discussed, the table has a one-piece design. The table legs and chair legs are embedded in the cement to make it difficult to remove or break the infrastructure. The steel frame, Figure 95, is a simple, but sturdy design.

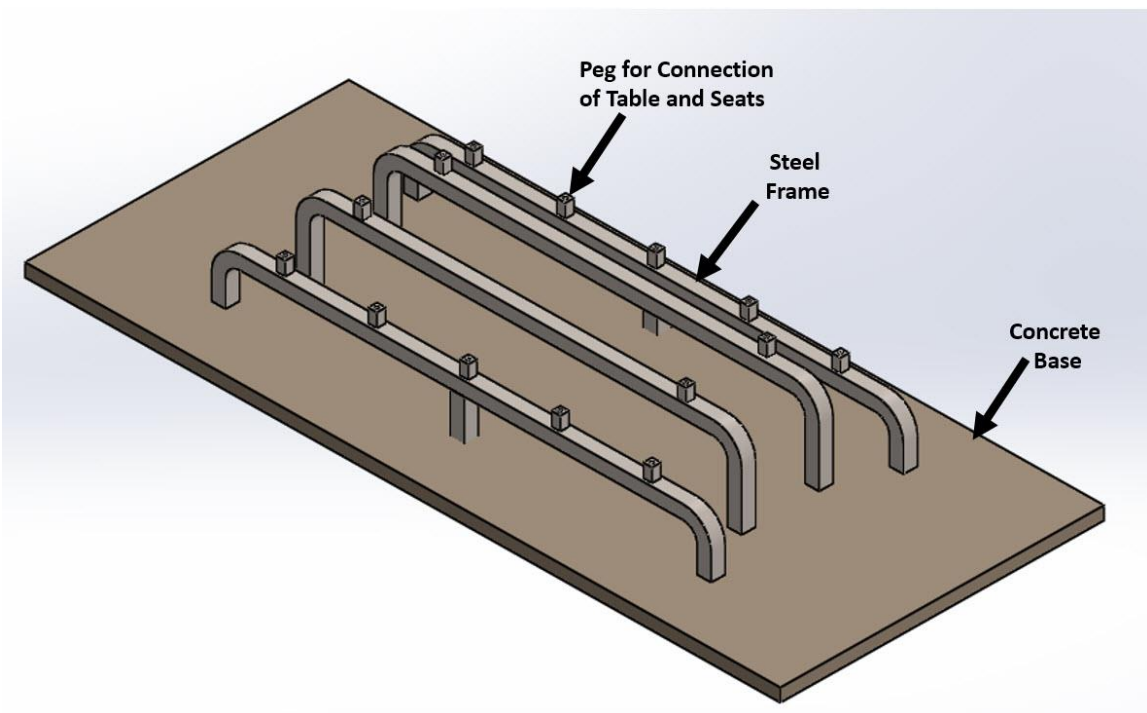
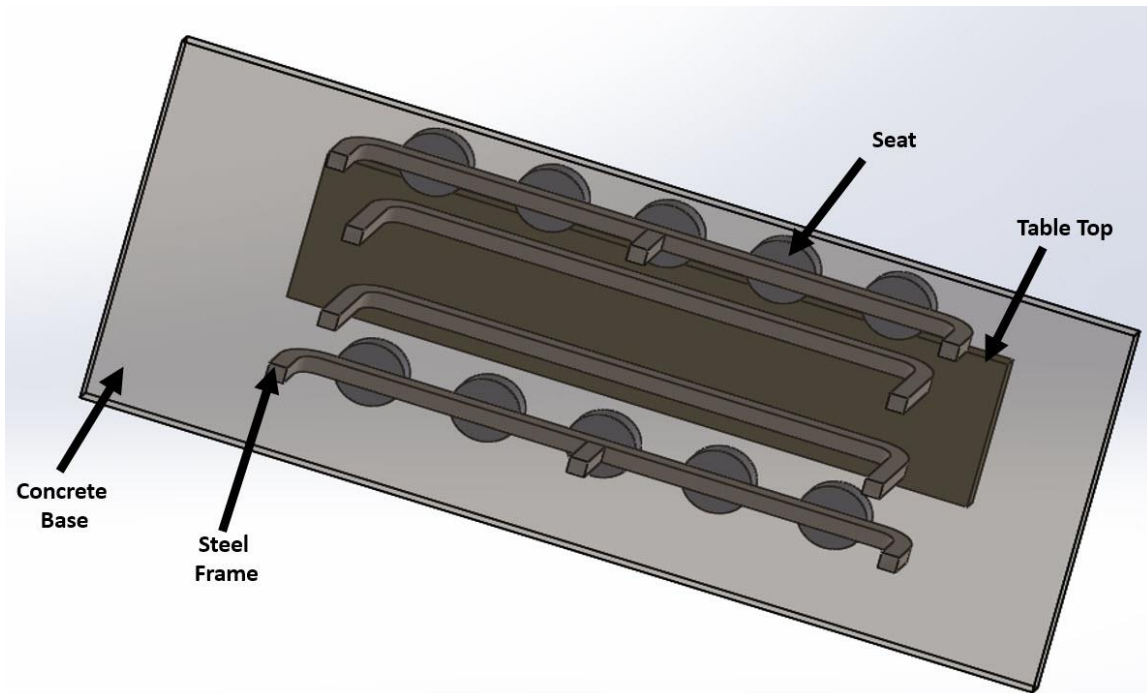

Figure 95: Steel Table Frame

As shown in Figure 96, on the underside of the table, the table contacts the steel for a maximum length.

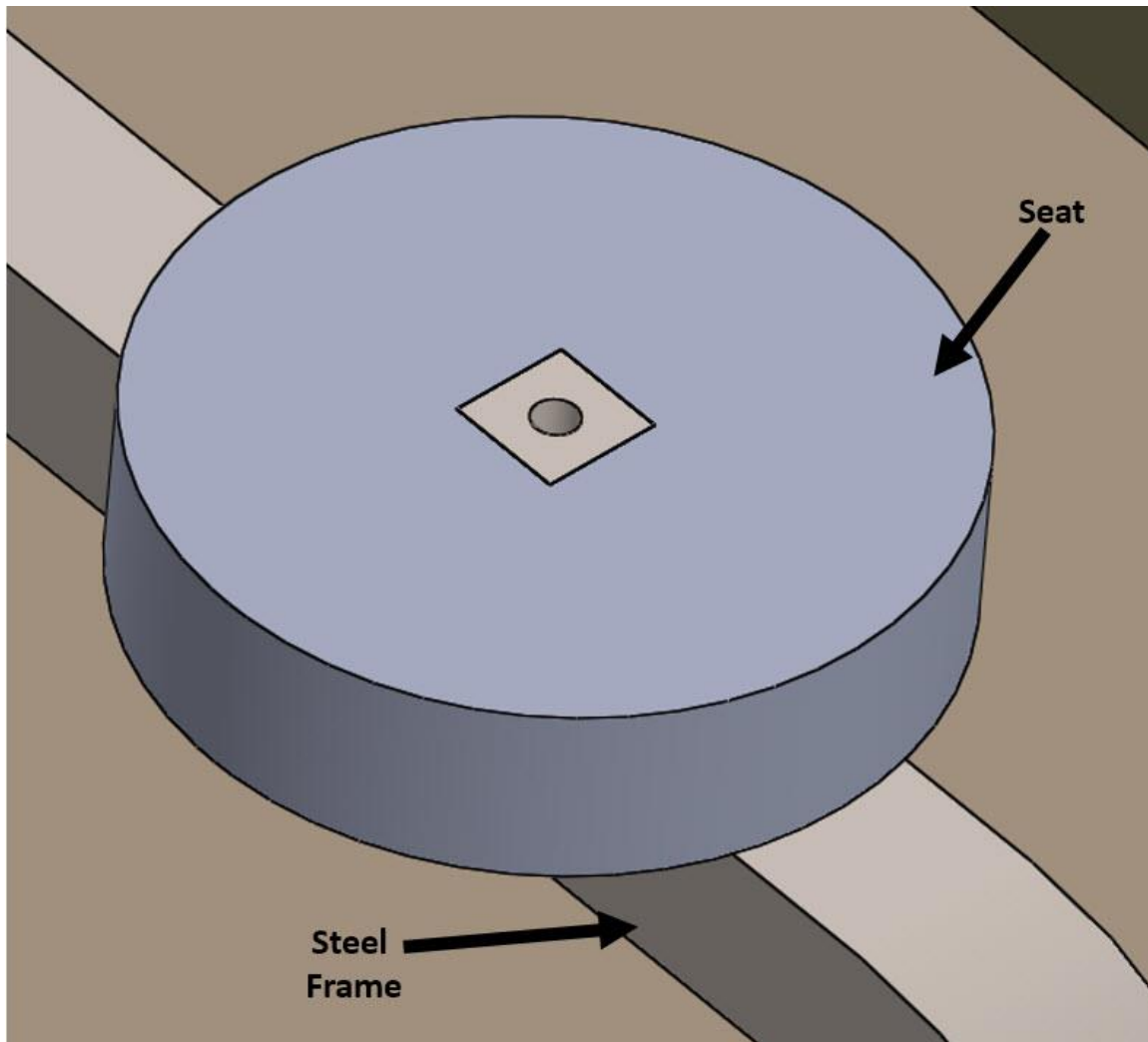

*Figure 96: View of Attachment of Steel Frame to Table and Chairs*

This increases the overall strength of the table. The table and each individual chair are bolted on to the steel frame. There is a metal encased thread cast into each cement unit. This ensures that the grip of the screw is metal-to-metal, stronger than a thread made in cement. A large screw is then placed through the top of the table or chair into the thread, and through to a thread located in the steel frame. This attaches each cement unit to the frame. Because of this design, if one chair is broken, the broken piece can be unscrewed and a new piece can be put on without



replacing the entire table. The steel casing for the thread can be seen in Figure 97.



*Figure 97: Attachment of Chair and Table to Steel Frame*

The table has standard distances of a table height of 75 cm, a chair height of 45 cm, a distance between chairs of 60cm, and a distance of 20-35 cm from table to chair. These standard distances help to ensure that the table is at a comfortable height with respect to the table, the chair is not too tall or too short to be comfortable, the chairs are adequately spaced so other that people sitting next to each other don't bump elbows, and that the table and chairs are a comfortable distance apart for eating.

## Appendix S: Community Based Campsites in Namibia

---

### *Rupara Community Camp - Wuparo Conservancy*

---

#### SANGWALI VILLAGE

**GUIDED TOURS AND VISITS TO LOCAL VILLAGES** ARE AVAILABLE UPON REQUEST FOR THOSE THAT WANT TO LEARN ABOUT THE REGION'S FLORA, FAUNA, CLIMATE, GEOLOGY, CULTURES AND HISTORY (SOME ACTIVITIES MAY BE OFFERED NEARBY) (TRACKS4AFRICA, 2015).

---

### *Boiteko Campsite - Omaheke Region*

---

#### BATSWANA PEOPLE

THE ACTIVITIES OFFERED FOR GUESTS INCLUDE **A VILLAGE WALK** TO EXPERIENCE THE EVERYDAY CONTEMPORARY LIFESTYLE OF THE BATSWANA PEOPLE, FROM THE MAKING OF FOOD IN THE THREE-LEGGED COOKING POTS TO THE COW-DUNG AND CLAY THAT IS STILL USED TO BUILD HOUSES. THE TOUR **MAY INCLUDE A VISIT TO THE PRIMARY SCHOOL AND KINDERGARTEN**, DEPENDING ON THE TIME OF DAY, THE COMMUNITY CHURCH, THE OLD CHURCH ON THE MISSION GROUNDS AND GERMAN GRAVES. IT ENDS WITH A PERFORMANCE BY EITHER AN **ADULT OR SCHOOL CULTURAL SONG-AND-DANCE GROUP** (BOITEKO CAMPING, 2015).

---

### *KAUMBANGERE CAMPSITE – OMAHEKE REGION*

---

#### OVAHERERO PEOPLE

- VISITS TO HISTORIC PLACES
- **TRADITIONAL PERFORMANCES BY THE OVAHERERO PEOPLE** E.G. HOLY FIRE, COW MILKING, ETC
- **A TOUR TO NEARBY VILLAGES** TO OBSERVE DAY TO DAY LIVES OF THE LOCAL PEOPLE
- TOURS TO WEDDING CEREMONIES AND FUNERAL WHERE APPLICABLE
- A VISIT TO SAN PEOPLE
- SERVICES OF A TRAINED GUIDE (NAMIBWEB.COM, 2015)

---

### *OMATAKO VALLEY RESTCAMP – OTJOZONDJUPA REGION*

---

#### SAN PEOPLE

WHEN STAYING AT THE OMATAKO REST CAMP YOU CAN CHOOSE TO GO ON A GUIDED VILLAGE TOUR. THIS WALK TAKES A FEW HOURS AND YOU WILL BE GUIDED THROUGHOUT YOUR VISIT TO MEMBERS OF THE COMMUNITY. GO ON A GUIDED BUSH-WALK WITH AN EXPERIENCED HUNTER, PLUS YOUR GUIDE, AND LEARN ABOUT MEDICINAL AND EDIBLE PLANTS, STORIES, TRADITIONAL HUNTING AND TRACKING PRACTICES. MEMBERS OF THE COMMUNITY WILL SHARE THEIR TRADITIONAL DANCES WITH YOU BY STARLIGHT... AS THERE DANCERS SPIN, PERHAPS INTO A TRANCE, EVERYONE WILL

SING UNTIL THE RHYTHMS LULL YOU TO YOUR OWN DREAMS.... **WAYS TO HELP INCLUDE:** PAYING CAMPING FEES, BUYING FIREWOOD FOR YOUR BRAAI, PAYING FOR A VILLAGE TOUR, PAYING GUIDES FOR A BUSH-WALK, PAYING FOR SONGS AND DANCES BY FIRELIGHT - THIS CAN BENEFIT ALMOST THE WHOLE COMMUNITY AS THE FEES ARE DIVIDED AMONGST ALL WHO TAKE PART, PURCHASING HANDMADE CRAFTS FROM OUR ON-SITE CRAFT SHOP, SUPPORTING US BY PURCHASING SUSTAINABLY PRODUCED DEVIL'S CLAW THROUGH THE CONSERVANCY PROJECT, SPREADING THE WORD ABOUT OMATAKO VALLEY REST CAMP TO OTHERS (OMATAKOVALLEY.COM, 2015).

---

### *TSINTSABIS TREESLEEPER CAMP - ETOSHA REGION*

---

80% HEI//OMN BUSHMEN (PLUS !KHUNG BUSHMEN, KAVANGO, OWAMBO AND DAMARA)

TODAY THE CAMPSITE IS 100 PER CENT COMMUNITY-OWNED AND ADMINISTERED BY THE TSINTSABIS TRUST. THE SEVEN EMPLOYEES, CRAFTERS SUPPLYING THE SMALL CRAFT SHOP, TRADITIONAL SINGERS AND THE VILLAGE FAMILIES THAT ARE VISITED, ALL BENEFIT FROM THE MONEY GENERATED FROM THE CAMPSITE, EACH PERSON SOMETIMES SUPPORTING UP TO SIX PEOPLE. WHEN YOU VISIT TREESLEEPER CAMP WE CAN OFFER YOU **THREE ACTIVITIES:** A BUSHWALK, A VILLAGE TOUR AND A TRADITIONAL PERFORMANCE.

IF YOU DO THE BUSHWALK YOU WILL GET A DEEPER UNDERSTANDING OF THE RELATIONSHIP THAT THE BUSHMEN PEOPLE USED TO HAVE (AND STILL HAVE SOMETIMES) WITH NATURE. YOU WILL LEARN ABOUT EDIBLE, POISONOUS AND MEDICINAL PLANTS, SEE HOW THEY USED TO HUNT ANIMALS, SET UP TRAPS AND MADE FIRE. THE BUSHWALK IS IDEAL FOR LEARNING ABOUT THE TRADITIONAL WAY OF LIFE OF THE BUSHMEN. ONE GUIDE TAKES YOU INTO THE BUSH AND EXPLAINS ABOUT ALL THESE TRADITIONS.

IF YOU DO OUR VILLAGE TOUR YOU WILL GET A BETTER UNDERSTANDING OF A CULTURE IN WHICH TRADITIONS HAVE NOW MET THE 'MODERN WORLD'. YOU WILL VISIT TWO VERY DIFFERENT CURRENT BUSHMEN VILLAGES AND TWO FAMILIES. HERE YOU WILL SEE HOW THEY LIVE NOWADAYS AND LEARN MORE ABOUT THE CONTEMPORARY SITUATION. ONE GUIDE WILL INTRODUCE YOU TO FAMILIES WHERE YOU CAN ASK QUESTIONS AND TAKE PHOTOGRAPHS. THIS TOUR IS ABOUT TODAY'S '**REAL LIFE SITUATION**' AND DOES NOT EXHIBIT BUSHMEN PEOPLE IN TRADITIONAL CLOTHES. APART FROM THE FEE FOR THE VILLAGE TOUR, **YOU WILL ALSO BE ASKED KINDLY TO BRING A SMALL APPRECIATION** FOR THE FAMILIES YOU WILL VISIT (THIS CAN BE ANYTHING THAT YOU WANT TO GIVE, A T-SHIRT, A BAG OF SUGAR, SOME TEA). WE DO THIS FOR ENTERING THEIR HOUSES AND GARDENS AND FOR TAKING PICTURES. AND THIS WAY THESE PEOPLE GET SOME EXTRA SUPPORT.

A TRADITIONAL PERFORMANCE BY BUSHMEN IS SOMETHING MAGIC. YOU CAN SEE TRADITIONAL SINGING, DANCING, HEALING AND OTHER CEREMONIES OF THE BUSHMEN, PERFORMED BY CHILDREN OF THE TSINTSABIS JUNIOR SECONDARY SCHOOL OR BY AN ELDERLY TRADITIONAL HEALING GROUP. **IN CASE OF THE CHILDREN YOU SUPPORT THE CULTURAL ACTIVITIES OF THE SCHOOL.** THE SCHOOL HAS A FUND FOR CULTURAL ACTIVITIES AND TREESLEEPER CAMP SUPPORTS THAT FUND. YOU WILL GET EXPLANATIONS AND LEARN ABOUT THE RITUAL DANCES AND CEREMONIES AND ITS' MEANINGS THAT ARE TAKING PLACE AROUND A CAMP FIRE (TREESLEEPER.ORG, 2013).

### *TOPNAAR COMMUNITIES TOURS*

---

*PHOTO VENTURES NAMIBIA – WALVIS BAY*

---

**TOPNAAR 4x4 TOUR:** THE TOPNAAR DRIVE IS A 2-3 HOUR SCENIC AND EDUCATIONAL DRIVE.

**TOPNAAR QUAD BIKE TOUR:** THE TOPNAAR ROUTE IS A 2 HOUR SCENIC AND EDUCATIONAL DRIVE (PHOTOVENTURES NAMIBIA, 2013).

---

*SPRINGBOK ATLAS TOURS AND SAFARI – WALVIS BAY*

---

QUAD BIKE ADVENTURE: **A SCENIC DRIVE** THAT COMBINES BEAUTIFUL LANDSCAPES, MAGICAL COLOURS AND THE UNBELIEVABLE LIFE OF ANIMALS AND THE **TOPNAAR PEOPLE AND THEIR SURVIVAL IN THE DESERT**. AN UNFORGETTABLE EXPERIENCE WITH COUNTLESS PHOTO OPPORTUNITIES OF ENCHANTING ANIMAL FOOTPRINTS (FROM THE TIME WHEN THE KUISEB DELTA HAD A LOT MORE WATER), DESERT VEGETATION (PLANTS THAT HAVE ADAPTED TO SURVIVE EXTREME CONDITIONS), WILDLIFE (SUCH AS THE SMALL FIVE: LIZARD, GECKOS, SCORPIONS AND SNAKES) AND THE TOPNAAR TRIBE. THE TOPNAARS ARE A SEMI NOMADIC TRIBE DIVIDED INTO TWO GROUPS; THE SOUTHERN AONIN GROUP AND THE NORTHERN GOMEN GROUP. THE GOMEN TOPNAARS SETTLED CLOSE TO SESFONTEIN WHILE THE AONIN TOPNAARS SETTLED AT THE MOUTH OF THE KUISEB RIVER VALLEY, WHICH PROVIDED THEM WITH ADDITIONAL SOURCES OF FOOD, PARTICULARLY THE WELL-KNOWN NARA PLANT (SPRINGBOKATLAS.COM, 2015).

---

*LEVO TOURS – WALVIS BAY*

---

**TOPNAAR COMBO:** THE TOPNAAR COMBO TOUR BEGINS WITH THE MORNING DOLPHIN & SEAL TOUR, AFTER WHICH CLIENTS RETURN TO THE WALVIS BAY TANKER JETTY, BEFORE HEADING OUT ON A **4x4 OR QUAD BIKE EXCURSION TO A TOPNAAR COMMUNITY**. DURING YOUR VISIT TO THE COMMUNITY, YOU WILL LEARN ABOUT THE IMPORTANCE OF THE !NARA PLANT AND HOW IT IS HARVESTED. YOU WILL ALSO HAVE THE OPPORTUNITY TO MEET ONE OR TWO LOCAL TOPNAAR DUNE ARTISTS (LEVO TOURS, 2015)

[Return to Top](#)

## Appendix T: Detailed Management Plan

### Phase 1: Weekly Monitoring Honor System

Since the daily average number of visitors to the campsites is unknown, we recommend experimenting with a payment honor system.

#### **Process:**

Visitors pay a visitors fee at the Mirabib Campsites into a secured payment box, located at the entrance of the campsites. Once per week, the maintenance staff visits the Mirabib Campsites, withdraws the money from the payment box, and cleans the campsite. This money is used to clean the campsites once per week and improve the infrastructure to enhance the visitor experience.

#### **Secured Payment Box:**

This box must be located at the entrance of the campsites, securely fastened to the recommended informational board. This box must have a small opening on the top, large enough to insert notes and coins, but small enough to prevent visitors from reaching inside the box. The box must have key access so that maintenance staff can empty the contents when required.

#### **Payment Notice Sign:**

To catch the eye of visitors on the road, a sign that states “Pay Here” must be attached to the secured payment box. This sign must also include the visitor fee and a brief description of what the collected visitor fees are used for. This brief description states that the visitor fees received are put towards the maintenance of the campsites, and current maintenance is performed once per week due to the large size of the park. Since the Mirabib Campsites attract respectful eco-tourists, this brief description encourages the visitor to pay the visitor fee, and contribute to the upkeep of the campsites.

#### **Visitor Fees Collected:**

The visitor fees collected must be put towards the upkeep and development of the Mirabib Campsites. Upkeep includes the cost of petrol, salary, and maintenance supplies required. The development includes updates to the campsite infrastructure that enhance the visitor experience while preserving the campsite’s sense of natural solitude and remoteness.

#### **Travel Costs:**

Due to the large size of the national park, daily visits to the campsites take a high toll on petrol expenses. An accurate number of visitors is needed to determine if projected revenue will

offset the travel costs. However, since there are no visitor statistics for the Mirabib Campsites, the average number of visitors is unknown. After discussion with park maintenance staff, we determined that a weekly monitoring level is an appropriate starting place.

#### **Future Research:**

Phase 1, the weekly monitoring system, is a low cost method with low enforcement of visitor fee payments. To implement phase 2, we recommend the following issues be addressed:

#### **Visitor Statistics:**

An accurate number of visitors is needed to determine if projected revenue will offset the travel costs. However, since there are no visitor statistics for the Mirabib Campsites, the average number of visitors is unknown. We recommend that the MET permit office record the specific campsites (e.g Mirabib Campsites) that the tourists intend to visit. Although the tourist's plans can change once in the park, which reduces the statistics accuracy, this method provides more accurate information about the number and frequency of visitors at the Mirabib Campsites. This information is used to project estimated revenue for the phase 1 operations.

#### **Visitor Feedback:**

In the findings section, we developed a persona for a Mirabib Campsites visitor that has three traits: passion about the outdoors and respect the camping environment, appreciation for solitude, and an eco-friendly mindset. However, because it was low tourist season, we were limited by the number of visitors we could interview. Therefore, we recommend that avenues for visitors to leave feedback must be established. Continuous feedback from visitors informs maintenance staff about campsite concerns and identifies improvement opportunities to enhance visitor experience.

#### **Sample Data used for Reasoning:**

The following data represents a sample picture of the Expense vs. Revenue based on the average number of visitors at the Mirabib Campsites.

*\*Note that these are only estimates based on many assumptions, and may change depending on varying conditions.*

<b>Expenses</b>		
<b>Petrol</b>	Distance (km)	114
	Car Efficiency (l/100km)	20
	Price per Liter (petrol)	\$ 10.00
	Trips per Week	1
<b>Upkeep</b>	Cost per Visitor	\$ 2.00
<b>Salary</b>	Number of Employees	2
	Hours per Employee per trip	3
<b>Marketing</b>	Avg salary per hour	\$ 200.00
	Marketing Budget	\$ 1,000.00

Figure 98: Expense Assumptions for Managing the Mirabib Campsites

#### Expense Assumptions:

1. Distance (km): roundtrip distance from Ganab station to the Mirabib Campsites is 120 km
2. Car Efficiency (l/100km): Average efficiency for trucks
3. Price per Liter (petrol): approximate price per petrol on 24 April, 2015
4. Trips per Week: weekly monitoring system
5. Cost per Visitor: upkeep cost per visitor
6. Number of Employees: employees required to clean and maintain the campsites
7. Hours per Employee per Trip: Two hours roundtrip from campsites to Ganab station. One hour for campsite maintenance
8. Average Salary per Hour: varies on position
9. Marketing Budget: estimated cost to maintain web page and print marketing materials

#### Revenue

Maximum Occupany	31
Foreigner Price	100
% of Foreigners	80%
Local Price	80
% of Locals	20%
Average Price	96

Figure 99: Revenue Assumptions for Managing the Mirabib Campsites

#### Revenue Assumptions:

1. Maximum Occupancy: recommended based on campsite sizes
2. Local and Foreigner separation in price, similar to park entrance fees

3. Appropriate price based on campsites in area with similar amenities
4. Projected more foreigners at the Mirabib Campsites than Locals

Avg Visitors Per Day	Revenue	Expenses	Accumulative		
			Year 1	Year 2	Year 3
1.0	\$ 35,040.00	\$ 75,190.00	\$ (40,150.00)	\$ (80,300.00)	\$ (120,450.00)
2.0	\$ 70,080.00	\$ 75,920.00	\$ (5,840.00)	\$ (11,680.00)	\$ (17,520.00)
3.0	\$ 105,120.00	\$ 76,650.00	\$ 28,470.00	\$ 56,940.00	\$ 85,410.00
4.0	\$ 140,160.00	\$ 77,380.00	\$ 62,780.00	\$ 125,560.00	\$ 188,340.00
5.0	\$ 175,200.00	\$ 78,110.00	\$ 97,090.00	\$ 194,180.00	\$ 291,270.00
6.0	\$ 210,240.00	\$ 78,840.00	\$ 131,400.00	\$ 262,800.00	\$ 394,200.00
7.0	\$ 245,280.00	\$ 79,570.00	\$ 165,710.00	\$ 331,420.00	\$ 497,130.00
8.0	\$ 280,320.00	\$ 80,300.00	\$ 200,020.00	\$ 400,040.00	\$ 600,060.00
9.0	\$ 315,360.00	\$ 81,030.00	\$ 234,330.00	\$ 468,660.00	\$ 702,990.00
10.0	\$ 350,400.00	\$ 81,760.00	\$ 268,640.00	\$ 537,280.00	\$ 805,920.00

Figure 100: Projected Profit for a 3-year Time Period

Projection Assumptions:

1. Constant visitor traffic for 3-year time period