



Integrating Solar into Nantucket's Historic Fabric

By: Kacie Miller, Shawn
Mills, Morgan Raposa,
Ben Twombly

An aerial photograph of a residential neighborhood. The central focus is a house with a grey shingled roof and a brick chimney. A large array of dark blue solar panels is installed on the roof, covering most of the surface area. To the left, another house with a similar roof style is visible. The background shows more houses, bare trees, and a clear blue sky. A dark semi-transparent overlay covers the bottom half of the image, containing text.

Goal of the Project

- **Develop recommendations and resources that the Town of Nantucket in collaboration with Nantucket Preservation Trust may use to encourage and assist in the permitting of solar technologies without compromising the island's historic and architectural character.**

What Is Driving Local Interest In Solar?

High Energy Costs

Energy Independence /
Grid Resiliency

Climate Consciousness

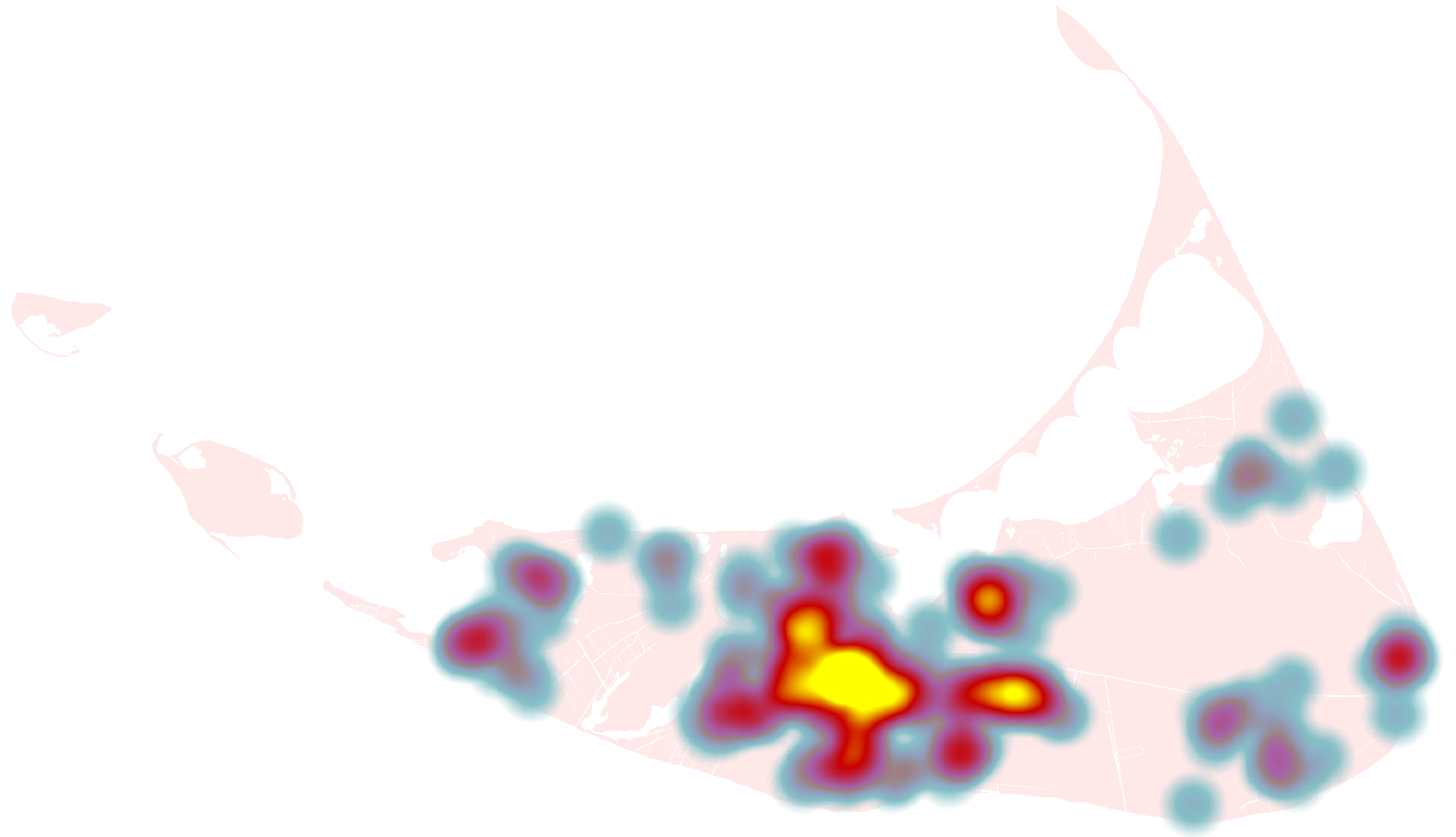

Heat map showing density of solar installations



Nantucket Peak Demand (MW)

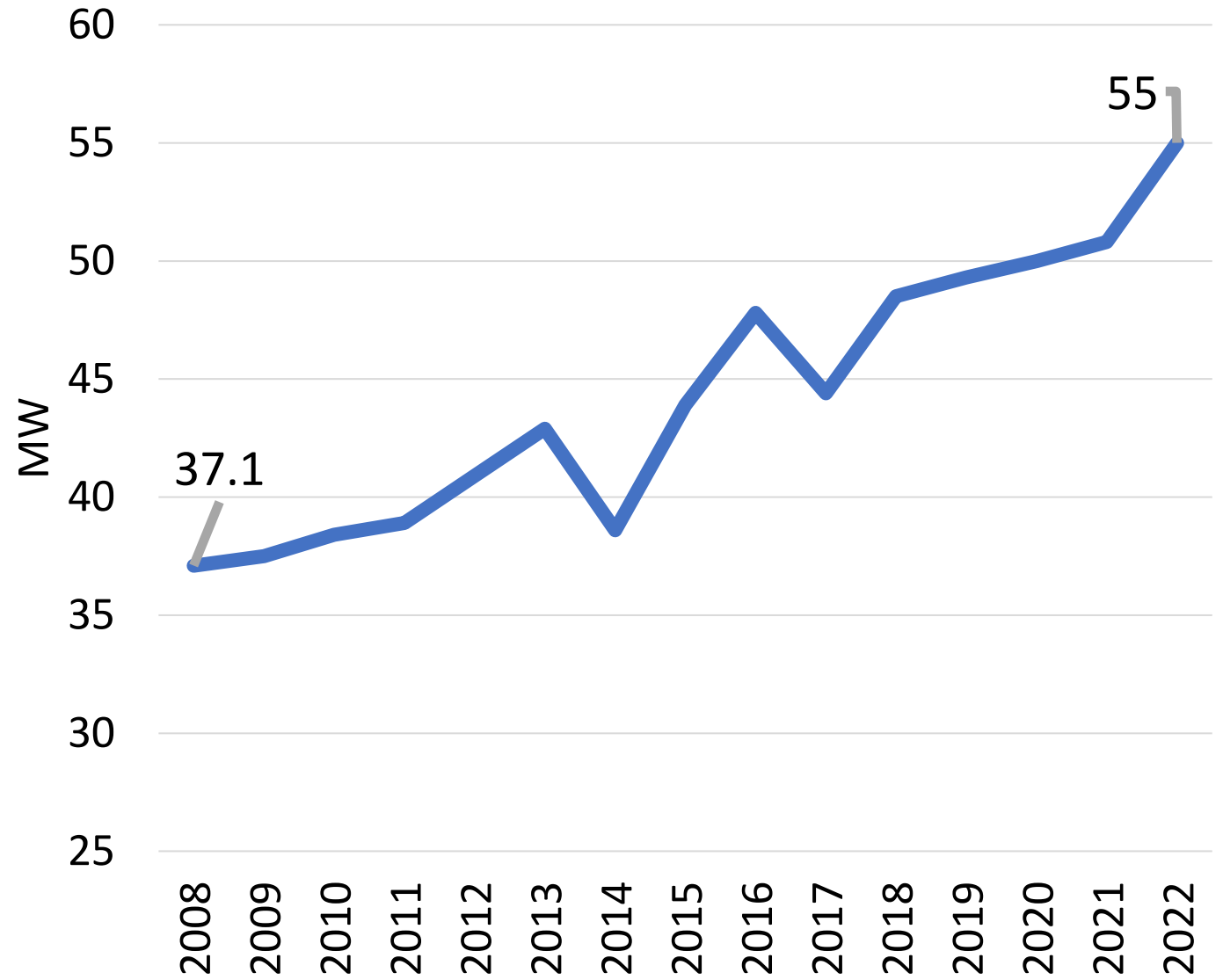

Solar Installations On Nantucket

- 200 Total Installations (Dec 2022)
- Steady Rise Annually
 - Peaking in 2020/21
- 1.9 MW of Total Installed Capacity

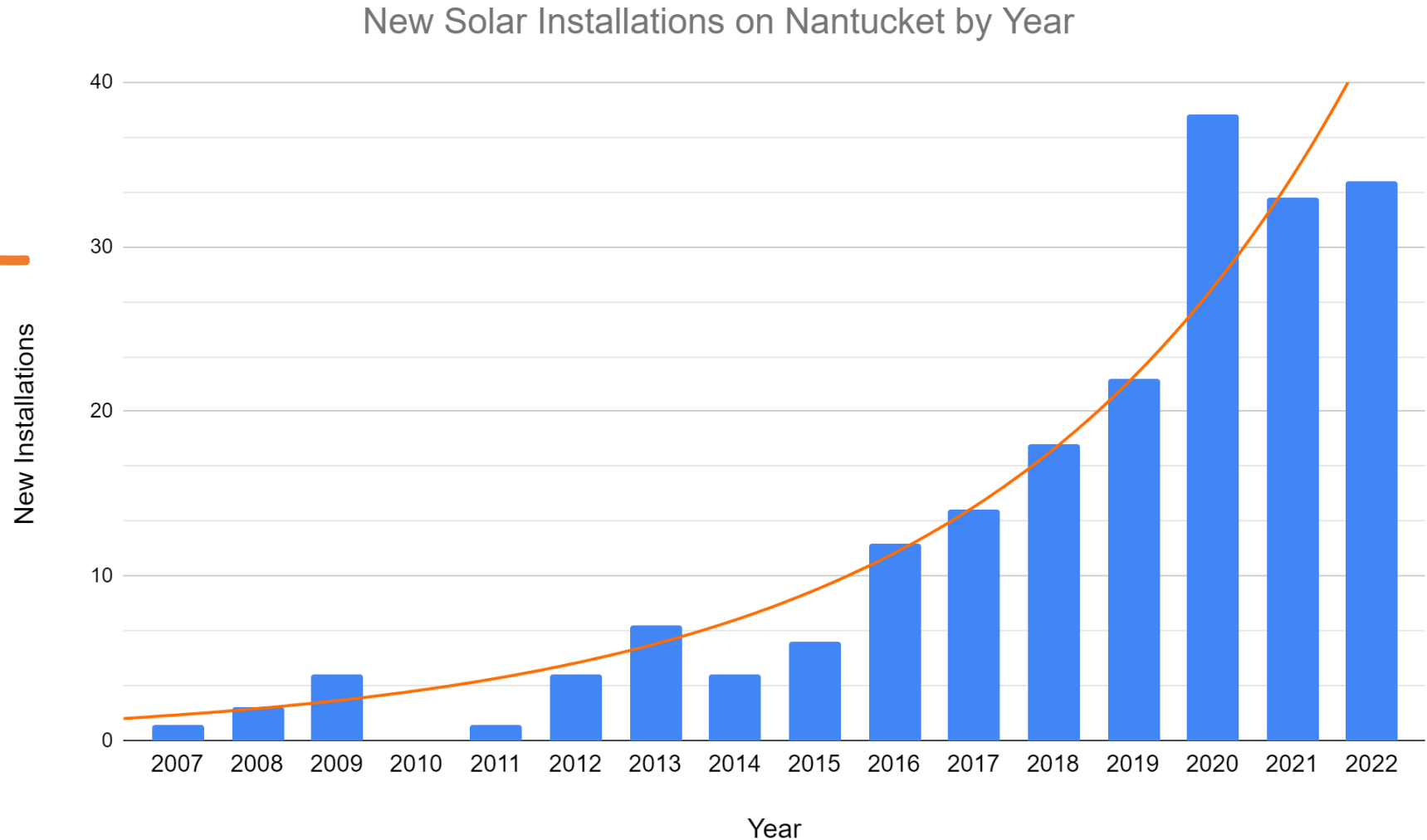

Methods

Analyzing other Historic District Commissions

Interviews

- Key Stakeholders
- Solar Installers
- Residents who have applied for solar
- Nantucket HDC Commissioner
- Nantucket Town Association

Surveyed Nantucket Residents



- Nantucket Civic League
- Short list of residents with solar installations

Other Historic District Solar Guidelines

Historic Districts

Map of the Historic District Commissions Researched

Legend

-  Explicit Solar Guidelines
-  Included as Equipment
-  None

Google Earth

Image U.S. Geological Survey
Image Landsat / Copernicus
Data SIO, NOAA, U.S. Navy, NGA, GEBCO

50 mi



Comparing Solar Guidelines

Unique Guidelines:

- **Sudbury and Provincetown mention the solar panel orientation**
- **Arlington (MA) has links to articles on solar panels on historic structures**
- **Providence has guidelines dependent on where you install your panels**

Salem Historic Commission's Solar Guidelines

Updated in 2022

Section on tips for applicants

Checklist of materials to be submitted

Multiple examples and diagrams

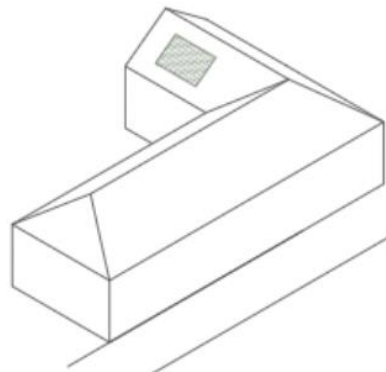

Locate solar panels on the roofs of side facades toward rear of the property.



Solar panels on a primary roof slope may be appropriate on a case-by-case basis to accommodate building-specific conditions. In this example, the building's original balustrade will be recreated and will screen the solar panels from the street.



Appropriate installations balance functionality with aesthetics and minimize the appearance of solar panels through color, placement, and continuity of the roof plane.

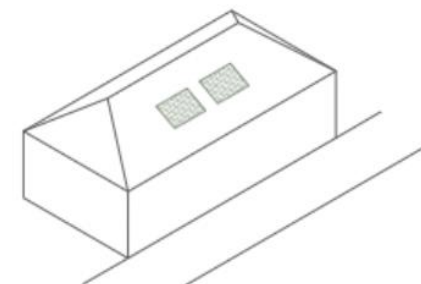

Avoid locating solar panels on the roof facing the street or main facade without appropriate screening.

Perspectives from other HDCs

- Their guidelines were created due to rise in demand for solar panels
- They are all open to solar roof shingles
- In the last 3 years:

Historic District	Applications Processed
Northampton, MA	3 – 5
Sudbury, MA	3 – 5
Salem, MA	5 – 10
Providence, RI	30 – 50

Nantucket has approved 111 solar installations in the last 3 years



Perspectives of Key Stakeholders

Perspective of Solar Installers

Demand for solar panels has steadily increased in the last 5 years

70 – 90% of solar installations are roof mounts

Ground mounts are about 15% more expensive than roof mounts

They prescreen potential clients

They usually complete 1 revision per project

Perspective of a Nantucket HDC Commissioner

Appropriately integrating solar technology is a challenge

The current solar roof shingles are too reflective and don't fit with the general aesthetic of Nantucket

They are open to looking at emerging solar technologies

They are transitioning from paper to digital application

Perspective of Solar Applicants

Most felt the current guidelines were not fair enough

Many were unfamiliar with the application process

All agreed that a checklist and a guide to going solar would be very useful

Community Survey

Nantucket Solar Guidelines Survey

We are a group of students from Worcester Polytechnic Institute conducting a research project in collaboration with the Town of Nantucket and Nantucket Preservation Trust to identify ways to improve local solar permitting, including the HDC approval process.

This survey is estimated to take approximately 5-10 minutes. You may skip any questions you prefer not to answer, and you may withdraw at any time. The survey is anonymous – we will not be collecting your name or any personal, identifying information.

Your participation is greatly appreciated. If you have any questions about our research, or would like a copy of the published report, please contact us at gr-ack22-solar@wpi.edu, or our faculty advisors, Dominic Golding, at golding@wpi.edu or Bruce Bursten, at bbursten@wpi.edu.

Choose which best describes your residency status on Nantucket.

- I am a year-round homeowner
- I am a year-round renter
- I am a seasonal homeowner
- Other: _____

Current Guidelines (n=201)

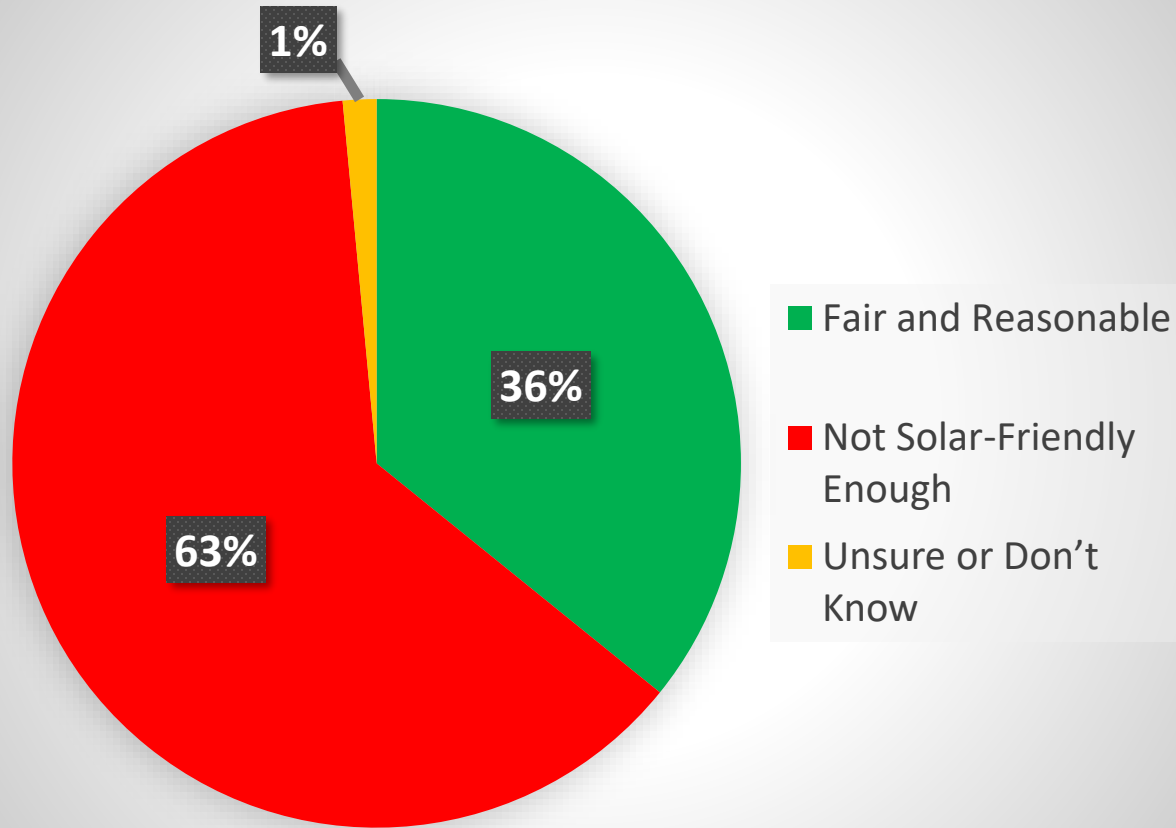

- Most respondents feel guidelines are not solar friendly enough

Panels Should Not be Visible Outside The Two Old Historic Districts (n=203)

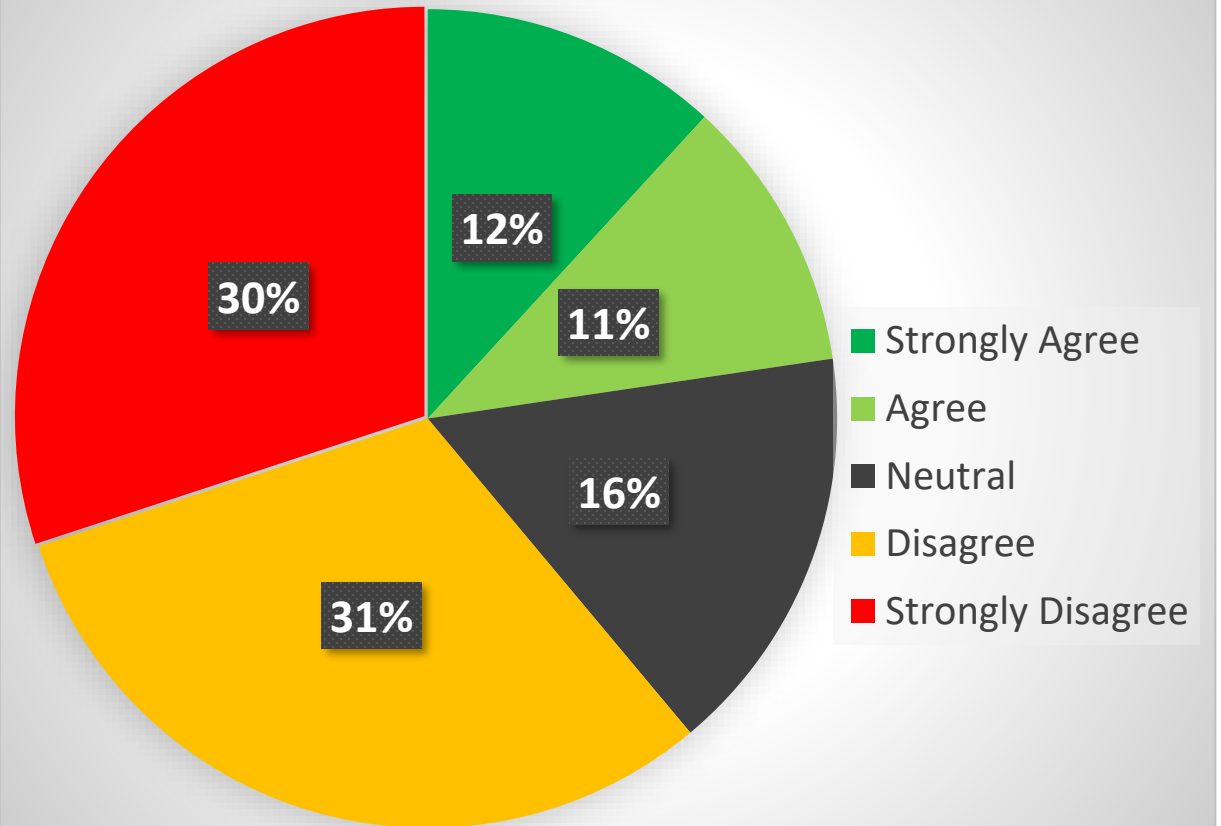

- Most respondents feel solar panels should be visible outside of the two Old Historic Districts

There Should be More Solar on Nantucket (n=203)

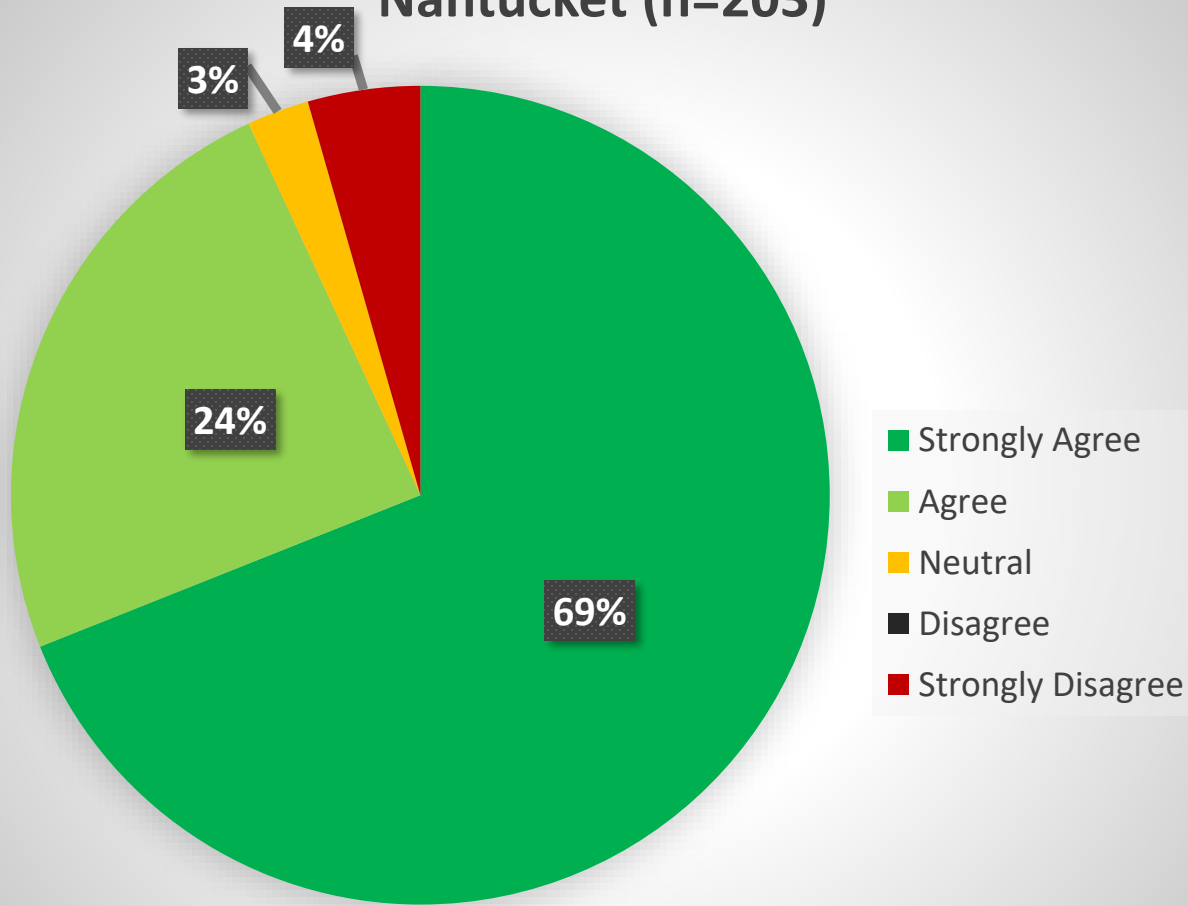

- Overwhelming support for more solar

Interest in Installing Solar (n=201)

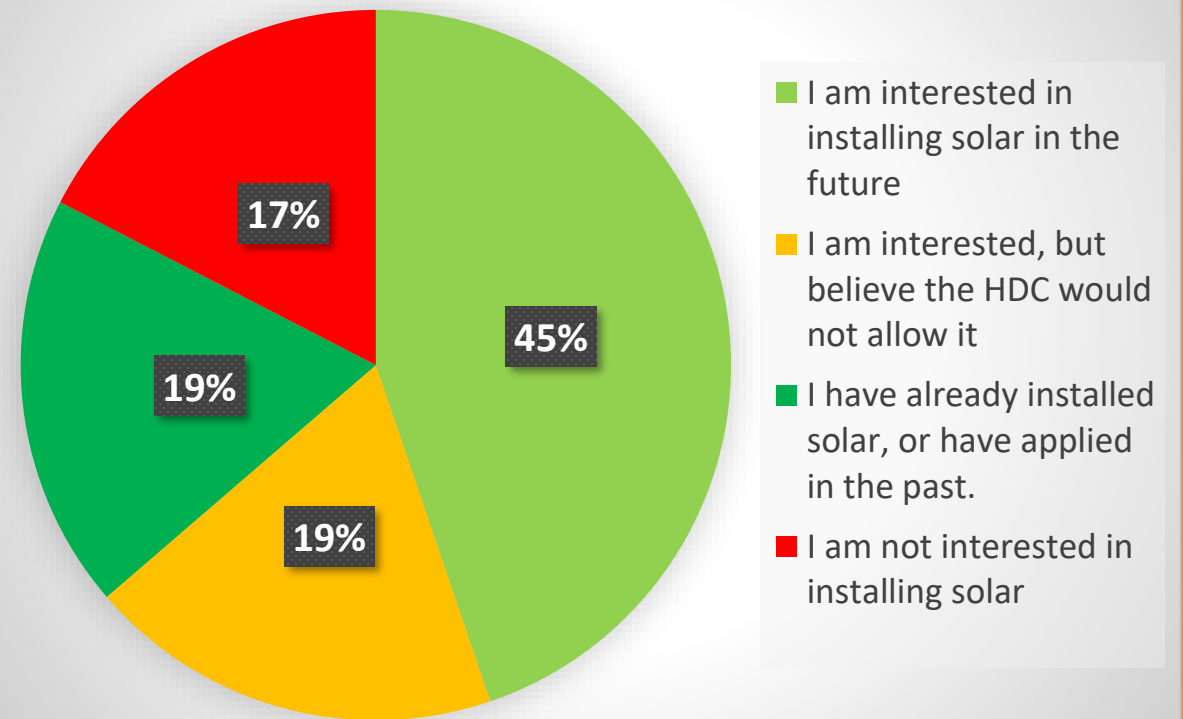

- Overwhelming interest in solar installations

Sample Open Response

Experience with HDC During Application Process

Positive

- Appropriate
- Pretty simple, we had the ideal site for the panels on our barn roof which wasn't visible from the street
- Overall fine but a bit picky about visibility from the street. The only way the panels can be seen is if you stop and look for them. Not likely visible from a passing car.

Neutral

- No issues, but our installation happens to not be visible from a public way
- [Installer] dealt with all HDC matters

Negative

- Irritating
- Tedious

Interactive Solar Map Improvement

Explore Possible Improvements

- Google Maps based system
- Isolation from other map resources
- Inconsistent update process

New Solar Map Layer

- Arc-GIS based layer
- Integration with other GIS resources
- Partial update automation

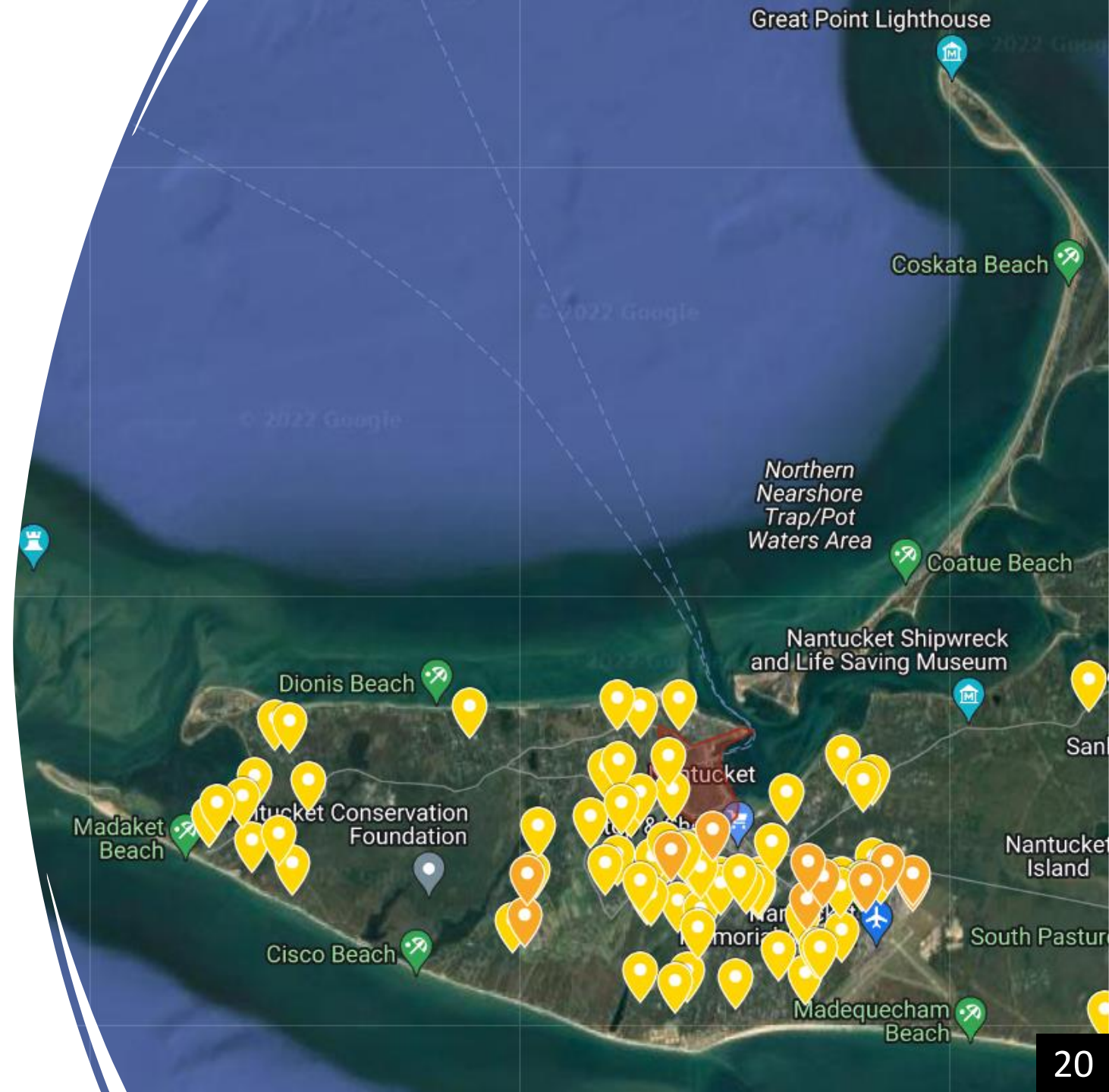

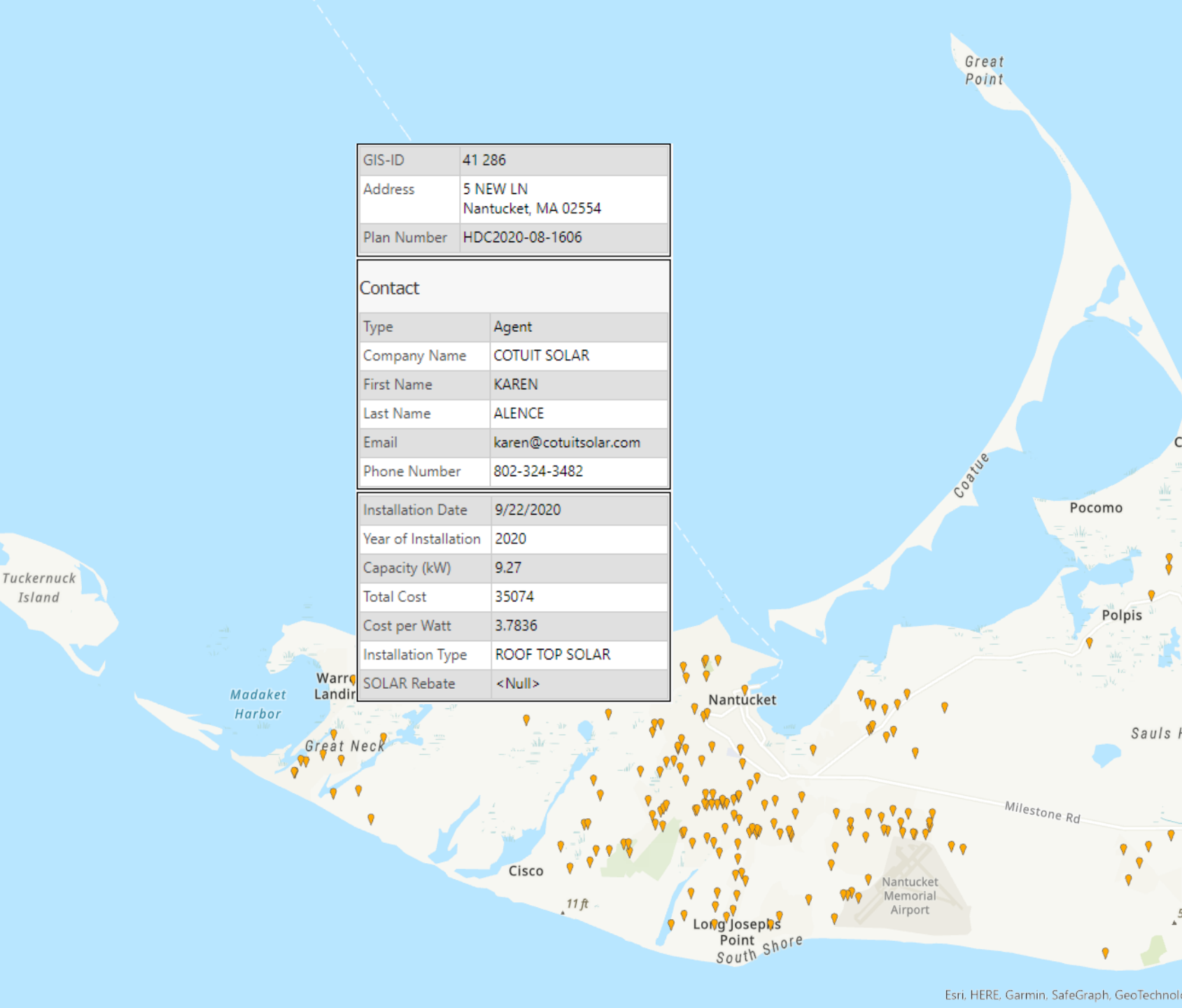

New Solar Map Layer

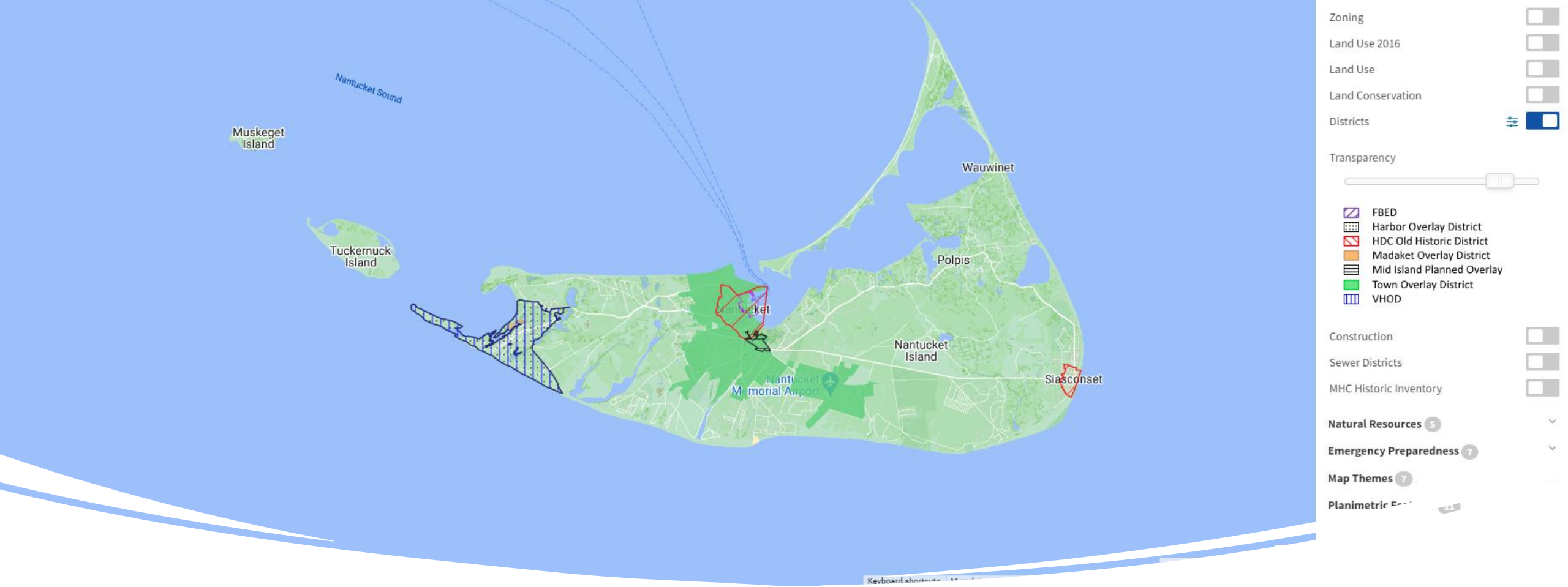

Nantucket GIS | MapGEO

- One combined location for Nantucket's various mapping resources
- Improved modern user interface

Update Process Automation

EnerGov Searches



Python Script



Output Table | Manual Addition



Marker Layer Creation (GIS Coordinator)



MapGEO

Recommendations

Pursue Survey & Planning Grant from Massachusetts Historical Commission

Transition to a more online permitting system to reduce the paper requirements during the application process

Renewed focus on data entry and organization in the EnerGov system

A GUIDE TO GOING SOLAR

GOING SOLAR IN FRAMINGHAM

Our sponsors collaborate to create educational resources including:

- **An online guide to going solar**
- **A solar permitting checklist**
- **Compiling a slideshow of images to show what kinds of installations the HDC has approved**
- **Continuing updating the solar map to display the current status of solar installations on island**

1) Get an Energy Audit

2) Learn About Solar

3) Evaluate Your Site

4) Obtain Bids and Find Installer

5) Complete Permitting, Installation, and Inspection

6) Connect to the Grid

GET AN ENERGY AUDIT

The process of sizing a solar energy system for your home or business is largely guided by the electricity use that it will support. Learning about your current electricity use, including the rate you pay for your electricity and the amount of kilowatt-hours that you use will help determine the appropriate size of your solar energy system.

Understanding your electricity use is important for another reason; one of the most important steps in evaluating a potential solar energy project is considering whether there are energy efficiency improvements that could be made first. Energy efficiency is often the most cost-effective way to make economical and environmentally-friendly improvements to your home or business. Improving the energy efficiency of your home or business first will help ensure that any future solar energy system is sized correctly and may help save on up-front equipment and installation costs.



Getting a free energy audit from Mass Save will not only help you to evaluate the energy efficiency of your building, it helps you learn if you are qualified for rebates and incentives to do energy efficiency projects.

Acknowledgements

Lauren Sinatra, our sponsor from the Town of Nantucket Energy Office.

Holly Backus, our sponsor from the Town of Nantucket Planning Office.

Mary Bergman, our sponsor from the Nantucket Preservations Trust.

Nathan Porter, GIS Coordinator, for his help in navigating the Arc-GIS software

Molly Sprouse, IT Technician, for her help in navigating the EnerGov system

The Nantucket HDC Commissioner who provided insight regarding the guidelines surrounding solar PV.

Peter Morrison, for distributing our survey to the Nantucket Civic League

ACK Smart, Cotuit, and Sunwind for taking the time to speak with us.

All the Nantucket residents who applied for a COA who spoke to us about their experience.

The Nantucket Yacht Club for housing us and Young's Bicycle shop for loaning bicycles for our time on island.

Our advisors Dominic Golding and Bruce Bursten.



Thank You!
Any Questions?
