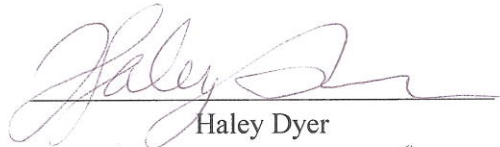
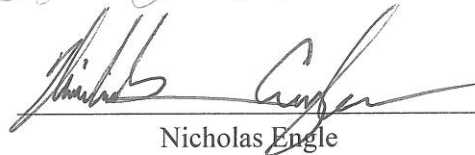

Alternative Gravity Load Resisting System Design for Clark University's Alumni & Student Engagement Center

A Major Qualifying Project
Submitted to the Faculty of
WORCESTER POLYTECHNIC INSTITUTE
In Partial Fulfillment of the Requirements for the
Degree of Bachelor of Science in Civil Engineering

Submitted on March 22, 2016 by:

Haley Dyer

Nicholas Engle

Ronelle LeBlanc

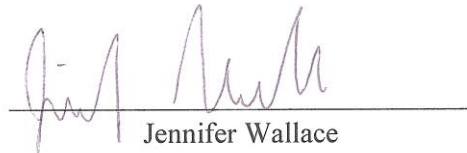
Jennifer Wallace

Project Advisors:

Professor Leonard Albano

Professor Guillermo Salazar

This report is the product of an education program, and is intended to serve as partial documentation for the evaluation of academic achievement. The report should not be construed as a working document by the reader

Abstract

Clark University is currently building the Alumni and Student Engagement Center on Main Street in Worcester, MA. This report explores a Girder-Slab structural floor framing system for this building. Using Building Information Modeling software, a five-dimensional model of the building is developed to support the alternative design and associated construction planning. Additionally, the impact of Requests for Information on the management process is investigated. The Girder-Slab design was found to be a time and cost efficient alternative design.

Acknowledgements

Our team would like to acknowledge and thank all of the individuals who have helped us on this project over the past eight months. Our project's success would not have been possible without their contributions.

We would first like to thank our sponsors, **Clark University** and **Consigli Construction**, specifically Consigli's liaisons, **Mr. William O'Rourke**, **Mr. Richard Scopelliti** and **Mr. Patrick Condon**, for their support and assistance with our project. **Mr. William O'Rourke**, the project executive, made it possible for us to work on this project. We appreciate this opportunity to attend owner's meetings and gain access to the construction documents for the project.





Furthermore, we would like to thank **Ms. Maria Gomez Lara**, a graduate student at Worcester Polytechnic Institute, for her assistance with creating our 3D model using *Autodesk Revit 2016*. We greatly appreciate the time she has given us and her valuable advice.

Additionally, we would like to thank **Mr. Daniel Fisher** from Girder-Slab Systems for his assistance with creating our new Girder-Slab floor framing design.

We would, finally, like to thank our advisors **Professor Leonard Albano, PhD** and **Professor Guillermo Salazar, PhD** from Worcester Polytechnic Institute. Their constant feedback was invaluable and helped us make our project the very best that it could be. We genuinely appreciate all the hours that they have spent reading and editing our report. We would like to acknowledge that we could not have succeeded without their unending support and assistance.

Authorship Page

Section	Author
Abstract	All
Acknowledgements	Haley Dyer, Jennifer Wallace
Chapter 1 Introduction	All
Chapter 2 Background	All
2.1 Alumni & Student Engagement Center	All
2.2 Floor Framing Systems	Ronelle LeBlanc
2.3 Structural Design	Ronelle LeBlanc & Nicholas Engle
2.4 Project Management	Haley Dyer & Jennifer Wallace
Chapter 3 Design of an Alternative Floor Framing System	Ronelle LeBlanc
Chapter 4 Design of the Alternative Weather-Exposed Column Connections	Nicholas Engle
Chapter 5 Cost Estimates	Jennifer Wallace
Chapter 6 Girder-Slab Project Schedule	Haley Dyer
Chapter 7 Current & Alternative Design 5D Models	Haley Dyer
Chapter 8 Project Communication Through Request for Information	Jennifer Wallace
Chapter 9 Conclusions	All
Appendices	All

Capstone Design Statement

The Alumni and Student Engagement Center will serve as Clark University's new campus center after its completion in June of 2016. This Major Qualifying Project (MQP) proposes an alternative floor framing system and analyzes exposed column connections based off of the original building structure. To complement the alternative designs, a corresponding schedule and cost estimate were generated. This work was supported by the use of design, structural analysis, and construction project management application software, as well as Building Information Modeling tools.

The proposed design addresses the following construction and design constraints: economic, constructability, health and safety, social, and ethical.

Economic

The economic impact was addressed by creating and comparing a cost estimate and schedule for both the current and alternative design of the building, taking into account the changes in the materials and structural designs.

Constructability

Constructability was met through ensuring that the alternative design complied with the same loading and size constraints as the current design. Building Information Modeling (BIM) design software was used to visually confirm the new steel structure design. BIM was also used for analysis of the schedules and cost estimates for the two building designs.

Health and Safety

Health and Safety constraints were met through applying building and zoning codes to the alternative design. These constraints were also met by following the ASCE 7 design standards as well as the AISC Specifications.

Social

Social constraints were met through attending owner's meetings and learning about the challenges of constructing a building on land shared by two owners, Saint Peter's Catholic Church and Clark University. This was also met because the building maintains an open concept which promotes connections between students and alumni. The open concept impacts the design of the building by creating larger loading conditions and increasing diversity in beam sizes.

Ethical

Ethical constraints were addressed through respecting both Clark University's and Consigli Construction's confidentiality. This was met by withholding sensitive information from the report.

Professional Licensure Statement

A Professional License is a document of verification that demonstrates that the engineer has exceptional skills and certification to perform his or her practice (NCEES, 2015). According to the National Council of Examinations for Engineering and Surveying, NCEES, professional licensure protects the public by enforcing standards that restrict practice to qualified individuals who have met specific qualifications in education, work experience, and exams (NCEES, 2015).

Although requirements vary from state to state, candidates must complete a series of steps to be fully licensed as a Professional Engineer. The first step that the National Society of Professional Engineers recommends is to successfully complete the Fundamentals of Engineering, FE, exam after completing an ABET-accredited, undergraduate engineering degree. Upon passing the FE exam, the candidate is certified as an Engineer In Training, EIT, also known as an Engineering Intern, EI (Careers, 2015). With this certification, the engineer in training can begin working as a civil engineer under the supervision of a Professional Engineer. An EIT or EI must typically have four years of experience as an engineer before taking the Principles and Practice of Engineering, PE, exam. After successfully completing the PE exam, the candidate becomes certified as a Professional Engineer. For the candidates who wish to specialize in structural engineering, some states require them to take the two-day Structural Engineering Exam, SE (Careers, 2015).

Obtaining professional licensure is viewed as a distinguished achievement and a prestigious title by clients, government, employers, and the public. Obtaining this license shows responsibility and authority because only Professional Engineers can “offer services to the public, be principal of a firm, perform consulting services, bid for government contracts, and

stamp and seal designs,”(NCEES, 2015). Those who have achieved licensure will also be able to enjoy the professional benefits that accompany this distinction.

This project contains a significant design component complemented by the project management analysis for Clark University’s Alumni and Student Engagement Center. The completion of this MQP is a requirement for earning an engineering degree at WPI which is a requirement for obtaining a Professional Licensure. This significant design experience has provided a realistic knowledge to apply concepts learned in class to a real-world project.

Table of Contents

Abstract	ii
Acknowledgements	iii
Authorship Page	iv
Capstone Design Statement	v
Professional Licensure Statement	vii
Table of Contents	ix
List of Figures	xii
List of Tables	xiii
List of Equations	xiv
1 Introduction	1
2 Background	3
2.1 Alumni & Student Engagement Center	3
2.2 Floor Framing Systems	4
2.2.1 Slab-on-Metal Decking	4
2.2.2 Girder-Slab	5
2.3 Structural Design	7
2.3.1 8th Edition of Massachusetts State Building Code	7
2.3.2 Design of Girder-Slab System	9
2.3.3 Design of Baseplates and Footing for Steel Columns Exposed to Weather.	14
2.3.4 Footing Design	19
2.4 Project Management	21
2.4.1 Construction Cost Estimating	21
2.4.2 Construction Scheduling	22
2.4.3 Project Communication	23
2.4.4 Lean Construction	25
2.4.5 Software Tools Used	26
3 Design of an Alternative Floor Framing System	30
3.1 Loading Combination Calculation Process	30
3.2 D-Beam Selection	32
3.3 D-Beam Selection Outcomes & Analysis	35

3.4 W-Shape Selection Process.....	39
3.5 W-Shape Selection Outcomes & Analysis.....	40
3.6 Angle Section Selection Process.....	41
3.7 Angle Section Selection Outcomes & Analysis.....	44
4 Design of the Alternative Weather-Exposed Column Connections.....	46
4.1 Structural Analysis Process.....	46
4.2 Outcomes & Analysis.....	50
5 Cost Estimates.....	54
5.1. Cost Estimate Preparation for the Existing Structural Systems.....	55
5.2. Cost Estimate Preparation for the Girder-Slab Design.....	55
5.3 Cost Estimate Outcomes.....	56
6 Girder-Slab Project Schedule.....	60
6.1 Scheduling Process.....	60
6.2 Scheduling Outcomes.....	62
7 Current & Alternative Design 5D Models.....	65
7.1 Current Building Revit Model Process & Outcome.....	65
7.2 Girder-Slab Building Design Revit Model Process & Outcome.....	68
7.3 Implementation 5D Models (Project Schedule and Cost Estimate) in <i>Navisworks</i>	71
7.4 Final 5D Model Rendering Process & Outcome.....	71
8 Project Communication Through Requests for Information.....	80
8.1 Owner’s Meetings.....	80
8.2 RFI Analysis.....	80
9 Conclusions.....	85
References.....	86
Appendices.....	88
All Appendices are electronic files that can be found in the “Appendices zip-folder.”.....	88
Appendix A Final Loading Combination Results.....	88
Appendix B Final Girder-Slab Results.....	88
Appendix C Final W Shape Selection Results.....	88
Appendix D Sample Angle Section (L-shape Hand Calculations).....	88
Appendix E Final Angle Section Selection Results.....	88
Appendix F Hand Calculations for Steel Baseplate Selection.....	88
Appendix G Foundation Cost Estimate.....	88

Appendix H Slab-On-Metal Decking Cost Estimate..... 88
Appendix I Steel Cost Estimate 88
Appendix J Precast Concrete Planks Cost Estimate 88
Appendix K Explanation of D-beam Cost 88
Appendix L Current Building Design Schedule..... 88
Appendix M Girder-Slab Building Design Schedule 88
Appendix N Current Building Design Revit Model 88
Appendix O Girder-Slab Building Design Revit Model 88
Appendix P Current Building Design BIM Model..... 89
Appendix Q Girder-Slab Building Design BIM Model 89
Appendix R RFI Analysis..... 89
Appendix S MQP Gantt Chart 89
Appendix T MQP Proposal..... 89

List of Figures

<i>Figure 1 Slab-on-metal decking in the ASEC</i>	5
<i>Figure 2 D-Beam Web Sections (Stein, 2008)</i>	6
<i>Figure 3 Tributary Width Definition Visual</i>	10
<i>Figure 4 Wind Design Zones on a Flat Roofed Building</i>	16
<i>Figure 5 Footing Base Design</i>	20
<i>Figure 6 Visualization of Different Loadings Acting on a Beam</i>	31
<i>Figure 7 Loading Combination Excel Sheet Heading</i>	31
<i>Figure 8 Girder-Slab Design Tool Screenshot</i>	34
<i>Figure 9 Second Floor Girder-Slab Floor Framing System Configuration</i>	35
<i>Figure 10 Third Floor Girder-Slab Floor Framing System Configuration</i>	36
<i>Figure 11 Fourth Floor Girder-Slab Floor Framing System Configuration</i>	37
<i>Figure 12 Exterior Beam Design with Angle Sections</i>	42
<i>Figure 13 Angle Section Configuration Example</i>	45
<i>Figure 14 Free Body Diagram of Loads Acting on Columns</i>	48
<i>Figure 15 Steel Baseplate</i>	51
<i>Figure 16 Cost Estimate Process Flowchart</i>	54
<i>Figure 17 Floor Framing System Schedules</i>	61
<i>Figure 18 Floor Framing System Schedules Comparison</i>	63
<i>Figure 19 On-Screen Takeoff 3 Measurement Example</i>	66
<i>Figure 20 Structural Steel Framing Material Schedule</i>	67
<i>Figure 21 Current Building Design Revit Model</i>	67
<i>Figure 22 Current vs. Girder Slab Building Design Level 4</i>	69
<i>Figure 23 Precast Concrete Planks Layout for Level 3</i>	70
<i>Figure 24 Girder-Slab Building Design Schedule Example</i>	71
<i>Figure 25 Current vs. Girder-Slab Building Design Week 1</i>	72
<i>Figure 26 Current vs. Girder-Slab Building Design Week 4</i>	72
<i>Figure 27 Current vs. Girder-Slab Building Design Week 8</i>	73
<i>Figure 28 Current vs. Girder-Slab Building Design Week 11</i>	73
<i>Figure 29 Current vs. Girder-Slab Building Design Week 13</i>	74
<i>Figure 30 Current vs. Girder-Slab Building Design Week 14</i>	75
<i>Figure 31 Current vs. Girder-Slab Building Design Week 15</i>	76
<i>Figure 32 Current vs. Girder-Slab Building Design Week 16</i>	77
<i>Figure 33 Current vs. Girder-Slab Building Design Week 20</i>	78
<i>Figure 34 Current vs. Girder-Slab Building Design Week 23</i>	79

List of Tables

<i>Table 1 Structural Design Values for the City of Worcester, MA</i>	8
<i>Table 2 Units of Loading Combination Equation Values</i>	10
<i>Table 3 Net Wind Design Pressure Variable Table</i>	15
<i>Table 4 Steel Baseplate Design Values</i>	16
<i>Table 5 Functions of Project Management ("Planning, Scheduling and Construction Management," 2014)</i>	22
<i>Table 6 Common Topics of Discussion at OAC Meetings (Radosavljevic et al., 2012)</i>	24
<i>Table 7 Types of Loads</i>	32
<i>Table 8 D-Beam Size & Quantities</i>	38
<i>Table 9 W-Shape Selection Results</i>	40
<i>Table 10 Canopy Loads</i>	47
<i>Table 11 Wind Loads</i>	47
<i>Table 12 LRFD Loading Combinations Acting on the Columns</i>	49
<i>Table 13 Variable Used in Metal Baseplate Design</i>	50
<i>Table 14 Steel Plate Dimensions</i>	50
<i>Table 15 Original Steel Plate Dimensions</i>	51
<i>Table 16 Pier Dimensions</i>	52
<i>Table 17 Cost Estimate of Current Design vs. New Design</i>	57
<i>Table 18 Foundation Cost Estimate by Phase</i>	57
<i>Table 19 Steel Cost Estimate by Level</i>	58
<i>Table 20 Concrete Flooring Cost Estimate by Floor</i>	59
<i>Table 21 RFI Sorting Format</i>	81
<i>Table 22 RFI Delay Tracking</i>	82

List of Equations

<i>Equation 1 Loading Combination Equation</i>	8
<i>Equation 2 Loading Combination Equation</i>	11
<i>Equation 3 Noncomposite/composite Moment</i>	11
<i>Equation 4 Design Moment Capacity</i>	12
<i>Equation 5 Vertical Shear Capacity</i>	12
<i>Equation 6 Average Factored Vertical Shear</i>	12
<i>Equation 7 Shear Strength of Full Composite Section</i>	13
<i>Equation 8 Deflection Due to Live Load</i>	13
<i>Equation 9 Strain at the Bottom of the Flange</i>	14
<i>Equation 10 Net Wind Design Pressure</i>	15
<i>Equation 11 Factored Axial Load</i>	17
<i>Equation 12 Wind Load</i>	17
<i>Equation 13 Moment due to Lateral Loads</i>	17
<i>Equation 14 Eccentricity</i>	17
<i>Equation 15 Stress in Baseplate due to Axial Load</i>	18
<i>Equation 16 Moment on Column</i>	18
<i>Equation 17 Geometric Property</i>	18
<i>Equation 18 Average Resulting Stress in Baseplate</i>	18
<i>Equation 19 Moment in Transverse Direction</i>	18
<i>Equation 20 Thickness of Baseplate</i>	19
<i>Equation 21 Required Footing Area</i>	19
<i>Equation 22 Moment using Load and 1/3 footing Base Length</i>	20
<i>Equation 23 Max Soil Pressure Check</i>	21
<i>Equation 24 Loading Combinations Equation for DL, LL, & Snow (in lb/ft)</i>	39
<i>Equation 25 Plastic Section Modulus Limit</i>	39
<i>Equation 26 Loading Combinations Equation for DL, LL, & Snow (in lb/ft)</i>	43
<i>Equation 27 Design Moment</i>	43

1 Introduction

To promote engagement among students, alumni, and faculty, Clark University is building a new Alumni and Student Engagement Center (ASEC). The ASEC, located on Main Street in Worcester, Massachusetts, is currently being constructed by Consigli Construction of Milford, Massachusetts. Architerra, Inc. is the architectural firm who designed the building and Odeh Engineering is the engineering firm who designed the building's structural components. The building will serve as a collaboration center where alumni can communicate with undergraduate students on projects that involve the local community. The ASEC will be a headquarters for Clark University's Liberal Education & Effective Practice, LEEP, program which allows students to create a positive impact on their community using the knowledge gained from classwork. After completion of construction, this building's design will be recognized for its effective and sustainable building strategies and techniques by receiving a Leadership in Energy and Environmental Design, LEED, Platinum certification.

The goal of this Major Qualifying Project, MQP, is to develop an alternative gravity load resisting system while considering the impacts of this structural design on the cost and the schedule of the project. A new Girder-Slab floor framing system was created as a proposed design for comparison to the current slab-on-metal decking floor framing system. Throughout the paper the original design will be referred to as either "current design" or "slab-on-metal decking building design" and the new design will be referred as either "alternative design" or "Girder-Slab building design". To gain knowledge about the construction process of Clark's ASEC, owner's meetings were attended. This knowledge was used to discover the impacts of RFI's on the management process. Architecturally Exposed Structural Steel (AESS) columns are

found outside the front entrance of the building. Revised base connections for the AESS columns were designed to explore the impacts of a fixed design versus the current design. Cost estimates were created for both the current and alternative designs of the foundations and floor framing systems. A project schedule for the Girder-Slab floor framing system was developed. Lastly, two visual five-dimensional models were developed using Building Information Modeling (BIM) software tools for both the current and alternative design, incorporating their respective cost and schedule. This project determined that the Girder-Slab floor framing system was cost effective and time efficient while maintaining the structural integrity of the building.

2 Background

There are a variety of design and construction methods being used in industry today, some methods more common than others. Clark University's ASEC uses a standard slab-on-metal decking flooring design and AESS pinned columns, a less common column design. Construction management techniques are therefore standard for constructing the floor framing systems, and the AESS columns introduce specific requirements to the standard practices for contracting structural steel. In this chapter, we will provide some background on the structural and construction management aspect of these designs. We will also explore background information on the Girder-Slab floor framing system, as we plan to use this flooring system to create an alternative design to the current slab-on-metal decking flooring system.

2.1 Alumni & Student Engagement Center

Clark University's Alumni & Student Engagement Center will serve as a place for academic and professional development to welcome both current and graduated students. Clark University desires to expand their campus to provide a larger space for their students and alumni to engage amongst one another. This prominent building is located on the opposite side of Main Street from the rest of the campus and shares a parking lot with the neighboring Saint Peter's Catholic Church.

This building will also serve as a headquarters for Clark University's Liberal Education & Effective Practice, LEEP, efforts. LEEP is the University's way to connect their students' liberal studies with real-world problems. LEEP projects are able to be completed by seniors in good academic standing. Projects are completed at off-site non-profits and must respond to the needs of the host organization. The old LEEP center was located in a building that houses a

number of other departments. By moving the location of the LEEP center into the ASEC, Clark University is building a greater focus on LEEP for students and alumni.

The ASEC was designed to promote communication between alumni and students. One way to ensure that this happens is to implement a floor framing system that allows for larger, open areas. The current design accomplishes that goal by using a common type of floor framing system, slab-on-metal decking. The alternative Girder-Slab floor framing system design also satisfies that requirement, by allowing for greater open spaces.

2.2 Floor Framing Systems

This section provides a detailed explanation of the existing slab on metal decking and the alternative Girder-Slab floor framing systems.

2.2.1 Slab-on-Metal Decking

The current flooring system in the ASEC consists of slab-on-metal decking floor framing system, which involves four main elements: metal decking, mesh reinforcement, concrete slabs and shear connectors. The metal decking in the ASEC is three inches deep and spans from beam to beam. The metal decking sits on top of the beams, with the corrugated valleys running perpendicular to the beams. The metal decking is connected to the beam with screws, fasteners or welds. The mesh reinforcement is then laid on top of the metal decking (Porter & Ekberg Jr., 1975). This mesh reinforcement is 6X6 W2.9X2.9, meaning the mesh creates six inch by six inch squares and the area of the rebar's cross section is 0.029 inches squared. The concrete slab on top of the connectors, decking and mesh reinforcement is five inches thick. The concrete has a 28-day compressive strength of 4000 psi and is lightweight. Figure 1 is taken from the construction of the ASEC as an example of slab-on-metal decking.



Figure 1 Slab-on-metal decking in the ASEC

2.2.2 Girder-Slab

The Girder-Slab System is used in construction as a floor framing system. Materials used in the system are prefabricated off-site which makes for efficient construction. The main components of the Girder-Slab System are structural steel and precast hollow-core slabs (Stein, 2008). During the fabrication process, slabs are connected to the structural steel with cementitious grout to maintain the shape and hold the slabs in place. A unique component to this flooring system is the open-web dissymmetric beam, often referred to as a “D-beam” (Stein, 2008). A D-beam is structural steel that supports precast, prestressed hollow core slabs on the lower flange. Often beams are cut in half and then corrugated to allow for grout to flow through the opening in the web. Figure 2 below shows typical D-beam section cuts.

THIS SPACE HAS BEEN INTENTIONALLY LEFT BLANK

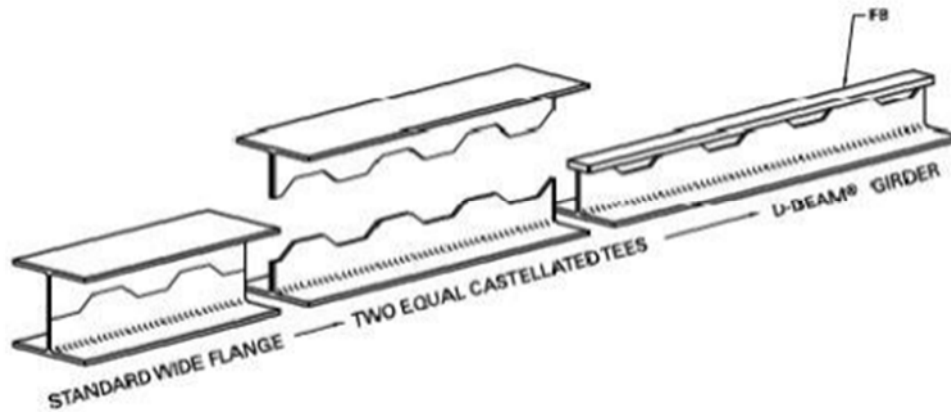

Figure 2 D-Beam Web Sections (Stein, 2008)

From the figure above, you'll notice that the cuts in the web may separate to allow for more or less grout flow. The distance between the cut ends of the beam will not only affect the strength of the D-beam, but also the thickness of the floor. It's very important that the D-beam's cut is balanced for both thickness regulations and structural integrity.

Steel fabricators make D-beams in their own shops but the lead time is no different than for a conventional steel job (Fisher, 2105). Lead time is defined as how long it takes to design, fabricate, and deliver materials. Installing precast planks can take approximately one day to set 6,000 to 10,000 square feet according to Mack Industries Inc. (Mack Industries, 2015). This company specializes in installing planks for Girder-Slab systems and was referred by The Girder-Slab System. The installation time also is dependent on the weather conditions, type of structure, plank elevation, site conditions, and set start time. Mack Industries also predict that the grouting process requires an additional day per 24,000 square feet of planking. The planks can be set on the steel immediately after the steel is completely secured (Mack Industries, 2015). Once fabrication has proceeded on the D-beam and precast system, any changes to the structure will cause further delays as fabrication will have to stop.

The ASEC's current slab-on-metal decking floor framing system is a very common system used for the construction of steel-framed buildings all over the country. A steel frame and metal deck system allows for more flexibility with any changes to the mechanical shafts, elevator size changes, room shifting, etc. The current floor framing system at the ASEC was constructed on-site and integrated within the overall construction process. The Girder-Slab floor framing systems are becoming more well-known, but are not as widely used as slab-on-metal decking floor framing systems.

2.3 Structural Design

In order to build a structure in the United States, different types of codes must be followed: building codes and structural design codes specific to both the city and state. Typically, building codes for specific cities are found in Ordinances, which is true for the city of Worcester, Massachusetts. Building codes specific to the state are found in the form of state-specific amendments to the *International Building Code (IBC)*, which is true for Massachusetts. The governing building code for this project is the 8th Edition of the *Massachusetts Building Code*, which is comprised of the *2009 IBC* and amendments. The governing structural design code for this project is the standards of the American Society of Civil Engineers (ASCE) dealing with structural design and ethics. ASCE 7-05 contains structural requirements and is used by the project engineers to determine the structural capabilities of the building. The structural design amendments within the MA Building Code Amendments are derived from ASCE 7-05.

2.3.1 8th Edition of Massachusetts State Building Code

The ASEC must comply with Massachusetts Amendments to the *2009 International Building Code*. The project must comply with an addition to section 1604 (1604.11). Section

1604 deals with structural design values specific to each region. This addition is a table that contains various structural design values specific to the city of Worcester, MA, as seen in Table 1. The value p_g represents the ground snow load in psf, pounds per square foot. The value V represents wind speed in a three second gust specific to the region in miles per hour. The value S_s represents the mapped spectral acceleration for short periods in g (meters per second squared). The value S_1 represents the mapped spectral acceleration for a one second period in g, meters per second squared. A spectral response acceleration parameter relates to how violent an earthquake would be in that region for a given amount of time ("8th Edition 780 CMR Base Code MA Amendments to the IBC 2009," 2015).

Table 1 Structural Design Values for the City of Worcester, MA
 ("8th Edition 780 CMR Base Code MA Amendments to the IBC 2009," 2015)

City/Town	p_g	V	S_s	S_1
Worcester	55	100	0.24	0.067

The project must comply with an addition to section 1605.3.1 (1605.3.1 Equation 16-13).

Equation 1 Loading Combination Equation
 ("8th Edition 780 CMR Base Code MA Amendments to the IBC 2009," 2015)

$$\frac{2}{3}[1.2D + (1.6W \text{ or } 1.0E) + f_1L + 0.5(L_r \text{ or } S \text{ or } R) + 1.6H]$$

The above equation replaced the original in the IBC, where D represents dead load, L represents live load, L_r represents roof live load, S represents snow load, R represents rain load, all of which are gravity loads. W represents wind load, E represents earthquake load, H represents load due to lateral earth pressures, all of which are lateral loads. The second term in

the equation should be disregarded if a beam or girder is being analyzed. The value f_i is 1 for places of public assembly, such as parking garages where live loads exceed 100 pounds per square foot; it is 0.5 for other live loads ("8th Edition 780 CMR Base Code MA Amendments to the IBC 2009," 2015).

To implement an alternative floor framing system into the proposed alternate design, the manufacturing aspect of the alternate flooring system must comply with an added section to the IBC (780 CMR 110.R3). If any part of the proposed design contains manufactured parts, those parts and their installation must comply with Section 110.R.3. of the 8th Edition of MA Building Code Amendments.

The project must comply with Massachusetts amendments to the appendix of the IBC ("8th Edition 780 CMR Base Code MA Amendments to the IBC 2009," 2015), specifically those dealing with structural design. The new design had to comply with all ASCE codes dealing with structural design, specifically ASCE 7-05.

2.3.2 Design of Girder-Slab System

In order to design a Girder-Slab floor framing system, D-beams must be selected based on the dimensions of the building and the specified loading conditions. The design must follow ASCE design standards, specifically ASCE 7-05.

Loading Combination Calculations

In order to calculate the loading on a member, it must be determined which method of design will be utilized, either Load and Resistance Factor Design (LRFD) or Allowable Strength Design (ASD). This project follows the LRFD method. Given values needed to evaluate the loading combination equation values and determine the critical design loading are outlined in the table below:

Table 2 Units of Loading Combination Equation Values

Value	Unit
Length of member	feet
Weight of member	pounds per foot
Tributary width	feet
Loading condition(s)	pounds per square foot

If the member is a W-shape, the weight of the member is the second number in the name of the W-shape. For example, the weight (in lb/ft) of a W18X35 member is 35 lb/ft. The weight in pounds per foot of all other shapes can be found in the AISC Design Manual.

The tributary width is the half of the distance from each parallel support, as seen in Figure 3.

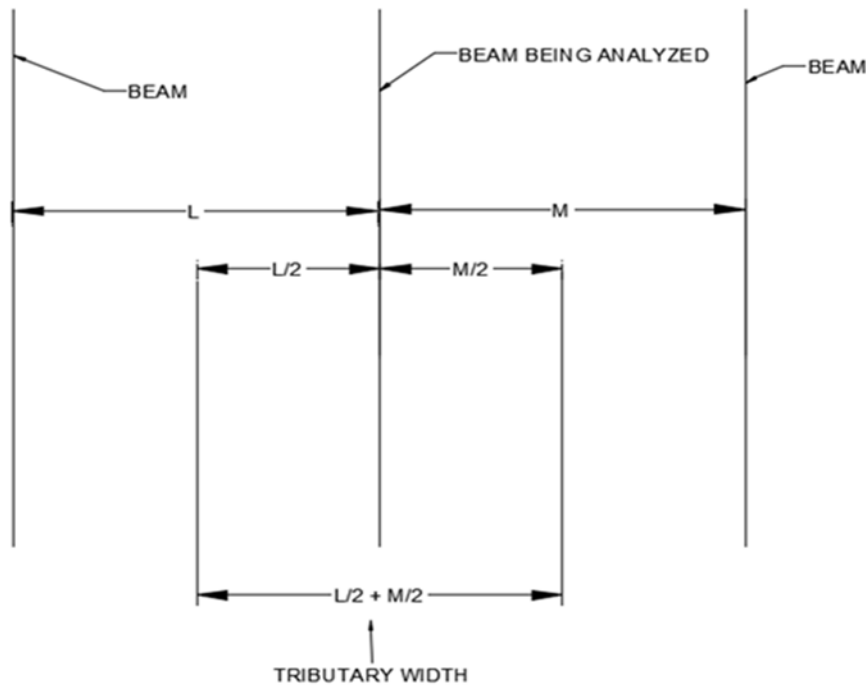

Figure 3 Tributary Width Definition Visual

Once the tributary width is obtained, the applicable loading conditions must be defined. Possible loading conditions are outlined in Equation 1 in Section 2.3.1. All loading combination equations can be found in Chapter 2 of ASCE 7-05. The equation used for this design's

calculations is Equation 2 in Section 2.3.2 of ASCE 7-05. In the third value in the equation, the largest value of roof live load, snow and rain load is used; the remaining are disregarded.

Equation 2 Loading Combination Equation

$$1.2(D + F + T) + 1.6(L + H) + 0.5(L_r \text{ or } S \text{ or } R)$$

Before substituting values into the equation, the loading conditions in pounds per square foot of floor area are multiplied by the tributary width. In the dead load calculation, after the first value "D" loading condition has been multiplied by the tributary width and the value is now in lb/ft, the weight of the beam is added onto that value. Then, that value is multiplied by the factor specified in the loading combination equation (1.2 in Equation 2). The live load and snow load both must be multiplied by the tributary width and factor specified in the loading combination equation to obtain a lb/ft value. As a result, the final loading combination value is in pounds per foot.

D-beam Selection

To select D-beams, the Girder-Slab Excel Design sheet (The Girder-Slab System LRF Design Version Design Guide) is used. The length, tributary width, slab thickness and loading conditions must be known. Those values are input into their respective cells and the design tool selects a D-beam. Based on the given information, the design tool performs the following checks.

Noncomposite/Composite moment

The noncomposite/composite moment is the moment due to the factored load (w_u) and the length of the member (L). The factored load is measured in pounds per inch and the length of the member is measured in inches.

Equation 3 Noncomposite/composite Moment

$$M_u = \frac{w_u L^2}{8} \text{ lb} \cdot \text{in}$$

The noncomposite/composite moment (M_u) must be less than the design moment capacity ($\Phi_b M_n$). The factor Φ_b , should be taken as 0.9. The design moment capacity is the yield strength multiplied by the plastic section modulus with respect to the x axis (Z_x).

Equation 4 Design Moment Capacity

$$\Phi_b M_n = \Phi_b f_y Z_x, \text{ lb} \cdot \text{in}$$

Horizontal Shear (Noncomposite)

The noncomposite vertical shear capacity is used to determine if the strength and spacing of the welds holding the flange and web together and the geometry of the D-beam will sufficiently support the given loading conditions. This is used to ensure that the D-beams will sufficiently support all construction loadings, before the concrete grout has cured. The vertical shear capacity (ΦV_n) is calculated using Equation 5, where $\Phi = 0.75$, ΦV_{horiz} is the the shear strength of the weld between the top bar and the web of the noncomposite D beam, in $\frac{\text{lb}}{\text{in}^2}$, I_x is the moment of inertia with respect to the x axis in inches⁴, Q is the centroid of the D-beam cross section, in inches and L is the spacing between the centerlines of adjacent welds along the span of the D-beam, in inches. This value must be at least as great as the average factored vertical shear, V_u . which is the demand shear strength created by the given loading conditions and length of the D-beam. The average factored vertical shear is calculated as shown below in Equation 6, where w_u the unfactored load in pounds per foot and L is the length of the D-beam, in feet.

Equation 5 Vertical Shear Capacity

$$\Phi V_n = \Phi V_{horiz} \frac{I_x}{QL}$$

Equation 6 Average Factored Vertical Shear

$$\Phi V_n \geq V_u = \frac{w_u L}{2}$$

Horizontal Shear (Composite)

The demand shear strength (V_u) must be less than the available shear strength of the full composite section ($\Phi_v V_n$). This is used to ensure that the D-beam will sufficiently support the given loading conditions after the concrete grout has cured. The demand shear strength is found by using Equation 6. The shear strength of the full composite section is provided by just the web of the D beam; it can be calculated by using Equation 7, where $\Phi_v = 1.00$ (as specified by the Girder-Slab design tool), f_{yw} is the yield strength of the web which is 50 ksi and A_w is the area of the web.

Equation 7 Shear Strength of Full Composite Section

$$\Phi_v V_n = 0.6 f_{yw} A_w$$

Floor live load deflection

The deflection of girders due to live loads must be less than the length of the beam or girder divided by 360, in inches. The deflection of a simply supported beam due to live loads is calculated in Equation 8, where w is the unfactored load, in pounds per foot, L is the length of the beam or girder, in inches, E is the modulus of elasticity, in psi, and I_x is the moment of inertia with respect to the x axis, in inches⁴.

Equation 8 Deflection Due to Live Load

$$\Delta_{LL} = \frac{5}{384} \left(\frac{wL^4}{EI_x} \right)$$

Flexural Ductility Check

The strain at the bottom of the flange ($\epsilon_{web/flange \text{ intersection}}$) must be at least twice the yield strain (ϵ_y) of the D-beam material. The yield strain of the D-beam material multiplied by two ($2\epsilon_y$) is assumed to be 0.003 at the extreme compression fiber of the cementitious material farthest away from the plastic neutral axis ("The Girder-Slab System LRFD Version Design Guide v3.2," 2015). The strain at the bottom of the flange ($\epsilon_{web/flange \text{ intersection}}$) is calculated

using Equation 9, where E is the modulus of elasticity, in psi, A is the area underneath the plastic neutral axis, in inches² and q_u is the factored load on the D-beam, in pounds.

Equation 9 Strain at the Bottom of the Flange

$$\varepsilon_{\text{web/flange intersection}} = \frac{q_u}{AE}$$

In order for a particular D-beam to be acceptable, it must pass the requirements for both composite and noncomposite moment and shear.

2.3.3 Design of Baseplates and Footing for Steel Columns Exposed to Weather.

The AESS columns were designed to support the canopy of the building using elegantly designed pinned connections that were attention grabbing and visually pleasing, since the connections themselves would be exposed for anyone to see. The study of the AESS columns consisted of changing the pinned base connections to fixed connections to investigate how the loadings would change on the column. In order to design the fixed connections on the columns, however, the steel baseplate and footing of each column needed to be redesigned to support the existing loadings as well as a moment that would be generated with the fixed connections. Due to the columns being external from the building, combined effects of vertical and lateral wind loads must also be considered in the design. The following procedures were used to design the new fixed connections for the AESS columns.

Wind Load Design Factors

The wind design loads are an important consideration when determining the loads acting on the AESS columns. Wind loads can be very complex, having both positive and negative lateral loads acting on a single object. Additionally, buildings can generate wind uplift and downlift depending the extent of the roof overhang. There are two methods used to analyze the

wind loads acting on a building, Method 1 is used if the height of the building is below 60 feet and Method 2 if the height of the building is above 60 feet. The following design procedure follows Method 1 for component and cladding due to the columns being outside of the building, having a total length under 60 feet and not being a part of the Main Wind-Force Resisting System (MWFRS). For details on the design process of Method 2, please refer to Chapter 6 of ASCE 7-05.

Using the simplified procedure outlined in Method 1, the net wind design pressure must be determined with equation 6-2 from ASCE 7-05.

Equation 10 Net Wind Design Pressure

$$P_{net} = \lambda * K_{zt} * I * P_{net30}$$

The net wind design pressure acting on the external columns of the building depends on the wind speed as well as many factors including adjustment, topographical and importance which vary depending on locations. The variables above can be found using the exposure category and mean height of the building applied to ASCE 7-05, Chapter 6.

Table 3 Net Wind Design Pressure Variable Table

Variable	Definition	ASCE 7-05 Section Described
λ	Adjustment Factor	Chapter 6, Figure 6-3
K_{zt}	Topographical Factor	Section 6.5.7
I	Importance Factor	Chapter 6, Table 6-1
P_{net30}	Net Wind Design Pressure for Exposure B at $h = 30$ feet	Chapter 6, Figure 6-3

The building has a wind exposure category B and utilizes a flat roof. Using this information, Figure 6-3 from ASCE 7-05 is used to determine net wind design pressure at a height of 30 feet applied to the different zones of the building. The positive and negative pressures taken from Figure 6-3 in ASCE 7-05 are then applied to the above equation to find the positive and negative design wind pressures acting laterally on the exposed columns.

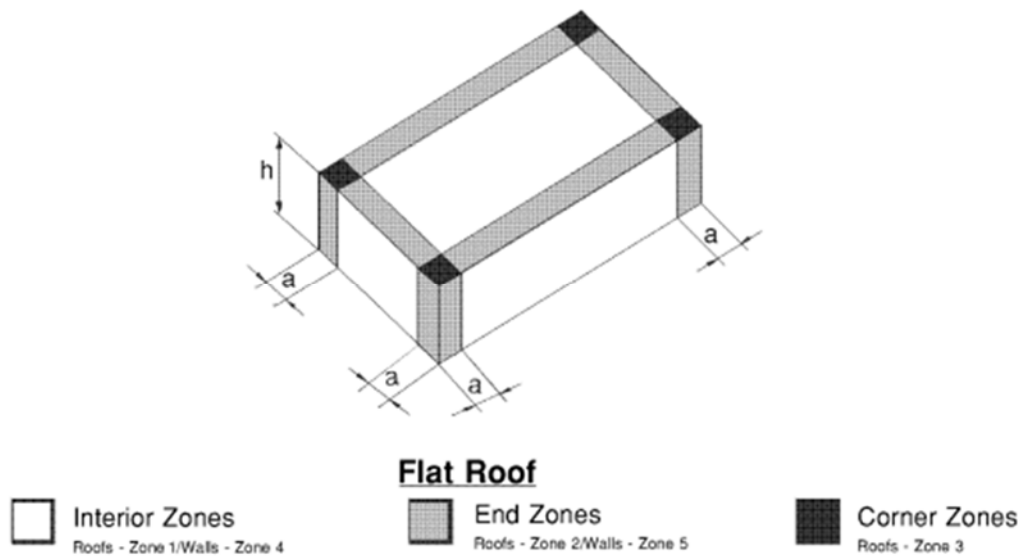

Figure 4 Wind Design Zones on a Flat Roofed Building

Steel Baseplate

The design process for a moment resisting steel baseplate is outlined below.

First, the following values must be known.

Table 4 Steel Baseplate Design Values

Notation	Description	Unit
SDL	dead load	psf
LL	live load	psf
c	column diameter	inches
column weight	Weight of column	lb/ft
L	Height of column	feet
Neg. Wind	negative wind load	psf
Pos. wind	positive wind load	psf
TW	tributary width	feet
TL	tributary length	feet
F _y	yield strength of plate	ksi
f' _c	yield strength of concrete	ksi

First, the factored axial load in kips (P_u) must be determined by Equation 11.

Equation 11 Factored Axial Load

$$P_u = \frac{1.2(\text{weight of column X height of column} + \text{SDL X TW X TL}) + 1.6 \text{ X LL X TW X TL}}{1000}$$

Next, the governing wind load value must be determined. It is taken as the larger of the absolute values of the positive and negative wind load values. Then, the lateral load due to wind can be found in pounds per foot (w_{wind}), using Equation 12. The wind load value is in psf and the diameter of the column is in inches.

Equation 12 Wind Load

$$w_{\text{wind}} = \text{wind load value X } \frac{\text{diameter of column}}{12 \text{ inches per foot}}$$

Then the resulting moment due to lateral loads must be determined in ft-kips (M_u), using Equation 13, where w_{wind} is in pounds per foot and L is height of the column in feet.

Equation 13 Moment due to Lateral Loads

$$M = \frac{w_{\text{wind}} L^2}{8}$$

Then the eccentricity (e) can be determined using Equation 14, where P_u is the factored axial load and M is the moment due to lateral loads. The eccentricity is the location of the resulting force from the axial force and bending moment, measured in inches from the left side of the plate.

Equation 14 Eccentricity

$$e = \frac{M \text{ X } 12 \text{ inches per foot}}{P_u}$$

The resulting stress in the baseplate due to the axial load (f) in ksi, dependent on the geometry of the plate, is determined next. It can be calculated in ksi using Equation 15, where P_u is the factored axial load in kips, e is the eccentricity in inches, c is the diameter of the column in inches and plate side lengths are measured in inches. It is taken as the larger of the absolute values of the positive and negative calculated values.

Equation 15 Stress in Baseplate due to Axial Load

$$f = -\frac{P_u}{\text{plate side length}^2} \pm \frac{P_u ec}{\frac{1}{12} \times \text{plate side length}^4}$$

Geometric properties must be defined for simplicity in calculations. The value a is the length from the edge of the baseplate to the column, in inches. Next the moment on the column (M_u) must be calculated. It can be calculated in in-kip by using Equation 16, where a is measured in inches, c is measured in inches and f is measured in ksi.

Equation 16 Moment on Column

$$M_u = \frac{a^2}{2} f(a + c) + \frac{2a^2}{3} f(2a + c)$$

Next, a geometric property n , measured in inches must be determined. It can be calculated using Equation 17, where c and the plate side length are both measured in inches.

Equation 17 Geometric Property

$$n = \frac{\text{plate side length} - 0.8c}{2}$$

The average resulting stress in the baseplate (f_p) in ksi, can be determined using Equation 18, where a is measured in inches, c is measured in inches and f is measured in ksi.

Equation 18 Average Resulting Stress in Baseplate

$$f_p = \frac{f(1 + \text{plate side length})}{2}$$

The geometric property n and average resulting stress in the baseplate can now be used to calculate the bending moment in the transverse direction in in-kip ($M_{u,trans}$), where f_p is measured in ksi and n is measured in inches.

Equation 19 Moment in Transverse Direction

$$M_{u,trans} = f_p \frac{n^2}{2}$$

In order for the baseplate to be considered sufficient to support the axial and lateral forces, the moment on the right side of the column (M_u) must be greater than the bending moment in the transverse direction ($M_{u,trans}$).

If that is the case, then the thickness of the plate (t) can be determined in inches using Equation 20, where M_u is measured in in-kip, $\Phi_b = 0.9$ and F_y is measured in ksi.

Equation 20 Thickness of Baseplate

$$t = \sqrt{\frac{6M_u}{\Phi_b F_y}}$$

The plate is selected by side length dimensions and thickness, both in inches, from the AISC Manual.

2.3.4 Footing Design

To select the pier and footing dimensions for the AESS columns, knowledge from CE 3008 (Design of Reinforced Concrete) is used, as well as methods outlined in ACI 318-14 (American Concrete Institute, 2014). The foundation type is determined using Fig R13.1.1 in ACI 318-14 and material properties of the concrete is determined in chapter 19 of ACI 318; the concrete for this project has a 28-day compressive strength of 4000 psi. The total loads acting on the column are taken and applied to equations in ACI 318-14 to determine the required area of the footing.

Equation 21 Required Footing Area

$$\frac{\text{total service load } (\Sigma P)}{\text{Allowable Soil Pressure}(q_a)} \text{ in } in^2$$

The equation is applied for dead loads, dead plus live loads and dead plus live plus earthquake loads and the largest required area governs the dimensions of the footing. The soil pressure is determined with geographical knowledge of the area applied to equations in ACI 318-14 and

used to determine the footing area. The soil pressure is calculated using three separate load cases and the highest value governs. With the soil pressure, the effective depth of the footing can be calculated as well as rebar configuration. Since the new connection column connections will be fixed, the footing needs to be able to withstand the added moment. To do so, the resultant eccentric force from the vertical force and moment should lie within the middle third of the footing base length. The figure below illustrates the changes made on the loadings to have the load lie within the middle third of the footing base length.

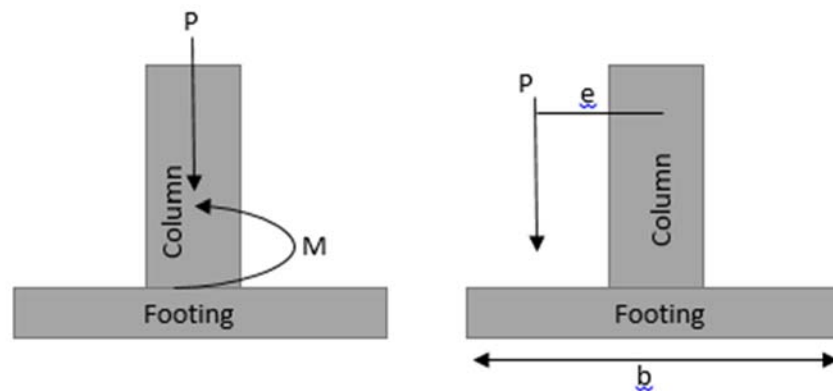

Figure 5 Footing Base Design

The loading, P , is moved in order to account for the moment, M , that is created from the fixed column. The distance, e , can be found using the following equation.

Equation 22 Moment using Load and $\frac{1}{3}$ footing Base Length

$$\text{Moment: } M = P * e$$

Finally, the base dimensions of the footing can be calculated using the found value of, e . The base dimension, b , is approximately equal to $6 * e$. When the dimensions of the footing are calculated, it's important to check that the maximum soil pressure, q_{max} , does not exceed the allowable soil pressure, q_u . The maximum soil pressure can be calculated using the following equation.

Equation 23 Max Soil Pressure Check

$$\text{Max Soil pressure: } q_{max} = -\frac{P}{A} \pm \frac{M * c}{I}$$

2.4 Project Management

This section will discuss four major aspects associated with project management: cost estimating, project scheduling/control, project communication, and lean construction.

2.4.1 Construction Cost Estimating

Cost estimating is used to predict the cost of a project. Construction management firms provide pre-construction services that include cost estimating during the design process. This service allows contractors to bid or provide a cost estimate on construction projects in their scope of work. The more accurate the cost estimate, the more likely the construction company will stay on budget and make a profit, which in turn satisfies the owner. Inaccuracies within the cost estimate can cause projects to go over budget and companies to lose money on projects. Going over budget can cause a company to go out of business (Halpin, 2010).

Types of Cost Estimates

There are four main types of cost estimates used during the design and construction process of a building. They are conceptual estimate, preliminary estimate, engineer's estimate, and bid estimate (Halpin, 2010). The conceptual estimate and preliminary estimate take place during the design phase and are both reviewed by the owner. This allows the owner to review the project progress and provide input to the project before making the final budget. Once the final design of the project is completed, the engineer drafts an engineer's estimate with the projected project cost and estimated unit quantities for all of the bid items. This estimate is used to compare the bidding price for all construction firms bidding the project. The bid estimate is produced by the construction firm bidding on the project, and often but not always, includes a

unit price for each item in the bid list. Various factors associated with the cost of materials, labor, equipment, and man hours are incorporated into the unit price. This estimate also includes a markup, which is additional money allocated for overhead, non-project related costs associated with running a business, and the money the construction company expects to make on the job, known as profit (Halpin, 2010).

Cost Estimating Methods

The most common way of generating these preliminary cost values is through a unit cost estimate. A unit cost estimate is generated by multiplying the unit quantity of an item with an estimated price per unit of the item. Most contractors have their own unit cost databases that they rely on for generating estimates. For this project, the source for unit pricing values is the R.S. Means Company’s *Building Construction Cost Data* (Halpin, 2010).

2.4.2 Construction Scheduling

Project management encompasses a wide variety of tasks including scheduling, organizing, controlling, and coordinating. Each of these functions play a large role in the project management process, and these tasks are usually carried out by a project manager. Table 5 below shows each of these functions and why they are important to the project process ("Planning, Scheduling and Construction Management," 2014).

Table 5 Functions of Project Management ("Planning, Scheduling and Construction Management," 2014)

Function	Importance
Planning	Determines what needs to be accomplished and how it will be accomplished.
Scheduling	Outlines project duration and establishes task completion dates.
Organizing	Compiles project tasks and assigns them to their respective departments.
Controlling	Tracks project progress and makes adjustments to stay on track.
Coordinating	Forms collaboration between all involved departments to ensure synergy.

Importance of Scheduling

The objective of scheduling is to execute the project plan while sticking to a time-line. Project scheduling shows the duration and order of various tasks to be carried out. In creating this schedule, the projected start and finish dates for the overall project are determined. There are many advantages to creating a schedule such as determining the best method of executing the project. It allows for the quantity of workers, material and equipment to be determined at different stages of the process. Additionally, scheduling enables progress to be tracked which determines if the project is staying on target. A Gantt chart or network diagram creates a visual representation of the project time-frame to facilitate coordination among all parties involved on the project. This shows the durations and precedence logic for project tasks. Weather is very unpredictable and is therefore addressed after the fact. An important part of the schedule is the critical path. This is the connection of tasks that make up the longest pathway in the schedule and determines the initial start and end dates of the project. The critical path is very significant because any delay to the tasks along the critical path will result in a delay to the overall project schedule (Sheba, 2015).

2.4.3 Project Communication

Communication plays a large role in the success of a construction project. It is the construction manager's responsibility to coordinate communication among all parties involved in the construction process, mainly the owner, architect, and subcontractors. A breakdown in communication among these various parties often leads to problems during the construction process. A process often used to minimize these problems and encourage communication is owner's meetings.

Owner's Meetings

Owner's meetings, also commonly referred to as Owner/Architect/Contractor (OAC) meetings, usually occur on-site on a weekly basis as a source of project communication. These meetings allow the owner/owner's representative, architect, and construction manager (CM) to discuss the project progress. The agenda is created by the CM, who also runs the meeting. The following table summarizes topics most commonly addressed during these meetings (Radosavljevic, Bennett, & Ebrary Academic, 2012).

Table 6 Common Topics of Discussion at OAC Meetings (Radosavljevic et al., 2012)

Common Topics of Discussion
Submittal, RFI, and Change Order Status
Payment Requisition Status
Budget
Schedule
Resolve Drawing Discrepancies
Safety Report

The CM follows a similar format to Table 6 during their owner's meetings. Discussing all of these topics while the owner, architect, and CM are all in same room allows for efficient conflict resolution and decision making (Radosavljevic, et al., 2012). When there is a lack of information in the drawings or specifications, the CM will submit a Request For Information (RFI) to the designer, usually the architect or engineer, for clarification. The CM's goal is to identify and clarify the missing information as quickly as possible to prevent any delays and added costs to the project. However, a quick response to the RFI is not always possible or does not always happen because the engineer or the architect may need more time when responding.

2.4.4 Lean Construction

Lean construction is a process used to reduce “cost, materials, time and effort:” (Mackie, 2014). Lean construction originated from the idea of lean production, which was developed by Toyota led by Engineer, Taiichi Ohno. The idea of lean production was developed to eliminate waste in mass production and create more efficiency in the production line.

In the construction management field, the goal of lean construction is to maintain maximum production while having minimal waste and time delay. Lean construction entails implementing management practices to increase construction efficiency; these practices include increasing communication among all involved, increasing worker accountability, and increasing schedule reliability. Project managers now use lean construction techniques to efficiently plan and control construction sites. Using lean construction helps prevent future problems by identifying possible communication issues (Mackie, 2014).

Lean methods increase schedule reliability, predictability, and productivity as a result of a higher rate of planning, increased profits and turnovers, customer satisfaction, worker accountability and job satisfaction. Incorporating BIM with lean practices is very common in the preconstruction stages of the building to prevent any MEP conflicts and lack of material storage space. Lean construction also improves the overall project results due to improved communication (Mackie, 2014).

Consigli Construction uses lean construction methods throughout all of their projects. “Lean efforts focus on identifying opportunities to reduce inefficient use of resources, and to create more value through our work. It is about encouraging continuous improvement on a daily basis while maintaining respect for people,” (Consigli Construction, 2015). Specifically for the ASEC project, Consigli uses a variety of Lean construction practices on and off of the job site. For efficiency, Consigli encourages their subcontractors to shop build as much as possible before

bringing items to the site. To prevent large amounts of stockpiled material on the site, Consigli brings in portions of a material delivery instead of the whole delivery at one time. Consigli manages deliveries so that no more than one week's worth of material is brought into the building at one time to prevent turning the building into a warehouse. All materials being stored in the building are kept on wheels so that they can be easily moved out of the way (Condon, 2016).

2.4.5 Software Tools Used

This section will discuss the various software tools that were used to complete this project such as *On-Screen Takeoff 3*, *Autodesk Revit 2016*, *Microsoft Project*, and *Autodesk Navisworks*. Each software is presented as a summary of its main functions and how it was used. Building Information Modeling, BIM, is also be discussed.

Building Information Modeling (BIM)

Building Information Modeling is “a digital representation of physical and functional characteristics of a facility. As such it serves as a shared knowledge resource for information about a facility forming a reliable basis for decisions during its lifecycle from inception onward.” (National Institute of Building Sciences, 2007). Many of these technologies are software tools such as *Autodesk Revit 2016*, *Microsoft Project*, and *Navisworks*, which are used to develop a 5D model of a building. With the increasing pressure of bid competition, production deadlines and continually increasing quality expectations, BIM is a common approach in the construction industry (Popov, Juocevicius, Migilinskas, Ustinovichius, & Mikalauskas, 2010). Some identify BIM as dealing with only 3D modeling and visualization. Using the process of BIM, one would have the capability of creating a three dimensional (3D), four dimensional (4D), and/or five dimensional (5D) representation of a future structure. A 4D model is a visual representation of

the planned building incorporating the construction schedule. Integrating construction cost data into the 4D model creates a 5D model.

BIM software packages cover virtually all phases of the construction process such as the planning, design, cost estimating, scheduling, construction, fabrication, maintenance and facility management. According to the National Institute of Building Sciences, BIM's primary goal is to "eliminate re-gathering or reformatting of facility information," (Smith & Edgar, 2008). BIM's most important objective is to improve business function so that both the owner and the project management firm benefit from a faster and more cost effective completion date. BIM is used in this project to produce a 5D visual representation of both the current building and the new design.

On-Screen Takeoff 3

On-Screen Takeoff 3 is a construction software that allows the user to view the construction drawings in pdf format, complete quantity takeoffs, perform estimations, and execute project management tasks. Plan viewing of construction drawings and quantity takeoffs were the two features most commonly used for this project. The plan viewing tools and quantity takeoffs allow the user to measure unmarked lengths, angles, areas, and volumes. For example, using the correct dimensions specified on the plans, the measuring tool can be used to obtain correct linear dimensions. To use the measuring tool, click on the first spot where the measurement starts and then drag the cursor to the spot where the measurement ends. The software allows the user to download and view in multiple windows the constructions drawings being used (On Center Software, 2015).

Autodesk Revit 2016

Autodesk Revit 2016, also known as *Revit*, is a software for structural engineers, architects, designers and MEP engineers that is used to create 3D models using BIM. This

software allows users to create 2D views, such as a floor plan, and to create and design 3D buildings, structures, and components. *Revit* users can create a 4D model by using tools to plan and track various stages in a building's lifecycle. *Revit* has architectural plan templates, structural plan templates, and MEP plan templates for the user to create a building. *Revit* allows the user to implement pre-made component families as well as loadable families which can be made from scratch to construct the desired design. Families can range from furniture and light fixtures components to columns and beam components. *Revit* also allows the user to create renderings of their design to show a more realistic representation of the 3D model. *Revit* also allows the user to create walkthroughs and fly-around animations (Revit, 2015).

Microsoft Project

Microsoft Project is a software package that allows project managers to analyze budgets, timelines and resources. Using *Microsoft Project*, project managers can also measure the construction progress and anticipate project needs through monitoring the schedule. Project executives are able to measure strategic impacts and view project status. *Microsoft Project* improves collaboration between contractors and subcontractors because it notifies both parties when another party has made a change to the schedule (Project, 2015). CM's have access to the scheduling software to make any changes to the schedule which are then sent to the other parties. This program also allows the user to sync the schedule and cost estimate together so that the user can develop a 5D model in *Navisworks* combined with the 3D *Revit* Model.

Autodesk Navisworks

Navisworks is software package that enables the architect, project manager, and owner to visualize the project schedule and cost through animation. *Navisworks* allows the user to import *Revit* files and *Microsoft Project* files to develop 5D models. *Navisworks* allows the user to create a video of the building that shows the phases of the construction and the cost of each

phase throughout the project (Navisworks, 2015). With the combination of these building information modeling softwares, a 5D model is created.

Now that the key background elements for the work have been explained, the next six chapters explain the methodology and results. Chapters 3 and 4 focus on the structural aspects of the alternative design. Chapters 5 and 6 explain the cost estimating and scheduling processes and outcomes for the current and Girder-Slab design. Chapter 7 is about the methodology used to generate the 5D models for the current and alternative design. Chapter 8 is about the methodology and results used to carry out an RFI analysis.

3 Design of an Alternative Floor Framing System

One objective of this project was to design a Girder-Slab floor framing system to replace the current slab-on-metal decking floor framing system. Using the original structural drawings, D-beams were selected using a design tool provided by the Girder-Slab website. Angle sections were added onto W shapes that were being kept in certain area of the floor framing systems to keep the precast concrete planks in place. All calculations done for this design followed the design processes outlined in the background section.

3.1 Loading Combination Calculation Process

In order to design a new floor framing system, existing dimensions from the original floor framing system were established. Before dimensions could be recorded, all beams and girders were assigned a number by floor. From the original drawings with labeled beams and girders members, the lengths and tributary widths for all beams and girders were recorded. Some dimensions could be determined from the plans alone but ones that could not were determined using *On-Screen Takeoff 3*. Lengths and tributary widths were recorded on an Excel sheet, as seen in Appendix A. Loading combination results were obtained by the process outlined in the section “Loading Combination Calculations” of the background.

The different types of loads considered for the beams and girders were determined from the structural plans. There are several beams and girders that are under two types of live loads. For example, there are multiple cases where one part of a beam or girder has two different values for a live load because of the varying uses for the building, visually represented in Figure 6.

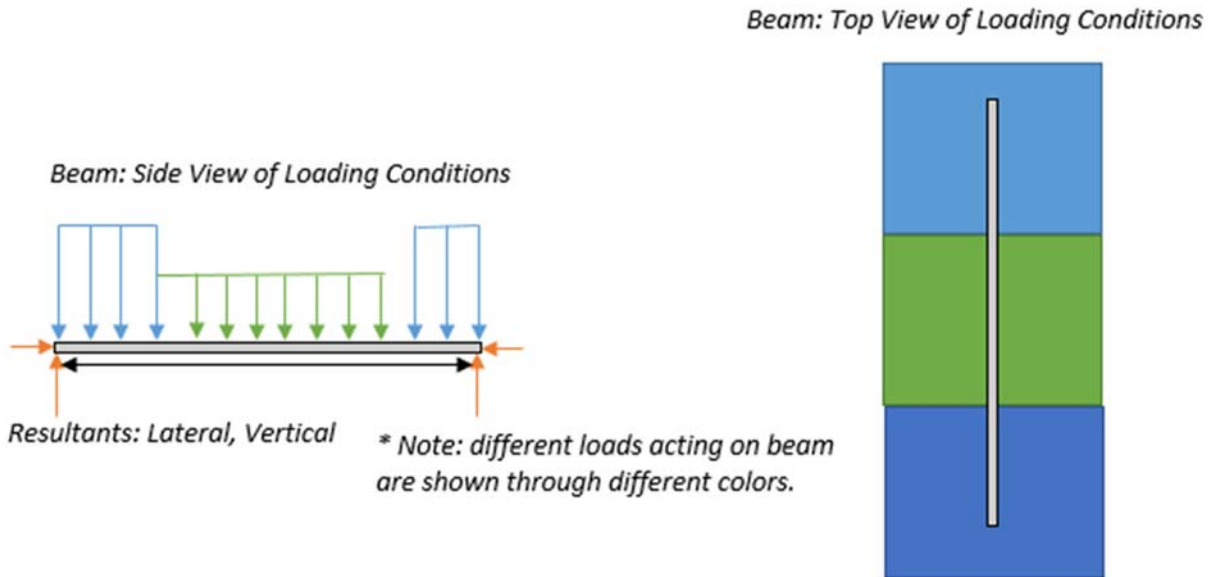

Figure 6 Visualization of Different Loadings Acting on a Beam

A sample heading of the loading combination Excel sheet can be seen in Figure 7.

On levels two and four, the beam or girder would have a separate row on the Excel sheet for each different loading condition; the length and tributary width are for only one loading condition. Beams or girders with two or more loading conditions have a box around the member size. On level three, beams or girders under multiple loading conditions had multiple columns for each loading condition. Next to the first “Loading Combination” column is a column labeled “Subtracted/Added”. If the cell is filled red, then the tributary area and loading on the right was subtracted from the value in the first “Loading Combination” cell. This indicates that the loading specified in the first column occupies a greater amount of space within the tributary area of the beam or girder. If the cell is filled green, then the tributary area and loading on the right was

Member	Weight (lbs)	Length (ft)	Tributary Width (ft)	Snow (psf)	Live Load (psf)	SDL (psf)	CDL (psf)	Beam Weight (lbs)	Load Combination (lbs/ft)
--------	--------------	-------------	----------------------	------------	-----------------	-----------	-----------	-------------------	---------------------------

Figure 7 Loading Combination Excel Sheet Heading

added instead. The loading value used for design is the one in the first “Loading Combination” column; this value has additional loadings subtracted or added to the original.

Loading conditions were specified under the columns labeled “SDL”, “CDL”, “LL” and “SNOW” in pounds per square foot. “SDL” stands for superimposed dead load, meaning the weight of the structural, architectural & MEP components. “CDL” stands for cladding dead load, meaning the weight of all components attached to exterior or partition walls. “LL” stands for live load, meaning the expected weight of occupancy. “SNOW” means the expected loading of the snow. This is only measured on exposed parts of the structure, i.e. on the roof. All possible loading condition values taken from the structural drawings are outlined in the table below:

Table 7 Types of Loads

Loading Condition	Specified Values (in psf)
SDL	20
CDL	20, 40
LL	100, 85
SNOW	40

3.2 D-Beam Selection

Once dimensions and loading conditions on all original beams and girders were recorded, D-beams were selected. D-beams were only selected to replace girders (beams running east to west). A design spreadsheet was obtained from the Girder-Slab website (Fisher, 2015) that selects D-beams based on loading conditions, length and tributary width, as seen in Figure 8. First, the D-beam selection was set to the lightest one, 8X37. The slab thickness was set to the minimum possible value in the design spreadsheet, 8 inches, to minimize the loading on the structure and the overall cost. Then, the D-beam span (length) and tributary width of load of the original beam were entered into their respective cells. The additional composite dead load (SDL), partition live load (CDL) and basic live load (LL) were also entered into their respective

cells. If a girder was subject to multiple types of loads and values, the largest magnitude was input for each type of load. Floor live load reduction was considered for all girders. The unit weight of grout was kept at 140 pounds per cubic feet for all girders. D-beam camber was kept at 0 inches for all girders. Once all values were correctly entered, the test was run. The D-beam was sufficient if all checks on the right side of the spreadsheet were labeled “OK” in blue. In order to determine if the D-beam could sufficiently support the specified loading conditions with the specified length and tributary width, the design checks outlined in section 2.3.2 on D-beam selections of the Chapter 2 Background had to be satisfied. The Girder-Slab spreadsheet automatically completes the necessary strength and deflection checks.

THIS SPACE HAS BEEN INTENTIONALLY LEFT BLANK

D-Beam® Calculator Reference Tool Version 3.2
(Load & Resistance Factor Design - AISC 14th Edition)

LRFD (14th Ed)

Project Name / Job #

D-Beam®
 D-Beam® = DB 6x61
 Parent Beam Yield Stress (F_y) = 50 ksi
 Top Bar Yield Stress (F_y) = 50 ksi

Span Information
 D-Beam® Span = 25 ft
 Composite Section Effective Width = 6.25 ft
 Total Tributary Width for Load = 23 ft

Precast Slab
 Nominal Slab Thickness = 8 in.
 Precast Slab Weight = 55 psf

Grout
 Unit Weight of Grout = 140 lb/ft³

Unfactored Loads
 Basic Dead Load (D-Beam® + Slab + Grout) = 59.0 psf
 Add'l Composite Dead Load (e.g. topping) = 0 psf
 Partition Live Load = 15 psf
 Basic Floor Live Load = 40 psf
 Consider Floor Live Load Reduction (IBC 2009/2012) = Yes
 Floor Live Load Reduction = 34.3%
 Reduced Floor Live Load = 26.0 psf

Factored Moments
 Basic Dead Load Moment = 180.54 154.75 kip-ft
 Add'l Composite Dead Load Moment = 0.00 0.00 kip-ft
 Partition Live Load Moment = 0.00 52.50 kip-ft
 Floor Live Load Moment = 0.00 91.12 kip-ft
 Total Factored Moment = 180.54 298.37 kip-ft

Factored Shears
 Basic Dead Load Shear = 28.89 24.76 kips
 Add'l Composite Dead Load Shear = 0.00 0.00 kips
 Partition Live Load Shear = 0.00 8.40 kips
 Floor Live Load Shear = 0.00 14.58 kips
 Total Factored Shear = 28.89 47.74 kips

Deflections (negative values indicate downward deflection)
 (optional) D-Beam® Camber = 2.50 in
 Basic Dead Load Deflection = -2.67 in
 Total Basic Dead Load Deflection including Camber = -0.17 in
 Add'l Composite Dead Load Deflection = 0.00 in
 Partition Live Load Deflection = -0.31 in

Design Checks - Noncomposite

Noncomposite Moment	M _u = 180.5 kip-ft	OK
	φ _t M _n = 190.3 kip-ft	
Horizontal Shear	V _u = 28.9 kips	OK
	φ _v V _n = 33.5 kips	

Design Checks - Full Composite

Floor LL Deflection Allow. Δ _{LL} = L ⁴ /360	Δ _{LL} = -0.53 in	OK
	L ⁴ /360 = -0.83 in	
Full Composite Moment	M _u = 298.4 kip-ft	OK
	φ _t M _n = 299.7 kip-ft	
Flexural Ductility Check	ε _{subflange intersection} = 0.009638	OK
	2s _y = 0.003448	
Shear	V _u = 47.7 kips	OK
	φ _v V _n = 75.9 kips	

CROSS SECTION ANALYSIS IS VALID → RUN

Section Properties **

Figure 8 Girder-Slab Design Tool Screenshot

3.3 D-Beam Selection Outcomes & Analysis

The final Girder-Slab floor framing system D-beam configuration for the second, third and fourth floor can be seen below in Figures 9, 10 & 11 respectively. Highlighted members are members that are being kept as either D-beams or W shapes. All others are omitted.

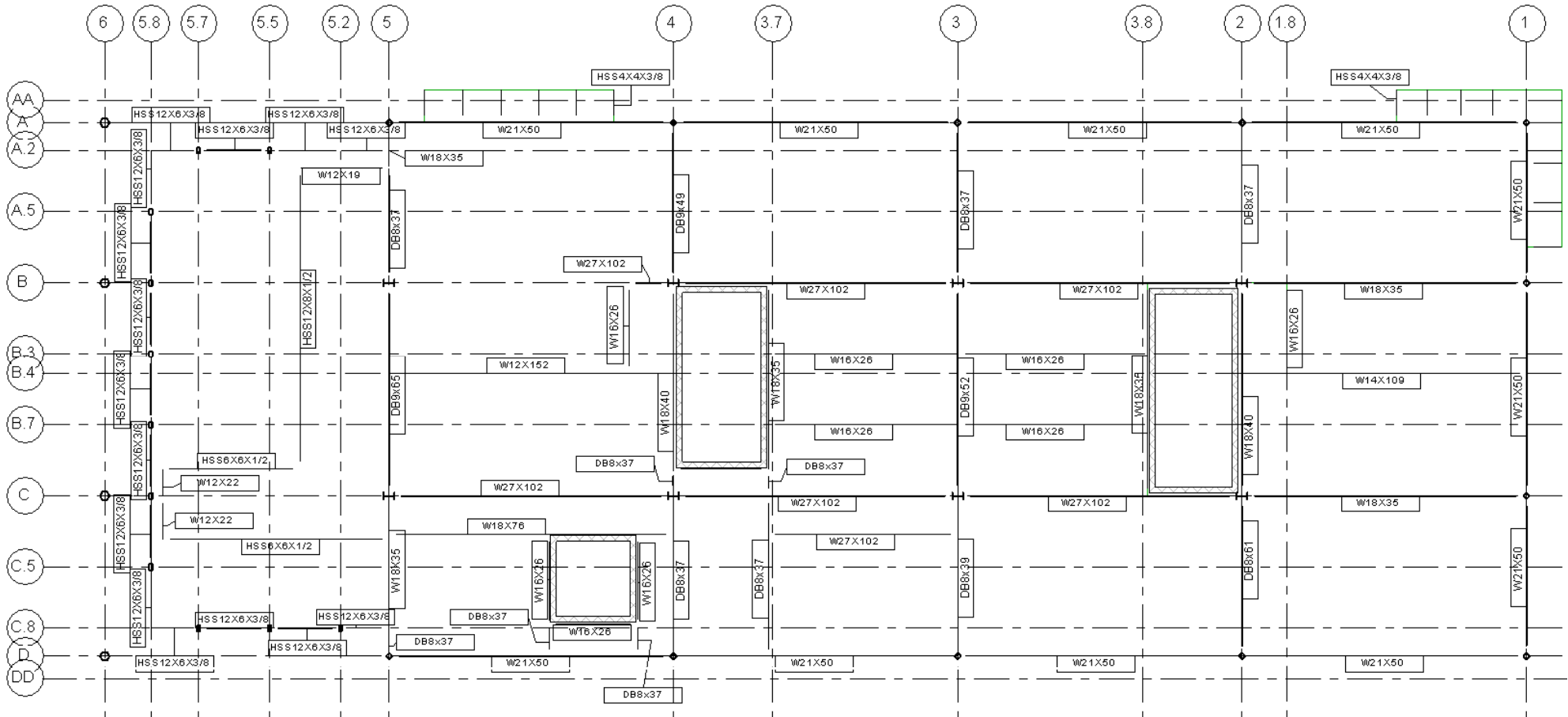

Figure 9 Second Floor Girder-Slab Floor Framing System Configuration

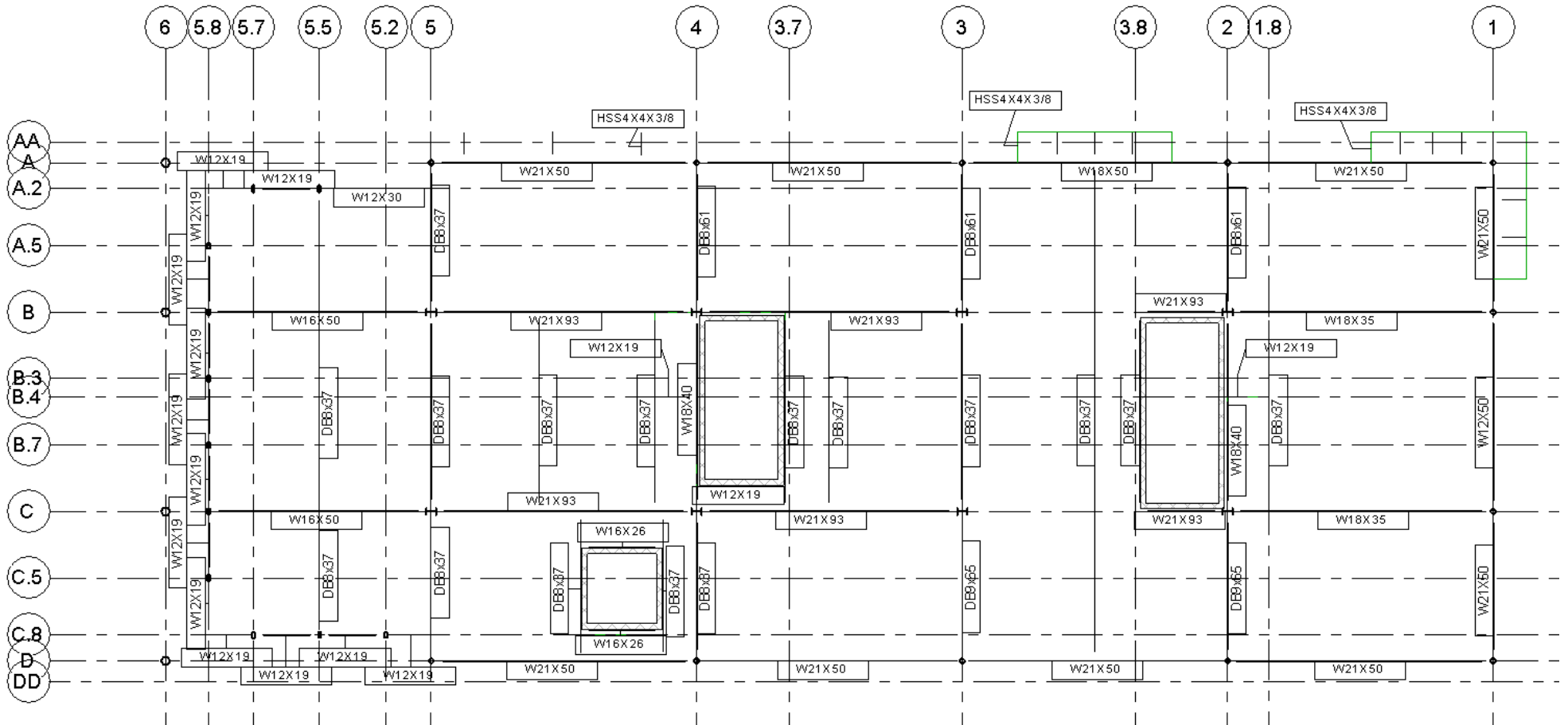

Figure 10 Third Floor Girder-Slab Floor Framing System Configuration

All exterior dimensions of the building remain the same, the only change is the configuration and type of beams and girders within the building's footprint. Final quantities of D-beams on the second, third and fourth floor can be found in Table 8 below and in Appendix B:

Table 8 D-Beam Size & Quantities

D-beam size	Quantity
8X37	37
8X39	2
8X61	5
9X45	1
9X46	1
9X49	1
9X52	2
9X65	6

The total number of beams and girder in the new Girder-Slab floor framing system is significantly less than the number of beams and girders in the original, yet the structural capabilities remain the same. Although this project contained a very varied loading plan, the Girder-Slab floor framing system was still able to be implemented.

The most challenging aspect of this new design was configuring the beams and D-beams to incorporate precast concrete planks. Simply replacing all girders in the original design would not have allowed precast planks to be properly installed. As a result, the design thought process not only contained structural considerations in terms of the D-beams but also constructability considerations in terms of installing the precast planks. The precast concrete planks had to be visualized first, following with D-beam placement.

3.4 W-Shape Selection Process

It was not possible to use D-beams exclusively to support the precast concrete planks. The precast planks could not be supported along the border of the structure by D-beams. In order to incorporate the new design, W-shapes had to be added in on the second and fourth floor. An Excel workbook (found in Appendix C) was created to select appropriate W-shape sizes. In order to select a W-shape, the following process must be followed.

W-Shape Selection

First, the design load (w_u) must be calculated. The length, tributary width, SDL value and LL value of the supported beam are needed. Then, w_u is found by Equation 24.

Equation 24 Loading Combinations Equation for DL, LL, & Snow (in lb/ft)

$$\begin{aligned} &1.2D + 1.6L + 0.5S \\ &= 1.2 \times [(\text{SDL} + \text{Weight of Concrete}) \times \text{Tributary Width}] \\ &+ (1.6 \times \text{LL} \times \text{Tributary Width}) + (0.5 \times \text{SNOW}) \end{aligned}$$

Equation 3 was used to find the design moment, which is the bending moment in the W shape due to the force from the D-beam and precast plank.

The design moment is then used to find the plastic section modulus limit (Z_x), meaning that the plastic section modulus of the selected W shape must not exceed the limit. In this case, M_u is the design moment found in Equation 25, $\Phi = 0.9$ and $f_y = 36\text{ksi}$.

Equation 25 Plastic Section Modulus Limit

$$Z_x = \frac{M_u}{\Phi f_y}$$

With the calculated Z_x value, the AISC shapes database (Construction, 2011) is used to find a W-shape. The W-shape with the Z_x value greater than or equal to the calculated value is selected.

The Excel workbook contains three sheets: “2ND FLOOR”, “4TH FLOOR” and “W-Shape Selection Tool”. The first two sheets are final results of the inputs from the “W-Shape

Selection Tool”. The “W-Shape Selection Tool” contains the beam reference number corresponding to the labeled plans. The “Length” column represents the length of the member in feet, the “TW” column represents the tributary width of the member in feet, “SDL” represents the dead load in psf and “LL” represents the live load in psf. The loading combination equation column represents the factored load in lb/ft, the “Mu” column represents the design moment in lb-ft, the “Z_x” column represents the calculated plastic section modulus in inches cubed. The “Z_x BOOK” column represents the plastic section modulus value of the selected W-shape, in inches cubed. The “SELECT” column is the selected W-shape. All results were manually input into tables in their respective sheets.

3.5 W-Shape Selection Outcomes & Analysis

The final Girder-Slab floor framing system configuration, including new W-shapes can be found in Figures 9, 10 & 11. The new W-shapes that were selected are listed in Table 9.

Table 9 W-Shape Selection Results

	Beam #	New W Shape
2 N D F L O O R	29	W12X152
	49	W14X109
	73	W18X76
A		W12X16
4T H F L O O R	A	W6X20
	B	W8X35
	C	W21X73
	D	W16X77
	H	W12X190

The W-shapes named with a letter refer to additional members that were needed to incorporate precast concrete planks into the design. They were added to ensure that concrete planks could be installed in rectangular sections. If concrete planks could have been installed in any shape, then all of the W shape entries in Table 9 would have not been necessary to add.

The W-shapes named with a number represent an instance where an existing member was extended to incorporate rectangular or square planks. The selected W-shape indicated in the table above represents the W-shape for the entire length, including the existing member. For the length of the existing member, this member is most likely oversized. However, the member must be designed for the new length.

The decision to include in W-shapes was not based on structural capacities. It was purely based on the geometry of concrete planks.

3.6 Angle Section Selection Process

Girders along the perimeter of the building were not replaced with D-beams. Instead, these girders were kept as the original W-shapes, and angle sections (sometimes known as L shapes) were welded onto the web of the original W-shape. These angle sections serve as a shelf to support the D-beams and precast concrete planks. See Figure 12 for more details on the configuration of the angle section design

THIS SPACE HAS BEEN INTENTIONALLY LEFT BLANK

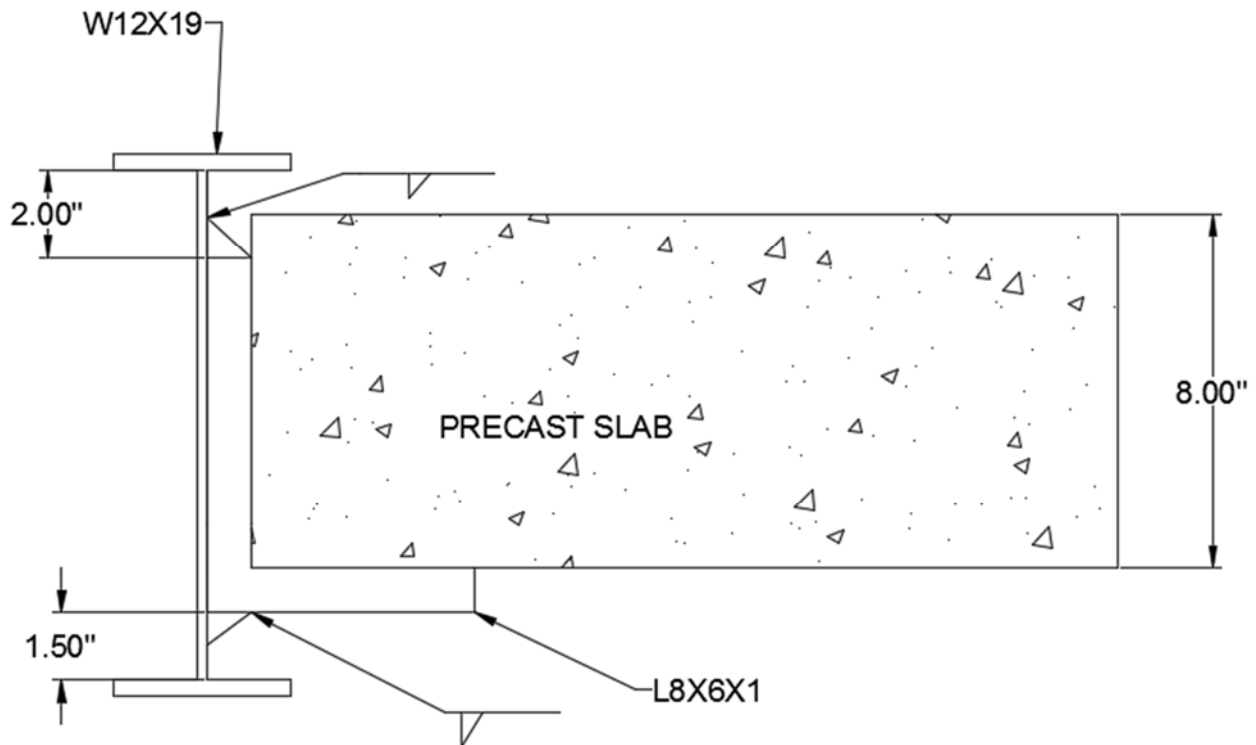

Figure 12 Exterior Beam Design with Angle Sections

Angle sections were picked based on loading conditions, length and tributary widths of their supported beams.

Angle Section Selection

First, the design load (w_u) must be calculated. The length, tributary width, SDL value and LL value of the supported beam are needed. Then, w_u is found by Equation 26.

The weight of the D-beams is found by counting the number of D-beams supported by the angle section and adding up their weights. For example if there were 4 DB8X37 D-beams supported by one angle section, then the weight of the D-beams would be $4 \times (37 \text{ pounds per foot}) = 148 \text{ pounds per foot}$.

Equation 26 Loading Combinations Equation for DL, LL, & Snow (in lb/ft)

$$\begin{aligned} 1.2D + 1.6L + 0.5S \\ = 1.2 \times [(SDL + \text{Weight of Concrete}) \times \text{Tributary Width}] + \text{Weight of D} \\ - \text{beams} + (1.6 \times LL \times \text{Tributary Width}) + (0.5 \times \text{SNOW}) \end{aligned}$$

Equation 27 was used to find the design moment, which is the bending moment in the angle leg due to the force from the D-beam and precast plank.

Equation 27 Design Moment

$$M_u = \frac{w_u L^2}{2}$$

The design moment is then used to find the plastic section modulus limit (Z_x), meaning the selected angle section with the Z_x value greater than or equal to the calculated value is selected, found by using Equation 25 in section 3.4.

With the calculated Z_x value, Table 2 in Elastic and Plastic Section Moduli of Steel Angles About Principal Axes was used to find an angle section (Ding, 2004). The angle section with the closest Z_w value to that would not exceed the calculated Z_x was selected and recorded. Sample hand calculations for angle section selection can be found in Appendix D.

An Excel workbook was created to select angle sections based on the process outlined above, as found in Appendix E. In the first column, the beam or girder number is recorded. In the next column, the section is indicated. If there is only one letter, then the angle section will be the length specified in the length column. If there is more than one letter, then the load could not be supported by a single angle section. This means that the calculated plastic section modulus exceeded all of the plastic section moduli found. In that case, the length was split into two equal parts and the angle sections were reanalyzed using the new lengths. The number of sections correspond to the number of pieces that the original desired length was split into. The sections

run west to east or south to north, meaning section A would be the furthest angle section on the west/north side followed by section B, etc. Corresponding values were inputted into the “Length”, tributary width (“TW”), dead load (“D”), live load (“L”) and weight of concrete (“conc”). The columns labeled “d beam wt” is how much of a D-beam in lb/ft the angle section is supporting. It is calculated by adding up all of the weights of the D-beams supported by the angle section within the tributary width. The next column represents the factored load in lb/ft. The following two columns represent the design moment and plastic section modulus, respectively. The next two columns contain geometric properties used to determine a Z_x value. Once the calculated Z_x value was found, the Z_w value found from Table 2 in Elastic and Plastic Section Moduli of Steel Angles About Principal Axes was recorded in the “Select” column (Ding, 2004). All final selections were copied onto separate sheets within the same workbook, specified by floor.

3.7 Angle Section Selection Outcomes & Analysis

The final Girder-Slab floor framing system contained roughly 166 angle sections, all varying in types and lengths. The final angle section selections can be found in Appendix E under the sheets labeled “L 2 Final”, “L 3 Final” and “L 4 Final”. In the labeled plans in found in Section 3.3, angle sections were added to every W-shape that was either kept or added.

In some cases, one angle section was not strong enough to hold up the load for every length of a W-shape; some members required multiple sections of an angle section to be added. As seen in Figure 13, four angle sections are attached to a W-shape. They vary in size because of different loading conditions.

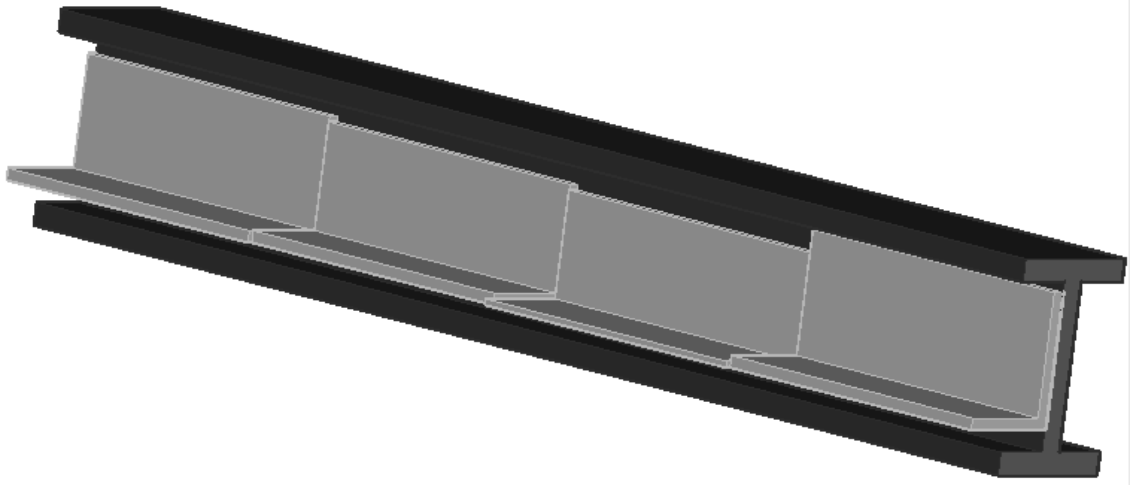

Figure 13 Angle Section Configuration Example

If the tributary widths of the angle sections were not so large, there would have been fewer cases where it was necessary to split the angle section into multiple sections. Splitting the angle sections poses no inconvenience from the design perspective, but definitely requires more time and money to implement in the field.

4 Design of the Alternative Weather-Exposed Column Connections.

The current pinned connection design for the AESS columns is intricately designed to resist weathering and to appeal to viewers and building users, due to being exposed from the building and in plain view. Although pinned connections are often times a lot simpler than fixed connections, the added detail in the current pinned connection designs can typically lead to higher manufacturing and installation times. Simpler, fixed column connections designs were investigated focusing on the base of the columns. The fixed design would not only increase the strength of the columns themselves by reducing the slenderness ratio $\frac{KL}{r}$, but also resist a moment along with the current axial and lateral loads. In order to investigate a simpler design a structural analysis on the building's current column connection design was performed.

4.1 Structural Analysis Process

The structural analysis on the current column connection design was used as a basis for the fixed connection design. ASCE 7-05 procedures were used in order to determine loadings acting on the exposed columns. Using information obtained from the structural drawing notes and *Massachusetts State Building Codes*, an Excel sheet was generated with equations from ASCE 7-05, noted in Sections 2.3.3, and completed with known variables. Since the AESS columns were only supporting the canopy, any loads from the second, third or fourth floor were disregarded in determining the gravity loading system of the columns. The loads from the canopy acting on the column were used in the loading combination calculations to determine the forces acting within the column as shown in the table below.

Table 10 Canopy Loads

Type of Load	Distributed Load (PSF)
SDL (Dead) <i>*Note: This also includes the Wind Downward Pressure of 14 psf</i>	25
Snow	47
Wind Uplift	22

The lateral wind loads acting on the AESS columns were investigated using figures and charts taken from *IBC 2009* and applying the values to equations outlined in Method 1 of wind load calculations, found in ASCE 7-05 and discussed in Section 2.3.3. Positive and negative wind pressures were calculated acting laterally on the column using the building wind exposure category and wind speed as shown in Table 11 applied to the equations discussed in Section 2.3.3.

Table 11 Wind Loads

Wind Loads	
Basic Wind Speed	100 MPH
Wind load Importance Factor	1.0
Wind Exposure Category	B

All the variables known were inputted into the variables specified in the Excel sheet and the design wind loading was calculated acting on the columns. The spreadsheets that were created using the current design were used as a template to design the fixed column connections. The figure below illustrates the combined of the axial and wind lateral loads acting on each column.

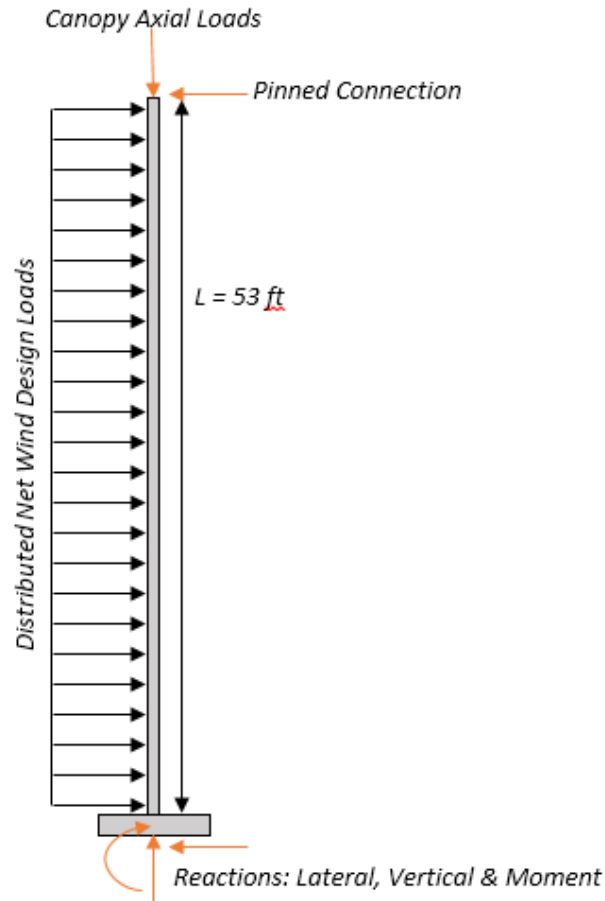

Figure 14 Free Body Diagram of Loads Acting on Columns

The Canopy Axial Load was determined by applying the canopy loads taken from the drawings, and applying them to the seven LRFD load combination equations. Due to the loads being in pounds per square foot, the loads were applied to the tributary width and length of the columns to obtain an axial point load on the column. Table 12 shows the axial load acting on the columns, with the largest value being the governing load.

THIS SPACE HAS BEEN INTENTIONALLY LEFT BLANK

Table 12 LRFD Loading Combinations Acting on the Columns

LRFD Load Combinations	Design Value (Lbs)	
1.4D	16,612.68	
1.2D + 1.6L + 0.5S	22,135.44	
1.2D + 1.6S + 0.8W	39,506.64	* Governs
1.2D + 1.6W + 1.0L + 0.5S	22,135.44	
1.2D + 1.0E + 1.0L + 0.2S	17,397.84	
0.9D + 1.6W + 1.6H	22,506.78	
0.9D + 1.0E + 1.6H	14,239.44	

Fixed Column Connection Design

The design of the fixed column connections started with sizing of the metal baseplates at the base of each column. The current baseplate dimensions of 2 ft x 2 ft were taken as a basis for design. The current design took into account the four A490 1” diameter bolts used to connect the plate to the footing. Using the information calculated regarding the current gravitational loading system, see table above, hand calculations to determine the dimensions of the moment resisting steel baseplate can be found in Appendix F. With modification made to the equations to adhere to the AESS column HSS-shape, the values derived from drawings and the previous calculations are below.

THIS SPACE HAS BEEN INTENTIONALLY LEFT BLANK

Table 13 Variable Used in Metal Baseplate Design

Given/ Calculated Variables	Values (units given)
Column Diameter	12.75 in
Column Weight	65.48 lbs/ft.
Concrete Compressive Strength, f'_c	4 ksi
Plate Yield Strength, f_y	36 ksi
Moment, M_u	0.791 ft.-kips

The new required area of the baseplate was calculated. With changes in the baseplate design, a new pier and footing area that would match the newly designed steel baseplate area were determined.

Due to the added moment that comes with a fixed connection design, the footing also needed to be redesigned to resist a moment and adhere to the changes in the dimensions of the steel baseplate. The rebar configuration in the footing was disregarded due to time constraints, but the added strength in the footing was generated with the newly designed area. The new footing area was calculated using procedures from ASCE 7-05 as described in Section 2.3.3.

4.2 Outcomes & Analysis

The calculations performed for the steel plate selection yielded the following results:

Table 14 Steel Plate Dimensions

COLUMN	Area (Square Inches)	Side Length (Inches)	t_{reqd} (Inches)	f_y (psi)
A6	365.77	19.25	1.25	36,000
B6	365.77	19.25	1.25	36,000
C6	365.77	19.25	1.25	36,000
D6	365.77	19.25	1.25	36,000

The bolt configuration remains the same, 4 1” diameter A490 bolts per plate. For a visualization of these dimensions, please see Figure 15 steel baseplate design.

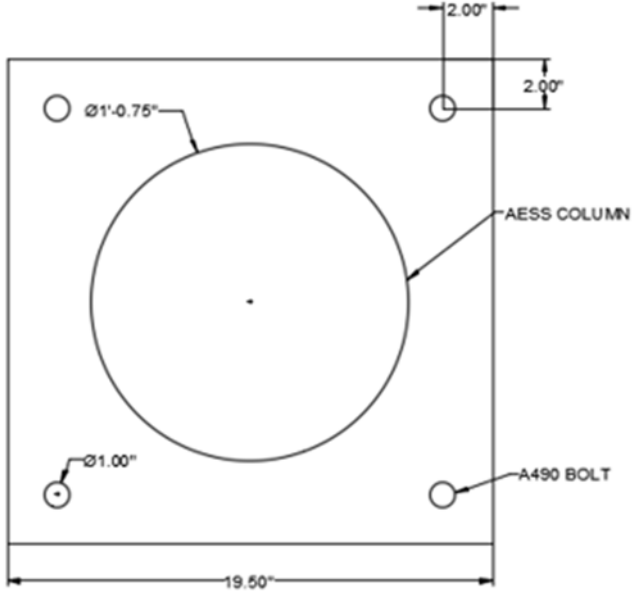

Figure 15 Steel Baseplate

Compared to the original dimensions, the new steel plate dimensions are slightly larger. The original dimensions are as follows:

Table 15 Original Steel Plate Dimensions

COLUMN	Area (square inches)	Side Length (inches)	t_{reqd} (inches)	f_y (psi)
A6	324.00	18.00	2.00	36,000
B6	324.00	18.00	2.00	36,000
C6	324.00	18.00	2.00	36,000
D6	324.00	18.00	2.00	36,000

The calculations performed for the footing dimensions yielded the following results:

Table 16 Pier Dimensions

Column	Area (square inches)	Effective Depth (ft)	Bolt Type
A6	576	2.75	1" diameter – A325
B6	576	2.75	1" diameter – A325
C6	576	2.75	1" diameter – A325
D6	576	2.75	1" diameter – A325

Compared to the original dimensions of the pier and footing, the dimensions didn't change for the new steel plate area.

The new steel baseplate dimensions are larger than the original dimensions due to the added moment from the fixed connection design. The dead and live loads on columns A6, B6, C6 and D6 remained the same since there was no added loading, just the change in the connection. The geometric constraints on the original steel baseplate were not as restricting on the new one, but still ultimately drove the design decision.

The required steel baseplate areas for both the old and new loading conditions were smaller than the cross-section of the connection attached to its top. The original steel baseplate required area was smaller than the cross-sectional area of the pin and the new steel baseplate required area was smaller than the cross-sectional area of the column. Therefore, both steel baseplates were selected based on geometry, not on loading capacity in order to comply with the welding of the baseplate to the column. If the column or pin were smaller than the required steel baseplate area, then the selection of the baseplates would have been driven by the loading capacity of the baseplate.

Although the steel plate dimensions increased to account for the new fixed design, the footing dimensions remained the same. When calculating the dimensions of the footing using the equations outlined in Section 2.3.3, the dimensions calculated were much smaller than the original dimensions. This was due to the small loadings that the AESS columns had to withstand,

because they were only supporting a marginal load from the canopy and the wind loads weren't significant. It was determined that the original dimensions of the footings were designed primarily on the geometry of the connections, so for ease of construction the footing dimensions will remain the same due to little to no change in the original dimensions.

5 Cost Estimates

The objective of this chapter is to develop a cost estimate for both the current and alternative designs of the foundations and floor framing systems. The type of cost estimate used for this project is a unit cost estimate. The cost estimates take into account material costs, labor costs, equipment costs, and overhead and profit for the CM. The source of cost data used for this project is the *RS Means Construction Cost Data Books* published in 2012. The majority of the material quantities were obtained by generating material schedules from the *Revit* models, explained in Chapter 7, for the current and Girder-Slab design and exporting them to Excel spreadsheets. When the quantities could not be generated from the BIM model, the information was taken off the scanned copies of the blueprints with the aid of *On-Screen Takeoff 3*, which is explained in Chapter 7.1. Figure 16 below shows a summary of the process used to generate the cost estimates.

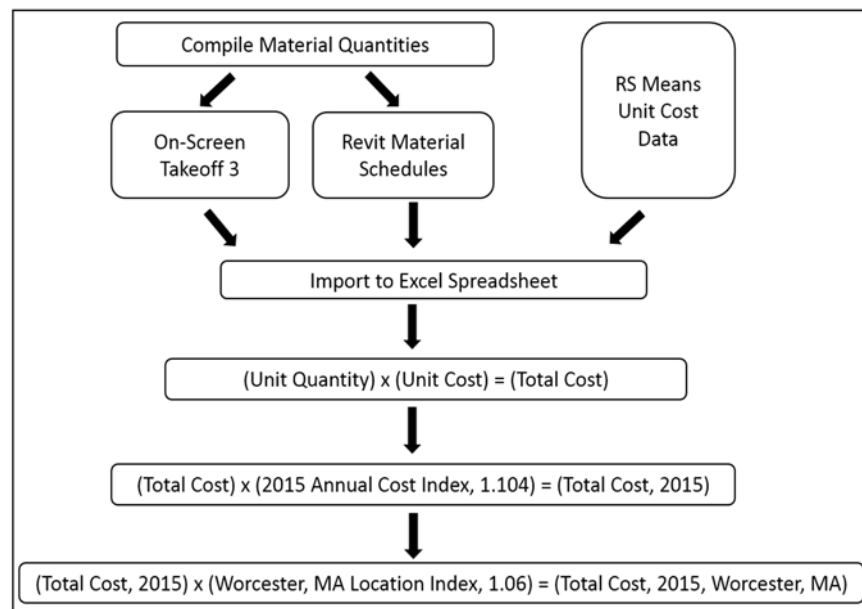

Figure 16 Cost Estimate Process Flowchart

5.1. Cost Estimate Preparation for the Existing Structural Systems

To create a cost estimate for the foundations, structural steel framing and slab-on-metal decking for the current building, an Excel document with all of the *RS Means* Cost data was compiled. The material quantities from the material schedules generated in *Revit* (see Chapter 7.1) were entered into this Excel sheet. The total cost of the items were obtained by direct multiplication of the total quantity of the item with its corresponding unit price. For the steel beams and columns, a cost calculator spreadsheet was generated. This spreadsheet was used to break the cost of the steel structure down by phase. After the cost estimate was generated, an annual cost index, 1.104, for the year 2015 was applied because the *RS Means* books presented cost data for 2012. This adjustment factor accounts for the increases of cost over time. A location adjustment factor, 1.06, was also applied because the project takes place in Worcester, Massachusetts, which has higher construction costs than the national average. This process of creating a cost estimate was carried out for the steel frame, foundations, and slab-on-metal decking/precast concrete planks of the current design. See Appendix G for the foundation cost estimate, Appendix H for the slab-on-metal decking cost estimate, and Appendix I for the steel cost calculator used to generate the cost of each steel beam by linear foot.

5.2. Cost Estimate Preparation for the Girder-Slab Design

Using a similar method, a second cost estimate was then created for the structural steel frame and precast concrete planks of the Girder-Slab design. From the *Revit* model (discussed in Chapter 7.2) of the alternative design, material schedules were exported into Excel spreadsheets and used for the cost estimate. A cost estimate for the foundation was not re-calculated as the foundation for the alternative design did not change from the current design to the alternative design. The cost estimate for the precast concrete planks was generated by multiplying the

quantity (square feet) of precast concrete planks by the provided unit cost from the *RS Means* data.

The *RS Means Construction Costs Data Books* do not contain cost data for D-beams. To establish an average price per pound of steel for the D-beams, the cost of 26 different W-shapes were averaged and divided by the total pounds. The cost estimate for the D-beams was then generated by multiplying the total weight of the steel by the calculated average price per pound.

After the cost estimate for the alternative floor system was generated, the time and location adjustment factors used for the current structure cost estimate were applied. See Appendix J for the precast concrete planks cost estimate and Appendix K for the calculations used to find the average price of the D-beams.

To determine the least expensive building design the cost estimates for the foundation, steel, and slab-on-metal decking/ precast concrete planks for the current and alternative design were compared with one another and as a whole.

5.3 Cost Estimate Outcomes

The following results provide a breakdown of the cost estimates for foundation, steel, and concrete flooring for both the existing and alternative designs. The costs were determined for level one through the roof level. Overall, as shown below in Table 17, the total cost estimate of the existing design is \$2,205,052 which includes the cost estimate of the foundation, structural steel and concrete flooring. The total cost estimate for the Girder-Slab design is \$2,002,912 which includes the foundation, structural steel, and concrete flooring. The cost of the Girder-Slab design ended up being \$202,140, which is about 10% less than the current design.

Table 17 Cost Estimate of Current Design vs. New Design

	Existing Design	New Design	Savings
Foundation	\$294,707	\$294,707	\$0
Steel	\$1,241,862	\$1,138,776	\$103,086
Concrete Flooring	\$668,483	\$569,428	\$99,054
Total	\$2,205,052	\$2,002,912	\$202,140

The cost estimate of the foundation for both the current and alternative designs is \$294,707. This estimate includes the price of the concrete footings, piers, foundation walls, elevator and stairwell shafts, and mat slab foundations for the elevator and stairwells. This estimate did not change as there were no design changes to the foundation in the Girder-Slab building design.

A breakdown of the estimate by phase is shown below in Table 18. Phase 1 is four 8FT by 8FT interior footings. Phase 2 is the elevator mat slab. Phase 3 is the stair mat slabs and 5 LF of piers. Phase 4 is two 8FT by 8FT interior footings, nine 7FT by 7FT exterior footings, four 11FT by 11FT footings, and 109 LF of piers. Phase 5 is the cinderblock walls for the stairwell. Phase 6 is the foundation walls. Phase 7 is the cinderblock walls for the elevator.

Table 18 Foundation Cost Estimate by Phase

Phase	Cost
1	\$8,683
2	\$16,050
3	\$84,357
4	\$38,785
5	\$26,488
6	\$39,854
7	\$80,490
Total	\$294,707

The cost of the steel frame for the current design is \$1,241,862 which includes the cost of all of the steel beams (W-shapes), girders (W-shapes), and columns in the building. The estimate for the Girder-Slab design is \$1,138,776 which includes all of the steel beams (W-shapes), girders (D-beams), and columns. The cost of the steel frame was \$103,086 less for the alternative design due to the replacement of W-shape girders with a lighter weight system of D-beams. The reduced weight of steel simply translated into reduced cost. A breakdown of the estimate by level is shown in Table 19 below. Below, Columns 1-3 refer to all structural columns for levels one through three and the exterior AECS columns which run from level one to the canopy. Columns 4 through Canopy are the columns that run from level four to the canopy. The cost of the AECS columns does not include the extra coatings for weatherproofing.

Table 19 Steel Cost Estimate by Level

	Existing Design	Girder-Slab Design
Level	Cost	Cost
2nd Floor	\$167,047	\$147,558
3rd Floor	\$149,217	\$91,085
4th Floor	\$139,689	\$114,224
Roof	\$147,809	\$147,809
Canopy	\$421,584	\$421,584
Columns 1-3	\$182,509	\$182,509
Columns 4-Canopy	\$20,124	\$20,124
Exterior Framing	\$13,883	\$13,883
TOTAL COST	\$1,241,862	\$1,138,776

The cost estimate for the concrete flooring for the current building design was \$668,483 which includes the slab-on-grade of the first floor, and slab-on-metal-decking for floors two, three, four and the roof. The cost estimate for the concrete flooring for the new design is \$569,428 which includes the slab-on-grade of the first floor, precast concrete planks for floors two, three, and four, and slab-on-metal decking for the roof. The cost difference between the

two concrete flooring designs is \$99,054. A breakdown of the estimate by floor is shown below in Table 20.

Table 20 Concrete Flooring Cost Estimate by Floor

	Concrete Slab	Concrete Planks
Floor	Cost	Cost
Slab on Grade	\$142,437	\$142,437
2nd floor	\$126,320	\$94,415
3rd floor	\$123,524	\$106,051
4th floor	\$148,117	\$98,442
SOMD Roof	\$128,084	\$128,084
TOTAL	\$668,483	\$569,429

The cost impact to the current and Girder-Slab design is further explored in Chapter 7 where it is implemented into a 5D model of the structures.

6 Girder-Slab Project Schedule

The objective of this chapter was to develop a project schedule for the Girder-Slab floor framing system. Owner's meetings on the ASEC site were attended to gain information on the current building. The meetings provided insight about the project progress by obtaining meeting minutes, participating in site tours, and asking questions about the project to the Project Manager (PM) and the Assistant Project Manager (APM). The meeting minutes contained four-week look ahead schedules which have assisted with the process of generating project schedules.

6.1 Scheduling Process

To create this schedule, the structural activities of the CM's project schedule were entered into the scheduling software, *Microsoft Project*, found in Appendix L. The Girder-Slab floor framing design can be found in Appendix M. Information about the installation process provided by Mack Industries, Inc (Mack Industries, 2015). for the Girder-Slab materials such as precast concrete planks and D-beams can be found in the background section. The Girder-Slab schedule takes into account the lead-time information for obtaining the Girder-Slab materials. To create the new Girder-Slab schedule the tasks "Place SOMD" (slab-on-metal decking) were replaced with "Place Concrete Planks". A new task was added following placement of the precast concrete planks titled "Grout Floor #". Also, the tasks titled "Install Metal Decking/Detail Metal Deck" were deleted for the girder-slab schedule. Figure 17 shows the comparison of the two schedules for installing the concrete flooring.

Slab-on-Metal Decking Schedule

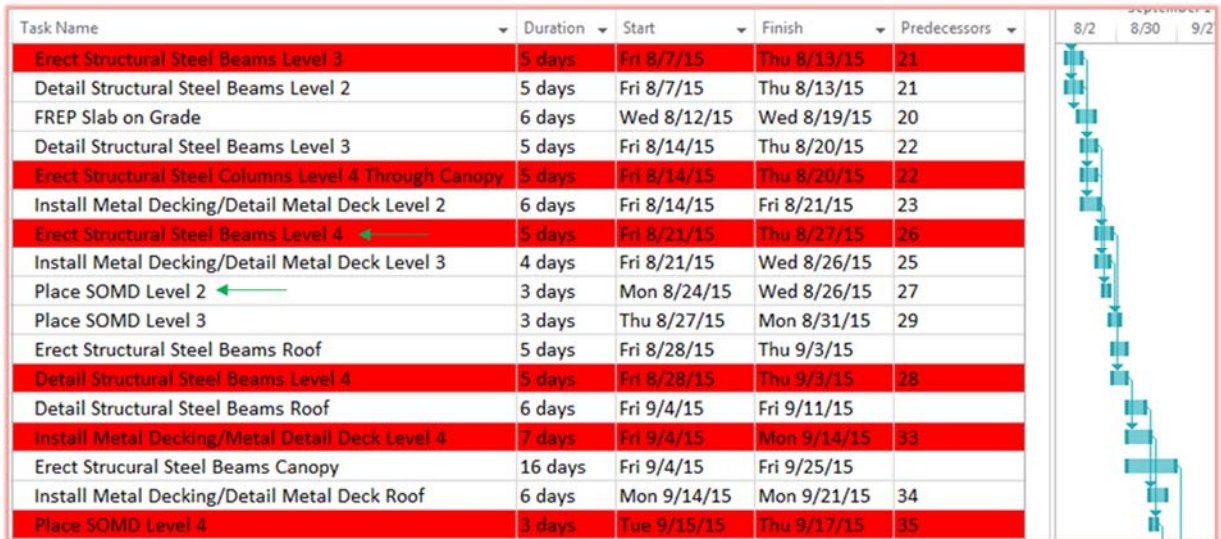

Girder-Slab Schedule

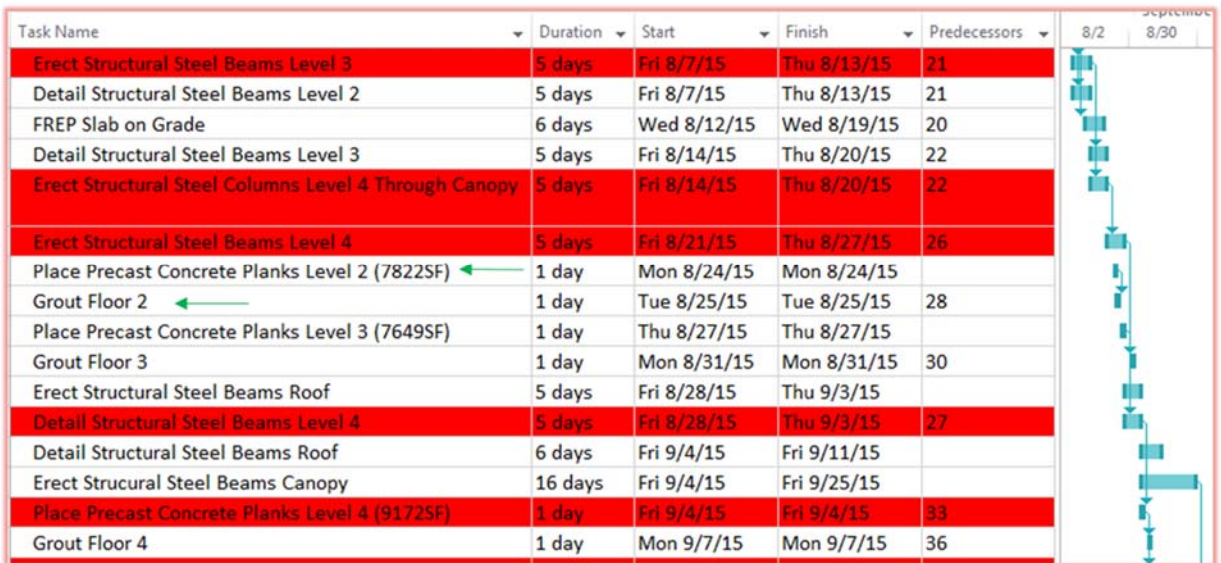

Figure 17 Floor Framing System Schedules

The green arrows indicate the activities that are different between the slab-on-metal decking schedule to the Girder-Slab schedule. These differences are due to the distinct elements of each floor system. The red highlighted tasks in Figure 17 are referring to the critical path. The total construction time of the current floor framing system and the Girder-Slab floor framing system were compared.

6.2 Scheduling Outcomes

The schedules created for the both the current building design and the Girder-Slab building design consist of the preconstruction and construction tasks for the development of the structural aspects of the building. To aid creation of the Girder-Slab schedule, information about the installation process for the D-beams and the precast concrete planks provided by Mack Industries, Inc. was used (Mack Industries, 2015). The CM's provided schedule was compared with the four-week look ahead schedules provided in the owner's meeting minutes to determine delays while placing the concrete on the floors. From attending the owner's meetings, it was determined that there was a three day delay caused by rain which affected the pouring of the concrete. The CM was notified by the structural engineers that the order in which the floors were to be placed was not reflected in the original schedule. In the schedule, the order of placing the floors was supposed to be level two, level three, and then level four. However, due to loading constraints the order of placing the floor was level three, all of level two except for the balcony, level four, and then the balcony on level two.

The main focus of comparing the two schedules is to discover the differences in the installation process of the two separate floor framing systems and the impact of the proposed alternative on the schedule. The figure belows shows an excerpt of the installation process for the two designs.

Slab-on-Metal Decking Schedule

Task Name	Duration	Start	Finish	Predecessors
Erect Structural Steel Beams Level 3	5 days	Fri 8/7/15	Thu 8/13/15	21
Detail Structural Steel Beams Level 2	5 days	Fri 8/7/15	Thu 8/13/15	21
FREP Slab on Grade	6 days	Wed 8/12/15	Wed 8/19/15	20
Detail Structural Steel Beams Level 3	5 days	Fri 8/14/15	Thu 8/20/15	22
Erect Structural Steel Columns Level 4 Through Canopy	5 days	Fri 8/14/15	Thu 8/20/15	22
Install Metal Decking/Detail Metal Deck Level 2	6 days	Fri 8/14/15	Fri 8/21/15	23
Erect Structural Steel Beams Level 4	5 days	Fri 8/21/15	Thu 8/27/15	26
Install Metal Decking/Detail Metal Deck Level 3	4 days	Fri 8/21/15	Wed 8/26/15	25
Place SOMD Level 2	3 days	Mon 8/24/15	Wed 8/26/15	27
Place SOMD Level 3	3 days	Thu 8/27/15	Mon 8/31/15	29
Erect Structural Steel Beams Roof	5 days	Fri 8/28/15	Thu 9/3/15	
Detail Structural Steel Beams Level 4	5 days	Fri 8/28/15	Thu 9/3/15	28
Detail Structural Steel Beams Roof	6 days	Fri 9/4/15	Fri 9/11/15	
Install Metal Decking/Metal Detail Deck Level 4	7 days	Fri 9/4/15	Mon 9/14/15	33
Erect Structural Steel Beams Canopy	16 days	Fri 9/4/15	Fri 9/25/15	
Install Metal Decking/Detail Metal Deck Roof	6 days	Mon 9/14/15	Mon 9/21/15	34
Place SOMD Level 4	3 days	Tue 9/15/15	Thu 9/17/15	35

Girder-Slab Schedule

Task Name	Duration	Start	Finish	Predecessors
Erect Structural Steel Beams Level 3	5 days	Fri 8/7/15	Thu 8/13/15	21
Detail Structural Steel Beams Level 2	5 days	Fri 8/7/15	Thu 8/13/15	21
FREP Slab on Grade	6 days	Wed 8/12/15	Wed 8/19/15	20
Detail Structural Steel Beams Level 3	5 days	Fri 8/14/15	Thu 8/20/15	22
Erect Structural Steel Columns Level 4 Through Canopy	5 days	Fri 8/14/15	Thu 8/20/15	22
Erect Structural Steel Beams Level 4	5 days	Fri 8/21/15	Thu 8/27/15	26
Place Precast Concrete Planks Level 2 (7822SF)	1 day	Mon 8/24/15	Mon 8/24/15	
Grout Floor 2	1 day	Tue 8/25/15	Tue 8/25/15	28
Place Precast Concrete Planks Level 3 (7649SF)	1 day	Thu 8/27/15	Thu 8/27/15	
Grout Floor 3	1 day	Mon 8/31/15	Mon 8/31/15	30
Erect Structural Steel Beams Roof	5 days	Fri 8/28/15	Thu 9/3/15	
Detail Structural Steel Beams Level 4	5 days	Fri 8/28/15	Thu 9/3/15	27
Detail Structural Steel Beams Roof	6 days	Fri 9/4/15	Fri 9/11/15	
Erect Structural Steel Beams Canopy	16 days	Fri 9/4/15	Fri 9/25/15	
Place Precast Concrete Planks Level 4 (9172SF)	1 day	Fri 9/4/15	Fri 9/4/15	33
Grout Floor 4	1 day	Mon 9/7/15	Mon 9/7/15	36

Figure 18 Floor Framing System Schedules Comparison

Through comparison of the critical path (highlighted in red) of both schedules for constructing the floor framing systems, it was determined that the installation process for the Girder-Slab design is nine working days faster than that for the slab-on-metal decking process. The start date for the structural floor framing system for the current design is 7/31/15 and the end date is 9/17/15. The start date for the structural floor framing system for the current design is 7/31/15

and the end date is 9/3/15. Both schedules have the same start date (3/12/15), but the critical path was shortened by nine days. Therefore the critical path for the Girder-Slab floor framing schedule would have ended on 9/28/15 and the current floor framing schedule ended on 10/9/15. The concrete planks had a faster installation rate compared to that for the slab-on-metal decking. However, it is important to note that typically the metal decking and concrete are readily available versus the precast plank system. Therefore, Girder-Slab schedules must incorporate lag and lead times for the material production.

7 Current & Alternative Design 5D Models

The main objective of this chapter was to create 5D models using BIM software tools for both the current and alternative design, incorporating the cost and schedule. This section discusses the steps taken to complete the final 5D models of both the current and the alternative structural layouts the results. While using the ASEC's construction structural drawings provided by the construction management firm, a 3D *Revit* model was created of the current building with measurements taken using *On-Screen Takeoff 3*. Once the new Girder-Slab design was established, another 3D *Revit* model was created using a similar layout of the current building and replacing the current floor framing system with the proposed Girder-Slab system. To produce a simulation of the construction process, the costs and the project schedules for both building models were implemented into a *Navisworks* model also known as a BIM model. This process resulted in two separate BIM models of the current and alternative building designs which were used to compare the two designs in terms of construction efficiency and cost effectiveness.

7.1 Current Building Revit Model Process & Outcome

Autodesk Revit 2016 was used to create a 3D model of the current building. The structural floor framing plans were used to create the current building by using 3D building objects representing the actual sizes and materials as used in the current design. *On-Screen Takeoff 3* was used to establish values for the dimensions which were not given in the drawings. Figure 19 is a visual representation of how this software was used to obtain dimensions not explicit provided in the drawings.

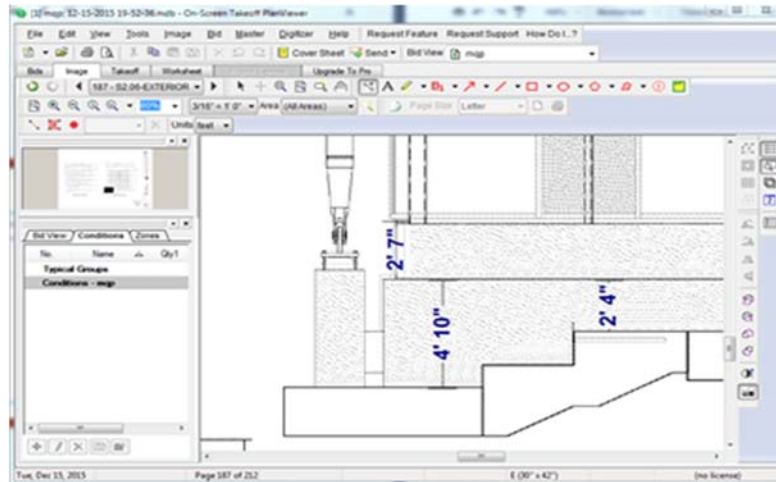

Figure 19 On-Screen Takeoff 3 Measurement Example

On-Screen Takeoff 3 was a valuable software tool when creating the foundation walls of this building which helped the modeling process move smoothly due to the changing geometry of the walls. The current building design model consists of 3D objects representing steel W-shapes, HSS beams, structural columns, slab-on-metal decking flooring, and the foundation of the building. The model also provides a phasing breakdown that allows the user to make graphic representations of the gradual construction of the project which was determined in Chapter 6. The schedule was modified into 23 phases to support the *Revit* model of the current design. The phasing plan was a useful tool because it allowed for all of the building objects in the model to be assigned to a corresponding construction phase. *Revit* provides schedules or lists that help identify the quantity, family, type of material and the phase in which it was created. This tool can provide a variety of information about the model. The schedules created in the *Revit* file were used for the cost estimates found in Chapter 5. Material schedules with quantities of work can then be generated by phase and used to create a cost estimate for each phase of the construction process. Figure 20 provides an example of the information extracted from the *Revit* model to produce a cost estimate.

<Structural Framing Schedule>				
A	B	C	D	E
Count	Cut Length	Family	Phase Created	Type
1	31' - 2 1/2"	W-Wide Flange	Phase 13	W21X50
1	31' - 2 1/2"	W-Wide Flange	Phase 13	W18X50
1	31' - 2 1/2"	W-Wide Flange	Phase 13	W21X50
1	31' - 2 1/2"	W-Wide Flange	Phase 13	W21X50
1	17' - 1 1/2"	W-Wide Flange	Phase 12	W18X35
1	30' - 11 1/2"	W-Wide Flange	Phase 12	W18X35
1	31' - 4 1/2"	W-Wide Flange	Phase 12	W18X35
1	17' - 2 1/2"	W-Wide Flange	Phase 12	W21X50
1	31' - 2 1/2"	W-Wide Flange	Phase 12	W21X50
1	31' - 2 1/2"	W-Wide Flange	Phase 12	W21X50
1	31' - 2 1/2"	W-Wide Flange	Phase 12	W21X50
1	31' - 2 1/2"	W-Wide Flange	Phase 12	W21X50
1	31' - 5"	W-Wide Flange	Phase 12	W18X35
1	17' - 1 1/2"	W-Wide Flange	Phase 12	W18X35
1	17' - 1 1/2"	W-Wide Flange	Phase 12	W18X35
1	31' - 5"	W-Wide Flange	Phase 12	W18X35
1	30' - 9"	W-Wide Flange	Phase 12	W27X102
1	30' - 8 1/2"	W-Wide Flange	Phase 12	W18X35
1	30' - 8 1/2"	W-Wide Flange	Phase 12	W27X102
1	3' - 5"	HSS Square	Phase 12	HSS4X4X3/8
1	3' - 4"	HSS Square	Phase 12	HSS4X4X3/8
1	3' - 5 1/2"	HSS Square	Phase 12	HSS4X4X3/8

Figure 20 Structural Steel Framing Material Schedule

This figure shows a list of structural steel framing elements that are part of the current building model. The following figure presents a 3D visual representation of the current building.

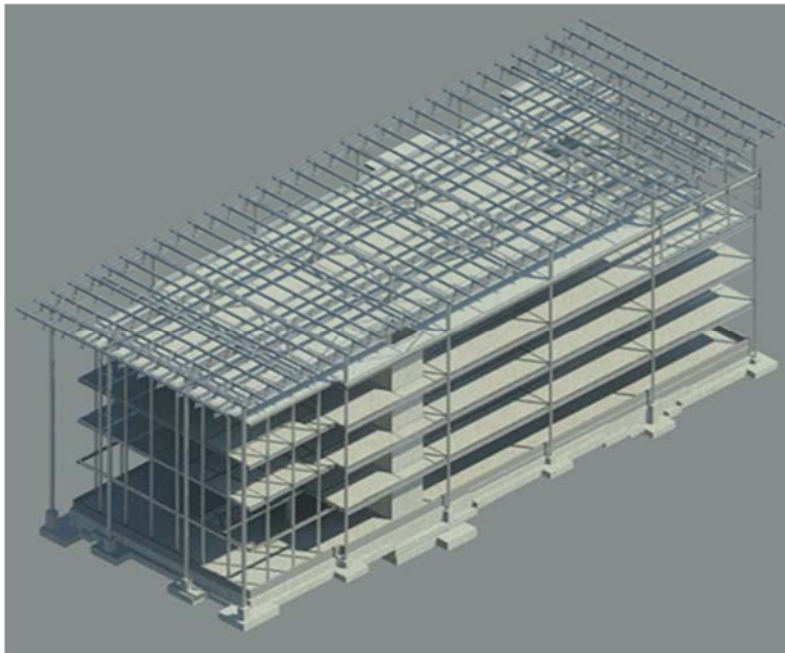

Figure 21 Current Building Design Revit Model

For a more detailed visual representation and specifications please refer to Appendix N, the *Revit* Model file for the current building design. This model is only to be used to show a visual representation of the building, it does not contain all the details of the structural 2D drawings.

7.2 Girder-Slab Building Design Revit Model Process & Outcome

The 3D model of the current building was used as a template for implementing the new Girder-Slab design. Once the elements of the new design were established, a 3D model was created. The new design was based off the calculations and marked construction drawings as seen in Section 3.3. The girders of the current building model were replaced with D-beams in the Girder-Slab model on the second, third, and fourth floor as shown in the figure below. Girder-Slab System provided all 3D D-beam objects which were implemented into the Girder-Slab design model for ASEC. The D-beam layout of each floor was designed to have D-beams span north-south to eliminate W-shaped beams. The figure below compares a section of the structural configuration of the 4th floor structural plan of the current design with the same section of the Girder-Slab Design of the 4th floor.

THIS SPACE HAS BEEN INTENTIONALLY LEFT BLANK

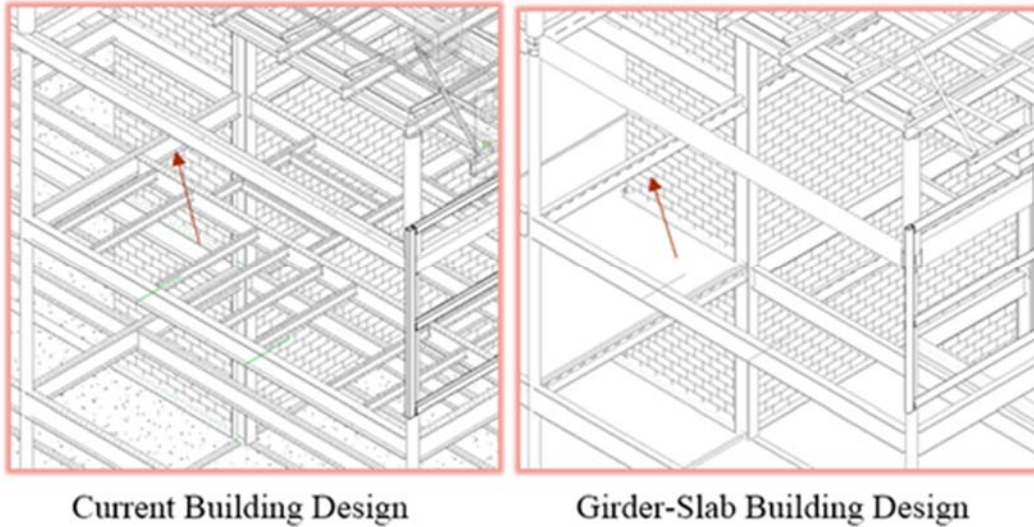

Figure 22 Current vs. Girder Slab Building Design Level 4

The figure above shows both the current and Girder-Slab design focused on the fourth floor of each design. Please note that flooring elements and the exterior framing were hidden in the figure to allow easy viewing. The arrows are pointing to the same beam location. The arrow on the left is pointing to a W18X35 in the current building design which was then replaced by a DB9X65 in the Girder-Slab building design. Differences between the two models can be observed from the figure. For example, the current building design shows more W-shaped beams on the fourth floor running both north-south and east-west to support the required load. The Girder-Slab building design shows that infill beams were omitted because the Girder-Slab has the capacity for longer spans.

THIS SPACE HAS BEEN INTENTIONALLY LEFT BLANK

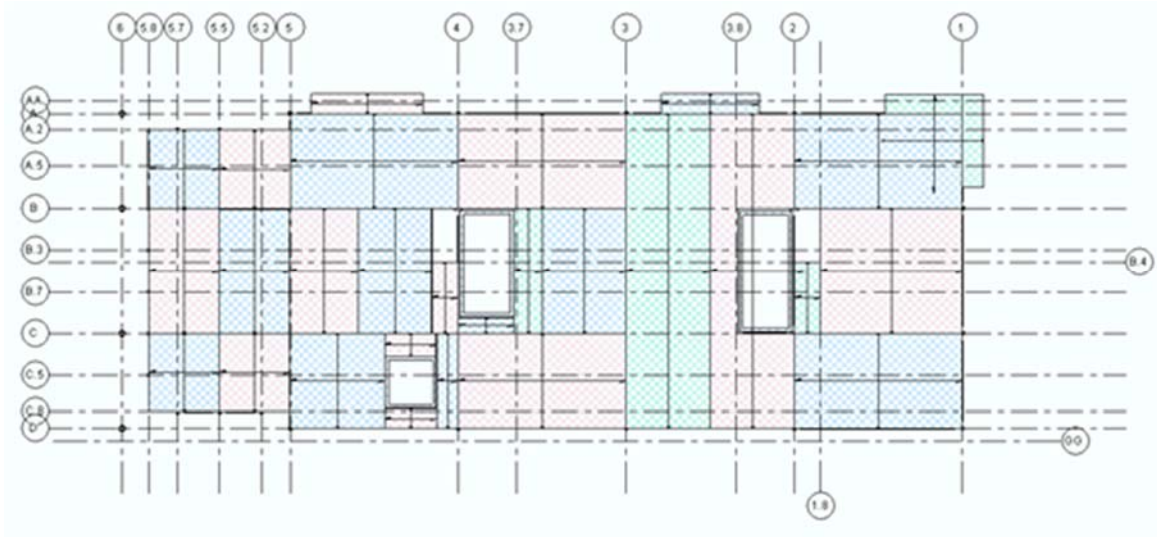

Figure 23 Precast Concrete Planks Layout for Level 3

The Girder-Slab precast concrete planks are designed to be installed in sections. Precast concrete slabs were 3D objects used in the Girder-Slab model replacing the slab-on-metal decking. Figure 23 above shows an example of the layout sections on the third floor. The different colors in the figure are used to show the different precast slab sections. The precast concrete slabs are only installed on the second, third, and fourth floor. The roof remains slab-on-metal decking and the first floor remains slab-on-grade. The roof, canopy, and the column design remains the same as in the current building design for the Girder-Slab building design. The major changes pertain to the second, third, and fourth floor as well as a minor adjustment to the foundation steel plates. For a more detailed visual representation and specifications please refer to Appendix O, the *Revit* Model for the Girder-Slab design file. This model is only to be used to show a visual representation of the building, it does not contain all the details of the structural 2D drawings.

7.3 Implementation 5D Models (Project Schedule and Cost Estimate) in Navisworks

The current design project schedule and the Girder-Slab project schedule were incorporated into the corresponding 3D models using *Navisworks* software. The schedule was added to the 3D model to enable a simulations of the construction process. Each 3D model was represented in separate *Autodesk Navisworks* files with the corresponding project schedules created in *Microsoft Project*. These schedules were broken down into twenty-three construction phases and linked to the model’s objects. This created a 4D model that visually aligns the schedule and construction process. Figure 24 shows an example of how the schedule for the Girder-Slab building design is represented in *Navisworks*.

Active	Name	Planned Start	Planned End	Total Cost	Qtr 2, 2015	
					May	
<input checked="" type="checkbox"/>	FREP Interior Spread Footings	5/21/2015	5/27/2015	8,683.18		
<input checked="" type="checkbox"/>	FREP Interior Footings/Mat/Slab for Elevator Shaft	5/22/2015	5/28/2015	16,049.84		
<input checked="" type="checkbox"/>	FREP Interior Footings for Stairwells	5/22/2015	5/28/2015	84,356.75		
<input checked="" type="checkbox"/>	FREP Perimeter Foundation Wall Footings	5/28/2015	6/10/2015	38,785.26		

Figure 24 Girder-Slab Building Design Schedule Example

The cost estimates of both designs were also applied to the corresponding *Autodesk Navisworks* models to integrate the cost of installing the different gravity load resisting systems. The price of each task can be found in the total cost column of the model. Adding the cost from the cost estimates from the Chapter 5 into the 4D models created two separate 5D models, one for each approach to the structural design.

7.4 Final 5D Model Rendering Process & Outcome

The separate models were rendered to show the gradual construction process of both the current and alternative building designs as shown in Appendix P and Appendix Q. The models show the cost and duration of each phase. The current building design and the new Girder-Slab

design 5D models are used to show the differences in the construction process and the cost. This is done by playing the models simultaneously to visually see the different construction durations and costs. The figures below are side-by-side comparisons of the two building designs.

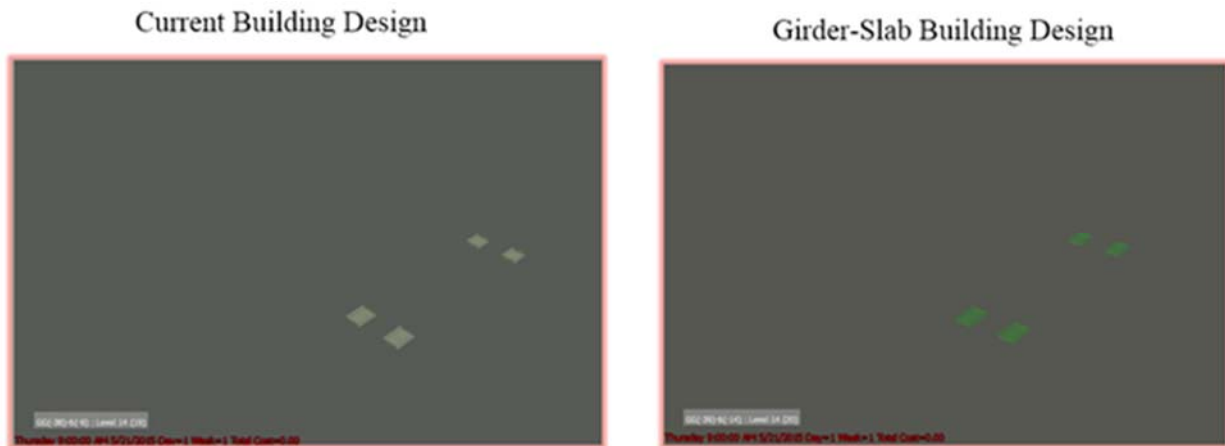

Figure 25 Current vs. Girder-Slab Building Design Week 1

The figure above shows both models at the start of the project. The start dates are the same and the total cost of the work for week one is zero dollars. On this week the interior footings are being constructed but they are not yet completed.

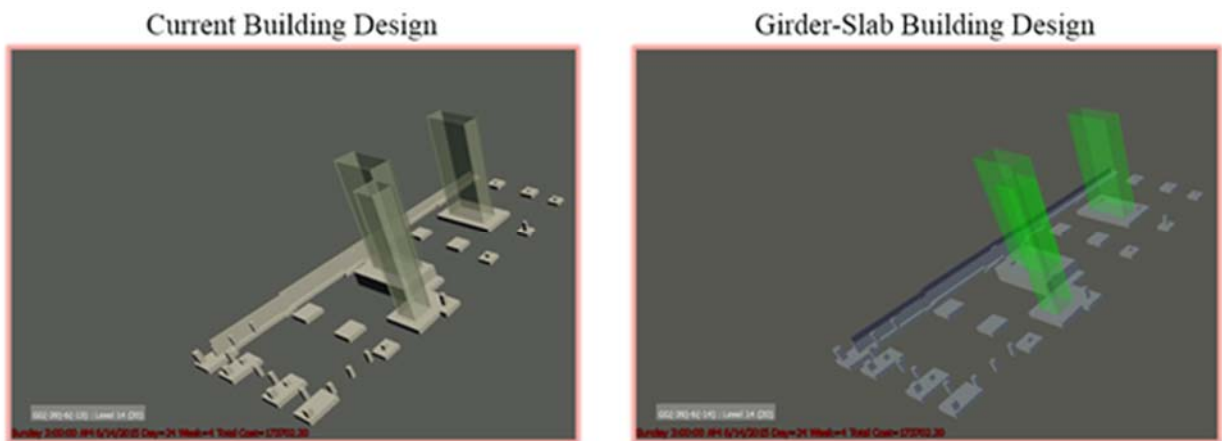

Figure 26 Current vs. Girder-Slab Building Design Week 4

The figure above shows both building design models at week four which is the completion of the foundation footings, piers, stairwell mat/concrete slab, and the elevator

mat/concrete slab. The total cost of the project at week four is \$173,702.30 for both models on 6/14/2015. The items that are translucent are currently being built.

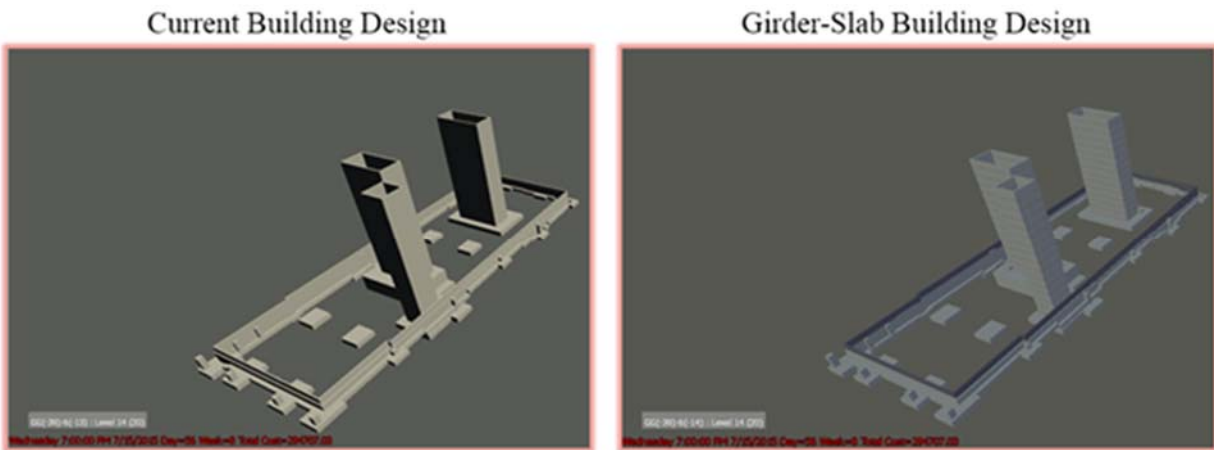

Figure 27 Current vs. Girder-Slab Building Design Week 8

Figure 27 portrays both buildings at week eight on 7/15/2015 which show the completion of the foundation walls, the elevator shaft tower and the stairwell shaft towers. The total cost of the project at week eight is \$294,707.03 for both projects.

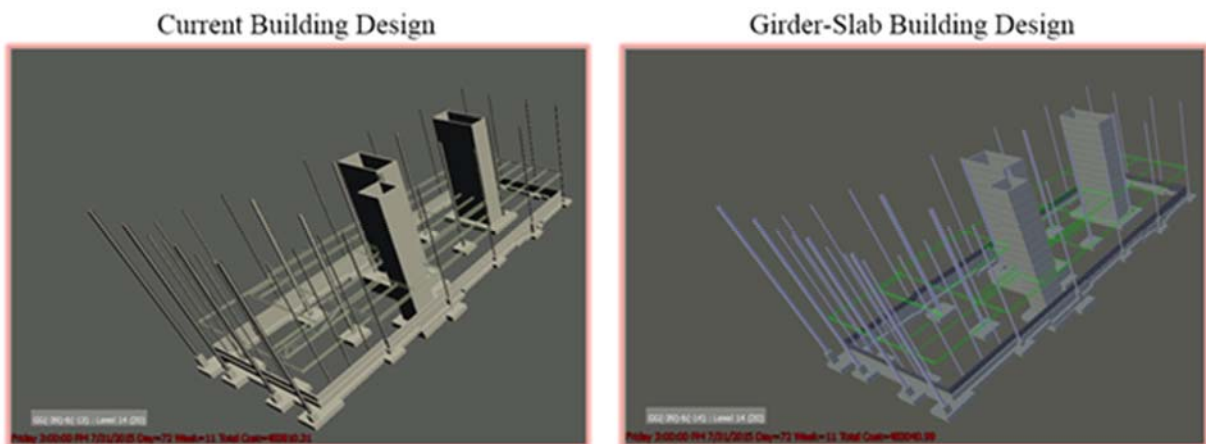

Figure 28 Current vs. Girder-Slab Building Design Week 11

The figure above represents week 11 for both building designs. The columns of levels one to three were constructed and level two structural steel beam construction was started. This resulted in the current building design model total cost to be \$483,810.31 and the Girder-Slab

building design total cost to be \$483,040.99 at week 11. The Girder-Slab building design is lower because there are less beams being constructed compared to the current building design on level two.

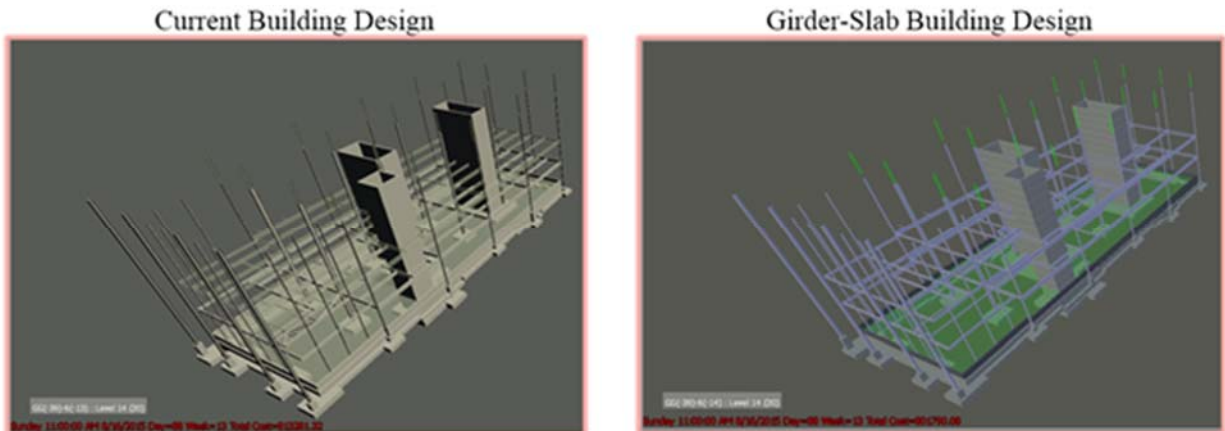

Figure 29 Current vs. Girder-Slab Building Design Week 13

The figure above shows both models at week 13. The current building design shows that the construction of columns for level four through canopy and the construction of level three structural steel beams were started. The current building design during this week resulted in a total cost of \$813,281.32. The Girder-Slab building design model shows the completion of the level two and three structural steel beams during this week. Also the construction of the columns for level four through canopy and the slab on grade at level one were started. The Girder-Slab design model resulted in a total cost of \$801,790.08 at week 13. The Girder-Slab building design was more time effective when constructing the floor framing system, and its cost was \$11,491.24 less than the current building design model at this week.

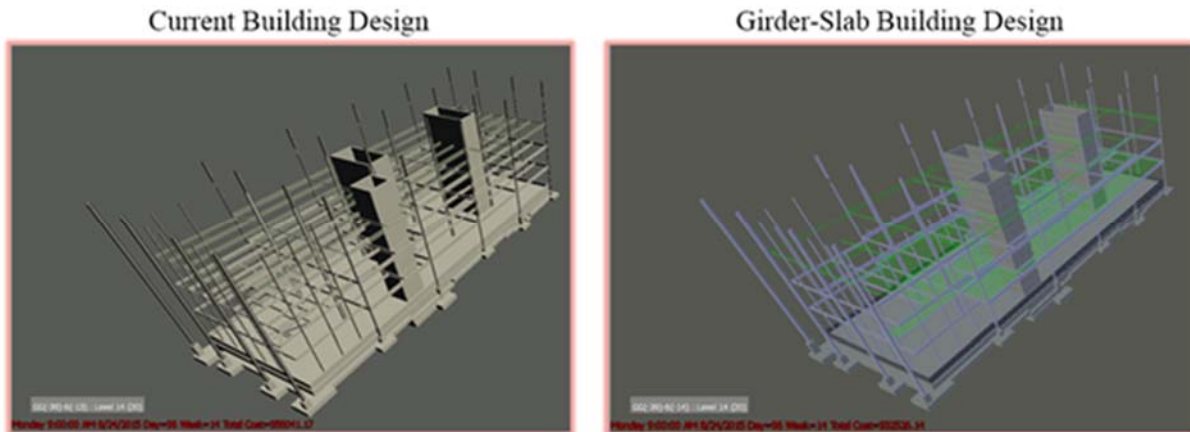

Figure 30 Current vs. Girder-Slab Building Design Week 14

The figure above shows both models at week 14. In the current building design the construction of columns for level four through canopy and the construction of the structural steel beams on level three were completed. The construction of level four structural steel beams was just started. The current building design during this week resulted in a total cost of \$956,041.17. The Girder-Slab building design model shows the completion of the columns for level four through canopy and the slab on grade at level one during this week. Also, the construction of the level four structural steel beams and the installation of the precast concrete planks on level two were started. The Girder-Slab design model resulted in a total cost of \$932,526.14 at week 14. The Girder-Slab building design was more time efficient when constructing the floor framing system, and its cost was \$12,023.79 less than the current building design model at this week which leads to a total savings of \$23,515.03.

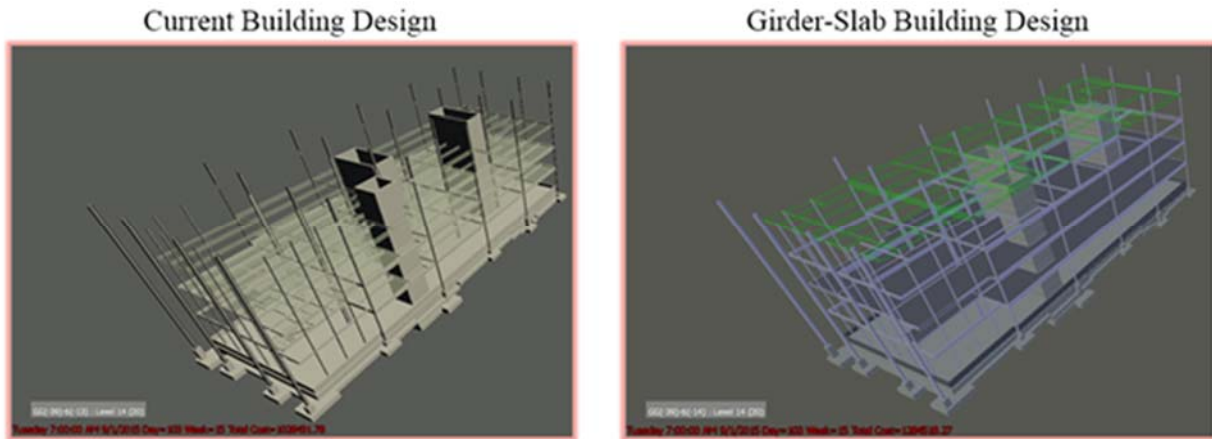

Figure 31 Current vs. Girder-Slab Building Design Week 15

The figure above represents both models at week 15. The construction of level four structural steel beams and installation of slab-on-metal decking for levels two and three were started. The current building design during this week resulted in a total cost of \$1,028,491.78. The Girder-Slab building design model shows the completion of level four structural steel beams and the installation of the precast concrete planks for level two and three during this week. Also the roof's structural steel beams construction was started. The Girder-Slab design model resulted in a total cost of \$1,284,518.27 at week 15. The Girder-Slab building design was more time efficient when constructing the floor framing system. During this week the cost of the current building model was \$232,508.46 less than the Girder-Slab design because the Girder-Slab building design has more phases completed than the current building design. The Girder-Slab building design has higher percent completion during this week, and therefore has more expenditures to date.

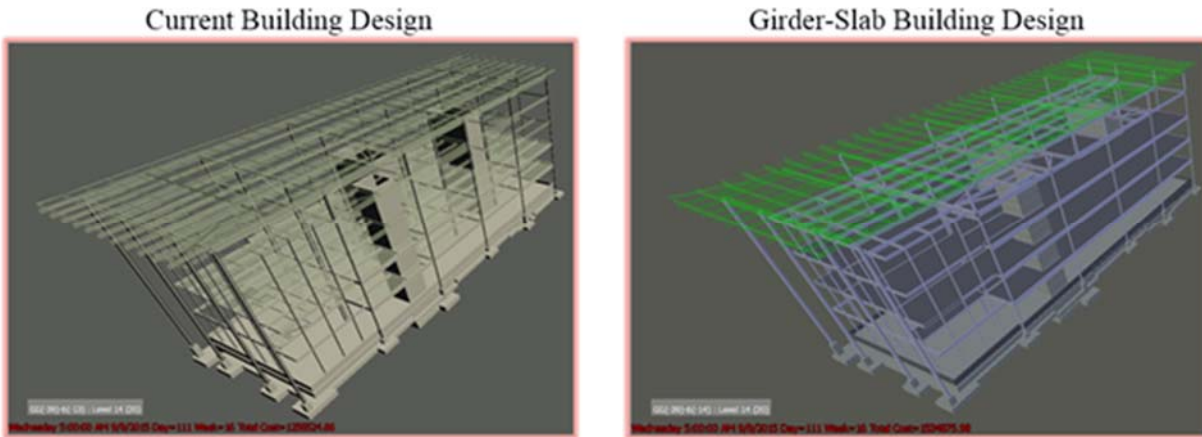

Figure 32 Current vs. Girder-Slab Building Design Week 16

The figure above represents both models at week 16. The construction of level four, the roof, and the canopy's structural steel beams and installation of slab-on-metal decking for levels two and three were started. The current building design during this week resulted in a total cost of \$1,256,524.66. The Girder-Slab building design model shows the completion of the roof's structural steel beams and the installation of the precast concrete planks for level four during this week. Also the construction of the canopy's structural steel beams were started. The Girder-Slab design model resulted in a total cost of \$1,534,875.98 at week 16. The Girder-Slab building design was more time effective when constructing the floor framing system. During this week the cost of the current building model was \$278,351.32 less than the Girder-Slab design because the Girder-Slab building design has more phases completed than the current building design. The Girder-Slab building design has higher percent completion during this week therefore has more expenditures to date.

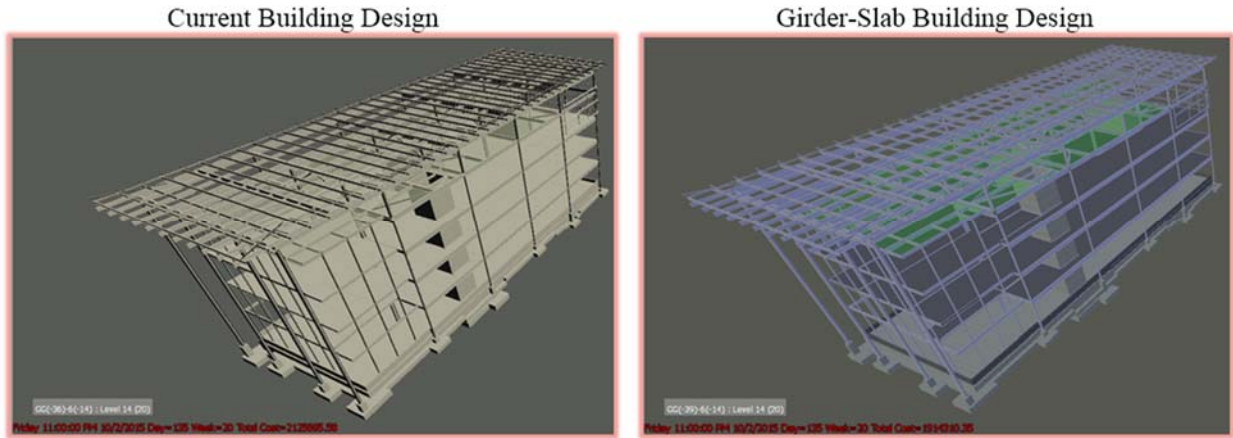

Figure 33 Current vs. Girder-Slab Building Design Week 20

The figure above represents both models at week 20. The construction of level four, the roof, and the canopy's structural steel beams, installation of slab-on-metal decking for levels two, three and four were completed. The installation of the new TPO roofing has started. The current building design during this week resulted in a total cost of \$2,125,695.58. The Girder-Slab building design model shows the completion of the canopy's structural steel beams. Also the construction of the new TPO roofing has started. The Girder-Slab design model resulted in a total cost of \$1,914,310.35 at week 20. The Girder-Slab building design was more time efficient when constructing the floor framing system, and its cost was \$211,385.23 less than the current building design model with all phases leading up to this week.

THIS SPACE HAS BEEN INTENTIONALLY LEFT BLANK

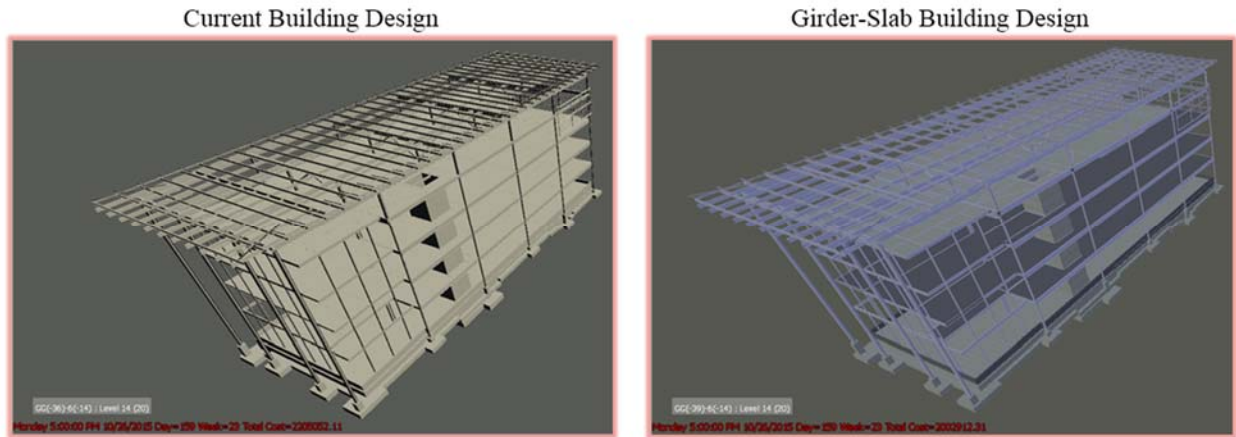

Figure 34 Current vs. Girder-Slab Building Design Week 23

The figure above represents both models at week 23 with the final end date of 10/26/15. The current building design resulted in a total cost of \$2,205,052.11. The Girder-Slab design model resulted in a total cost of \$2,002,912.31.

It was concluded that the Girder-Slab building design was more time effective when constructing the floor framing system. However, the installation of the roof resulted in the same end date for both designs because the flooring system did not affect the critical path. It was concluded that the Girder-Slab building design is also more cost effective by saving \$202,139.80 throughout the entire construction process.

For a more detailed visual representation and specifications please refer to Appendices P and Q of the BIM models for the current and Girder-Slab building designs. These models are only to be used to show a visual representation of the building, they do not contain all the details of the structural 2D drawings.

8 Project Communication Through Requests for Information.

To determine the effect of Requests for Information (RFIs) on the management process, owner's meetings were attended to identify issues with the project and to develop understanding about the communication among attending parties. Through attending these meetings and analyzing RFI data, the purpose of RFI's was investigated.

8.1 Owner's Meetings

Owner's meetings were attended every other Tuesday from September 2015 through March 2016 on the ASEC site to learn about project progress and obtain meeting minutes, a summary of the topics covered at the meeting, which contain 4-week look ahead schedules. The meeting minutes contain updates about the status of the RFI's. Often during the owner's meetings, a discussion was held about the open RFI's, which provided more detailed information than was written in the meeting minutes. This data was recorded during the meetings and used for the RFI analysis. Another source of information about RFI's is a website, Procore, used by the CM which is used for organizing and communicating all project related information to the Owner and Architect. This website specifically contains recorded information about all of the RFI's as well as the detailed project schedule. The majority of the RFI data was downloaded from this website. The major information downloaded was description of the RFI, the RFI initiated date, due date, and closed date, as shown in Table 22 below.

8.2 RFI Analysis

An analysis of 147 RFI's was carried out to determine the use of RFI's during the construction process and whether long reply times to RFI's made the construction process less

efficient. The RFI's ranged from being initiated on March 24, 2015 through January 28, 2016. The RFI data from the Procore website was downloaded into an Excel spreadsheet and then sorted by comparing the due date to the closed date of an RFI. This spreadsheet can be found in Appendix R. The focus of the analysis was on three of the ten RFI's that had the highest response delays: RFI 69, 73 and 128. These RFI's with high delays (14-29 days) were individually investigated for two factors:

1. Did the delay in response affect the scheduled date related to that task?
 - a. If so, by how many days/weeks was the task delayed?
2. Was the task in the critical path?

This information was used to determine whether RFI's make the construction process less efficient. Table 21 below shows a summary table with all of the RFI's with delays of 14-29 days. Through further analysis of the RFI's, it was determined that the column, # of days late, represented in Table 22 is sometimes longer than the delay of response. This is suspected to be caused by a lag time between receiving the response to an RFI and doing the official paperwork to close the RFI.

Table 21 RFI Sorting Format

#	Initiated At	Due Date	Subject	Closed Date	# of days late
69	7/29/2015	8/12/2015	NGrid Spec for XFMR Grounding and Pad	9/10/2015	29
17	4/8/2015	4/16/2015	Missing FA and PWR to SFDs 4th Floor Mech Well	5/15/2015	29
128	12/22/2015	12/29/2015	Electrical Rough-In Clarifications	1/26/2016	28
95	9/28/2015	10/5/2015	Electric Metering (For Record)	11/2/2015	28
79	8/17/2015	8/24/2015	Window Operators Clarification	9/18/2015	25
61	6/26/2015	7/10/2015	Cafe Grease Trap Pit Size	7/28/2015	18
4	3/24/2015	4/2/2015	W10x19 Bolted Splice at Roof Canopy Framing	4/17/2015	15
82	8/20/2015	8/27/2015	Future Canopy Loads	9/10/2015	14
73	8/6/2015	8/6/2015	Blocking out for Guardrail Sleeves	8/20/2015	14
68	7/23/2015	8/6/2015	Rebar Fix at Mat Slab for Stair #2	8/20/2015	14

Traditionally RFI's are used for documenting a request for information about an aspect of the project, often involving conflicting or missing information on the plans. However, through

analysis of the RFI process used by the CM for the ASEC, it seems that the RFI is also used as an identification method to communicate an issue that has arisen about the project.

For example, RFI number 69, shown in Table 21, deals with the transformer on the ASEC site. The Owner was originally responsible for the transformer, but during construction ownership was transferred to National Grid. As a result of this ownership change, the XFMR transformer grounding and pad had to follow the specification provided by National Grid instead of the one provided in the contract documents. The RFI for this topic is a summary of the changes directing the readers to the new specification provided by National Grid and a CCD (Change to the Contract Documents). It seems that this RFI was used as a method to officially alert everyone working on the project about the change. This task was not on the critical path so there was no delay to the schedule.

The RFI process was also studied to determine the effect of RFI turnaround on the construction process. There is a high volume of RFI's from start to finish of a construction project. It is important for those responding to the RFI to reply quickly, as it helps to prevent delays in construction. It is particularly important to get quick replies to the RFI's that deal with critical path items, as any delay to the critical path will extend the end date of the project. The table below shows a summary of how the RFI's were sorted by the delays in response. As shown there was a 29-day delay for RFI number 69 and a 14-day delay for RFI number 73.

Table 22 RFI Delay Tracking

	A	C	E	F	O	W
1	#	Initiated At	Due Date	Subject	Closed Date	# of days late
2	69	7/29/2015	8/12/2015	NGrid Spec for XFMR Grounding and Pad	9/10/2015	29
4	128	12/22/2015	12/29/2015	Electrical Rough-In Clarifications	1/26/2016	28
10	73	8/6/2015	8/6/2015	Blocking out for Guardrail Sleeves	8/20/2015	14
149						

RFI number 73 is an example of a situation in which the CM developed a design solution in a RFI to prevent a 5 week delay to the critical path. This RFI appeared to have a submittal delay of 14 days; however, it was determined through analysis that the RFI was replied to on time. The delay reflects a time lag in doing the official paperwork to close the RFI. The issue at hand was that the Miscellaneous Metals contractor required an extra five weeks to provide galvanized sleeves for a guardrail, which needs to be installed before placing concrete around it. Waiting five weeks for the guardrail sleeve would prevent building a concrete wall and backfilling. This was necessary to prepare to bring a lift onto the site used for steel detailing. The steel detailing was a critical path item so a five-week delay would have set the project schedule back. The CM developed a design solution to use a wood block the same size as the sleeves to be placed while the concrete is placed and replaced by the galvanized sleeves once they arrive on site. They requested a fast reply time for the RFI which was replied to that day. This allowed the problem to be fixed and prevented any delay to the schedule. This RFI serves as a “pro-active approach” used by the CM for the construction management process.

On the other hand, RFI number 128 is an example in which the critical path was affected. This RFI deals with a clarification to the placement of electrical rough-in in various locations throughout the building, as the electrical and architectural drawings did not correspond. Installation of the rough-ins was originally scheduled for January 8th of 2016, but the installation was pushed back because the response to the RFI didn't come until the 20th of January. The electrical rough-in is a critical path item because it needs to be completed before the drywall can be installed. As a result, the 28-day delay to closing this RFI had a major impact to the schedule.

Through analysis of the information gathered from the owner's meeting, meeting minutes, and Procore RFI data of the previous three requests for information, it seems that RFI use falls into three different categories: official communication, pro-active approach, and common use.

9 Conclusions

This project determined that using the Girder-Slab floor framing system design is a cost effective and time efficient alternative while maintaining the structural integrity of the building.

The structural capacity of the building remained the same, even though fewer beams and girders were required. Additional angle sections provided support for the precast planks along the perimeter of the building and along open areas. The new fixed connection for the exterior columns offered more support to the structure without a negative impact on the cost or schedule.

The Girder-Slab building design is more time effective when constructing the floor framing system. Both schedules have the same start date (3/12/15), but the critical path was shortened by nine days. Therefore the critical path for the Girder-Slab floor framing schedule would have ended on 9/28/15 and the current floor framing schedule ended on 10/9/15. It was concluded that the Girder-Slab building design is also more cost effective by saving \$202,139.80 throughout the entire construction process.

The RFI analysis showed that RFI's are commonly used for the purpose of requesting information about a project, but can also be used to officially document information about the project and notify all involved. The study also determined that RFI's with long response times can cause delays to the project schedule, especially for RFI's dealing with critical path items.

In this situation, through research, the Girder-Slab floor framing system design is shown to be a cost effective and time efficient alternative. However, in practice this may not always be the case due to the precise construction and installation processes required by this new type of floor framing system.

References

- 8th Edition 780 CMR Base Code MA Amendments to the IBC 2009. (2015). Retrieved 2015, from <http://www.mass.gov/eopss/consumer-prot-and-bus-lic/license-type/csl/8th-edition-base-code.html#>
- American Institute of Steel Construction, (2011). *Steel Construction Manual*: American Institute of Steel Construction.
- American Concrete Institute, ed. "ACI 318-14." *Building Code Requirements for Structural Concrete* (2014): n. pag. Print
- Ashcraft, H. W. (2008). *Building Information Modeling: A Framework for Collaboration*. *THE CONSTRUCTION LAWYER*.
- Building Code Requirements for Structural Concrete: (ACI 318-14) ; and Commentary (ACI 318R-14)*. Farmington Hills, MI: American Concrete Institute, 2014. Print.
- Civil Engineering Careers. (2015). CE Exams and Licenses. Retrieved October 2015, from <http://www.civilengineeringcareers.org/ce-exams-and-licenses>
- Condon, P. (Email, 2016). [WPI MQP Clark ASEC Question].
- Consigli Construction. (2015). Lean Project Delivery. Retrieved from <http://www.consigli.com/approach/lean-project-delivery/>
- Differences in Welds. (2009). Retrieved 2015, from <http://diy-welder.com/links.shtml>
- Ding, Y., & K.S. Madugula, M. (2004). Elastic and Plastic Section Moduli of Steel Angles About Principal Axes. *Engineering Journal, First Quarter*, 7.
- Enclos. (2010). Chapter 1. The Basis Of Architecturally Exposed Structural Steel. 2015, from http://www.enclos.com/assets/docs/Insight01-Chapter10-Architecturally_Exposed_Structural_Steel.pdf
- Fire Proofing Application - Intumescent. (2014). Retrieved October, 2015, from <http://isolatek.com/intumescent-app/>
- Fisher, D. (Email, 2015). [Managing Partner Girder-Slab Technologies].
- Halpin, D. W. (2010). *Construction management*: John Wiley & Sons.
- Mack Industries, I. Mack Planking Preinstallation FAQs. Retrieved 2015, from http://www.girder-slab.com/data/tech/17_MackFAQs.pdf
- Mackie, C. (2014). An Introduction to Lean Construction. Retrieved October 2015, from <http://www.buildingsguide.com/blog/introduction-lean-construction>
- "Minimum Design Loads for Buildings and Other Structures." *ASCE 7-05* (2000): n. pag. American Society of Civil Engineers. Web.
- National Institute of Building Sciences. (2007). National Building Information Modeling Standard. Retrieved 2015 from https://www.wbdg.org/pdfs/NBIMSv1_p1.pdf
- Navisworks, A. (2015). Navisworks: Project Review software for AEC professionals. Retrieved October 2015, from <http://www.autodesk.com/products/navisworks/overview>
- On Center Software, I. (2015). On-Screen Takeoff.
- Planning, Scheduling and Construction Management. (2014). Retrieved 2015, from <http://theconstructor.org/construction/planning-scheduling-and-construction-management/14/>
- Plotner, S.C. (2011). RS Means Concrete and Masonry Cost Data 2012; RS Means Company Incorporated.
- Popov, V., Juocevicius, V., Migilinskas, D., Ustinovichius, L., & Mikalauskas, S. (2010). The use of a virtual building design and construction model for developing an effective project concept in 5D environment. *Automation in construction*, 19(3), 357-367.
- Porter, M. L., & Ekberg Jr., C. E. (1975). *Design Recommendations for Steel Deck Floor Slabs*. Paper presented at the International Specialty Conference on Cold-Formed Steel Structures. Retrieved October 2015, from <http://scholarsmine.mst.edu/cgi/viewcontent.cgi?article=1087&context=iscs>

- Project, M. O. (2015). Project: Delivering Winning Projects. Retrieved 2015, from <https://products.office.com/en-us/Project/project-and-portfolio-management-software>
- Radosavljevic, M., Bennett, J., & Ebrary Academic, C. (2012). *Construction management strategies: a theory of construction management* (Vol. 1). Ames, Iowa;Chichester, West Sussex, UK;: Wiley-Blackwell.
- Revit, A. (2015). Revit: Building design and construction software. Retrieved 2015, from <http://www.autodesk.com/products/revit-family/overview>
- R.S. Means Company, E. (2011). 2012 Open Shop Bccd: R S Means Company.
- Sheba, P. CE1353 - Construction Planning and Scheduling. Retrieved September 2015, from <http://www.niuniv.com/NIUWeb/qbank/EVEN%20SEM/BE%20Civil/CE1353.pdf>
- Smith, D. K., & Edgar, A. (2008). Building Information Modeling (BIM). Retrieved 2015, from <http://www.wbdg.org/bim/bim.php>
- Stein, S. (2008). *Roosevelt Island Southtown Building No.5*.
- National Council of Examiners for Engineering and Surveying. (2015). Licensure. Retrieved 2015 from <http://ncees.org/licensure/>
- The Girder-Slab System LRFD Version Design Guide v3.2. (2015). Girder-Slab Technologies, LLC.

Appendices

All Appendices are electronic files that can be found in the "Appendices zip-folder."

Appendix A Final Loading Combination Results

Appendix B Final Girder-Slab Results

Appendix C Final W Shape Selection Results

Appendix D Sample Angle Section (L-shape Hand Calculations)

Appendix E Final Angle Section Selection Results

Appendix F Hand Calculations for Steel Baseplate Selection

Appendix G Foundation Cost Estimate

Appendix H Slab-On-Metal Decking Cost Estimate

Appendix I Steel Cost Estimate

Appendix J Precast Concrete Planks Cost Estimate

Appendix K Explanation of D-beam Cost

Appendix L Current Building Design Schedule

Appendix M Girder-Slab Building Design Schedule

Appendix N Current Building Design Revit Model

Appendix O Girder-Slab Building Design Revit Model

Appendix P Current Building Design BIM Model

Appendix Q Girder-Slab Building Design BIM Model

Appendix R RFI Analysis

Appendix S MQP Gantt Chart

Appendix T MQP Proposal