

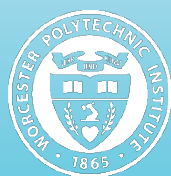

Self-Sustaining Cooling System

Major Qualifying Project



WPI

Self-Sustaining Cooling System

A Major Qualifying Report

Submitted to the Faculty of

Worcester Polytechnic Institute

In partial fulfillment of the requirements for the

Degree in Bachelor of Science for

Michael Bahnan

Mechanical Engineering Biomechanics Concentration

Kristen Bender

Mechanical Engineering Biomechanics Concentration
Professional Writing

James Mosteller

Mechanical Engineering Design Concentration

Joseph Tomellini

Mechanical Engineering

Project Number: JMS - 1802

Date: April 26, 2018

Project Advisors:

Professor John Sullivan

This report represents the work of one or more WPI undergraduate students submitted to the faculty as evidence of completion of a degree requirement. WPI routinely publishes these reports on its web site without editorial or peer review.

Table of Contents

Table of Figures	4
Table of Tables	6
Abstract	7
Executive Summary	8
Acknowledgements	10
Authorship	11
Introduction	12
Background	13
Human Factors	13
Operational Envelope	17
Materials	21
Preexisting Products and Patents	22
Products	22
Patents	24
Design Strategies	25
Functional Requirements and Design Parameters	25
Project Objectives	26
Pairwise Comparison	28
Model and Analysis of Designs	29
Phase Changing	29
Shirt Structures	30
Preliminary Pump Concepts	33
Biomechanics	33
Solar Panel Powered Pump	37
Pump Concepts	37
Pump Concepts	38
Thermal Properties	39
Methodology	46
Proof of Concept	47
Prototype	51
Prototype Iterations	53
Evaporation Frame	53

PVC Tension	53
CAD Model and Print	54
Separate System Testing.....	55
Secondary Prototype Testing.....	57
Final Prototype Testing	58
Results.....	60
No microfiber sheet test.....	60
No Breeze over Wet Microfiber Sheet Test	61
Overview of Preliminary Tests	66
Discussion.....	69
Test Protocol	69
Prototype Iterations.....	69
Tubing	69
Frame	69
Testing.....	70
Further Research.....	70
Conclusions	71
References	73
Appendices.....	77
Appendix A: Peristaltic Pump Output Data.....	77
Appendix B: Other Human Factors Information	77
Appendix C: Heat Calculations	78
Appendix D: Pairwise Objectives Total	79
Appendix E: LabView Vis	80
Appendix F: Testing Protocol	83
Appendix G: Designing Capability Statements to Win Federal Contracts MQP Continuation	85
Abstract.....	87
Acknowledgements.....	87
Purpose	87
Background	88
Government Contracting Basics.....	88
Federal Acquisition Regulation	90
Government Purchase Processes.....	90

How Businesses Enter Contracting Cycles	92
Writing Aspects of Capability Statements	94
Research Questions	95
Methodology.....	95
Genre Analysis.....	95
Usability Review.....	97
Results.....	97
Genre Analysis.....	97
Usability Review.....	101
Conclusions and Recommendations.....	104
Capability Statements Samples.....	106

Table of Figures

Figure 1: Sweat Rates Across Human Body	15
Figure 2: Overseas Deployments	17
Figure 3: Average Annual Global Temperatures.....	18
Figure 4: Average Annual Global Relative Humidity.....	19
Figure 5: Heat Index.....	20
Figure 6: TechNiche Hyperkewl	22
Figure 7: TechNiche Comp Cooler.....	23
Figure 8: TechNiche CoolPax.....	23
Figure 9: Veskimo.....	23
Figure 10: EZ CoolDown.....	24
Figure 11: Honeycomb Pattern.....	30
Figure 12: Tubing inside Shirt	31
Figure 13: Humidifier Sheet	31
Figure 14: Sample Peristaltic Pump	33
Figure 15: Uilleann Pipe Bellow	34
Figure 16: Spring Stretch.....	34
Figure 17: Sliding Weight	35
Figure 18: Centripetal Spinner	35
Figure 19: Rolling Actuator	36
Figure 20: Driving Wheel.....	36
Figure 21: Goal Zero Solar Panel.....	37
Figure 22: Psychrometric chart displaying physical and thermodynamic properties.....	46
Figure 23: Proof of Concept Experiment.....	47
Figure 24: Pumping with Water Circulation.....	48
Figure 25: Pumping Without Circulation	48
Figure 26: Proof of Concept Experiment Set-Up.....	49

Figure 27: Prototype Shirt Inside	51
Figure 28: Prototype Shirt.....	51
Figure 29: Prototype Evaporation Frame.....	51
Figure 30: Final Prototype Evaporation Section	52
Figure 31: Final Prototype Sections	52
Figure 32: Drip Well Design.....	55
Figure 33: Proof of Concept Set Up	56
Figure 34: No MicroFiber Sheet Experiment Results.....	60
Figure 35: No MicroFiber Sheet Experiment Temperature Difference	60
Figure 36: No breeze over wet microfiber sheet test.....	61
Figure 37: Wet No Breeze Test Water Temperature Difference	61
Figure 38: Cool breeze over wet microfiber sheet test	62
Figure 39: Cool breeze over wet microfiber sheet Temperature Difference	62
Figure 40: Warm breeze over wet microfiber sheet test	63
Figure 41: Warm breeze over wet microfiber temperature difference	63
Figure 42: Insulated evaporative cooling test.....	64
Figure 43: Insulated evaporative cooling temperature difference.....	64
Figure 44: Static Test.....	65
Figure 45: Static Test Temperature Difference.....	65
Figure 46: Static Full Test	67
Figure 47: Dynamic Full Test	68

Table of Tables

Table 1: DoD Height/Weight Standards.....	16
Table 2: Set Assumptions and Parameters	16
Table 3: Recommended Work Loads at Given Temperatures/Relative Humidity.....	21
Table 4: Set Assumptions and Parameters	21
Table 5: Related Patents	24
Table 6: Functional Requirements and Design Parameters.....	25
Table 7: Team Pairwise Matrix.....	28
Table 8: Team Pairwise Objectives Comparison Results	28
Table 9: Overview of Preliminary Tests	66

Abstract

The rucksack loads that military, law enforcement, and hiking enthusiasts need for their tasks can be excessive and may lead to heat exhaustion. Cooling strategies have been proposed in the past, but there are significant constraints associated with these concepts. This MQP aimed to cool the body by pumping cooled water around the upper torso absorbing the body heat into the cooling water. The closed-system of cooled water flows to the back of the rucksack where heat is exchanged to an evaporative cooling system using a separate, non-potable water system. Field tests of the unit have documented significant quantitative cooling using this process.

Executive Summary

Due to the nature of their work, military and law enforcement personnel are often required to carry heavy loads of equipment for long periods of time in extreme temperatures. Situations such as these present a high risk for heat related injuries including heat exhaustion and heat stroke, which pose direct threats to both mission accomplishment and service members' health. To combat this predicament, a cooling system which removes heat from the user's body would reduce the potential dangers while still maintaining the ability to carry out the aforementioned tasks. As many of these situations take place in remote locations with elevated temperatures, this system must function independently of external cooling or power sources such as a refrigerator or a battery. The resulting cooling device would enable the user to operate comfortably under severe conditions for an extended period of time.

In an effort to solve this problem, our team set out to design a self-sustained cooling system for law enforcement, military personnel, and hikers which is comfortable, lightweight and effective. Our design consists of a flexible polyurethane tubing system integrated in an athletic dri-fit shirt. The tubing then connects to an external evaporative cooling panel which is attached to the outermost surface of the backpack or load bearing gear. This cooling panel includes a series of copper tubes and copper panel covered by an evaporative cooling sheet, which is kept damp by a drip well positioned above and held together by a rigid plastic frame.

Water runs throughout the closed piping system, conducting heat away from the body, which is then dissipated in the evaporative cooling panel. As water evaporates from the cooling sheet, the highly conductive copper tubing dissipates the heat from the water inside the tube to the atmosphere. From there, the cool water is run back through the shirt system to cool the body and repeats the cycle. Water is moved through the system by a small peristaltic pump which is powered by a solar panel mounted on the external face of the pack. In all, this system is able to remove

heat from the body and dissipate it to the atmosphere without the use of external power or cooling sources.

The team set out to validate the fundamental concept of the device, which was to provide light to moderate cooling to the test subject. Through testing, the team was able to successfully dissipate 156 watts of heat from the cooling system and effectively cool down the test subject. Further research into homeostasis, microclimates, cardiovascular rates, caloric rates, and perspiration to evaluate the system.

Acknowledgements

This project would not have been possible without the assistance and support from an exceptional group of individuals, each of whom contributed time, insight and expertise which enabled us to execute our project. As our project consisted of countless hours of building and testing, we would like to extend our gratitude to experimentation lab manager Peter Hefti. Not only was he kind enough to allow us time and equipment to conduct our testing, but he also helped us on multiple occasions with our testing apparatus and design procedures which were paramount to our success. Additionally, we would like to recognize Professor Ahmet Can Sabuncu for his professional insight and consistently helpful suggestions with regards to our design. We would also like to extend our thanks to administrative assistant Payton Wilkins for giving our team the opportunity to present our project to prospective WPI students on multiple occasions, which improved our presentation skills and allowed us to have input from an audience who was not familiar with our project. We would also like to thank co-advisor Professor Ryan Madan for his essential feedback on the professional writing aspect of this project and fundamental insight to the correlation and implication of engineering concepts to the expert community. Last but certainly not least, we would like to extend our utmost thanks to our co-advisor Professor John Sullivan. Since agreeing to oversee our project over a year ago, Professor Sullivan has been an amazing asset for our team for which we are extremely grateful. His experience and guidance were essential to the execution of our project and it truly would not have been possible without him.

Authorship

All members of the team contributed to this project equally, from writing to editing to presenting.

Introduction

Rucksacks worn in warm environments for extended periods of time pose a health threat to military, law enforcement personnel and hikers. The weight, usability and safety of these packs are generally performance oriented, while comfort and cooling may not be addressed. Without proper cooling, individuals can quickly become uncomfortable and suffer physiological problems due to heat related injuries. Although a spectrum of portable cooling technology is already available, limited work has been done with a independently powered system cooled by an external evaporation source.

The demand for a product of this nature is demonstrated through the vast number of military and law enforcement personnel in the line of duty, paired with the physical limitations of the human body. Products on the market each have limitations, including access to a freezer or refrigerator, accompanied by excess weight and bulk. As a result, any solution to the problem must ideally be lightweight, self-sufficient, and comfortable, while still providing adequate cooling to the user.

In the military and law enforcement profession, bullet proof vests and heavy rucksacks are an integral part of safety and are necessary for mission accomplishment. This equipment is inherently heavy and adds a burden to those utilizing them. To add to the strain, the vast majority of these personnel are operating in arid environments with excessive temperatures. The combination of weight, physical exertion and extreme temperatures result in a potentially deadly formula for heat related injuries including heat exhaustion and heat stroke. Injuries such as these are a huge danger faced daily by both law enforcement and particularly military members deployed overseas and are a limiting factor in their ability to do their jobs and accomplish the mission at hand.

To combat these predicaments, the team has set out to create a system which is able to cool the operator to allow them to maintain their health and better accomplish their mission. While other products exist to help with this issue, they all require a source for cooling outside of the device such as a refrigerator, battery or readily available cool water. Given the potentially remote locations of the usage of this device, it is designed to function without the use of outside sources of power or an external cooling source. Additionally, as this product is going to be carried by people who are already heavily weighed down it must be inherently lightweight. Unlike other previous attempts to solve this problem, this product will only require a water source which is not dependent on temperature or potability. This will allow the product to cool nearly any operator in any environment to prevent the potential cause of heat related injuries. This product is designed to promote airflow comfortably, therefore optimizing its effectiveness as a cooling device.

In order to best serve our country's service men and women, this project aims to provide an effective, efficient solution to the magnanimous problem of heat related injuries which affects those who are weighed down by equipment and protection regardless of their environment. If implemented, this product could potentially provide a comprehensive and practical solution to those who are subjected to the conditions which would cause heat injuries.

Background

Human Factors

The human body is an excellent thermoregulated system that maintains a normal internal core temperature of 37°C and an average skin temperature of 33°C through homeostatic mechanisms. Although individual body temperature is affected by age, sex, exertion, and health status, internal temperature can range from 35°C to 41°C before organ systems are irrecoverably damaged beyond these limits. The average external skin temperature is 33°C, but can be as low or high as 15°C to 37.5°C depending on the environment and region of the body (i.e. extremities or

torso). The primary factor influencing skin temperature is amount of time spent in the air temperature of a specified environment. Outside of ambient environmental factors such as humidity and wind chill, the body's work rate and clothing also contribute to the body's temperature and necessary cooling requirements.

The intention of this project is focused on the upper limits of these ranges. Consequently, the team's applied body temperatures are assumed as follows:

Internal Temperature: 37°C

External Temperature: 33°C

In order to maintain homeostasis, the body will sweat to reduce core temperature and shiver to increase core temperature. By evaluating Figure 1, it is observed that the highest areas of sweat rate, exceeding 1000 g/m·hr, are located along the posterior portion of the torso along the spine, extending from the iliac crest to the scapula. There are notably high sweat rates on the forehead and remaining areas of the skull, along with the chest and shoulder region. Thus, the team will focus on cooling the entire torso, anteriorly from the chest to the abdomen, and posteriorly from the scapula to the lower back.

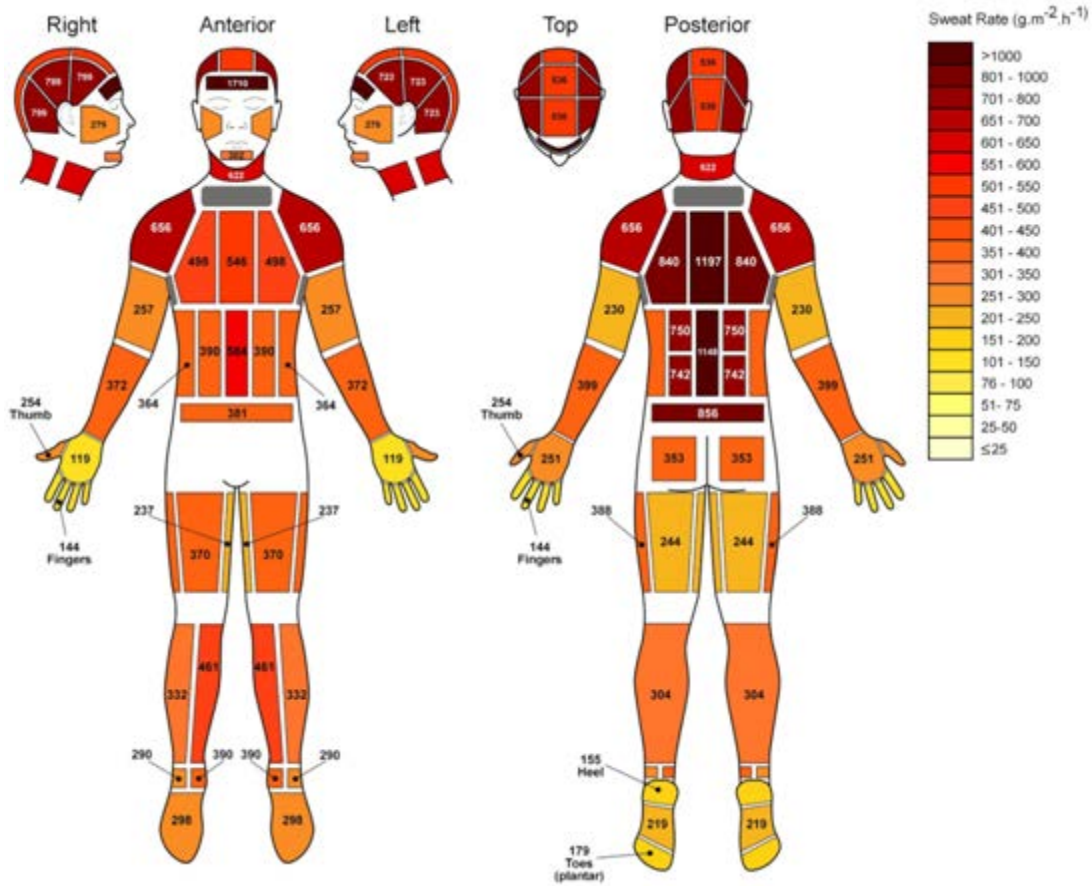

Figure 1: Sweat Rates Across Human Body

The team established a list of anthropometric assumptions to carry out all calculations and define the team’s body parameters. Given the height and weight requirements (as indicated in Table 1) for military personnel, the team identified the ranges and averages shown in Table 2 [6]. By applying the Du Bois body surface area formula ($BSA = 0.007184 \times W_{\text{m}} \times H_{\text{m}}$) to the provided assumption bounds, it was determined that the total body surface area ranged from 1.48 m² to 2.43 m² [9]. This was cross referenced and verified by the simplified Mosteller calculation for body surface area, ($BSA = 0.016667 \times W_{\text{m}} \times H_{\text{m}}$) [7]. The Rule of Nines can then be applied to determine the surface area of the anterior and posterior torso (totaling 36%), so that the range of applicable torso surface area is defined as 0.5328 m² to 0.8748 m² [23]. This range was applied for all thermal calculations.

Table 1: DoD Height/Weight Standards

DoD Height/Weight Standards Table

Males			Females		
Height	Maximum Standard	Minimum Standard	Height	Maximum Standard	Minimum Standard
(Inches)	(Pounds)	(Pounds)	(Inches)	(Pounds)	(Pounds)
56"	122	85	56"	115	85
57"	127	88	57"	120	88
58"	131	91	58"	124	91
59"	136	94	59"	129	94
60"	141	97	60"	133	97
61"	145	100	61"	137	100
62"	150	104	62"	142	104
63"	155	107	63"	146	107
64"	160	110	64"	151	110
65"	165	114	65"	156	114
66"	170	117	66"	161	117
67"	175	121	67"	166	121
68"	180	125	68"	171	125
69"	186	128	69"	176	128
70"	191	132	70"	181	132
71"	197	136	71"	186	136
72"	202	140	72"	191	140
73"	208	144	73"	197	144
74"	214	148	74"	202	148
75"	220	152	75"	208	152
76"	225	156	76"	213	156
77"	231	160	77"	219	160
78"	237	164	78"	225	164
79"	244	168	79"	230	168
80"	250	173	80"	236	173
81"	256	177	81"	242	177
82"	263	182	82"	248	182

Table 2: Set Assumptions and Parameters

Topic	Low	High	Average
Age	18	30*	25
Weight	85 lbs	263 lbs	180 lbs
Height	4'9	6'8	5'10

*for those actively involved in field training exercises

Operational Envelope

Military

Of 2.1 million military personnel, 1.3 million are actively deployed, domestically and overseas. As of March 2017, about two hundred thousand troops are deployed abroad. The countries where the most war fighters are deployed include Japan, Germany, South Korea, Italy, Afghanistan, United Kingdom, Kuwait, and Iraq, as visualized in the Figure 2. Stateside, the greatest number of personnel (in descending order) are based in California, Texas, North Carolina, Virginia, Georgia, Florida, Washington, and Hawaii. Troops in training and combat phases will often wear rucksacks containing various gear and weighing upwards of 50 pounds. This large rucksack, coupled with a bulletproof vest, generates a warmer, insulated microclimate



Figure 2: Overseas Deployments

Police

The largest domestic police departments are New York, Chicago, Los Angeles, Philadelphia and Houston, comprising a total of some 61,300 officers. Of these departments, the summer months can become hot enough to compare to overseas temperatures, coupled with more

humid climates. Police are required to wear bulletproof vests while on duty, creating an insulated microclimate as well.

Temperature

When cross-referencing the annual global temperature averages seen in Figures 3 and 4, it is evident that the mentioned personnel are operating in warmer environments ranging from 15°C to upwards of 30°C with full range of relative humidity. The team needs to take regional temperatures and required gear regulations into consideration while implementing testing procedures and project feasibility.

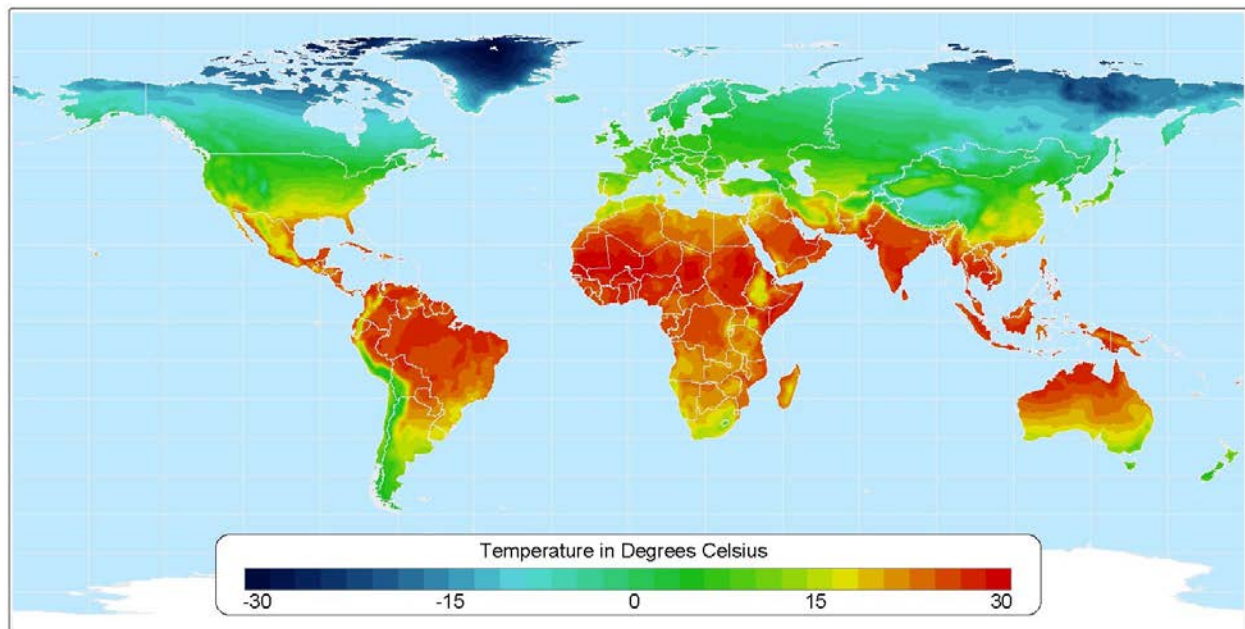

Data taken from: CRU 0.5 Degree Dataset (New, et. al.)

Atlas of the Biosphere
Center for Sustainability and the Global Environment
University of Wisconsin - Madison

Figure 3: Average Annual Global Temperatures

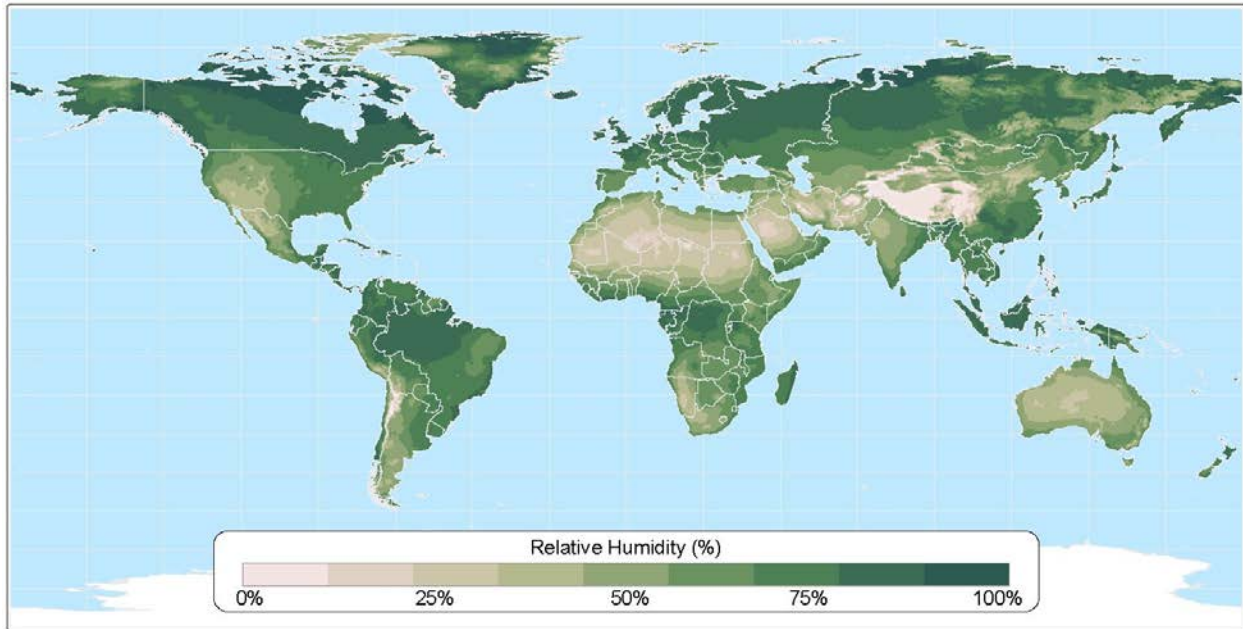

Data taken from: CRU 0.5 Degree Dataset (New, et al.)

Atlas of the Biosphere
 Center for Sustainability and the Global Environment
 University of Wisconsin - Madison

Figure 4: Average Annual Global Relative Humidity

Regulations

Heat is considered a hazard in the work environment, whether it originates from temperature, hot objects, or strenuous physical activities. When surrounding environmental temperatures begin to match and exceed body core temperature, heat related injuries begin to develop. If the body is unable to effectively cool itself through sweating and evaporation, it will hold the heat internally. Consequently, heat rash, heat cramps, heat exhaustion and heatstroke become imminent dangers. Heat rash is a skin irritation due to excessive sweating. Heat cramps involve muscle pains and spasms. Heat exhaustion precedes heat stroke and includes symptoms like dizziness, excessive sweating, vomiting, weak pulse and muscle cramps. Heat stroke is the most severe with headaches, vomiting, no sweating, rapid pulse, confusion, and fainting. Heat stroke is a life-threatening emergency that can lead to death [United States Department of Labor, 2016].

In the areas with the highest concentrations of military and police personnel, the temperature ranges from -3°C to 43°C with a relative humidity from 0 to 87% [NOAA, 2017]. As seen in Table 3, dangerous heat indexes are quickly reached as increased temperature and relative humidity percentages combine. Values from 90-104 are usually the range in which heat cramps or heat exhaustion is possible. From values 105-130, heat cramps and heat exhaustion are likely and heat stroke is a possible risk. At values exceeding 130, heat stroke is highly likely. In Table 4 below, the US Department of Labor has recommended certain operational recommendations for given conditions to ensure worker safety.

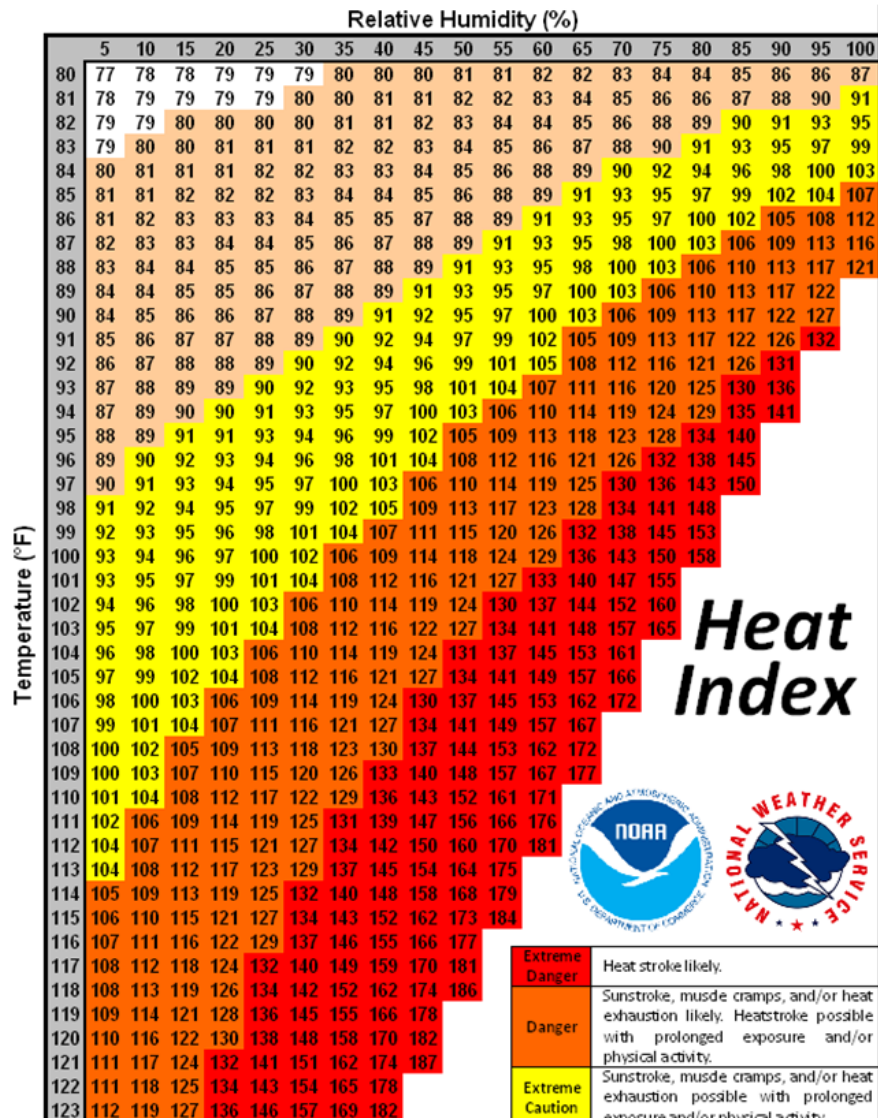

Figure 5: Heat Index

Table 3: Recommended Work Loads at Given Temperatures/Relative Humidity

Maximum recommended work load					
Temperature		Relative Humidity (%)			
°F	°C	30	40	60	80
80	27	Very Heavy	Very Heavy	Very Heavy	Heavy
90	32	Very Heavy	Heavy	Moderate	Light
100	38	Heavy	Moderate	Light	Not recommended
110	43	Moderate	Light	Not recommended	Not recommended
120	49	Light	Not recommended	Not recommended	Not recommended

Utilizing the Microclimate Cooling and Power Requirement study from the US Army Soldier Systems Center in Natick, Massachusetts, the team identified average metabolic heat production for standard work tasks, as seen in the table below. Their study determined that military personnel require between 600-1200 watt-hours of cooling per day. A cooling rate of 300 watts per day sufficiently reduced heat stress and “enhanced performance under a variety of environmental conditions, protective gear and work rates”. Lower cooling rates of 100-200 watts also gave relief from heat stress at a diminished level.

Table 4: Set Assumptions and Parameters

Activity Level	Metabolic Heat Production	Example Activity
Light	100-175 watts	Standing duty
Moderate	125-325 watts	Cleaning
Heavy	325-500 watts	Skills Training
Very Heavy	500+ watts	Combat Training

Materials

For the completed product, the team must find materials which allow the system to be lightweight, breathable, and effective at cooling the body. Additionally, the tubing system must also meet these guidelines by being flexible, durable and watertight.

To achieve the lightweight and breathable shirt system, a synthetic fabric such as nylon or polyester could be used, however more advanced materials such as Lycra, dri-fit or a blend is likely to be the most effective. These materials allow for the user to release heat and wick sweat away from their body, preventing the tubing system from creating excess heat for the user by trapping it inside.

While tubing cannot be breathable due to its required properties, it is still necessary that it be lightweight and flexible. Polyurethane, silicone, latex, PVC and other medical grade tubing each offer varying levels of these properties. Further testing will prove which materials provide optimal flexibility to allow for the tubing to contour to the user's body in order to maximize comfort.

Preexisting Products and Patents

Many specialty industries have benefited from the innovation and production of cooling systems in a variety of circumstances. Often created as vests to keep the user cool in situations where other cooling options are either unavailable or impractical, these vests serve as a baseline to show the current industry standard, as well as the flaws.

Products

TechNiche

Innovators at TechNiche technologies developed the Hyperkewl line of products as a solution with a large variety of uses including motorsports, industry and military, among others. The vest is first soaked in water, then wrung out and worn over clothing. Hyperkewl uses advanced materials to retain the water inside the vest, allowing for it to slowly evaporate, providing cooling to the user.



Figure 6: TechNiche Hyperkewl

In addition to their Hyperkewl line, TechNiche also offers a product called the Comp Cooler. This system is an integrated vest pump system, similar to a personal hydration pack. Rather than providing drinking water to the user, this pack uses a pump to push water throughout the tubes that line the vest, cooling down the user.



Figure 7: TechNiche Comp Cooler



Figure 8: TechNiche CoolPax

Along with their water-cooled technologies, TechNiche developed a third

line of products called CoolPax. CoolPax uses phase change technology to cool the wearer. Similar to a very large icepack, CoolPax requires the user to “freeze” the vest, which has a freezing point of 14°C. The vest then remains

cool for up to three hours as the solid slowly transitions to a liquid.

Veskimo

Veskimo cooling systems are also designed to provide cooling to a variety of occupations, namely motorsports, aviation and emergency workers. The Veskimo is a lightweight breathable mesh vest which houses over 50 feet of tubing throughout the front and back of the vest. This tubing is connected to a larger pipe, which attaches to a small cooler. This cooler contains cold water, a power source and a pump, and circulates the cool water through the vest to initiate the cooling process.



Figure 9: Veskimo

EZ CoolDown

Another phase change material, EZ CoolDown is designed for a multitude of uses and is fairly slim in design. The material allows the user to wear it directly on their skin, but it operates very similarly to that of the TechNiche phase change vest, just with removable inserts.



Figure 10: EZ CoolDown

Patents

In addition to the products mentioned above, further patent research was conducted to compare and contrast the current designs on the market. This research revealed three patents each of which overlapped the product in question. The first patent, US 96355889 B1 has a very similar target user including military and first responders, along with a similarly designed system. While it has a similar tubing design, this product lacks an evaporation system which is replaced by moisture wicking material that requires the user to wring the water out of the system.

In the second patent, US 6979382 B2, the product is essentially a heated shirt powered by electricity. The shirt does present temperature properties, but it fails to be self-sustaining, mobile and non-restrictive in nature. In the final patent, US 20160331047 A1, the technology for the shirt itself is extremely promising, but the shirt is just that. It shields against climate conditions through the use of different fabrics, but it contains no liquid flow, evaporation or consistent cooling.

Table 5: Related Patents

Patent No.	Description	Target User
US 96355889 B1	Cooling vest garment with channeled layer	Military, First Responders, Firefighters, Construction
US 6979382 B2	Apparatus for body heating and cooling garments	Astronauts, military
US 20160331047 A1	Layered breathable sport garment	Cyclers

Design Strategies

To combat these predicaments, the team has set out to create a self-sustained system which is able to cool the operator to allow them to maintain their health and better accomplish their mission.

Functional Requirements and Design Parameters

Table 6: Functional Requirements and Design Parameters

	Specifications	Design	Intentions/Reasoning	Notes
Comfort	Size of Shirt	US Unisex Size Small-Large	Unisex design to decrease cost, focus on tubing design	Want to limit restriction of movement and constriction of body
	Size of Evaporative Cooler	< 10" x 14" x 1.5"	To fix onto back of rucksack	
	Weight	< 5 lbs	Minimize added load to pack while still cooling the body	
	Shirt System	Dri-Fit shirt containing flexible rubber tubing	The shirt must conform to the body and must be breathable and lightweight. The tubing must be flexible to stay close to the body to transfer heat.	
	Integratable	Attaches easily to MOLLE and other universal attachment systems	Attachments on the back of the cooling panel as well as the solar panel are in place to allow for them to be quickly and easily mounted to the pack	
Functionality	Pump	Peristaltic 9-18V Pump	Lightweight and simple design of pump which can run on varied voltages	
		100 mL/min flow rate	Promote adequate convection	
	Ease of Use	Personal power settings	Ensure user can adjust the system's flow depending on environment	
Heat Transfer	Intended User	Military, law enforcement, hikers	Goal is simple design which is easy to use and highly effective	Want to have a system that successfully cools
	Power	150 Watts of heat transfer from system	Goal is to provide heat transfer similar to light to moderate metabolic heat production	
Reliability	Working Fluid	Safety	Non-hazardous fluid with favorable fluid properties and a moderate heat transfer coefficient	Want a consistent system that can be used under varying circumstances
		Potable	Any stored potable water can be used in emergency scenarios	

		Non-Potable	Evaporative cooling water is not required to be potable	
		Temperature	Non-hazardous fluid with large heat transfer coefficient	
Aesthetics	Shirt	Athletic Fit	Able to be implemented with military colors	
	Evaporative Panel	Well Defined	Clean lines, smooth edges, simplistic self-contained design	
Cost Effectiveness	Budget	Use less than \$1000 prototype budget	\$250 per each of four group members	

Project Objectives

In order to define the project direction and goal outcomes, the team described a set of design objectives and utilized a pairwise comparison test to determine the level of importance and guide team focus points. These objectives maintain the scope and intention of the project while the major objectives are as follows.

Aesthetics

The most superficial and non-technical objective involves the overall physical appearance of the system and integration between systems. Since the target user will be in uniform, it is necessary to consider the assimilation of new equipment into pre-existing systems.

Cost Effectiveness

By properly using a budget tracker and cost estimation, the team can determine basic costs for prototype generation and the life cycle of the project. With considerations to a production line process, the team can project costs for an outsourced final design. Initial costs for the project are expected to be significantly higher than production costs due to test procedures and small build parameters. Considering these factors, the design does not feature any extravagant or overtly expensive materials, which should allow for a reasonable cost in production.

Ease of Use

This objective highlights the user's interaction with working the system. The team wants to ensure that the user can put on and maintain continued use of the system, even if a part were to

break. The device should have simple repair instructions and require fewer than five steps for the user to understand how to put it on and take it off. While the operation of the unit is self-sustained, it still requires a level of user interactions. As a result, the standard operating procedure for the device should be streamlined and simplified to prevent operator error.

Efficiency

System efficiency references the rate of heat loss of the system and if the device as a whole proficiently cools the user within desired testing parameters and does not extensively waste energy due to unproductive outputs, like friction. The system must remove a sufficient amount of heat from the user's body to validate its usage as an effective method of cooling.

Flexibility

In this device, flexibility will refer to the possible changes and adjustments to the system. This includes the potential of using non-potable water, such as gray water, to filter through the cooling system. There is no need for the water running used in the system to be potable and keeping the system adaptable gives the user more options in unforgiving scenarios.

Functionality

The functionality evaluates if the system actually works as anticipated and effectively cools the user to a point where he or she can perceive an actual temperature difference and chilling effect. Functionality also pertains to the reliability of the product as a cooling method. If the product is unable to cool the user it will be completely ineffective and simply add weight.

Practicality

This objective is a realistic check to evaluate if the device can be used in normal environmental conditions and activity levels. As the purpose for the product is to assist those in combat-oriented roles, it must be practical and applicable to those given situations. If the system is able to provide cooling in a room temperature environment, but not in an arid climate, then it will be proven to be impractical for our goals.

Safety

In nearly every situation, safety is of the highest concern. This product must be created so that it does not hinder the performance of the user. More importantly, it cannot pose a risk to the wearer's health or wellbeing in any shape or form. The device should be durable enough to withstand daily wear in hot, arid conditions and should not pose an additional inconvenience.

Weight

This objective was a relative linear concept of the amount of weight being added to the user. The target user will already be carrying upwards of fifty pounds on his or her back and the team does not want to add excess cumbersome weight that may limit the user or generate fatigue at a quicker rate. The target weight for this system is to be less than five pounds.

Pairwise Comparison

Table 7: Team Pairwise Matrix

Objectives	Jimmy	Joe	Kristen	Mike	Totals
Aesthetics	0	0	0	1	1
Comfort	2	2	1.5	1.5	7
Efficiency	3	3	4.5	3	13.5
Functionality	4	5	4.5	3.5	17
Reliable	4.5	4	4	3	15.5
Weight	2.5	1	3	3	9.5

Table 8: Team Pairwise Objectives Comparison Results

Most Important Objectives Top to Bottom
Functionality
Reliable
Efficiency
Weight
Comfort
Aesthetics

From these design objectives, in conjunction with testing parameters, the team created a list of measurable design specifications that correlate to specific objectives. These specific objectives are staples of the project and are a firm requirement for the prototype regardless of design. The system must provide noticeable cooling without the use of hazardous materials and effectively prevent heat related injuries. In addition, the system must be lightweight and flexible, not restrict movement for the user and the evaporation system must be able to fit the rucksack.

From a design perspective, the team decided to create requirements that charter the design in a direction that would separate our product from the current products on the market. The system would be exceptional from the current market by creating a self-sustaining, reliable, cooling system that would cool a large surface area of the body at an effective rate. Because this system would be placed in environments with extremely warm and cool climates, the system must be able to withstand these conditions.

Model and Analysis of Designs

Phase Changing

As the team set out to brainstorm design concepts for the system, the team established a list of possible solutions to fabricate the product. The team first suggested to incorporate the concept of phase changing to effectively keep the water cool for long durations of time. The idea of a phase changing bottle warmer sparked the interest for this route due to the length of time that a bottle warmer remains at high temperatures. The team set out to find a way to possibly phase change from a liquid to a solid but instead of a hot solid, a cool solid that would gradually climb to the temperature of the surrounding air. It was later determined that this concept would not be effective for our project since it would require outside sources of cooling and the high operating temperature of the environment. There are a handful of companies which manufacture phase change cooling vests, however these products require that the vest be placed in a refrigerator or

similar device to change the phase from a liquid to a solid. As such, this concept would not satisfy our goal of creating a truly self-sustained cooling device. Alternatively, the team opted to utilize water as the primary cooling liquid to circulate in both systems. The team wanted to ensure that the system considered realistic conditions and could operate with non-potable water.

Shirt Structures

Valves

Based on the calculations derived by the team, it was determined that the flow required for the system and various positioning would mean that the flow needs to be regulated in one direction. The one-way check valve was implemented in early testing of the system, but the team moved away from such a design because the valves restricted the flow of water and manufacturing the valve into the system meant removing that length of tube from the overall design. The valves would also add friction that the system cannot afford to have given the parameters needed to run the pump efficiently. Overcoming that friction wouldn't be possible because it surpasses the capabilities of the pump. Alternatively, the team decided to use a completely open system that would allow fluid to flow freely and not restrict flow rate as directed by the peristaltic pump.

Honey Comb

Next, the team had to consider the design for the shirt system. The idea of a honeycomb webbing is ideal due to the structure that maximizes usable surface area while also promoting breathability. In the end, the honeycomb structure lost its favorable edge to other designs simply because of its feasibility. Each individual honeycomb would have to uniformly allow flow through open slots, while also overcoming the friction loss from the hexagonal shape of the comb.

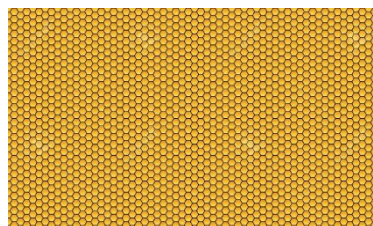

Figure 11: Honeycomb Pattern

Tubing

Maximizing cooling while also flowing water to all parts of the upper body lead the team to a concept of wrapping the tubing around the entire upper body and having one continuous system flowing water. At the surface, having this design would mean that the team would maximize the surface area and reach every square inch of the torso. But as further analysis was conducted,

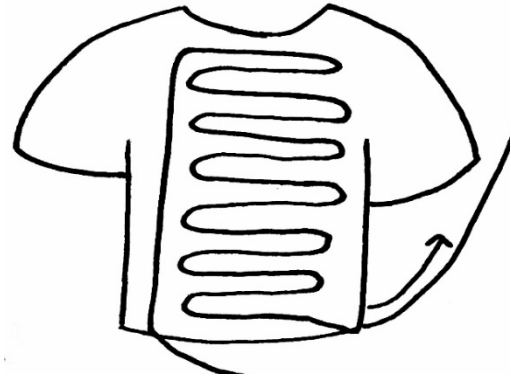

Figure 12: Tubing inside Shirt

the concept was not ideal because of the user's need. Addressing the user's need is always the priority of the project and if it does not meet those needs, the idea was consequently disposed of. Having tubing that wraps around the entire body would mean there will certainly be restriction in the movement of the user, which would lead to a highly uncomfortable and irritated warfighter. As such, the team opted to expand the space between the tubing and instead of wrapping continuously around the body, would be composed of a back and forth pattern, beginning at the top of the back before travelling to the top of the front of the shirt.

Evaporative Cooling Structures

Humidifier Sheet

Dissipating heat from the system is dependent on the ability of the sheet to properly absorb and efficiently evaporate the water flowing to this portion of the system. For this reason, the team researched different humidifier sheets to measure the ability of each sheet to evaporate water from the sheet to the air. The team first used a humidifier sheet made of paper. The sheet was used in early testing but proved to ineffectively evaporate water and would not withstand durability testing. Because the sheets are designed to provide



Figure 13: Humidifier Sheet

airflow when the fan inside of a humidifier is blowing air through it, the sheet did not absorb as much water as the team believed it would. In addition, the sheet's bulky design did not properly fit the frame.

Fabric Sheets

An alternative for the humidifier sheet was a microfiber cloth. Microfiber is able to absorb and retain more water while allowing water evaporation to take place. This material is also much more durable than the humidifier sheet. It can be removed and cleaned easily by hand. The spacing in the humidifier sheet is inadequately in contact with the evaporation system piping, which allows heat loss to release to the air as opposed to cooling the system's pipes. The microfiber cloth, particularly when wet would "stick" closer to the piping and can conform to the tubing for greater surface area, thus greater heat transfer.

Tubing for Evaporation Frame

The design concept behind the evaporative frame required the research of a material that would properly conduct heat while providing rigidity for structural strength. This led the team in the direction of metals, specifically copper due to its mechanical properties, which promoted its potential for implementation into our product. As such, copper tubing was used within the evaporative cooling frame to carry water through the frame allowing for it to be cooled by the microfiber cloth.

In order to maximize the surface area of copper to be cooled by the evaporative cooling sheet, a copper plate was attached to the front of the pipes. This allows the maximum contact surface from the evaporative cooling sheet to the copper tubes resulting in increased cooling as compared to the copper pipes alone.

Preliminary Pump Concepts

Biomechanics

The design objective of a self-sustaining pump to power the cooling system crucially defines the nature of our products competitiveness in the market and provides the functional difference comparatively to other products on the market. For this reason, the team decided that we must develop and integrate a biomechanically powered

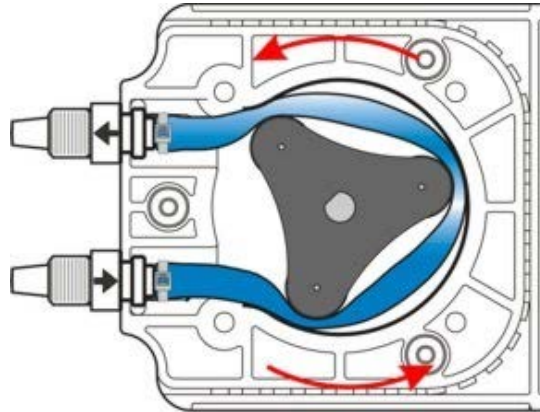

Figure 14: Sample Peristaltic Pump

pump to move water through the cooling system in the shirt to copper tubing. For testing purposes, the team has been using a ZJchao Peristaltic Liquid pump, which has a flow rate of 100-200 mL/min using a power source set at 12V. Depending on testing results for effective cooling flow rates using the DC powered peristaltic pump, the team will determine a range of attainable flow rates for the biomechanically powered pump.

The team has determined that a peristaltic pump will be the most effective mechanism to move water through the system. This design involves a rolling compression action to push tube contents through a length. Using a peristaltic pump eliminates any outside contact and contamination of the cooled water. Additionally, keeping the system closed reduces the odds of a pressure drop that would occur if the team implemented an open system with an exchange point between the cooling tube and the pump. The open system would release too much pressure for the pump to be efficiency and effective.

The mechanism for moving the cooled water is determined, but the pump requires a power source to actually rotate the compressive roller. This source of power will be biomechanically generated. The team developed seven possible design concepts, elaborated on below [31].

Uilleann Pipes

Uilleann pipes, often used in Irish instruments, these unique pipes are inflated using a set of bellows that pushes air through sets of varying pipes. The important mechanism in these instruments are the bellows, which generate pressure by pumping the upper arm against an individual's side with the bellow in between. Depending on the capacity and pumping frequency, the circulation rate of fluid in a closed system can be regulated [31].

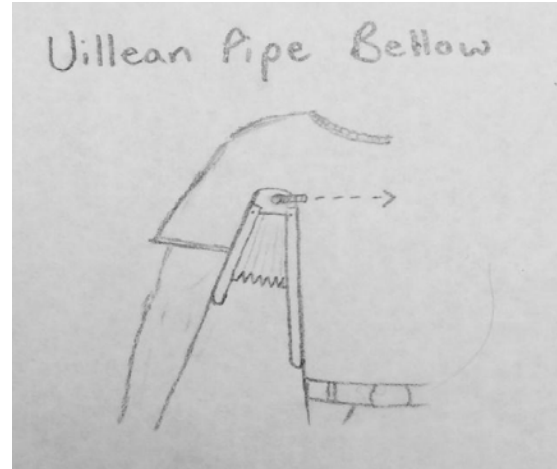

Figure 15: Uilleann Pipe Bellow

Spring Stretch

Spring stretch is a mechanism that generates pressure by the use of conventional leg motion, specifically when the leg is flexing and unflexing at the knee. When the knee is flexed, the spring is compressed and alternatively, when it is unflexed the spring expands. The constant motion of walking or running, causes the spring to build up mechanical energy. This mechanical energy, in the case of the exoskeleton, takes the load off the individual's back and makes travelling with a heavy backpack relatively easy [25]

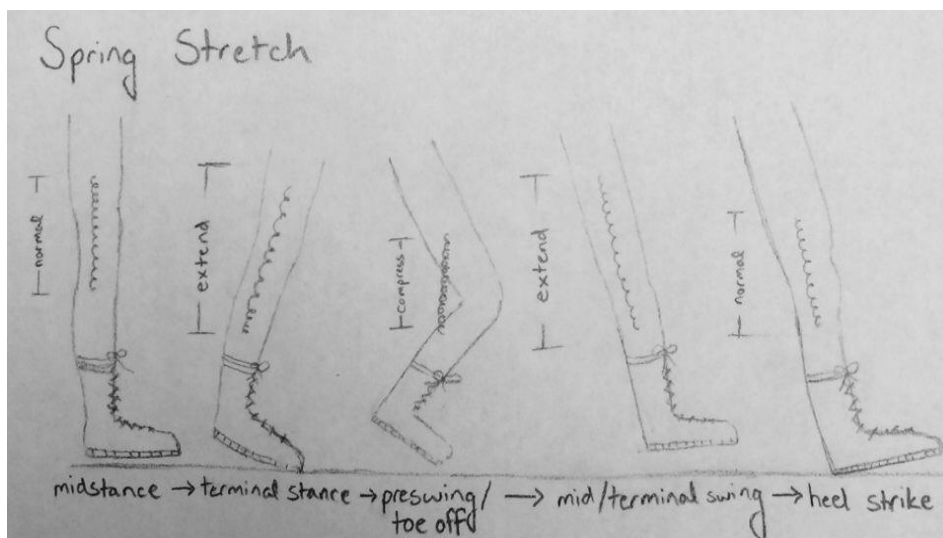

Figure 16: Spring Stretch

Sliding Weight

Often times in mechanisms a weight is used to cause a pumping action so that pressure is apply to move through a pipe or other system. The weight is restricted in that the weight has only a set degree of freedom to move along. This allows the weight to remain in relatively the same place and only moving side to side or up and down within a few inches. This becomes particularly useful when submerged in a fluid within a



Figure 17: Sliding Weight

closed system because the movement of the weight causes a buildup of pressure which is thrust in the direction the weight is moving.

Centripetal Spinner

This drive mechanism is inspired by a salad spinner, where a user can compress a handle, which releases the spinner from its tracks and allows the spinner to spin with a large amount of kinetic energy. The potential energy stored in this is large due to the centrifuge motion stored in the pump of the spinner. When the salad spinner is at rest, the pump is secured in by tracks and when the pump is pushed down on, it is released from the tracks and the basket spins. Rather than spinning a bowl in the salad spinner design, this adapted mechanism is powered by the user that provide the rotational power to the

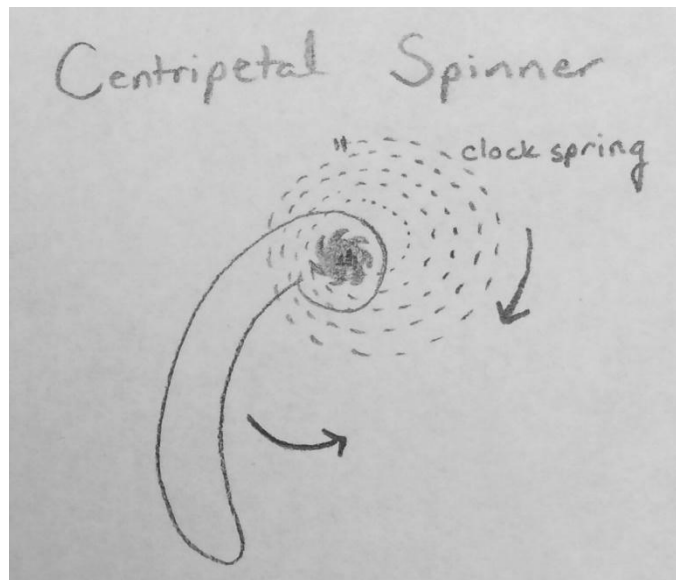

Figure 18: Centripetal Spinner

peristaltic pump. The purpose of this particular design is to convert linear motion of the body into rotational motion of the pump [4].

Rolling Actuator

A simple and yet effective design concept that is often used in applications that require a rope like structure to have constant momentum. These actuators convert the rotary motion of a shaft into linear motion at a variable pitch. Rolling ring actuators are typically used to reduce

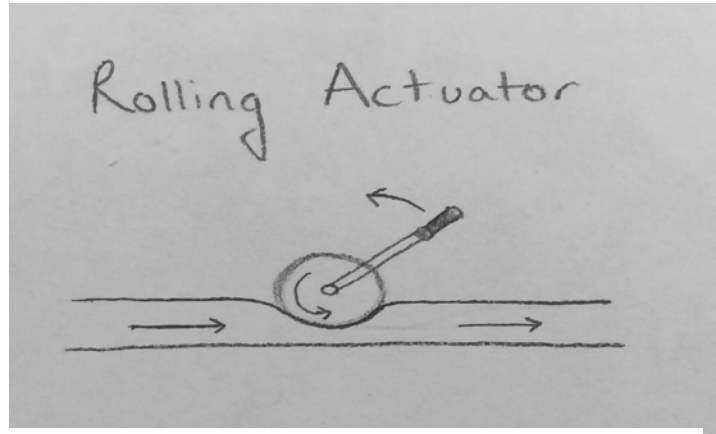

Figure 19: Rolling Actuator

the systems dependence on electronic controls, gears and other mechanisms [34].

Driving Wheel

This mechanism uses a combination of levers to rotate circular disks, which is ideal for the movement of trains. This design concept is also used in numerous applications due to its ability to use perpendicular levers to move the circular disks horizontally. As one lever moves, it

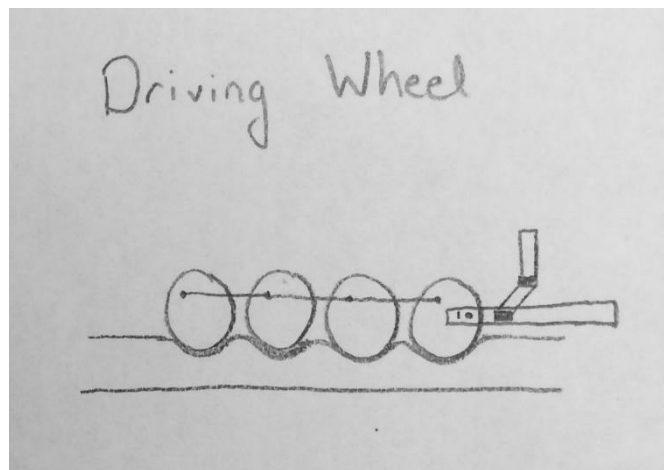

Figure 20: Driving Wheel

triggers another lever at a different angle to move and the combinational movement of those two levers allows a third lever to move in a circular direction while it is pinned to a disk [33].

Solar Panel Powered Pump

Aside from the biomechanical pump concepts developed, the team decided that ideas pertaining to other engineering concepts would provide an alternate and possibly more feasible route to power the peristaltic pump. After brainstorming possible concepts, the team elected to explore the possibility implementing a solar panel to power the pump. The peristaltic pump that has been used to conduct the experiments requires 12 V and 0.300 A to effectively flow water through the system. Because of the needs



Figure 21: Goal Zero Solar Panel

of the pump, the idea of a solar panel to harness the energy of the sun seems quite possible, primarily due to the conditions that warfighters are constantly in. For the requirement of the pump, the team conducted an in depth research about current panels and determined that the Goal Zero Nomad 14 Plus Solar Panel met the necessary needs to power the pump. The solar panel provides up to 22V of power, which would allow an increase in flow rate and thus improve the cooling system.

Pump Concepts

After exploring and testing the concepts above, the team came to the conclusion that the solar panel route was the most efficient, feasible and functionally sound concept for the constraints of our product. The biomechanical pump concepts were all promising and all provided the potential for an innovating, revolutionary design, but the feasibility behind these pumps are highly questionable. The concepts are well thought out in theory, but required an uncomfortable, repetitive motion that the user will eventually grow tired of. In reference to the uilleann pipes, the

feasibility is there, but in respect to the user, they will quickly grow tired of the constant pumping of the arm. And in that sense, the spring stretch and the sliding weight were feasible as well, but the user will quickly become uncomfortable and restrictive, which violated our design constraints. The centripetal spinner, rolling actuators and driving wheel concepts were all that in other engineering settings would work, but implementing them into the vest would not be comfortable for the user and mechanically it would not consistently pump water throughout the vest without the user pressing down centripetal spinner or pumping a lever for the spinner and rolling actuators.

From the lack of feasibility from the concepts above, came the realization that a simple solar panel to harness the sun's energy would provide our system the necessary flow and dynamic to effectively run our system. The solar panel meets our design constraints and always the pump to run at full power and without restrictions. The solar panel, because of its sleek design, the panel can attach to the ruck and not cause any restriction to the warfighter, while also harnessing energy at the highest point on the ruck and in turn giving the panel the most ideal line of sight to the sun.

Pump Concepts

After exploring and testing the concepts above, the team came to the conclusion that the solar panel route was the most efficient, feasible and functionally sound concept for the constraints of our product. The biomechanical pump concepts were all promising and all provided the potential for an innovating, revolutionary design, but the feasibility behind these pumps are highly questionable. The concepts are well thought out in theory, but required an uncomfortable, repetitive motion that the user will eventually grow tired of. In reference to the uilleann pipes, the feasibility is there, but in respect to the user, they will quickly grow tired of the constant pumping of the arm. And in that sense, the spring stretch and the sliding weight were feasible as well, but the user will quickly become uncomfortable and restrictive, which violated our design constraints. The centripetal spinner, rolling actuators and driving wheel concepts were all that in other

engineering settings would work, but implementing them into the vest would not be comfortable for the user and mechanically it would not consistently pump water throughout the vest without the user pressing down centripetal spinner or pumping a lever for the spinner and rolling actuators.

From the lack of feasibility from the concepts above, came the realization that a simple solar panel to harness the sun's energy would provide our system the necessary flow and dynamic to effectively run our system. The solar panel meets our design constraints and always the pump to run at full power and without restrictions. The solar panel, because of its sleek design, the panel can attach to the ruck and not cause any restriction to the warfighter, while also harnessing energy at the highest point on the ruck and in turn giving the panel the most ideal line of sight to the sun.

Thermal Properties

When a rucksack is worn, it acts as an insulator that encompasses the majority of the user's back. In order to compute these necessary calculations, the team elected that the system should be broken down into two separate subsystems. The team decided that the first system would be the shirt on the human torso while the second system would be the evaporative section located on the rucksack.

The first system would calculate the conduction from the human body to the outer surface of the shirt. The outer surface of the shirt makes direct contact with the rucksack, which insulates the heat from the system. By implementing the conduction equation $q = ((kA(T_1 - T_2))/L)$, the heat transfer rate of the first system is 45.995 Watts, which is shown on the following pages.

Conduction from Human Body through Skin

$$A = (lw) = (.32\text{m} * .43\text{m}) = 0.137 \text{ m}^2$$

$$k = 0.3 \text{ W/m.K}$$

$$L = 0.002 \text{ m}$$

$$T_{\text{in}} = 34\text{C} = 307\text{K}$$

$$T_{\text{out}} = 32.5\text{C} = 305.5\text{K}$$

$$q = ((kA(T_{\text{in}} - T_{\text{out}}))/L) = ((0.3 \text{ W/m.K})(307\text{K} - 305.5\text{K})(0.137 \text{ m}^2))/(0.002\text{m}) = \mathbf{30.825 \text{ W}}$$

Conduction from skin of back through shirt

$$A = (lw) = (.32\text{m} * .43\text{m}) = 0.137 \text{ m}^2$$

$$k = 0.05 \text{ W/m.K}$$

$$L = 0.000381 \text{ m}$$

$$T_{\text{in}} = 32.5\text{C} = 305.5\text{K}$$

$$T_{\text{out}} = 32\text{C} = 305\text{K}$$

$$q = ((kA(T_{\text{in}} - T_{\text{out}}))/L) = ((0.05 \text{ W/m.K})(305.5\text{K} - 305\text{K})(0.137 \text{ m}^2))/(0.000381\text{m}) = \mathbf{8.99 \text{ W}}$$

Conduction from shirt through tube

$$A = (lw) = (.32\text{m} \cdot .43\text{m}) = 0.137 \text{ m}^2$$

$$k = 0.05 \text{ W/m.K}$$

$$L = 0.004064 \text{ m}$$

$$T_{\text{shirt}} = 32\text{C} = 305\text{K}$$

$$T_{\text{tube}} = 25\text{C} = 298\text{K}$$

$$q = ((kA(T_{\text{shirt}} - T_{\text{tube}}))/L) = ((0.05 \text{ W/m.K})(305\text{K} - 298\text{K})(0.137 \text{ m}^2))/(0.004064\text{m}) = \mathbf{11.799 \text{ W}}$$

Conduction from tube through water

$$A = (lw) = (.32\text{m} \cdot .43\text{m}) = 0.137 \text{ m}^2$$

$$k = 0.02 \text{ W/m.K}$$

$$L = 0.003302 \text{ m}$$

$$T_{\text{water}} = 25\text{C} = 298\text{K}$$

$$T_{\text{tube}} = 30\text{C} = 303\text{K}$$

$$q = ((kA(T_{\text{water}} - T_{\text{tube}}))/L) = ((0.02 \text{ W/m.K})(298\text{K} - 303\text{K})(0.137 \text{ m}^2))/(0.003302\text{m}) = \mathbf{-3.37 \text{ W}}$$

Conduction from water through tube

$$A = (lw) = (.32\text{m} \cdot .43\text{m}) = 0.137 \text{ m}^2$$

$$k = 0.6 \text{ W/m.K}$$

$$L = 0.004064 \text{ m}$$

$$T_{\text{water}} = 30\text{C} = 303\text{K}$$

$$T_{\text{tube}} = 31\text{C} = 304\text{K}$$

$$q = ((kA(T_{\text{water}} - T_{\text{tube}}))/L) = ((0.6 \text{ W/m.K})(303\text{K} - 304\text{K})(0.137 \text{ m}^2))/(0.004064\text{m}) = \mathbf{-20.226 \text{ W}}$$

Conduction from tube through shirt

$$A = (lw) = (.32\text{m} \cdot .43\text{m}) = 0.137 \text{ m}^2$$

$$k = 0.05 \text{ W/m.K}$$

$$L = 0.000381\text{m}$$

$$T_{\text{water}} = 31\text{C} = 304\text{K}$$

$$T_{\text{shirt}} = 32\text{C} = 305\text{K}$$

$$q = ((kA(T_{\text{water}} - T_{\text{shirt}}))/L) = ((0.05 \text{ W/m.K})(304\text{K} - 305\text{K})(0.137 \text{ m}^2))/(0.000381\text{m}) = \mathbf{17.979 \text{ W}}$$

System 1 (Human Body to Rucksack): 30.825W + 8.99W + 11.799W + (-3.37W)

$$\mathbf{+ (-20.226W) + 17.979W = 45.995 \text{ Watts}}$$

In regards to the second system, the team calculated the conduction from the water in the copper tubing to the surrounding air. The evaporative sheet makes direct contact with the surrounding air, which will evaporate the water added to the sheet. By implementing the convection equation $q = (hA(T_s - T_a))$, the heat transfer rate of the second system is 109.655 Watts, which is shown below.

Convection from water through copper tube

$$R = 6.5024 \times 10^{-2} \text{ m}; r = 4.4958 \times 10^{-2} \text{ m}; h = 2.0907 \text{ m}$$

$$SA = 2\pi rh + 2\pi R^2 + 2(\pi Rr) = 0.14461 \text{ m}^2$$

$$h = 100 \text{ W/m}^2\cdot\text{K}$$

$$T_{\text{water}} = 31\text{C} = 304\text{K}$$

$$T_{\text{air}} = 24\text{C} = 297\text{K}$$

$$q = (hA(T_{\text{water}} - T_{\text{air}})) = ((100 \text{ W/m}^2\cdot\text{K})(0.14461 \text{ m}^2)(304\text{K} - 297\text{K})) = \mathbf{101.227\text{W}}$$

Conduction from copper through dryer sheet

$$A = (lw) = (.29\text{m} \times .23\text{m}) = 0.071 \text{ m}^2$$

$$k = 0.05 \text{ W/m}\cdot\text{K}$$

$$L = 0.021844\text{m}$$

$$T_{\text{copper}} = 24\text{C} = 297\text{K}$$

$$T_{\text{dryer sheet}} = 23\text{C} = 296\text{K}$$

$$q = ((kA(T_{\text{copper}} - T_{\text{dryer sheet}}))/L) = ((0.05 \text{ W/m.K})(297\text{K} - 296\text{K})(0.071 \text{ m}^2))/(0.021844\text{m}) = \mathbf{-0.163 \text{ W}}$$

Convection from microfiber sheet through water

$$A = (lw) = (.29\text{m} * .23\text{m}) = 0.071 \text{ m}^2$$

$$k = 0.05 \text{ W/m.K}$$

$$L = 0.021844\text{m}$$

$$T_{\text{copper}} = 23\text{C} = 296\text{K}$$

$$T_{\text{dryer sheet}} = 22\text{C} = 295\text{K}$$

$$q = ((kA(T_{\text{copper}} - T_{\text{dryer sheet}}))/L) = ((0.05 \text{ W/m.K})(296\text{K} - 295\text{K})(0.071 \text{ m}^2))/(0.021844\text{m}) = \mathbf{7.11\text{W}}$$

Convection from dryer sheet to Air

$$A = (lw) = (.29\text{m} * .23\text{m}) = 0.071 \text{ m}^2$$

$$h = 20.88 \text{ W/m.K}$$

$$T_{\text{dryer sheet}} = 22\text{C} = 295\text{K}$$

$$T_{\text{air}} = 21\text{C} = 294\text{K}$$

$$q = (hA(T_{\text{dryer sheet}} - T_{\text{air}})) = ((20.88 \text{ W/m.K})(0.071 \text{ m}^2)(295\text{K} - 294\text{K})) = \mathbf{1.484 \text{ W}}$$

$$\mathbf{\text{System 2 (Copper to Air): } 101.227\text{W} + (-0.163\text{W}) + 7.11\text{W} + 1.484\text{W} = 109.655 \text{ W}}$$

The addition of the heat transfer from the combined systems gives us the total heat transfers of the cooling system, which comes out to 155.65 Watts [1].

System 1 (Body to Rucksack) + System 2 (Copper to Air) = Total heat transfer of Cooling

System 45.995 W+ 109.655 W = 155.65 Watts

Concept Considerations

As shown in the best practices of other concept designs, there are multiple options to improve upon the heat loss or more aptly described a decrease in heat that is retained. A rucksack can be extended off of the back to promote an airflow path between the person and the rucksack. This momentarily solves the heat transfer portion of the problem but introduces a larger moment arm for the back to support, which can negatively impact posture and result in physical harm to the user.

Another concept is the wet t-shirt, where a shirt or cloth is soaked in cold water which creates a larger temperature difference to promote a higher rate of heat transfer. Again, the concept may solve the heat portion of the problem yet creates the uncomfortable irritation and chafing that comes with wearing a wet t-shirt. However, if the wet t-shirt that provides an increased heat transfer is moved away from the body, the irritation of skin is no longer an issue while still increasing heat transfer.

An adapted use for the wet t-shirt concept is an evaporative cooler, commonly known as swamp coolers. These evaporative coolers make use of the latent heat of evaporation by transferring the heat stored in hot air into water, which in turn increases the humidity yet lowers

the air temperature. This mode heat transfer is best described in psychrometric charts in which the components of the operation are shown in Figure 22.

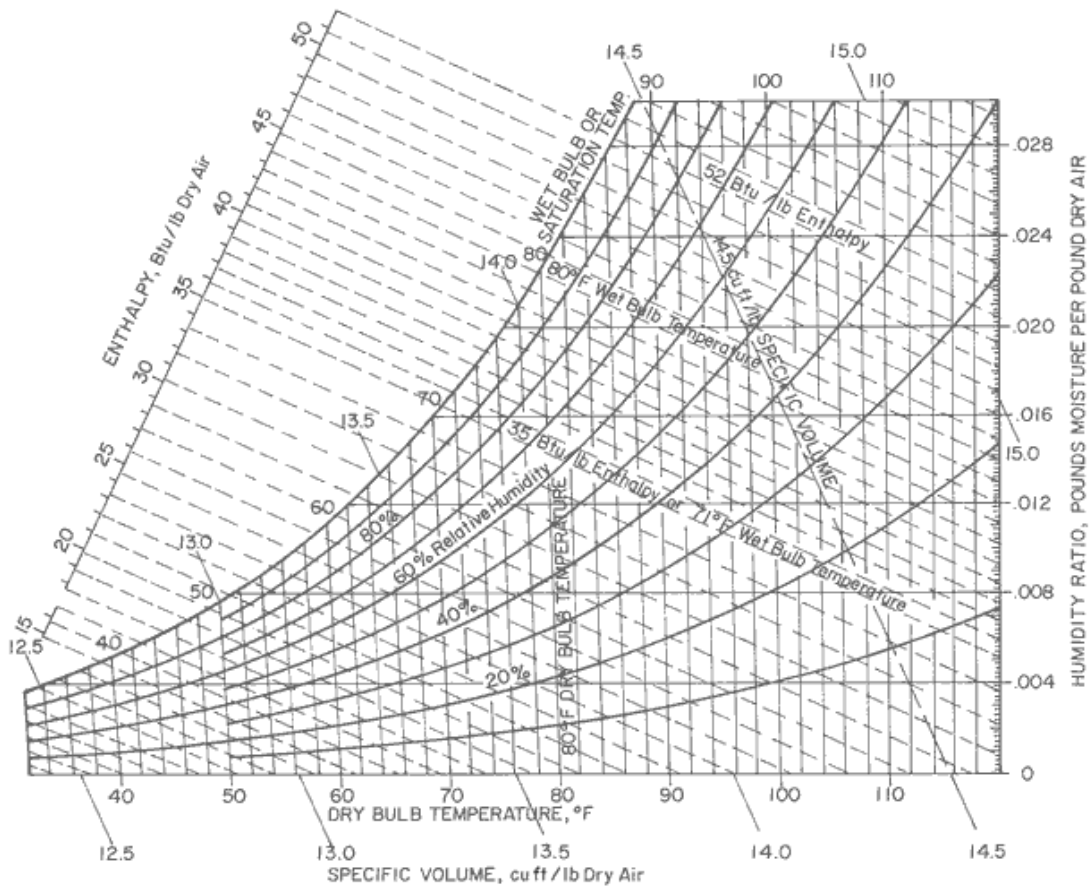

Figure 22: Psychrometric chart displaying physical and thermodynamic properties

Commonly in these evaporative coolers, the pads inside of the cooler provide the absorption of water that is then more able to transfer the heat of the air into the water within the pads. These pads are generally made out of wool, wood fiber, or similar cellulose materials, which can absorb a high amount of water per volume [20].

Methodology

The team focused on developing a functional and reliable device by constructing several prototypes and testing protocols for each. A series of experiments were conducted on separate

portions of the prototype and then completed tests on the combined full prototype. The differing portions are the T-shirt & tubing, the self-sustaining pump, and the evaporative cooling section. These will all be connected and contained within a backpack/rucksack that will then undergo testing as a complete unit.

Proof of Concept

In order to test the core concepts of the proposed device, the team needed to establish basic knowns and assumptions. An initial proof of concept experiment was planned, set up and run multiple times with variances in the testing procedure. The main goal for the experiment was to see how much heat could be transferred from a body to its surroundings, exact procedures are outlined in Appendix B.

In the first test, a beaker containing 37°C water with a tube of room temperature water of 23°C flowing around it. A drill-powered pump was used along with a 5-gallon reservoir of water in a 10-gallon cooler. The 37°C temperature acted as internal body basal temperature. The 23°C water acted as the cooling fluid. The experiment was run until the beaker water reached 32°C

The control that this was compared to was the same beaker of 37°C water except the tubing with cold water running through it was removed. Thus, the control would simulate a body cooling down on its own, in this case down to 32°C. Shown below in Figure 23 is an image of the beaker setup during the experiment.



Figure 23: Proof of Concept Experiment

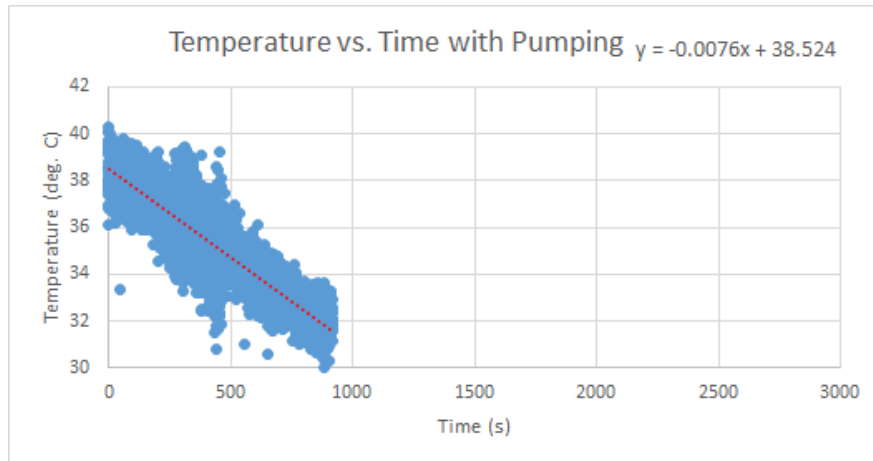

Figure 24: Pumping with Water Circulation

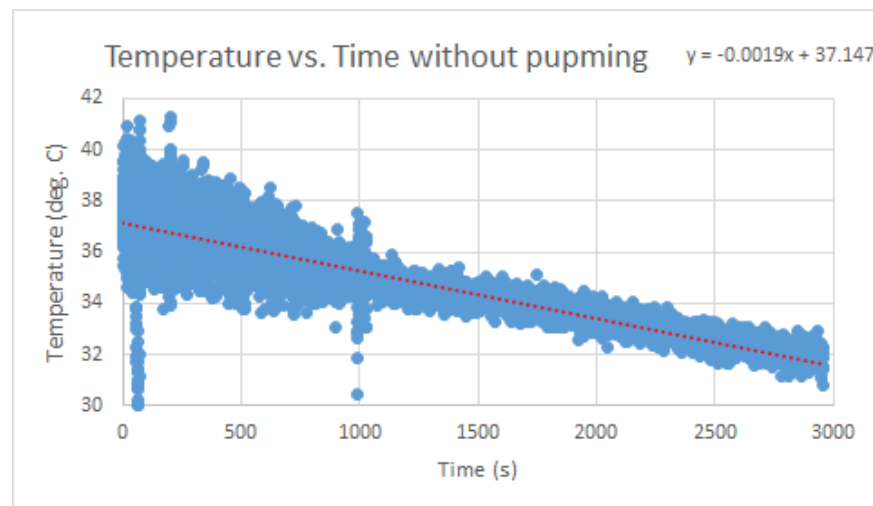

Figure 25: Pumping Without Circulation

However, there were two changes that were made to the experiments: 1) containing the pumping water to the ~70 mL that goes through the tubing and 2) changing the drill powered pump to a peristaltic pump. This improved experiment was conducted and picture below is: The power supply on the right-hand side, with the peristaltic pump connected to the tubes carrying water around the beaker, the computer monitors with National Instruments LabView and the corresponding program, and the National Instruments 16-bit Data Acquisition Box in the top left.

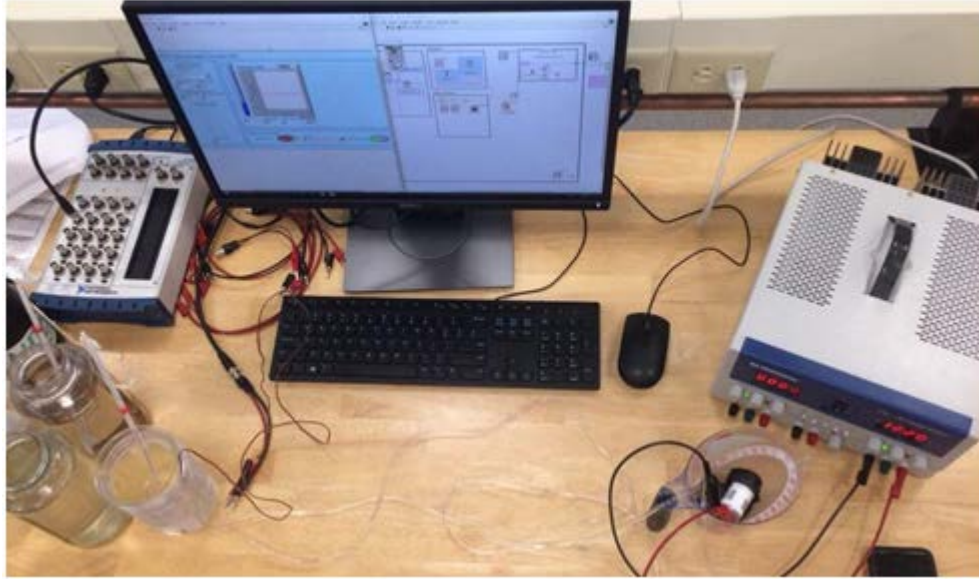

Figure 26: Proof of Concept Experiment Set-Up

Below are the thermal calculations for this proof of concept experiment.

Convection from Tube to Beaker

$$A = (\pi r^2)(h) = (\pi(0.0381\text{m})^2)(0.1397\text{m})$$

$$A = 6.37 * 10^{-4}\text{m}^2$$

$$K = 1.14 \text{ W/m.K}$$

$$D = 0.0016 \text{ m}$$

$$T_{\text{beaker}} = 33\text{C} = 306\text{K}$$

$$T_{\text{material}} = 29\text{C} = 302\text{K}$$

$$Q = ((kA(T_{\text{beaker}} - T_{\text{material}}))/d) = ((1.14 \text{ W/m.K})(306\text{K} - 302\text{K})(6.37 * 10^{-4}\text{m}^2))/(0.0016\text{m})$$

$$Q = \mathbf{1.815 \text{ W}}$$

Convection from Water to Tube

$$D_o = 0.0032 \text{ m}$$

$$D_i = 0.0016 \text{ m}$$

$$A = (\pi r^2)(h) = (\pi(0.0032\text{m})^2) = 3.217 * 10^{-5} \text{ m}^2$$

$$A = (\pi r^2)(h) = (\pi(0.0016\text{m})^2) = 8.043 * 10^{-6} \text{ m}^2$$

$$H = 50 \text{ W}^2/\text{m.K}$$

$$T_{\text{tube}} = 29\text{C} = 302\text{K}$$

$$T_{\text{water}} = 23\text{C} = 296\text{K}$$

$$Q = (2\pi * k(T_{\text{tube}} - T_{\text{water}})) / (k / (h(r_2)) + \ln(r_2/r_1))$$

$$Q = 2\pi * (0.591 \text{ W/m.K})(302\text{K} - 296\text{K}) / (0.591 / (50(0.0032)) + \ln(0.0032/0.0016))$$

$$Q = 5.0788 \text{ W}$$

$$\Delta Q_1 = 1.815 \text{ W} + 5.0788 \text{ W} = 6.8938 \text{ W}$$

As indicated in the thermal calculations above, there was a total heat loss of 6.8938 W between the beaker and tubing.

Prototype

The team began construction of the first prototype by separating the two entities of the product (evaporative panel and cooling shirt), designing, then connecting the concepts after. For the cooling shirt system, the team layered two shirts made of dri-fit (90% polyester, 10% spandex)



Figure 27: Prototype Shirt Inside



Figure 28: Prototype Shirt

together and

ran the polyurethane tubing in between (Figures 27 & 28).

The selected tubing design involved a series of horizontal rows extending across the mid chest to the lower torso of the body. The design was then mimicked on the back of the shirt by simply running the tube up and over the shoulder to connect the two portions. Once the rows were measured, each row was adhesively sewn in patterned sections in

order to permanently connect the two shirts together while allowing the tubing to be removed if necessary (i.e. leaks or becomes clogged). This shirt should be hand washed, however with the tubing removed, can undergo a machine wash for deeper cleaning.

Next, the evaporation system was initially constructed out of PVC piping that was in the shape of a picture frame with copper tubing running horizontally across the frame. On top of the copper tubes was the

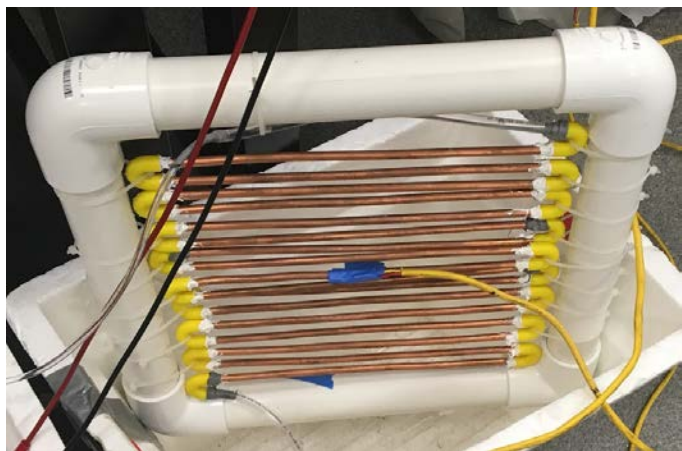

Figure 29: Prototype Evaporation Frame

microfiber sheet. The inlet of the copper tubing was then connected to the outlet of the shirt and the outlet of the copper tubing fed back into the inlet of the shirt. A copper plate was later added between the copper tubing and microfiber sheet to aid in the heat transfer process.

After completing trial experiments with this prototype, the issues discussed in the previous sections were discovered and thus modifications were made. On the second prototype, the team focused primarily on the evaporation frame because the shirt had no issues to speak of. The horizontal copper tubing used in the frame posed



Figure 30: Final Prototype Evaporation Section

issues because the bends were crimped, uneven, and thus affected the flow of the system. For these reasons, the team cut the bends that connected the copper tubing to one another and replaced them with 3D printed PLA bends, which provided the system with uniform, linear tubes. In addition, the humidifier sheet was replaced with a microfiber sheet, which was believed to solve the evaporation issue.

After another phase of testing and evaluation of the product's efficiency, the team elected to construct a modified prototype to rid the frame of its bulky nature. Instead of the oversized PVC

pipings, both the bends and the frame were integrated into one joint entity. This frame, as shown in Figure 31, also provides the system with an inlet and outlet for the connection of the two systems



Figure 31: Final Prototype Sections

that would sleeve onto the polyurethane tubing. In addition, this prototype would provide a reservoir with holes at the top of the system in order to drip water onto the microfiber sheet utilizing gravity.

Prototype Iterations

Evaporation Frame

To conduct preliminary testing and verify the validity of design performance, a prototype was designed and fabricated. The external frame consisted of 1.25" diameter PVC tubing in a rectangle that was 10" wide by 12" tall. Slots were cut along the length of two side pieces for the copper tubing to rest inside of 90-degree corner elbow joints which connected the four sides of the external frame. For the cooling section, 1/8" copper tubing was unrolled from a 10' coil. An extra piece of the 1.25" PVC tubing was used to bend the copper with 180-degree bends to create a radiator shaped tube. Before the copper tubing was bent, it was filled with salt to help prevent the thin walled tubing from collapsing. Although the tubing didn't collapse, the bend radius of 1.25" was larger than desired.

The second iteration of the copper tubing used the same 1/8" tubing from a 20' coil. A pipe bender was used with a 1/8" die which had a bend radius of 0.75". This produced both a tighter configuration and a more uniform bend.

PVC Tension

The second iteration of the prototype redesigned the external frame and the copper tubing section. 180-degree elbow joints were designed in Solidworks and were 3D printed. 1/8" copper tubing from a 20' coil was unrolled into straight sections. These were adhered to the 3D printed elbow joints using Marine RTV sealant to produce the radiator shape. The external frame was rebuilt without slots and the copper tubing section was zip tied to the PVC to keep the frame rigid and secured.

To build the final prototype the frame was 3D printed each of the above designed SolidWorks files and removed burrs and printing excess. Then the straight, quarter inch copper tubing was cut into 8.5-inch lengths and filed smooth. From there the ends of each pipe were coated in silicone gasket maker and inserted into frame pieces which were clamped together and allowed to dry.

While the PVC constructed prototype was good, and was significantly improved with the polymer elbows, it still had its issues. Due to the construction, the connection between the tubes and the elbows were in constant tension, which caused leaking. Additionally, the separation between the tubes were rather inconsistent and inherently unstable. To fix these issues, the new design consists of side walls with integrated pipe bends which are not held in tension and keep all of the tubes on the same plane. To increase durability and rigidity, a 90-degree angle was added to each of the frame sides preventing any warping or bending along the frame.

[CAD Model and Print](#)

While the PVC constructed prototype was good, and was significantly improved with the polymer elbows, it still had its issues. Due to the construction, the connection between the tubes and the elbows were in constant tension, which caused leaking. Additionally, the separation between the tubes were rather inconsistent and inherently unstable. To fix these issues, the new design consists of side walls with integrated pipe bends which are not held in tension and keep all of the tubes on the same plane. To increase durability and rigidity, a 90-degree angle was added to each of the frame sides preventing any warping or bending along the frame.

Drip Well Construction

In replacing the PVC piping with 3D printed parts, a drip well was added to the top of the frame. This piece was designed to contain water above the evaporative pad and slowly drip water onto the pad to keep it saturated. With small holes directly over the piping system the drip well was able to allow water to flow over the pad, which was slowed to a consistent drip after adding a filter to prevent blockage in the event of using dirty water.

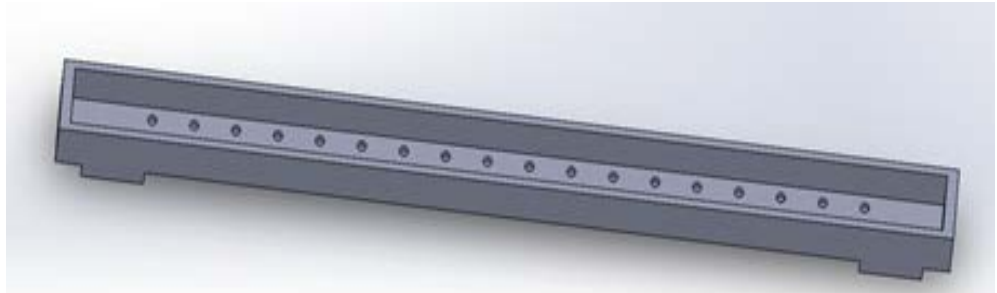

Figure 32: Drip Well Design

Separate System Testing

Once the proof of concept testing was complete, the team could begin to develop and implement testing protocols, seen in Appendix F, for separate portions of the system to ensure each worked separately before combining the entire system.

T-Shirt and Tubing

The initial portion of the system involves the direct interaction between the body and conductive cooling. This primary conduction zone will remove heat from the user and transfer that heat to the flowing water. The flowing water is carried in polyurethane (PU) tubing that is positioned between two athletic shirts in a horizontally alternating pattern. This tubing is divided into a front and back section. Each panel section contains approximately ten feet of tubing that is secured between iron-on stitching tape and a few securing stitches at tube bend locations. The panels each include an input and output tube to connect to the evaporative cooling box with the copper piping.

Evaporation

The second portion of the prototype is the evaporative cooling section where heat is dissipated from the system. Water in the plastic tubing will transition into the copper tubing that

has been arranged into a flat condenser configuration. This copper tubing is encased by the microfiber cloth which rests within a rectangular 3D printed frame. In order to receive the full benefit of the microfiber filter, water will be stored in a reservoir at the top and drip through small filtration holes. This water will drip down and thoroughly wet the entire piece of microfiber cloth through capillary action. Testing of the evaporative cooling section include several types of tests outlined in the appendix. The first test that was completed was testing whether water would be able to properly flow through the copper pipe.

Using the peristaltic pump to draw water from a beaker, water is passed through the plastic tubing into the copper pipe, with thread seal tape to seal the connection. Water flowed out of the end of the copper pipe at 55 ml/min at a voltage setting of 12V on the power supply, as seen in the Figure 33 below.



Figure 33: Proof of Concept Set Up

The following test to be conducted will introduce a breeze across the evaporative cooling section. This will hypothetically increase heat loss as a means of increasing evaporation by introducing an air flow. A hairdryer will be used in two different variations of the test, with varying

speed from low to medium speeds. The hairdryer will be used on the cool and a warm setting to show variance in wind and act as humid climates.

Pump

In order to fully test and evaluate the effectiveness of the evaporative cooling portion of the project, the use of the biomechanically powered, self-sustaining pump was not practical. In testing, the cooling system requires a consistent flow, which could not be accomplished with a manually operated pump. As a result, the team opted for a DC pump to maximize the accuracy of our testing. To maintain consistency in an experimental environment, the team opted to utilize a power source when conducting testing and took the solar powered pump as a known constant.

Secondary Prototype Testing

With the updated 3D printed prototype design, the team conducted the following experiments.

No microfiber sheet test

The prototype is set up as described in the Evaporative Cooling Experiment and is run without a microfiber sheet or breeze on the section. Two of the no microfiber sheet tests were run in preliminary testing

No breeze over wet microfiber sheet test

In the next set of testing formats, the microfiber sheet is placed over the copper coils of the evaporative cooling section. Once water has been pumped through the system, 1 oz of water is sprayed onto each side of the microfiber sheet using the spray bottle. No breeze is supplied by the small personal fan in this set of tests. Two of the no breeze over wet microfiber sheet tests were run in preliminary testing.

Cool breeze over wet microfiber sheet test

This set of tests repeats the same procedure as the no breeze over wet microfiber sheet test up until the breeze portion. In this set of tests, a small personal fan is used on its lowest speed

setting. The small personal fan is aimed at the evaporative cooling sheet. Two of the no breeze over wet microfiber sheet tests were run in preliminary testing.

Warm breeze over wet microfiber sheet test

This set of tests repeats the same procedure as the cool breeze over wet microfiber sheet test up until a hair dryer is exchanged for the small personal fan to adjust the heat setting. The hair dryer is set to its lowest speed setting and its medium (“warm”) heat setting, warm and is aimed at the evaporative cooling sheet. Two of the no breeze over wet microfiber sheet tests were run in preliminary testing.

Insulated evaporative cooling test

This set of testing incorporates insulating the evaporative cooling section to measure how the temperature differs compared the cooling testing. A thick towel is wrapped around the evaporative cooling section and the test is run as it is in the base test. Three of the no breeze over wet microfiber sheet tests were run in preliminary testing.

Final Prototype Testing

Static full test

This set of testing adds in the shirt with tubing worn by the test subject into the experiment. Tubing carries water from the pump to the inlet of tubing of the back of the shirt. From here, the cool breeze over wet microfiber sheet test procedure steps in, but with the test subject sitting wearing the shirt, and with one additional step. Every 5 minutes, 1 oz of water is poured into the top reservoir to drip onto the evaporative cooling section. Three of the static full tests were run in final testing.

Dynamic full test

The final testing will be done on the closed loop, combined prototype. The final assembly will include the shirt with tubing being worn, where the tubing is fed into a rucksack that contains the auxiliary peristaltic pump, and a battery. The evaporative cooling section will be mounted to

the back of the rucksack with the tubing leading out of the pump into the copper tubing. Four versions of this test will occur, with a team member wearing the t-shirt and backpack, and working in intervals of two minutes of activity, one minute of standing rest, repeated for 5 cycles within a 15-minute interval. This test will include the subject participating in four different exercises: bicep curls, tricep extensions, flutter kicks, and squats.

The consistent climate of the lab space will allow for testing to determine the effectiveness of the cooling system on the user as their internal body temperature rises. These tests will be evaluated based on the unit's ability to remove heat from the user's body and will also provide a baseline test for the durability and comfortability for the user. Further testing will require a change in climates, as well as more extensive exercise to replicate the intended purpose of the product. Once the completed unit with the peristaltic pump has been determined to be effective in testing, the power source could be replaced with a solar-powered pump with battery backup to fully complete the design.

Results

No microfiber sheet test

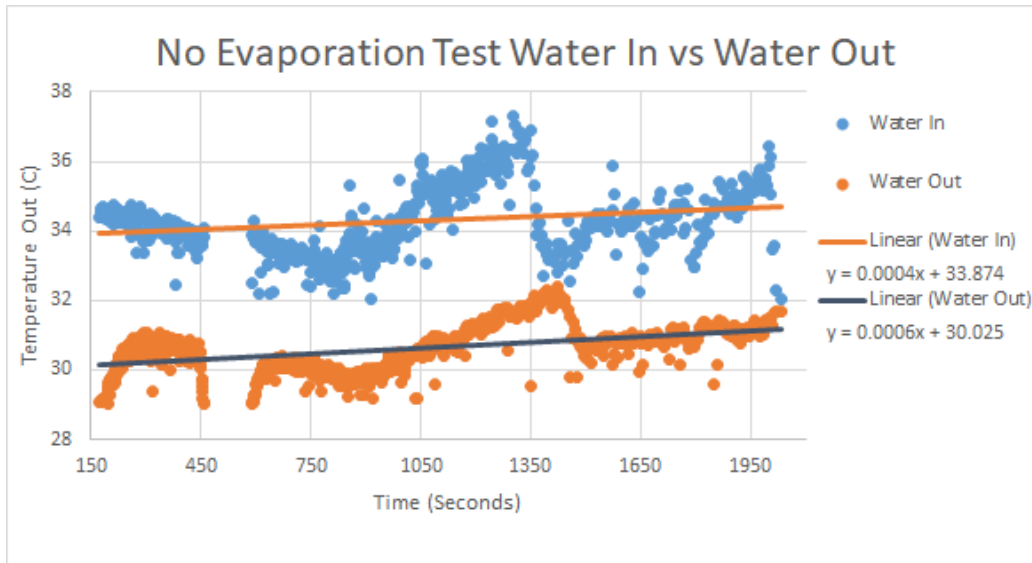

Figure 34: No MicroFiber Sheet Experiment Results

Seen in in Figure 34 is the data from the no evaporation test. In blue is the temperature reading from the warm water in, and in orange is the temperature reading of the water out of the evaporative cooler. Seen in in Figure 35 below is a graph of the temperature difference between the hot water in and the water out. The temperature difference average 4°C throughout the experiment.

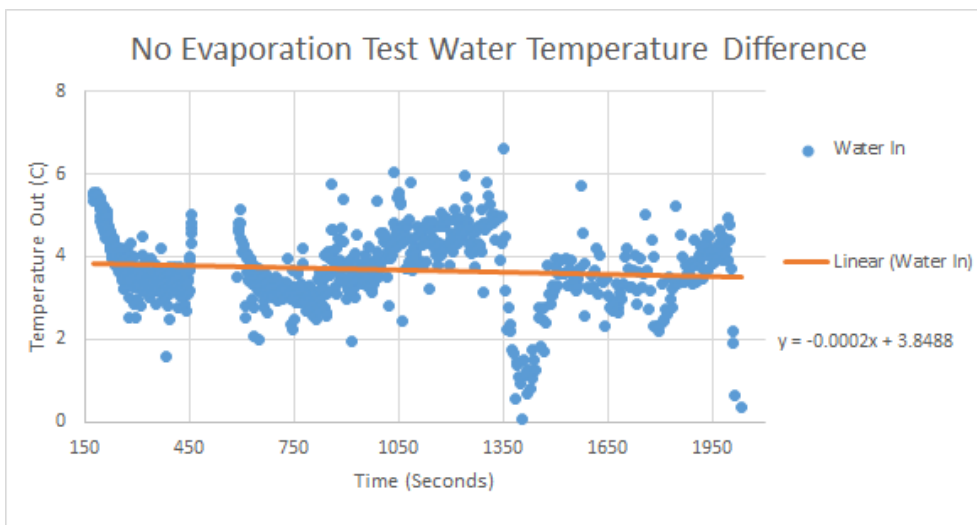

Figure 35: No MicroFiber Sheet Experiment Temperature Difference

No Breeze over Wet Microfiber Sheet Test

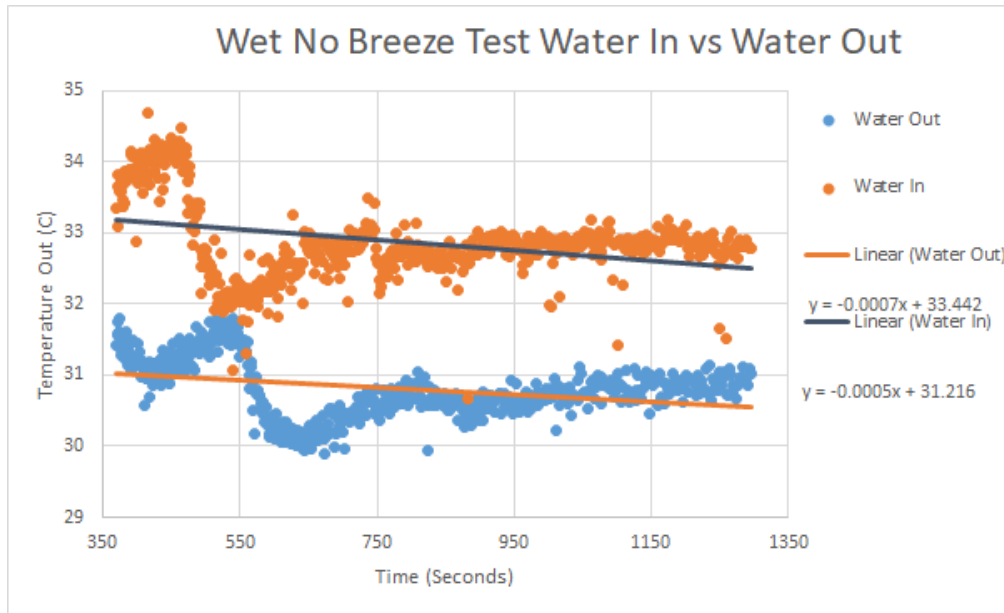

Figure 36: No breeze over wet microfiber sheet test

Seen in Figure 36 is the data from the wet no breeze test. In orange is the temperature reading from the warm water in, and in blue is the temperature reading of the water out of the evaporative cooler. Seen in Figure 37 below is a graph of the temperature difference between the hot water in and the water out. The temperature difference averaged 2°C throughout the experiment.

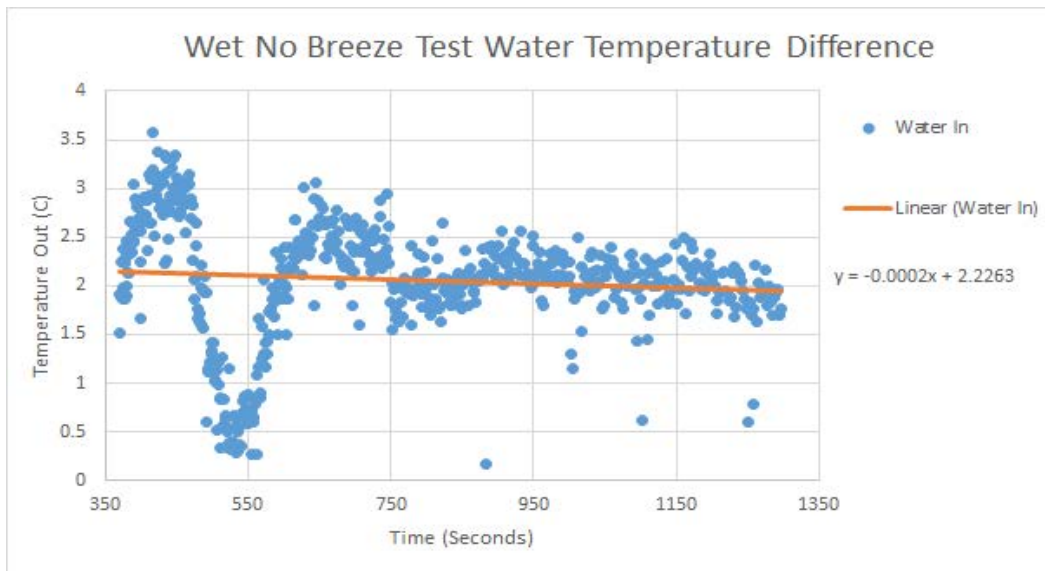

Figure 37: Wet No Breeze Test Water Temperature Difference

Cool breeze over wet microfiber sheet test

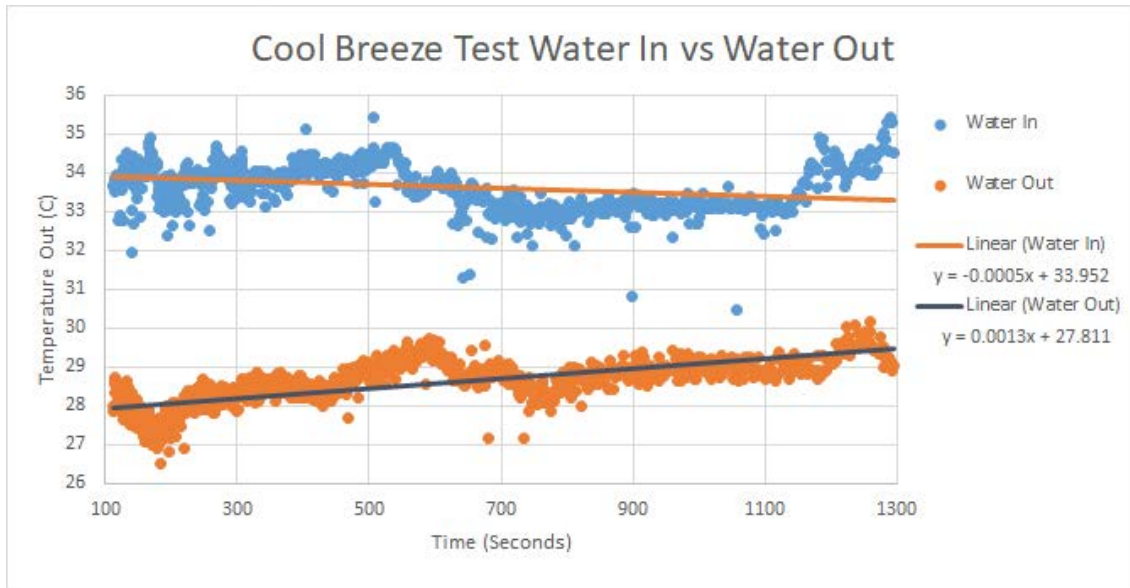

Figure 38: Cool breeze over wet microfiber sheet test

Seen in in Figure 38 is the data from the cool breeze test. In blue is the temperature reading from the warm water in, and in orange is the temperature reading of the water out of the evaporative cooler. Seen in in Figure 39 below is a graph of the temperature difference between the hot water in and the water out. The temperature difference averaged 5°C throughout the experiment.

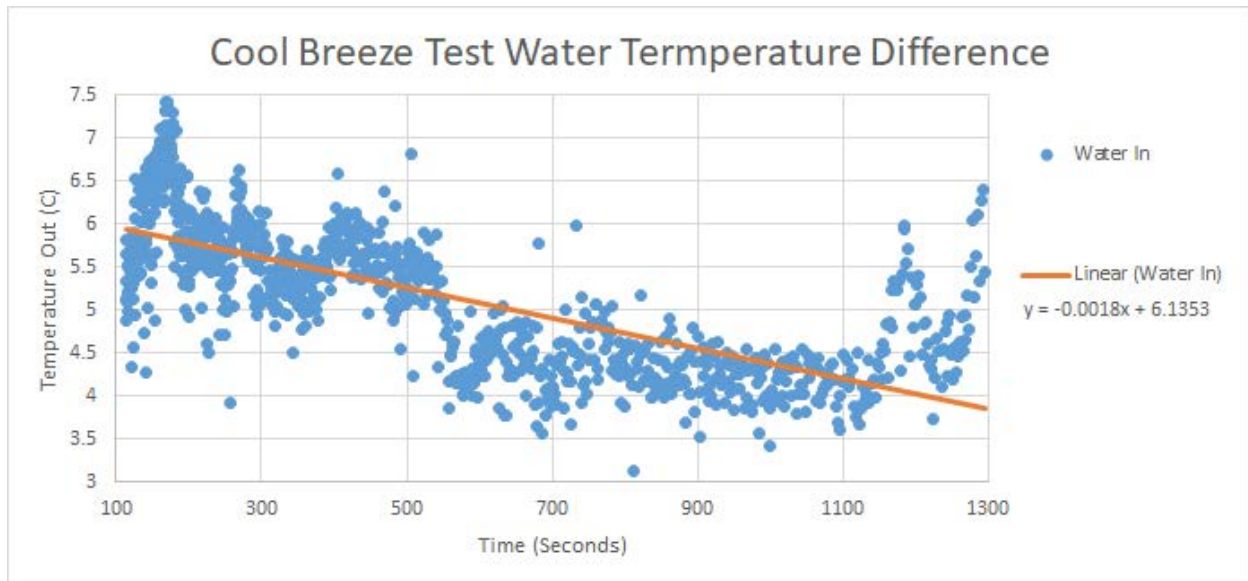

Figure 39: Cool breeze over wet microfiber sheet Temperature Difference

Warm breeze over wet microfiber sheet test

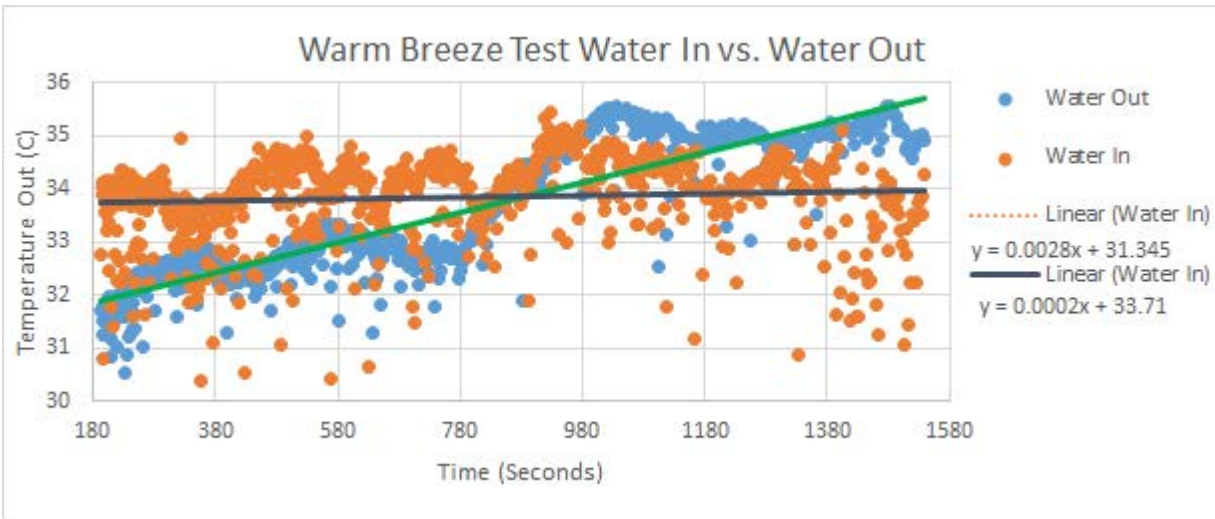

Figure 40: Warm breeze over wet microfiber sheet test

Seen in Figure 40 is the data from the warm breeze test. In orange is the temperature reading from the warm water in, and in blue is the temperature reading of the water out of the evaporative cooler. Seen in Figure 41 below is a graph of the temperature difference between the hot water in and the water out. The temperature difference averaged 0°C throughout the experiment.

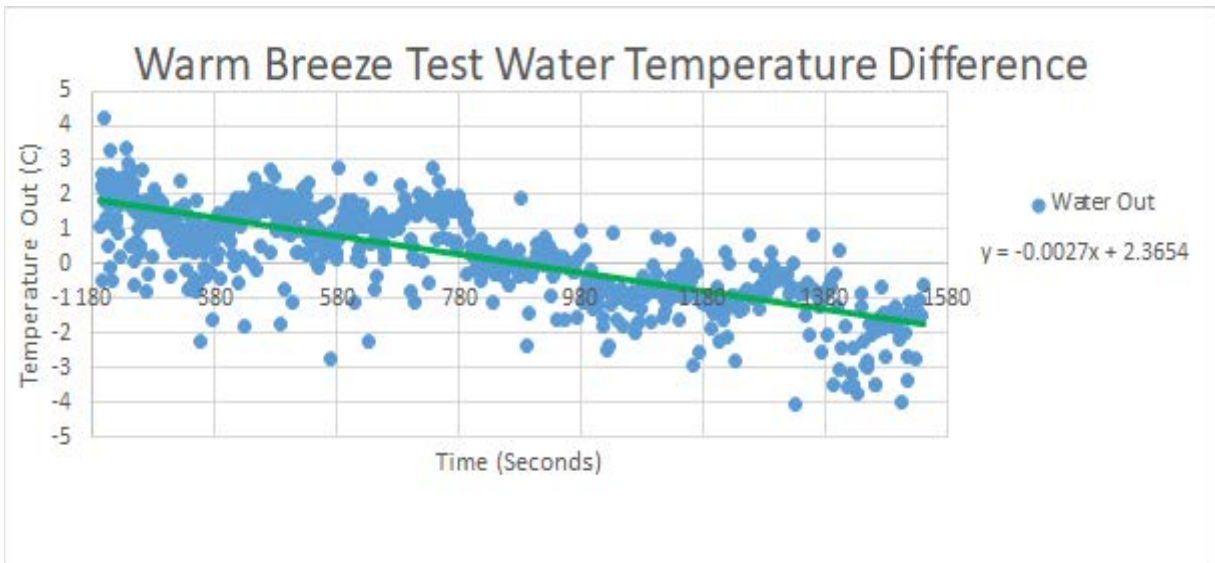

Figure 41: Warm breeze over wet microfiber temperature difference

Insulated evaporative cooling test

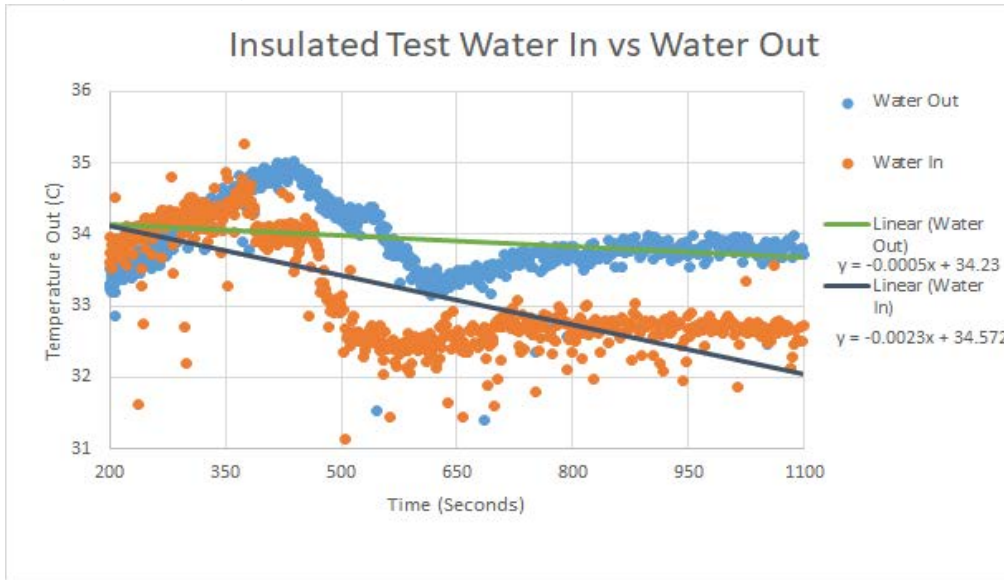

Figure 42: Insulated evaporative cooling test

Seen in Figure 42 is the data from the no evaporation test. In orange is the temperature reading from the warm water in, and in blue is the temperature reading of the water out of the evaporative cooler. Seen in Figure 43 below is a graph of the temperature difference between the hot water in and the water out. The temperature difference averaged 1°C of temperature gain to the system throughout the experiment. This is hypothesized to be due to friction between the water and the thin cylinder walls of the copper, plastic and 180° bends.

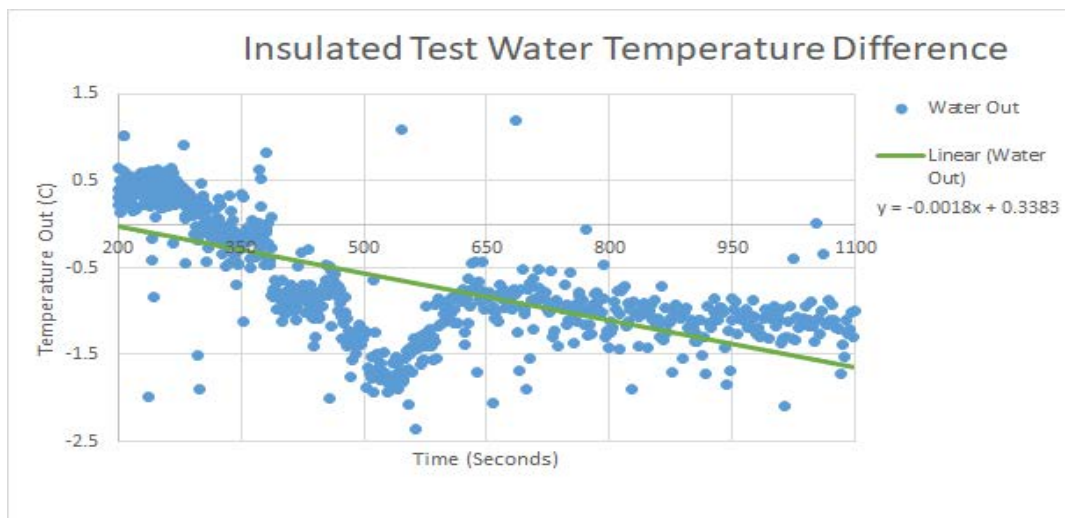

Figure 43: Insulated evaporative cooling temperature difference

Static test

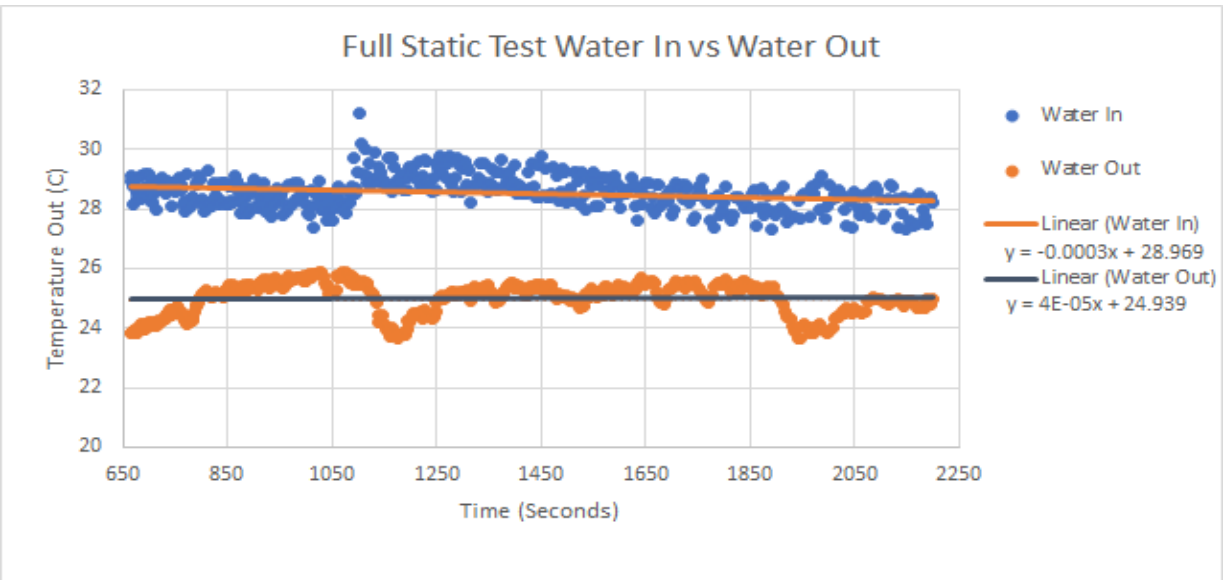

Figure 44: Static Test

Seen in Figure 44 is the data from the full static test. In blue is the temperature reading from the warm water in, and in orange is the temperature reading of the water out of the evaporative cooler. Seen in Figure 45 below is a graph of the temperature difference between the hot water in and the water out. The temperature difference average 3.5°C throughout the experiment.

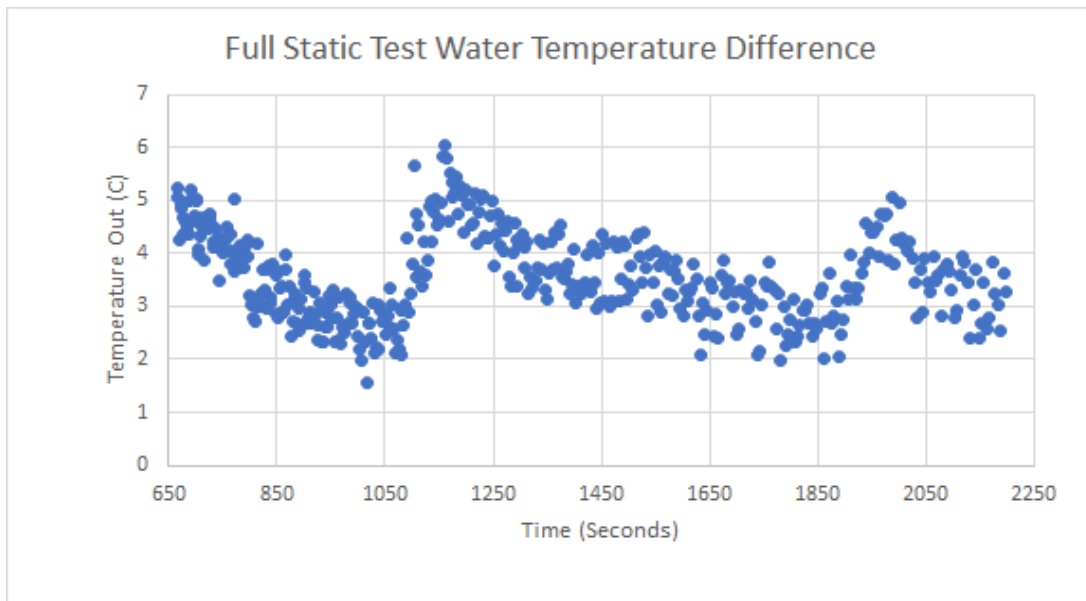

Figure 45: Static Test Temperature Difference

Overview of Preliminary Tests

Table 8 compares the temperatures and temperature difference between the tests that were conducted. The best tests based on temperature difference were Cool Breeze with 5 degrees, No evap with 4°C & Static Full with 35°C. The best tests based on percentage temperature difference were Cool Breeze at 14.7%, Static Full at 12.3% & No evap at 11.7%. The best tests based on percentage temperature difference to atmosphere were Static Full at 53.8%, Cool Breeze at 41.7% & No evap at 33%.

All in Degrees Celsius	No Evap	Wet No Breeze	Cool Breeze	Warm Breeze	Insulated	Static Full
Hot In	34	33	34	34	33	28.5
Out	30	31	29	34	34	25
Difference	4	2	5	0	-1	3.5
% Difference	11.7%	6%	14.7%	0%	-3%	12.3%
% to 22 deg. Atmosphere	33%	18.2%	41.7%	0%	-7.7%	53.8%

Table 9: Overview of Preliminary Tests

Final Results

Static full test

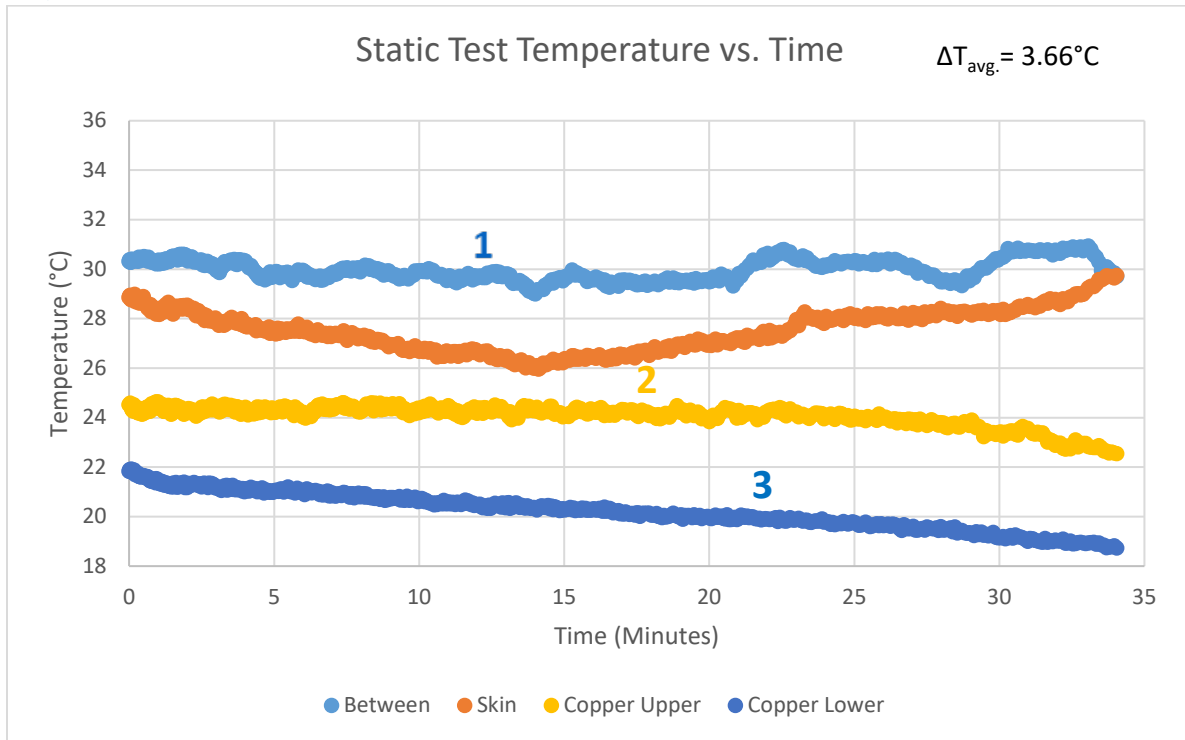

Figure 46: Static Full Test

Seen in Figure 46 is the data from the static full test. In bright blue, labeled with a number “1”, is the temperature reading from the water into the top of the shirt. The yellow line, labeled with a number “2”, is the temperature reading from the top of the evaporative cooler copper tubing, and the dark blue line, with a number “3”, is the temperature reading from the bottom of the evaporative cooler copper tubing. The orange line is the temperature reading from a thermocouple attached to the test subject’s back. The average temperature difference between the top and the bottom of the evaporative cooler averaged 3.66°C throughout the experiment.

Dynamic Full Test

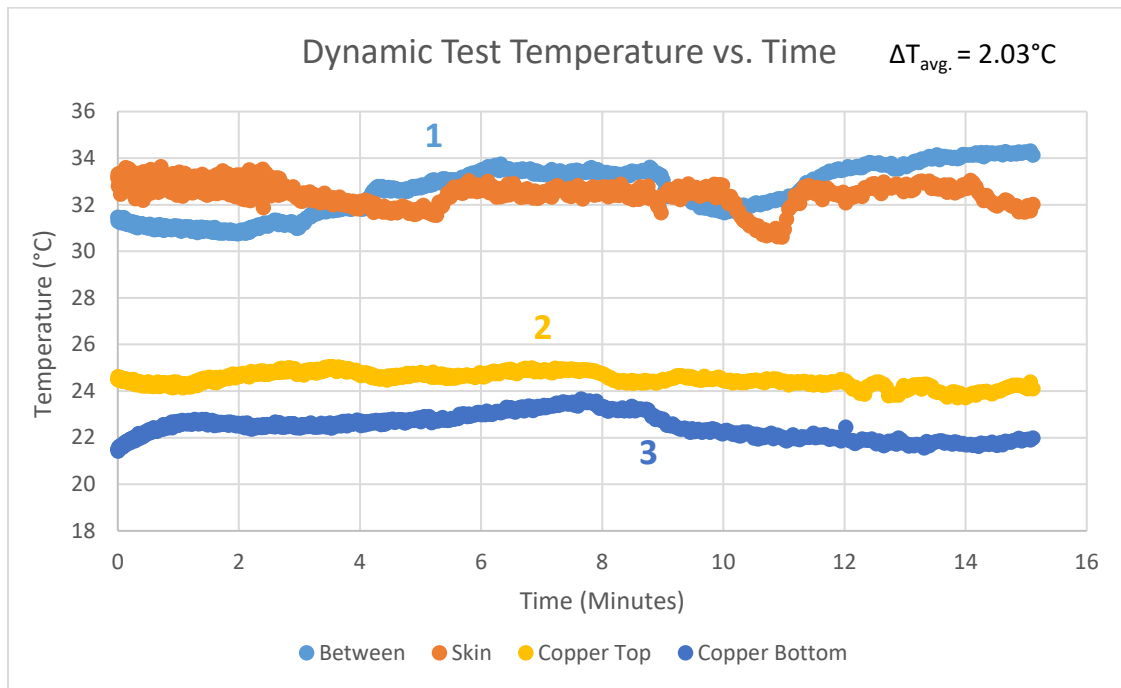

Figure 47: Dynamic Full Test

Seen in Figure 47 is the data from the dynamic full test. In bright blue, labeled with a number “1”, is the temperature reading from the water into the top of the shirt. The yellow line, labeled with a number “2”, is the temperature reading from the top of the evaporative cooler copper tubing, and the dark blue line, with a number “3”, is the temperature reading from the bottom of the evaporative cooler copper tubing. The orange line is the temperature reading from a thermocouple attached to the test subject’s back. The average temperature difference between the top and the bottom of the evaporative cooler averaged 2.03°C throughout the experiment.

With the final static and dynamic full tests completed, the total heat transferred through the system can be calculated and was determined to be 156 W. Comparing this value to Table 4 on metabolic heat production, this system will provide cooling near a human exerting “Light” to “Moderate” activity levels.

Discussion

Test Protocol

The testing procedures for the experiments developed throughout the project to incorporate additional design features, more efficiently recorded data, and conduct more effective experiments by recording meaningful data. The LabView program was improved to utilize multiple thermocouple and write data points with an average computing 100 samples per second. The thermocouples were fit with boots on the positive and negative out wires so that they can be attached to a single terminal block. The terminals provide much better contact than the banana clips that were previously used, and thus provide more precise and accurate data. The procedure was also optimized and with multiple members aiding in setting up and conducting the experiments, the experiments' overall progress time was made significantly more efficient.

Prototype Iterations

Tubing

Design and construction of the prototype iterations evolved as more information and improved practices were acquired. When the first copper evaporation system tubing was bent into shape, salt was poured into the tubing to prevent the copper tube from collapsing. Although this was effective, it was later learned that salt can be compressed, and that sand is the best material to use for this process as it is not compressible. The next improvement that was made was using a dedicated pipe bender over bending the copper tubing over a PVC pipe. This allowed for more consistent bending as well as a more controlled operation. The final prototype iteration contained straight copper pipes fit into 3D printed 180-bends within the side rails of the frame. This provided the greatest security of the pipes, the most watertight system, and the cleanest appearance.

Frame

The main problem that occurred with the second iteration of the prototype, was that the copper frame was constantly pulled in tension onto the PVC frame. This initially was done to

constrain the frame and keep the copper tubing rigid to the frame. However, this change ultimately ended in the demise of this prototype as the elbow joints were constantly pulled apart. This made them no longer waterproof, and the system leaked. The pump that was used was unable to provide enough pressure as it was losing water at leaks at many points on the evaporative cooling section. This would be the major change to the next iteration of the evaporative cooling section to prevent the device from leaking.

Testing

Amongst the testing results, multiple experiments were not run at a steady and consistent temperature for a long enough period. Fluctuations to the temperature were caused by the hot plate being on and adding ice to maintain a constant temperature. However, this was a tedious task that required constant attention. It also takes between 90 to 150 seconds for the water to be pumped all the way through the system, thus fluctuations in inlet temperature reading would not be seen at the outlet temperature reading for those 90 to 150 seconds. This produces a translation to the right in the temperature difference between the water going out of the system compared to the water going into the system where temperature fluctuations increase the difficulty of accurate data analysis.

The insulated test also provided an increase in temperature, which is hypothesized to be due to friction within the system. As no outside force was acting on the system, the only internal mechanism that could have provided this increase in temperature is friction.

Further Research

As we brainstorm about how this project can be improved, the thought of internal body processes such as homeostasis, cardiovascular rates, caloric rates and perspiration all represent aspects about the body that could potentially change the dynamic of the project.

Conclusions

Through the process of designing and testing the device, the team has learned a series of valuable lessons, as well as compiling a list of recommendations which will maximize its effectiveness. As military and law enforcement personnel are already carrying excessive amounts of weight it is imperative that the design of this system remains as lightweight as possible, which was a challenge for our team which could be maximized in future iterations of the project. Additionally, to make the product the most effective it must be designed to be as simple as possible in order to mitigate potential breaks and technical issues, coupled with a ruggedized exterior design.

This project would benefit significantly from further research into durability and sustainability, in order for it to be more effective in the field of use. In addition, further research into the concepts of homeostasis, microclimates, cardiovascular rates, caloric rates and perspiration would provide adequate information to potentially improve the duration of cooling. Finding the perspiration, cardiovascular and caloric rates of an individual with and without the system on, would provide data for the amount of BTU's expelled by an individual, which can be cross-referenced to provide concrete analyses on the effectiveness of the system.

The initial goal of the system was to aid in dissipating heat from the body similar to light to moderate activity of around 150 Watts. Citing the temperature differences in the varying components of the system, the system was able to dissipate a heat rate of 156 W, which completed the initial goal.

At the conclusion of the design and testing processes the team has determined that this product will provide effective cooling for individuals who are susceptible to heat related injuries as a result of their environment. While the temperature change is not as drastic as other products

which incorporate the use of batteries or refrigeration, it is the only design which is truly independent of outside resources to reduce heat in these conditions.

References

- [1] Abdel-Rehim. (2006, September). Textile Fabrics a Thermal Insulators. Retrieved December 2, 2017, from http://www.autexrj.com/cms/zalaczone_pliki/5-06-3.pdf
- [2] Al-Badri, S. B. S. (2014). Determination the heat performance for the evaporative cooling pads. AMA, Agricultural Mechanization in Asia, Africa and Latin America, 45(2), 7-10.
- [3] Ansari, A. (2015, October 1). A Survey of Current Exoskeletons and Their Control Architectures and Algorithms. Retrieved December 2, 2017, from <http://www.cs.cmu.edu/~cga/exo/survey.pdf>
- [4] Bull, Jeffrey W. (1999, April 28). Patent EP0910978A1 - Drive mechanism for salad spinner and the like. Retrieved December 14, 2017, from <https://www.google.com/patents/EP0910978A1?cl=en>
- [5] Climate Research Unit, Univ of East Angola, "Average Annual Temperature," vol. 2018.
- [6] Commandant of the Marine Corps, "Marine Corps Body Composition and Military Appearance Form," Department of the Navy., pp. 24, 2016.
- [7] R.D. Mosteller, "Simplified calculation of body surface area," N Engl J Med, 1987.
- [8] J. Desjardinis, "U.S. Military Personnel Deployments by Country," vol. 2017, -03-18. 2017.
- [9] D. Du Bois, "A formula to estimate the approxiamate surface area if height and weight be known," Archives of Internal Medicine, vol. 17, pp. 863-871, June. 1916.
- [10] Engineering Toolbox, "Convective Heat Transfer".

- [11] S.B.S. Al-Badri, "Determination the heat performance for the evaporative cooling pads," *AMA Agric Mech Asia Afr Lat Am*, vol. 45, pp. 7-10, 2014.
- [12] J.K. Jain and D.A. Hindoliya, "Correlations for Saturation Efficiency of Evaporative Cooling Pads," *Journal of the Institution of Engineers (India): Series C*, vol. 95, pp. 5-10, 2014.
- [13] P. Martínez, J. Ruiz, C.G. Cutillas, P.J. Martínez, A.S. Kaiser and M. Lucas, "Experimental study on energy performance of a split air-conditioner by using variable thickness evaporative cooling pads coupled to the condenser," *Applied Thermal Engineering*, vol. 105, pp. 1041-1050, 2016.
- [14] M.C. Ndukwu, F.I. Abam, S.I. Manuwa and T.A. Briggs, "Exergetic performance indicators of a direct evaporative cooling system with different evaporative cooling pads," *Int J Ambient Energy*, pp. 1-9, 2016.
- [15] R.W. Koca, "Evaporative cooling pads: test procedure and evaluation," *Appl.Eng.Agric.*, vol. 7, pp. 485-490, 1991.
- [16] M. I. Mohammed and M. P. Y. Desmulliez, "Characterization and Theoretical Analysis of Rapidly Prototyped Capillary Action Autonomous Microfluidic Systems," *Journal of Microelectromechanical Systems*, vol. 23, pp. 1408-1416, 2014.
- [17] H. Wang, J. Liang, Y. Peng, H. Zhou, Z. Huang, Y. Zhang and L. Hua, "Coupled wetting meniscus model for the mechanism of spontaneous capillary action," *Applied Mathematical Modelling*, vol. 50, pp. 200-218, 2017.
- [18] W. Xu, "Lewis factor and its effect on performance of plate evaporative cooler," *Tngj Dxu Xubo (1980)*, vol. 36, pp. 81-5, 2008.

- [19] J. Lee and D. Lee, "Experimental study of a counter flow regenerative evaporative cooler with finned channels," *International Journal of Heat and Mass Transfer*, vol. 65, pp. 173-179, 2013.
- [20] C. Ren, "Experimental investigation of thermal performance of indirect evaporative cooler," *Re Ke Xue Yu Ji Shu : Gao Deng Xue Xiao Gong Cheng Re Wu Li Xue Bao*, vol. 6, pp. 331-5, 2007.
- [21] S. Son, "Effects of axial-conduction loss on the performance of a regenerative evaporative cooler," in *ACRA 2014 - Proceedings of the 7th Asian Conference on Refrigeration and Air Conditioning*, 2014.
- [23] S.B. O'Sullivan, *Physical Rehabilitation*; Philadelphia: F.A. Davis Company, 2007, pp. 1098.
- [24] Institute of Medicine Staff and B.M. Mariott, "Nutritional Needs in Hot Environments : Applications for Military Personnel in Field Operations," National Academy Press., 1993.
- [25] Foglyano, K. M., Kobetic, R., To, C. S., Bulea, T. C., Schnellenger, J. R., Audu, M. L., . . . Triolo, R. J. (2015, March 18). Feasibility of a Hydraulic Power Assist System for Use in Hybrid Neuroprostheses. Retrieved December 14, 2017, from <https://www.hindawi.com/journals/abb/2015/205104/>
- [26] Holmes. (n.d.). Thermal Properties. Retrieved November 16, 2017, from <http://users.ece.utexas.edu/~valvano/research/Thermal.pdf>
- [27] How do peristaltic dosing pumps work? (n.d.). Retrieved December 14, 2017, from <https://www.verderflex.com/en/how-do-peristaltic-pumps-work/>

- [28] Kothandaraman, C. P. (2012). *Fundamentals of heat and mass transfer*. New Delhi: New Age International (P) Limited.
- [29] Meyer, J. (2007, April 1). Bellows pump works cleanly and quietly. Retrieved December 14, 2017, from <http://medicaldesign.com/components/bellows-pump-works-cleanly-and-quietly>
- [30] Ramires. (1994, July 6). Standard Reference Data for the Thermal Conductivity of Water. Retrieved November 30, 2017, from <https://www.nist.gov/sites/default/files/documents/srd/jpcrd493.pdf>
- [31] Schroeder, T. (n.d.). The Quick And Dirty Guide To External Gear Pumps. Retrieved December 14, 2017, from <https://blog.craneengineering.net/the-quick-and-dirty-guide-to-external-gear-pumps>
- [32] Thermal Conductivity. (n.d.). Retrieved December 14, 2017, from <http://hyperphysics.phy-astr.gsu.edu/hbase/Tables/thrcn.html>
- [33] Uicker, John J. Theory of Machines and Mechanisms I. (n.d.). Retrieved December 14, 2017, from <https://books.google.com/books?id=oCbM7kwNFtIC&pg=PA15&lpg=PA15&dq=locomotive%2Bwheel%2Bmechanism&source=bl&ots=roCo4HJF9H&sig=UEDud5YQwpFj1bujJoaiLIci7WM&hl=en&sa=X&ved=0ahUKEwjCpIeg8onYAhWEMSYKHZpRDEQQ6AEIoAEwGQ#v=onepage&q=locomotive%20wheel%20mechanism&f=false>
- [34] Wilson, M. (n.d.). Understanding Roller Ring Linear Actuators. Retrieved December 14, 2017, from <https://www.amacoil.com/articles05.html>
- [35] Xu, W. (2008). Lewis factor and its effect on performance of plate evaporative cooler. *Tngj Dxu Xubo (1980)*, 36(1), 81-5.

Appendices

Appendix A: Peristaltic Pump Output Data

Voltage (V)	Time (s)	Volume (mL)	Flow Rate (mL/min)	Flow Rate/Volt (mL/(V*min))
5.65	0:02:40	50	18.75	3.32
8.99	0:03:46	100	26.55	2.95
12.08	0:01:43	100	58.25	4.82
15.00	0:01:16	100	78.95	5.26

Appendix B: Other Human Factors Information

Activity and Metabolic Weight (mean surface area human body ~1.8 m²)

- Sitting: 58 W/m²
- Standing: 70 W/ m²
- Moving activity: 116 W/ m²
- Harder activity: 165 W/ m²

Metabolic Heat Gain from Humans

- Average Metabolic Rate (adult male, W)
- 1 W = 3.41 BTU/hr
 - Walking/seated: 150 W
 - Standing/slow walking: 130 W
 - Fast walking (Mountain walking): 300 W
 - Heavy work (athletics): 430 W

Comfort Levels

- Discomfort index (DI): higher value, higher discomfort
 - $DI = 0.4 * (\text{dry bulb temp} + \text{wet bulb temp}) + 15$
 - $DI = .55 * (\text{dry bulb temp}) + .2 * (\text{dew point temp}) + 17.5$

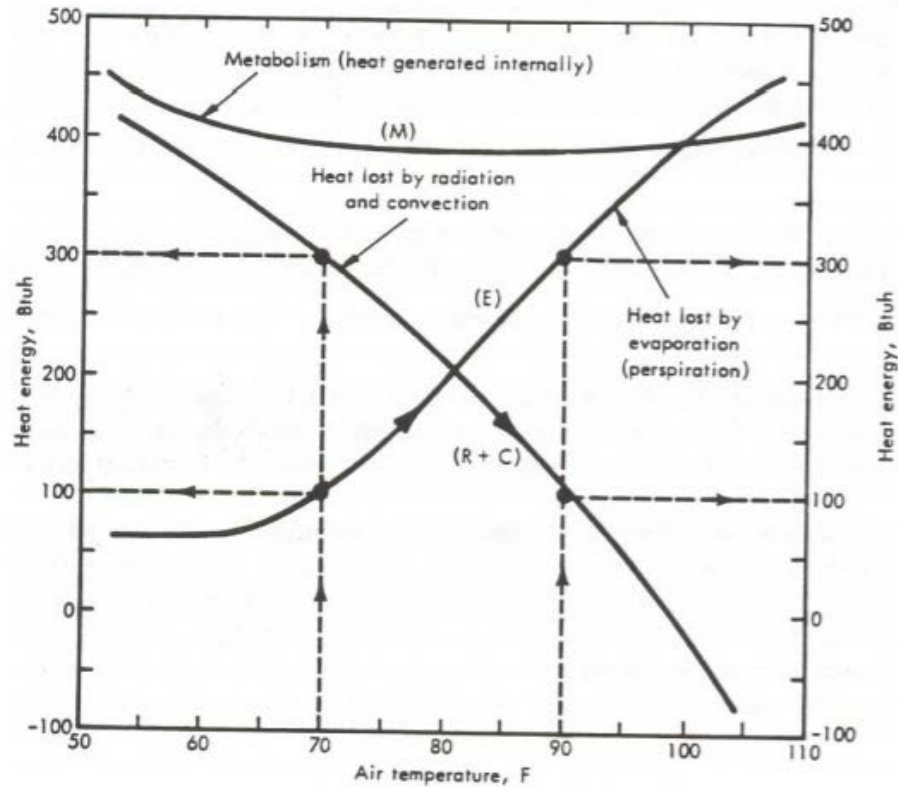

Appendix C: Heat Calculations

	Material	Heat Transfer Coefficient h (W/m ² *K)	Thermal Conductivity k (W/m*K)	Height h (m)	Surface Area A (m ²)
Conduction with No Flow					
System 1					
Body through Skin	Skin		0.3		0.137
Skin of Back through Shirt	Polyester		0.05		0.137
Shirt through Tube	Polyester		0.05		0.137
Tube through Water	Polyurethane		0.02		0.137
Water through Tube	Water		0.6		0.137
Tube through Shirt	Polyester		0.05		0.137
Heat Transfer Body to Ruck					
Convection with Flow					
System 2					
Water through Copper	Copper	100	385	2.0907	0.14461
Copper through Microfiber Sheet	Polyester		0.05		0.07106840625
Microfiber Sheet through Water		100	385		0.07106840625
Water to Air	Air	20.88215957			0.07106840625
Heat Transfer to Air					
Total Heat Transfer Rate of System 1 & 2			180.2		

Length L (mm)	Thickness L (m)	Temp. C (Celsius)	Temp. C (Celsius)	Temperature T (Kelvin)	Temperature T (Kelvin)	Heat Transfer Rate Q (W) $q = kA((T1-T2)/L)$	Units
2	0.002	34	32.5	307	305.5	30.825	Watts
0.381	0.000381	32.5	32	305.5	305	8.989501312	Watts
4.064	0.004064	32	25	305	298	11.79872047	Watts
4.064	0.004064	25	30	298	303	-3.371062992	Watts
4.064	0.004064	30	31	303	304	-20.22637795	Watts
0.381	0.000381	31	32	304	305	17.97900262	Watts
				System 1	Total	45.99478346	Watts
						$q = (hA(T1-T2))$	
R=6.5024; r=4.4	R= 6.5024*10^-3; 4.4958*10^-3	31	24	304	297	101.227	Watts
21.844	0.021844	24	23	297	296	-0.1626726017	Watts
R=6.5024; r=4.4958		23	22	296	295	7.106840625	
		22	21	295	294	1.484061799	Watts
				System 2	Total	109.6552298	Watts
				System 1&2	Total	155.6500133	Watts

Appendix D: Pairwise Objectives Total

Objectives	Jimmy	Joe	Kristen	Mike	Totals	Order of Importance (Most to Least)
Aesthetics	0	0	1	0	1	Safety
Cost-Effectiveness	5	3	2.5	4	14.5	Functionality
Functionality	6	7	6	6.5	25.5	Efficiency
Efficiency	5	6	5.5	6	22.5	Practicality/Weight
Flexibility	2.5	2	1	1.5	7	Cost-Effectiveness
Safety	8	8	6.5	8	30.5	Ease of Use
Ease of Use	2	5	4	2	13	Flexibility
Practicality	4	4	3.5	5	16.5	Aesthetics
Weight	5	1	5.5	5	16.5	

Appendix E: LabView Vis Single Thermocouple VI

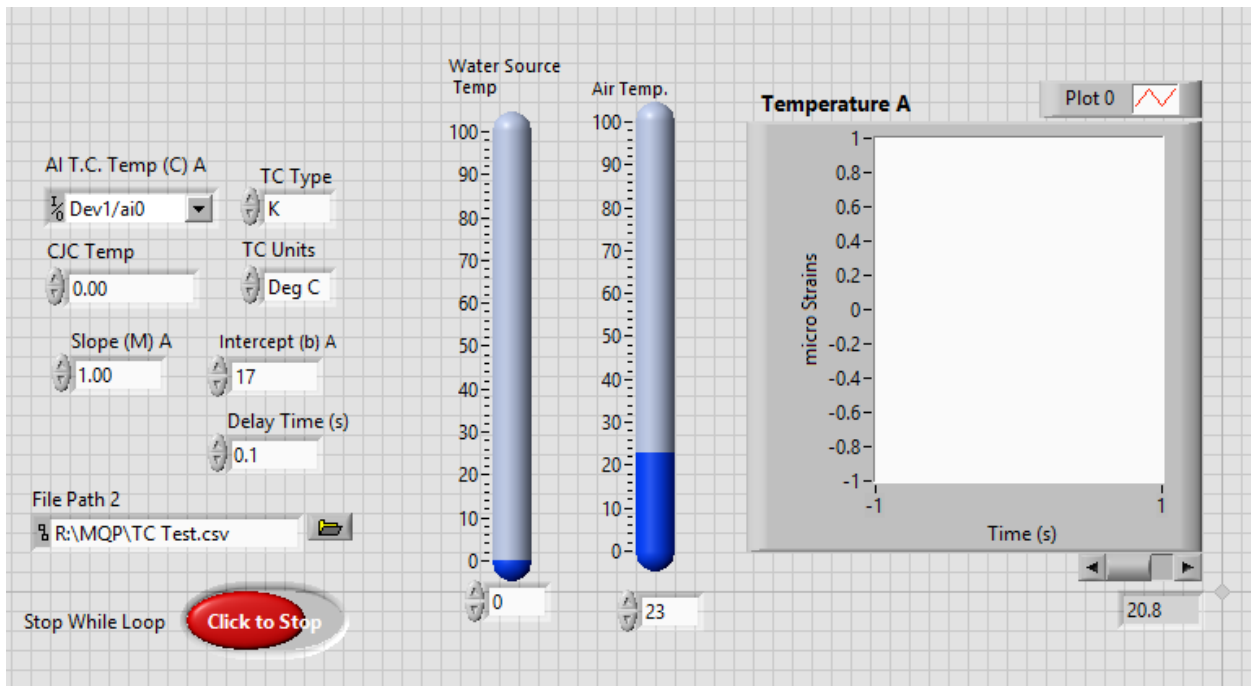
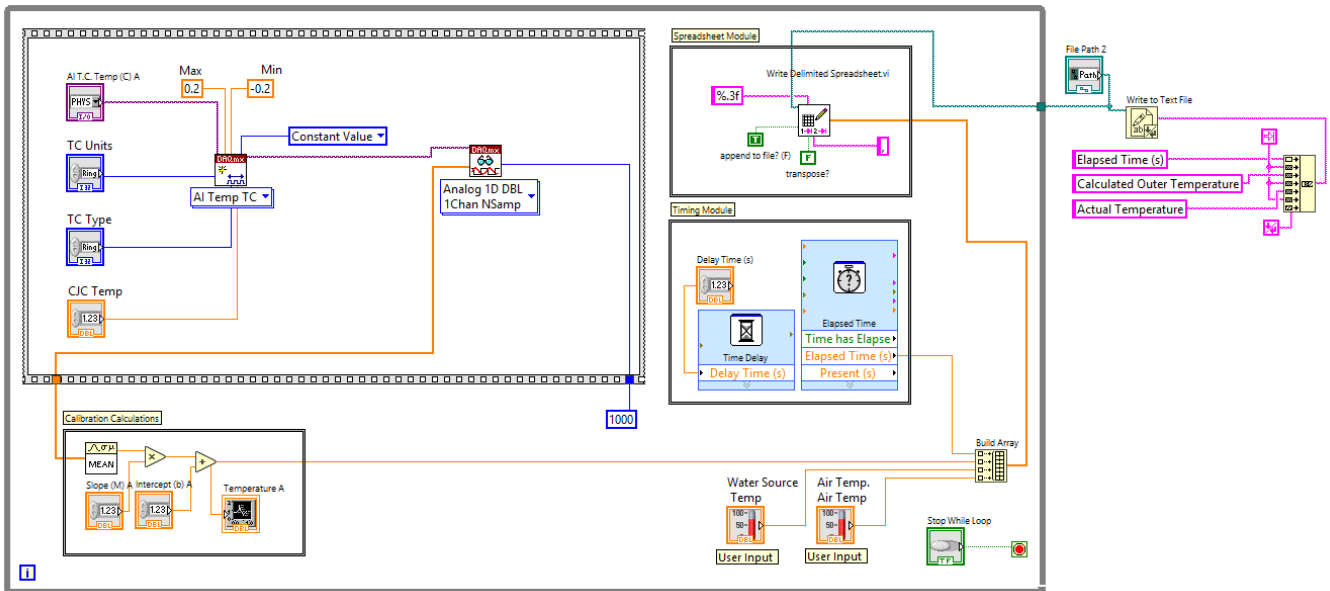

4 Thermocouple VI

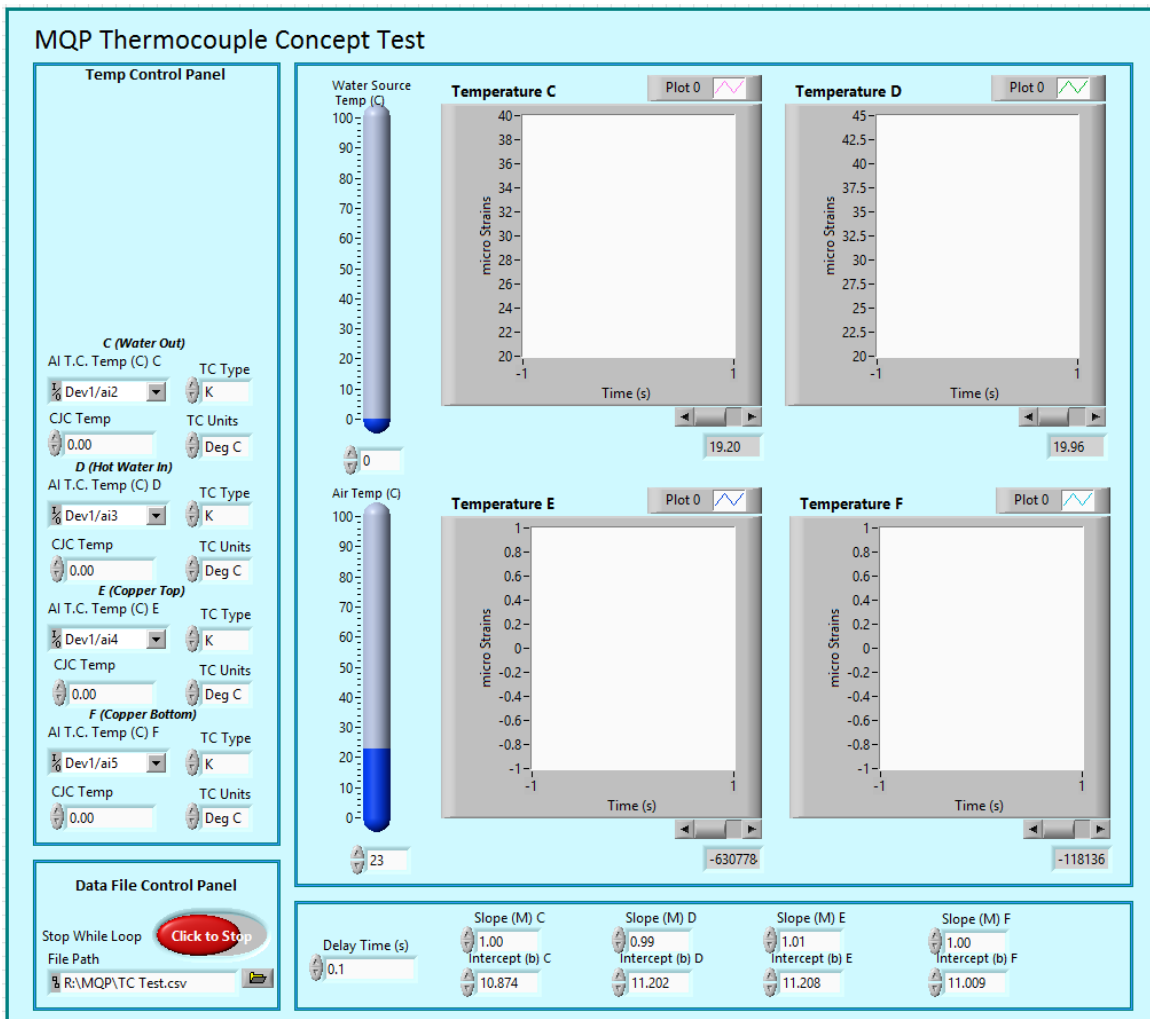
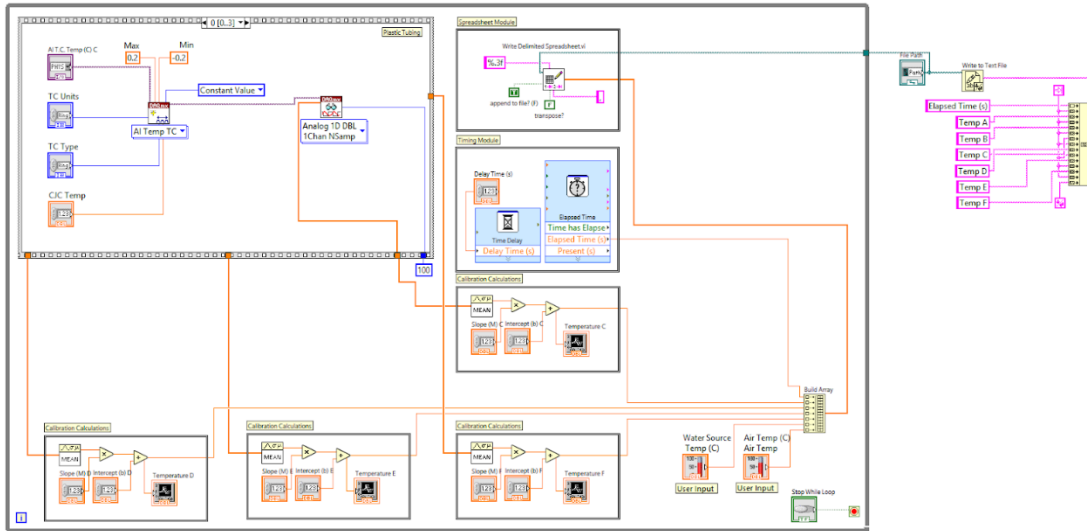

Full thermocouple test

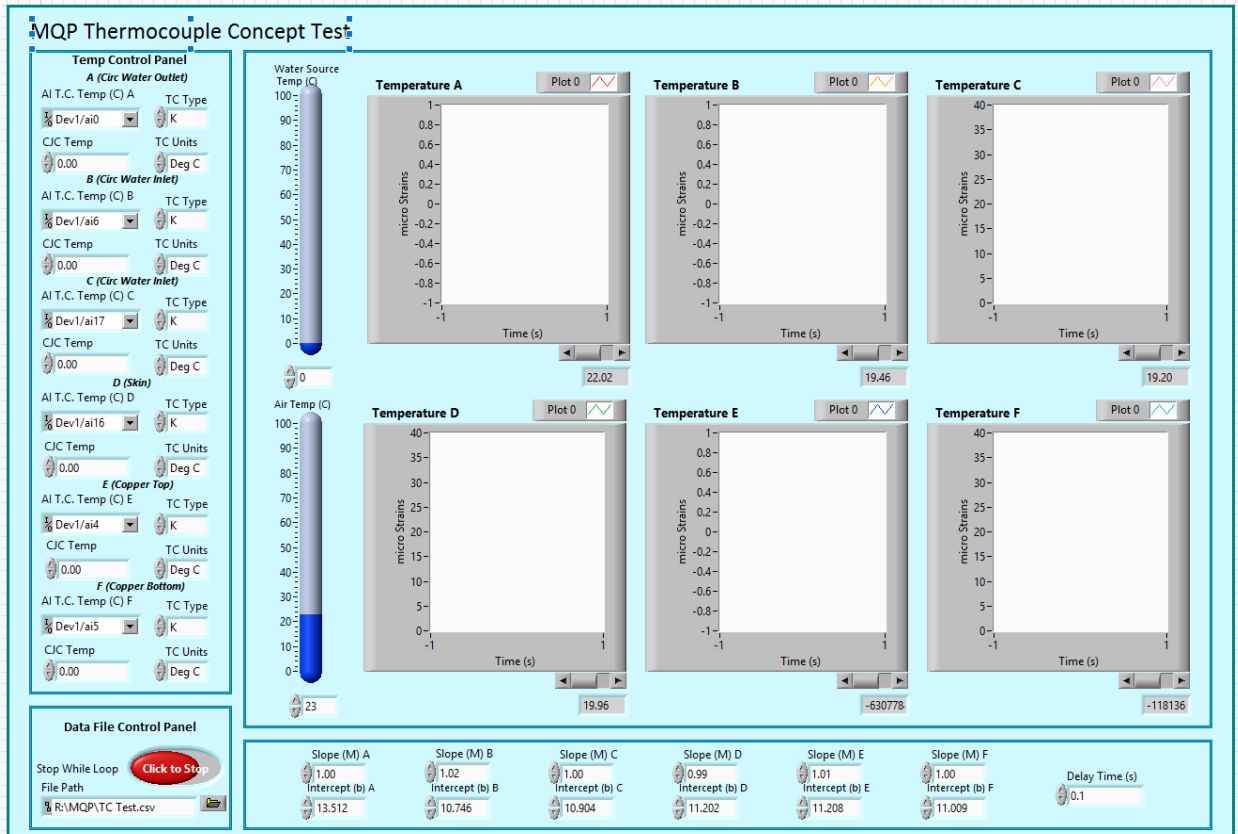
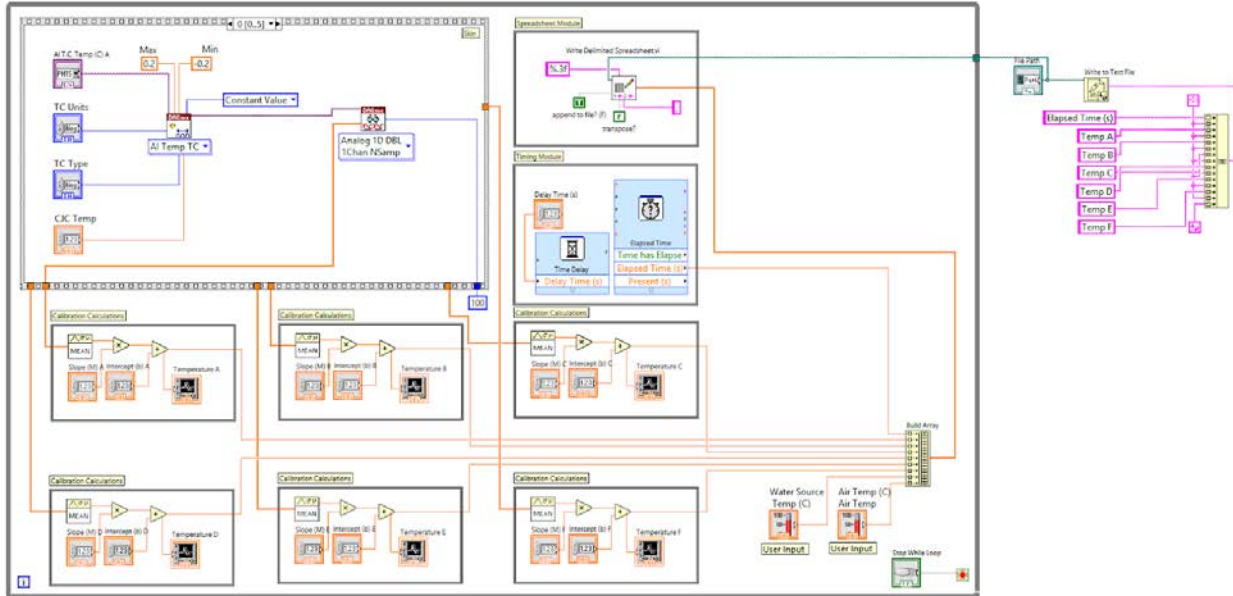

Evaporative Cooling Experiment

Purpose: To determine the effectiveness of the evaporative cooling system and quantify the results of the cooling process.

Materials:

- 4 Type K Thermocouples
- Evaporative cooling frame
- Evaporative cooling shirt
- Peristaltic Pump
- Body temperature water (37 C)
- Ice water (0 C)
- DAQ box
- Power Source capable of 12 V & 300 mA

Equipment:

- Small personal fan
- Hair Dryer with temperature controls

Procedure:

- 1) Obtain 3 Beakers of ice & a pot of water
 - a) Turn on hot plate to medium high and put pot on hot plate
 - b) Place the other 3 beakers next to the hot plate
- 2) Initialize Labview program
- 3) Setup prototype, materials, and data recorders
- 4) Lay T-shirt with tubing out
 - i) Position Evaporative Cooling frame upright to position in its intended fashion
 - ii) Connect Pump to power source
 - iii) Ensure brass and plastic connections along tubing
 - iv) Thermocouples
 - v) Calibrate thermocouples on the Labview program. This step is crucial in order to confirm the integrity of the data.

- vi) Thermocouples cold junction must be submerged in cold water pot
 - vii) Opposite ends of thermocouples attached to designated areas: copper tubes & microfiber sheet.
- 5) Insure the the hot water stays at $37C \pm 0.5$ degrees. This requires the constant pouring of ice into the pot.
 - 6) Place polyurethane tubing that runs to the inlet of shirt into hot water pot on hot plate.
 - 7) Close the needle valve attached to the tubing going back into the system to allow pump to build head pressure.
 - 8) Turn on Power supply to send voltage to pump to 12 V and 300 mA
 - 9) Open the needle valve attached to tubing in hot water pot.
 - 10) Start Labview program
 - 11) Once the system is full of water, close the needle valve attached to tubing in hot water.
 - 12) Run for 20 minutes
 - 13) While running experiment, insure that the water is always at the ideal temperature of $37C$ and constantly monitor so that ice can be used to equal out the hot water.
 - 14) Save data through Labview to a comma separated value (.csv) file and quantify data into graphs.

Designing Capability Statements to Win Federal Contracts

A Major Qualifying Report

Submitted to the Faculty of

Worcester Polytechnic Institute

In partial fulfillment of the requirements for the

Degree in Bachelor of Science for

Kristen Bender

Professional Writing

Mechanical Engineering Biomechanics Concentration

Project Number: JMS - 1802

Date: April 26, 2018

Project Advisor:

Professor Ryan Madan

This report represents the work of one or more WPI undergraduate students submitted to the faculty as evidence of completion of a degree requirement. WPI routinely publishes these reports on its web site without editorial or peer review.

Table of Contents

Abstract.....	88
Acknowledgements.....	87
Purpose.....	87
Background.....	88
Government Contracting Basics	88
Federal Acquisition Regulation	90
Government Purchase Processes.....	90
How Businesses Enter Contracting Cycles.....	92
Writing Aspects of Capability Statements	94
Research Questions.....	95
Methodology	95
Genre Analysis.....	95
Usability Review.....	97
Results.....	97
Genre Analysis.....	97
Usability Review.....	101
Conclusions and Recommendations	104
Capability Statements Samples.....	106

Abstract

Part of the lucrative nature of obtaining government contracts includes being knowledgeable about the process, which is a great opportunity to expand business endeavors, but may be difficult for small companies to become familiar with. Government contracting is a complex system of programs, codes and regulations. However, companies can leverage their strengths with the contract award process, specifically with documentation like the capability statement. Through analyzing these condensed capability statements, I investigated the best writing practices, and applied them by generating a mock-up statement for my mechanical team's self-sustaining ruck cooling system to be reviewed by local contracting officials. These findings provide inquiry into the contracting process as a whole and insight for businesses to enter the contracting process competitively.

Acknowledgements

I would like to thank Laura Robinson, Bruce Derksen, MaryAnn Pinto, Stuart Loosemore, and Grace Otta for their guidance and invaluable insight throughout this project. Last but not least, many thank you's to Professor Ryan Madan for helping direct and develop my project with the utmost patience over the past year.

Purpose

As the team's operational envelope and intended user is focused on military personnel, the government would be the central figure for the implementation of this self-sustaining ruck cooling device. Since government regulated products often have additional specifications and policies to meet, there are important considerations when fulfilling design objectives and parameters. If the team's device was implemented in military operations, it would need to be accessed through a federal contract award process. This portion of the project focuses on how the team, acting as a small new business, could engage in this process to expand growth and increase potential networking opportunities. Small businesses can benefit from entering the federal marketplace, however new contractors are frequently unprepared for the process of procurement.

While my mechanical team was designing the cooling system, we had to consider how the device would be utilized in the fleet. This aided in defining project constraints, but also sparked the thought process of how the device could actually be implemented in the future. With two team members heading into military service, I was familiar with the way the government awards contracts for military equipment, but wanted to learn how the team could pursue this option. The topic of federal contracting as a whole was far too large of a topic, but in order to even recognize that I had to understand how the government buys and allocates funds. How do large corporations vie for contracts? Is this the same process but a different scale for smaller businesses? Is it more important to rub shoulders with contracting officials to establish some sort of familiarity and history? Or does it not matter who you are? The more I dug, the more questions I had relating to my mechanical project. Could we go through the contracting process without a company sponsor? Would a patent be needed? Did the development of novel device design affect the contract? Although the team opted not to seek a patent or further implementation, I was intrigued by this

process and wanted to learn more about how a business would go about acquiring a federal contract.

The topic of government contracting is not frequently discussed in academia, whereas project grants are prevalent and considered the primary funding resources for research. However, great growth opportunities exist with federal contracts that are often overlooked. I aimed to bring attention to how the government purchases and the intricacies of all the systems involved, while engraining myself in the terminology and documentation. This parallels how a new business might educate themselves before attempting to attain a federal contract. With the lens of professional writing, I specifically wanted to see how documentation was impacting the process of federal acquisition. In a generally bland documentation system, I found that the design of the capability statement as an all-in-one, attention grabbing reference document made it a significant decision point in the contracting process. This single document became the focal point of the project; however its importance cannot be fully understood without first being aware of the federal procurement process as a whole, as the capability statement design is catered to the way contracting officials access and use them.

Background

In order for a business to be considered a legitimate competitor in the federal contracting field, it is necessary to be well versed in the procurement process. It is important to understand in depth the relationship between contracting entities in order to assess the role of documentation within this process, which will be the focus of the analysis.

Government Contracting Basics

The dynamic process of government contracting is composed of complex management systems and regulations. The United States federal government purchases a comprehensive range of commodities and services, but businesses must comply with all standards to even submit a bid for a contract award.

Opportunities in Contracting

Expanding into government contracting can increase networking and potential growth of a business. However, breaking onto the federal contracting scene can be intimidating due to perceived “red tape” and pure lack of knowledge regarding government processes.¹ Small businesses new to contracting may have particularly difficult times learning about the intricacies of various systems or dedicating the proper manpower necessary to become familiar with the process. Small businesses can particularly benefit from federal contracts, as these industries are the primary driving force for new competition and innovation. Economic growth depends more on the rate of new business formation than on the rate of existing business expansion.²³ Through

¹ Smotrova-Taylor, Olessia. 2012. *How to Get Government Contracts: Have a Slice of the \$1 Trillion Pie* Apress. <https://proquest.safaribooksonline.com/book/small-business-and-entrepreneurship/9781430244974>.

² Malecki, Edward J. and Edward J. Malecki. 1990. "New Firm Formation in the USA: Corporate Structure, Venture Capital, and Local Environment." *Entrepreneurship and Regional Development* 2 (3): 247-266.

³ Wennekers, Sander and Roy Thurik. 1999. "Linking Entrepreneurship and Economic Growth." *Small Business Economics* 13 (1): 27-55. <http://www.jstor.org/stable/40229031>.

bidding, private entities compete for public service production which can contribute to decreased costs and direct government involvement.^{4,5} In the framework of contracting, the government acts as a socially equitable business, meaning that all contractors hold equal competitive opportunity to vie for a contract award.⁶

For the past decade, the United States government annually awards contracts totaling around \$500 billion, as displayed in Figure 1.⁷ The top contractors are Lockheed Martin, Boeing, Northrup Grumman, General Dynamics, BAE Systems, Raytheon, and L-3 Communications.⁸ Although these defense corporations consume large contract awards, nearly a quarter of total federal contract funds are designated for small business use.⁹ “Set-asides” (contracts in the \$3000-150,000 range) are automatically reserved for small businesses.¹⁰ A small business is defined by its size standard, depicted by employee numbers of up to 500 individuals or average annual revenue of less than \$700 million.¹¹

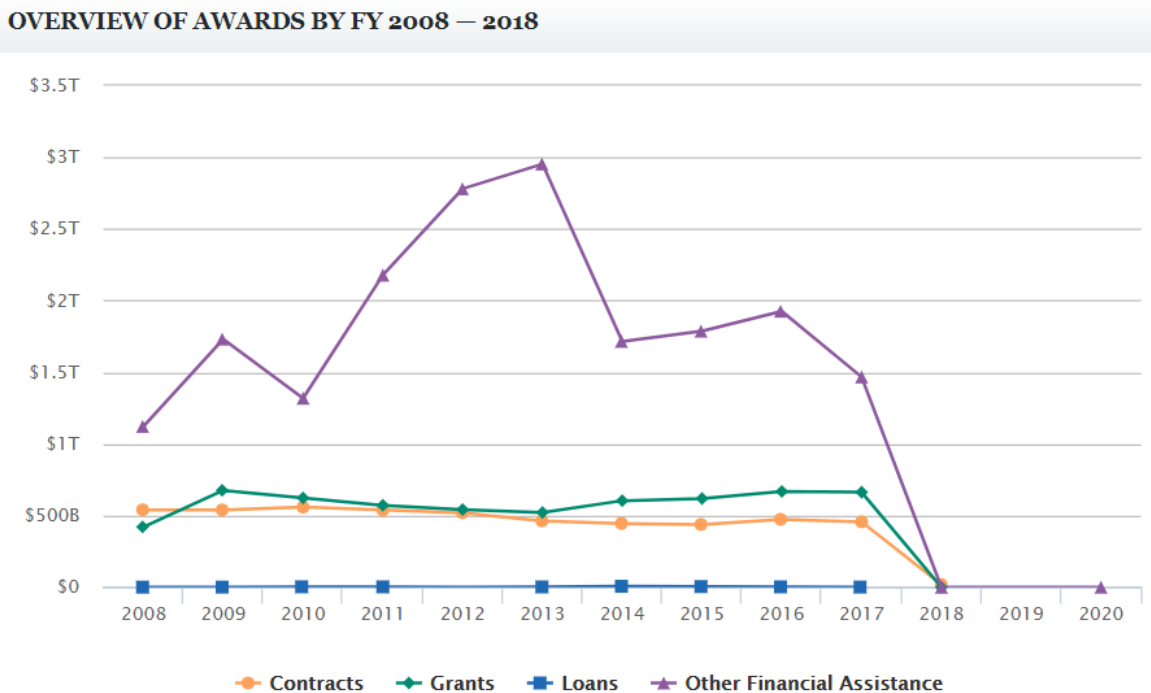

Figure 49: Federal Award Total Trends per Fiscal Year

⁴ Domberger, Simon and Paul Jensen. 1997. Contracting Out by the Public Sector: Theory, Evidence, Prospects Oxford Review of Economic Policy.

⁵ Savas, Emanuel S. 2000. Privatization and Public-Private Partnerships. New York: Chatham House. <https://trove.nla.gov.au/version/34818900>.

⁶ Denhardt, Robert and Janet Denhardt. 2002. The New Public Service: Serving rather than Steering. Armonk, New York: ME Sharp.

⁷ "US Government Spending Database." USAspending.gov., <https://www.usaspending.gov/>.

⁸ Ibid.

⁹ Hefetz, Amir and Mildred Warner. 2004. "Privatization and its Reverse: Explaining the Dynamics of the Government Contracting Process." Journal of Public Administration Research and Theory: J-PART 14 (2): 171-190. <http://www.jstor.org/stable/3525868>.

¹⁰ "Government Contracting 101 Part 1." 2015b.SBA.

¹¹ Ibid.

Defining Types of Contract Awards

The government structures the contract award process using a series of programs and organized codes. In order to acquire a successful contract award, businesses must comply with the myriad of regulations within each step of the bidding process, as defined by procurement authorities and associated departments.

Federal Acquisition Regulation

The primary authority and governing body of contracting is the Federal Acquisition Regulation (FAR), which directs all of the federal government's purchasing procedures and standards. FAR provisions outline how the government conducts purchases in order to maximize value and meet public policy objectives. If businesses new to contracting lack a strong comprehension of FAR, legal issues and loss of contracts may follow.

Government Purchase Processes

Before continuing to the documentation of contracting, it is necessary to discuss the ways the government can purchase goods and services, since each way has a different application process. There are five types of government purchasing defined by the FAR (as seen in Figure 2 in orange).

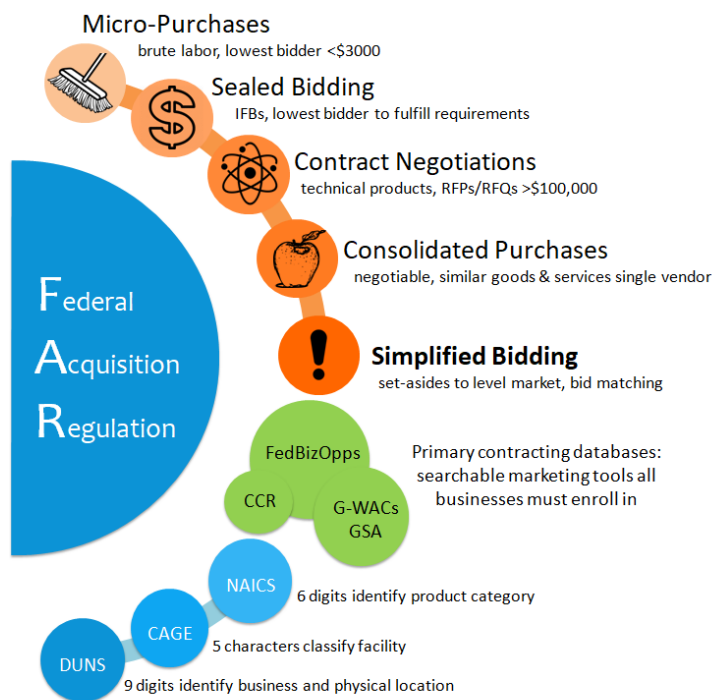

Figure 52: How the government buys (orange), what databases are used (green) and how a company defines itself (blue), all regulated by FAR

The government uses micro-purchases, simplified procedures, sealed bidding, contract negotiations and consolidated purchases to award contracts.¹² These five methods are the primary ways to secure a contract award. Although these processes are fairly well defined, it can be perplexing to navigate and negotiate the material involved in each, particularly if a business is small and still in a growing phase.

The most simplistic and “low level” contract is a micro-purchase. Micro-purchases are items less than \$3000 and do not require a bid and quote method. Alternatively, these small purchases can be processed with a credit card or government purchase card. Oftentimes, these purchases include brute labor such as janitorial work.¹³

The form of purchasing utilized by most small businesses is a simplified bid, which applies to purchases up to \$100,000.¹⁴ The Federal Acquisition Streamlining Act of 1994 reduced soliciting restrictions by decreasing

¹² "Government Contracting 101 Part 1."2015b.SBA.

¹³ Ibid

¹⁴ Ibid

documentation, approvals and administrative details. Purchases in the \$3000-100,000 range were determined as set-asides, unless two or more small firms are unable to provide competitive bids.¹⁵ Set-asides may be further specified for Veteran-Owned (SDVOSB) or Woman-Owned small businesses (WOSB).¹⁶ The government has established quotas for certain socio-economic groups that allow for greater opportunity for small businesses to enter in the market.¹⁷ Regardless, all contracts over \$25,000 must be publicly advertised on Federal Business Opportunities, FedBizOpps.¹⁸ This online database shows listings for a majority of government bid opportunities and is one of the most powerful tools in attaining contracts. FedBizOpps can be searched to find what the government has previously purchased and is actively announcing, making it an essential reference for companies just initiating the contract process. There are “Solicitation Search Agent” and “Bid Match” features that monitor and sort relevant opportunities.¹⁹ The extent of this project will focus on the intricacies of simplified bidding.

Sealed bidding is utilized when product requirements and purchase conditions are clearly defined. This method applies Invitation For Bid, an IFB, through FedBizOpps and the contract is awarded to the lowest bidder who can fulfill all requirements.²⁰

Contact negotiations often involve awards exceeding \$100,000 for a technical product. These negotiations involve a more time-consuming Request for Proposals (RFP) and Request for Quotation (RFQ) submission. An RFP outlines the service desired and asks prospective agencies to answer how the product request would be fulfilled at a determined price point. Alternatively, an RFQ is an inquiry for the potential of an agency to provide a service. The contract is not established until the government creates an offer and it is accepted. RFPs and RFQs are also searchable on FedBizOpps.²¹

Consolidated purchases centralize government purchasing power for similar goods and services to single vendors. Multiple awards can be scheduled using General Services Administration (GSA) Schedules and Government Wide Acquisition Contracts (G-WACs). Vendors can negotiate prices and terms for extended agreements.²²

¹⁵ Lauderdale, John C. 2009. *The Complete Idiot's Guide to Getting Government Contracts Alpha*. <https://proquest.safaribooksonline.com/9781101145463>.

¹⁶ "Government Contracting 101 Part 1."2015b.SBA.

¹⁷ Bender, Kristen. 2018b. *Background Phone Interview*. Mary Ann Pinto. Federal Contract Solutions.

¹⁸ "Government Contracting 101 Part 1."2015b.SBA.

¹⁹ Bender, Kristen. 2018b. *Background Phone Interview*. Mary Ann Pinto. Federal Contract Solutions.

²⁰ "Government Contracting 101 Part 1."2015b.SBA.

²¹ Ibid

²² Ibid

How Businesses Enter Contracting Cycles

Competitive contract markets are monitored through contract award systems and schedules. The lifecycle of a federal contract differs from a commercial contract due to the structured systems and additional qualifications. FAR maintains the government's contracting standards to ensure that all businesses enrolled in FedBizOpps, GSA or G-WACs systems comply with basic federal regulations. In general, the process of obtaining a contract is displayed in Figure 3 below.



Figure 55: Lifecycle of Obtaining a Contract

Figure 56: Chain of Communication with Contracting Officials Figure 57: Lifecycle of Obtaining a Contract

The planning and research phase requires the interested business to evaluate their potential and enroll in one of the government contract systems. A business should determine if they are ready to initiate a contracting process by fully educating their staff about the requirements and risks.

In order to enroll in a contracting system, the business needs to define itself using government terminology. This is accomplished through a series of codes and identification classifications. The North American Industry Classification System (NAICS) identifies a product category with a six digit number, but is not directly linked to the business. The Commercial and Government Entity (CAGE) code is a five character identification that classifies a facility. Dun & Bradstreet provide a DUNS nine digit number for all government contractors to identify a business and its physical location. If a business is attempting to win a Department of Defense (DoD) bid, the agency needs a Federal Supply Group code. All of this identifying information is shown on all contracting databases, such as FedBizOpps previously mentioned. Another database is the Central Contractor Registration (CCR), where government agencies can find prospective vendors. A business must be registered in CCR and update their CCR profile every year to maintain an active federal vendor status and win a contract award. The CCR contains all data on a business and can act as both a marketing tool and résumé. Beyond databases, in-person “matchmaking” sessions are regionally hosted by government procurement agencies to pair interested businesses to contracting officers.²³

²³ Gormley, Bill. 2016. "Government Contracting: Explaining the Process in 5 Steps." SBA: Industry Word.

Agencies such as the U.S. Small Business Administration (SBA) provide businesses with information, counseling and assistance throughout the contract. Procurement and Technical Assistance Centers (PTACs) are resource centers where staff can attend training sessions. If the business determines that it is in their interest to obtain a contract award, they can identify themselves through one of the contract systems. PTACs will then direct businesses to the appropriate contracting office, where administrative (ACO), procuring (PCO) and termination (TCO) work to draft and execute a contract to present to a contracting officer²⁴. The ACOs and PCOs are the primary readers of any submitted documentation before providing a recommendation to the contracting officer (CO).²⁵ The contracting officer is the only person who makes the final agreement, as directed by FAR:

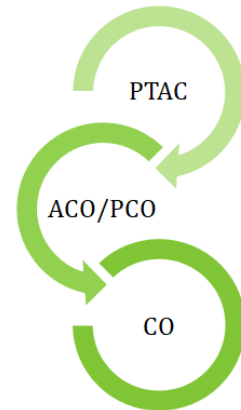

Figure 58: Chain of Communication with Contracting Officials

(a) Contracting officers have authority to enter into, administer, or terminate contracts and make related determinations and findings. Contracting officers may bind the Government only to the extent of the authority delegated to them. Contracting officers shall receive from the appointing authority...clear instructions in writing regarding the limits of their authority. Information on the limits of the contracting officers' authority shall be readily available to the public and agency personnel.

(b) No contract shall be entered into unless the contracting officer ensures that all requirements of law, executive orders, regulations, and all other applicable procedures, including clearances and approvals, have been met.

-Excerpt from part 1.602-1 of the FAR²⁶

This entire process is facilitated by outside communication. Despite the rigidity of the documentation of federal contract work, establishing the true drive and direction of an interested business is achieved by maintaining months of close communication with PCOs, ACOs and contracting officers. By solidifying a working relationship with a business, PCOs can recommend specific bids or support and affirm a proposal to a contracting officer.²⁷

²⁴ Dacuan, Lyndon. "Get to Know Key Government Contracting Personnel." GovWin+Onvia., <https://www.onvia.com/for-business/go-to-market-guidance/get-to-know-key-government-contracting-personnel>.

²⁵ Ibid.

²⁶ Federal Acquisition Regulation 2015a. Washington, D.C.: General Services Administration, Department of Defense.

²⁷ Bender, Kristen.. 2018b. *Background Phone Interview*. Mary Ann Pinto. Federal Contract Solutions.

Documentation: Capability Statements

Now that the contracting process and key players have been defined, the documentation can be delved into. A majority of the paperwork completed in the contracting process is online. The systems used to sort potential vendors categorize business information based on their various codes and identification classifications. In such a regulated, impersonal system, how can competitive businesses stand out from each other to earn the final contract award?

One of the few documents able to be personalized to impact award decision making is the “capability statement.” The capability statement is a concise document that outlines a business’ technical capabilities, performance history and management strengths. It can be service-based or product-based depending on what the business is aiming to supply.²⁸ The document may include logos and graphics to help distinguish the business brand and keep the reader intrigued. Ideally, this document should be no more than a page, but depending on the size and scope of the business, it could be extended as a pamphlet over several pages. Capability statements are a relatively select document format, used nearly exclusively for the federal contracting process.²⁹ Essentially, the capability statement parallels a résumé and is the first document that a contracting official will look at.

The capability statement is a qualifying document. Does this business hold pertinent certifications? Will they be able to meet production goals? Have their employees worked with federal contractors before? What credibility do they have within their field? It is a checklist of whether a business meets the contract requirements or not. The capability statement gets the foot in the door to facilitate further communication. If the business does not provide a high quality capability statement, they could immediately be passed over.

Writing Aspects of Capability Statements

Writing capability statements would be a simplistic task, if there was a verified formula for success. A capability statement should mimic the language and end goals of the contract award it is attempting to win. By evaluating the elements of writing and guidance from the SBA, two categories can be discerned: essential and optional, as summarized in Figure 5 below.³⁰

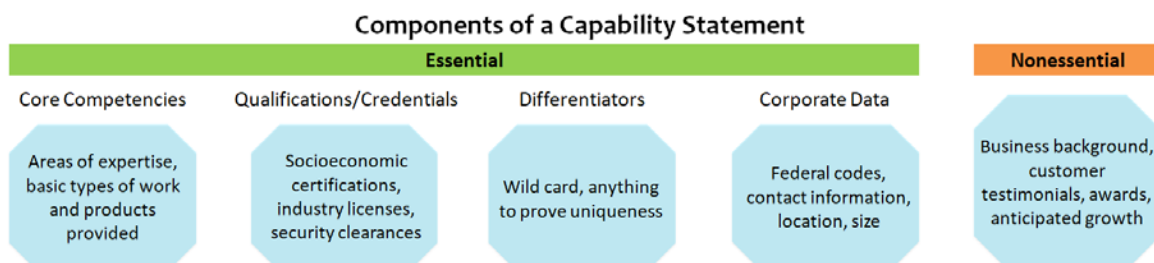

Figure 60: Capability Statement Components

²⁸ Matheson, Jesse. 2016. "Paperless Contracting: Contract Writing System Considerations for Government Entities Today and in the Future." Matheson, Jesse, 14-21.

<https://search.proquest.com/docview/1781637657/abstract/9A6D9A6CCD434701PQ/1>.

²⁹ Schabl, Chuck. "Capabilities Statements for Government Contracting." APTAC - Association of Procurement Technical Assistance Centers., <http://www.aptac-us.org/capabilities-statements-for-government-contracting/>.

³⁰ "Business Opportunities: A Guide to Winning Federal Contracts." a.SBA

Essential components are based on given requirements and reader's need. In this case, the readers are the ACOs and PCOs who are using this single page of information to determine whether a company could viably complete the contract with enough quality given the cost effectiveness³¹. The SBA indicates that the basic requirements of capability statements are: core competencies, qualifications/credentials, differentiators and corporate data.³² Core competencies define the company's areas of expertise and the basic types of work that relate to the contracting agency's needs. Qualifications and credentials are included to validate a business' socioeconomic certifications, security clearances, industry licenses and prove success on past performances. Differentiators help contracting officers separate bids from the crowd. This section needs to prove to contracting officers why they should pick a particular business over another similar service. Corporate data includes all codes and company information such as size, location and contact information. The pertinent codes include: DUNS, NAICS, CAGE, GSA numbers, BPAs, and credit or purchase cards. Optional components may include customer testimonials, past or current customer references, awards and business background.

Research Questions

Given this background information, I determined that the primary goal of this project was to investigate and understand the writing practices in federal contracting documentation and provide insight for businesses to enter the complex and lucrative contracting process competitively. The focus would more specifically be the documentation and communication involved with the government contracting process. My primary research questions are as follows:

- What primarily impacts the decision maker in federal contract awards?
- What are the best practices of businesses attempting to obtain a federal contract?
- At what point does documentation affect major decision-making?
- What role does the capability statement play?
- What literary strategies do successfully contracted businesses employ?

Methodology

I investigated a couple methods to assess the role, impact and success of the capability statement within a government contract setting. To properly address the research questions, I primarily employed a genre analysis followed by a modified usability analysis.

Genre Analysis

I evaluated the role of these capability statements within the contracting community through the lens of genre analysis. I began by familiarizing myself with contracting documentation by reaching out to federal contract firms. Since I was unable to access the databases as a single individual (not a registered business), I had to ask for resources that were considered successful by my points of contact. In this way, I classified specific document components while considering

³¹Bender, Kristen. 2018b. Background Phone Interview. Mary Ann Pinto. Federal Contract Solutions.

³² "Business Opportunities: A Guide to Winning Federal Contracts." a.SBA

the process and purpose of these features³³. Each of these literary components are tailored to the way information is accessed and used by contracting officials. The expectations of the contracting officials combined with the guidance of preexisting capability statements form a specific expected style and format.

Choosing Capability Statements

Eight capability statements were used as samples for this analysis. Each statement was drawn from a different technical specialty, from lab work to construction to information technology. Within the context of this project, the various parts of sample capability statements were evaluated in order to assess the impact of the statement as a whole. A short annotated example is shown below in Figure 6.

The image shows a screenshot of the Askew Industrial Corporation website's 'Capability Statement' page. The page is annotated with several callouts and arrows pointing to specific sections:

- Relevant header pictures:** Points to the top navigation bar and header images.
- Short introduction:** Points to the introductory paragraph about the company's inventory.
- Highlights main product line and specifications, almost too much detail:** Points to the 'CORE COMPETENCIES' section, which lists various nuts, bolts, studs, screws, and washers.
- Validation through prior contract work:** Points to the 'PAST PERFORMANCES' section, which lists contracts with the Dept. of the Navy, Defense Logistics Agency, and Defense Contract Management Agency.
- Personal POC, multiple contact methods:** Points to the contact information at the bottom of the page.
- Most referenced codes easy to reference location:** Points to the 'NAICS & PSC CODES' section.
- Repetitive, breaks space or acts as filler:** Points to the 'COMPANY SNAPSHOT' section.
- Quick reference information repetitive:** Points to the 'DIFFERENTIATORS' section.
- Claims experiences, reiterates quality, highlights company values:** Points to the 'DIFFERENTIATORS' section.
- Categorical codes labeled and defined clearly:** Points to the 'NAICS & PSC CODES' section.

Figure 63: Askew Industrial Corporation Capability Statement Annotations

Elements of visual rhetoric were considered along with the inclusion of essential and optional components. The genre analysis of sample capability statements provided insight into the expected standards and myriad of content presentation in the contracting community. In doing so, I acquired eight capability statements from different government services, evaluated recurring patterns or unique themes and identified how the elements reinforced or failed to reinforce the company's focus. From this analysis, I drafted a list of best practices.

³³ Garzone, Giuliana E. 2015. Genre Analysis. doi:10.1002/9781118611463.wbielsi069. <https://doi.org/10.1002/9781118611463.wbielsi069>.

Usability Review

The intent of this usability review was to identify how the contracting officers read in a corporate structure³⁴. Utilizing the list of best practices from the literary analysis, I constructed two versions of capability statements for the self-sustaining ruck cooling system from the perspective of the U.S. Army Natick Soldier Systems Center (NSRDC) in Natick, Massachusetts. In this hypothetical scenario, NSRDC is attempting to earn a federal contract for their recently patented ruck cooling system. This capability statement was taken to a Massachusetts PTAC office to be read by a contracting official. Each provided feedback separately and the best practices were either be proved or denied. Their reading criteria and concerns were discussed after as a contextual interview.

Results

Genre Analysis

The point of this approach was to examine the individual portions of a capability statement and identify how it is joined to generate a single deliverable. After annotating and evaluating each capability statement separately, I was able to draw several consistencies and a few unique points. The relative “success” of a company was deemed through evidence of other contract awards or news of a confirmed contract.

Core Competencies

The core competencies section of the capability statement was presented in one of three ways: sections, bulleted phrases or single paragraph. Core competencies should tell the contracting officer what goods and services the company can provide as a quick reference, not an in depth list. Seven of eight capability statements (all expect for Mediaforce) directly labeled “Core Competencies” before delving into more details. Four of eight sectioned their abilities out and then put more specific details as bulleted phrases. This allows contracting officers to skim the major capabilities and focus on their intended project objective if it applies. This was most clearly represented with Askew, as seen in Figure 7, where the primary product: nuts, bolts studs, screws and washers are bolded and below the alternative specifications and options are displayed. Dnutch utilizes a similar layout but visually blocks off the compartments of their capabilities by grouping Independent Verification, Information Assurance, Enterprise Infrastructure and Intellectual Property services separately, all under the

CORE COMPETENCIES

- **Nuts, Bolts, Studs, Screws, & Washers**
- Full Lot Traceability
- In-house Quality Control Inspection Laboratories
- Custom Packaging per Contract Specifications
- Vendor Managed Inventory VMI

Certified to All NAVY Specifications

- MIL-S-1222H
- MIL-DTL-1222J
- MIL-B-857
- FF-S-85E
- NASM25027
- MIL-N-25027
- ANSI
- NICU
- NICU-AL
- ASTM
- SAE
- QQ-N-281
- QQ-N-286

Level One Sub-Safe Nuclear Propulsion

Specials & Standards Off-the-Shelf:

- Mil-Spec
- Commercial Products
- K500 Monel
- 405 Monel
- 400 Monel
- 625 Inconel
- 718 Inconel
- 304-316-347 Stainless Steel
- Grade 2, 5 and 8
- Grade B7, 7, 4, B8, B8M, BM, B16
- CHROM-MOLY

Figure 66: Askew Industrial Corporation Capability Statement Excerpt

³⁴ Assistant Secretary for Public Affairs. "Usability Evaluation Methods." Usability.gov. Department of Health and Human Services, last modified -10-09, <https://www.usability.gov/how-to-and-tools/methods/usability-evaluation/index.html>.

header of Core Competencies, displayed in Figure 9 below. A lot of content is provided in this section, but the reader is still able to focus on the sections pertinent to the contract at hand. Less effective core competencies sections used either a single paragraph or multiple bulleted paragraphs, as with GES in Figure 10 and Premier in Figure 8. This cluttered the capability statement as a whole and I found myself avoiding reading the entire block of text, which contained important information. The Premier and Askew capability statements both appeared to use the same font and title block design, further illustrating the direct importance of the way text based information is portrayed. The GES sample also includes very small and unlabeled pictures and diagrams that are perhaps intended to convey a point but instead merely act to waste or break up the space. The key takeaways from this portion of the capability statement is that streamlined, sectioned bullet points best allow the reader to skim and be selective without missing important information on the type of work a company does.

CORE COMPETENCIES	
<ul style="list-style-type: none"> • Auto Repair - We provide a large spectrum of repairs from light to heavy duty repairs. We offer, engine, transmission, suspension, brakes, and electrical repairs. We also conduct tune ups, oil changes, and factory scheduled maintenance based specifically on the vehicle make and model to guarantee a proper service. 	<ul style="list-style-type: none"> • Auto Body/Collision Repair - We have a fully certified automotive paint booth with all brand new top of the line equipment to guarantee extremely high quality results. Our auto body repair and painting will leave your vehicles with a factory finish.
<ul style="list-style-type: none"> • Preventative Maintenance - On every vehicle that enters our facility we conduct a 27 point inspection to make note of any emergency repairs required immediately and to keep track of possible repairs which may be needed in the future. By doing this we identify repairs needed in advance and keep track of them to minimize vehicle downtime and maximize vehicle reliability. 	<ul style="list-style-type: none"> • Pickup and Delivery - We provide a pickup and delivery service to save our customers time and to make our services more convenient for our customers. We have a Semi and trailer to allow us to pick up and drop off multiple vehicles at once which will in turn provide you with a quicker turn around.
<ul style="list-style-type: none"> • Auto Detailing - After every service each vehicle is washed and detailed in order to be returned in a cleaner than received manner. 	

Figure 69: Premier Racing Services and Repair Capability Statement Excerpt

CORE COMPETENCIES	Independent Verification & Validation <ul style="list-style-type: none"> ❖ SW Development Lifecycle Assessment ❖ Project Management Lifecycle Assessment ❖ Software Quality Assurance ❖ Software Architecture Reviews ❖ Technical Oversight 	Information Assurance <ul style="list-style-type: none"> ❖ Information Security ❖ Business Rules for Security ❖ Systems Architecture ❖ Certification & Accreditation ❖ Cross-Domain Security 	Enterprise Infrastructure Design & Development <ul style="list-style-type: none"> ❖ Network Architecture & Planning ❖ Software Design & Implementation ❖ Network Integration, Interoperability & Performance ❖ Network Management ❖ Systems Integration
	Products and Intellectual Property <p>Dnutch also leverages its core skill set to develop intellectual property and products. We employ these in the conduct of our work and we sell them as turnkey products. An example includes our SimSuite™ and CDAT™ product, a comprehensive network simulation and security validation platform.</p>		

Figure 72: Dnutch Associates Inc Capability Statement Excerpt

Core Competencies

Government Energy Solutions, Inc. (GES) provides energy intelligence, energy control, and optimized systems engineering solutions to the U.S. Federal and State Governments. The company leverages information technology and energy methodologies to provide expert analysis, products and solutions through the use of hardware and software, and integrated managed services to the Government energy market sector, both CONUS and OCONUS, Government sites and customer sites.

Figure 75: GES Capability Statement Excerpt

Qualifications/Credentials

The qualifications and credentials are a very simplistic portion of the document due to the nature of the content, but are often considered as a checklist of whether or not a company meets expected criteria. Qualifications and other credentials were listed as acronyms and variably included a logo or additional visual as verification. It is important that companies do not leave off valid credentials, as they may shortchange themselves. Prevalent credentials included SDVOSB, WOB, and professionally imperative memberships, as seen in Figure 11 on the next page in an excerpt from Agathos Laboratories. This company heavily employed logos as additional validation, but the poor formatting

CERTIFICATIONS



➤ **CERTIFIED DBE/SBE**
040713 (10/1/17)



➤ **CERTIFIED SB/MB**
173114 (4/30/17)



➤ **CERTIFIED MBE**
13040068 (5/30/16)



➤ **CERTIFIED WBE**
Pending

PROFESSIONAL MEMBERSHIPS

- ACS
- SLAS
- AACC

detracts from its effectiveness. The qualifications that are deemed relevant enough to be placed on the capability statement should be significant to both the company and the desired contract. Nearly all companies provide some form of credentials, but it is important to note that unless a contracting officer is close to the company, they will not know if any certifications are missing. Particularly in government contract work, security clearances and highlighting set-asides can give a company clout and a more competitive package. This section would be difficult for small businesses that are new to contracting since they may not have the accolades and longevity of membership. This time stamp shouldn't be taken into great account, but it is natural for contracting officers to lean towards a company with greater history and proof of professionalism rather than risk the lack of experience. As noted by Worcester Regional Chamber of Commerce's Director of Government Affairs and Public Policy, Stuart Loosemore, with capability statements, "qualifications give flexibility" since a contracting officer needs to decide if the business is prepared for the contract job and is worth federal funds. As a general rule of thumb, the more qualifications and credentials a business holds, the more the contractor can use each as a reason why a certain business fits the job.

Differentiators

Differentiators are the most persuasive portion of the capability statement and are intended to convince a contractor to pick a certain business. This section had the most variance across the board. Half labeled the section "Differentiators" while others used "Corporate Summary/Profile/Expertise" to explain why their business was unique. This did not appear to be any more meaningful one way or the other, it just contributed to the level of formality and focus of the contents within that section. Some used bullet points to emphasize experience or explain the business' motto, while others explained the history or described the work environment and past customers through a paragraph. Of all the essential information on a capability statement, this is the most

CA Board of Chiropractic Examiners (BCE)	Department of Defense (DOD) – Delaware National Guard	Anne Arundel Dept. of Social Services	CA Dept. of Corrections & Rehabilitation (CDCR)

Figure 76: Agathos Laboratories Capability Statement Excerpt

personalized. The business can portray their strengths as they see fit, whether it be the success of their product, people or past.

Interestingly enough, patents provide a unique fast track in the contracting world. If the government wants to capitalize on a new product concept with a patent, they will bypass the standard capability statement considerations according to MaryAnn Pinto, a Business Consultant and Lawyer with Federal Contract Solutions, LLC who specializes in government, commercial, and global contracts and compliance. After twenty years in the field, she asserted that contracting officials will pursue these new companies with patents that otherwise would not be considered. This is a special circumstance that would apply to the mechanical team's self-sustaining ruck cooling system if a patent were pursued.

Corporate Data

Corporate data, which includes the company's contact information, address and any relevant point of contact, is a fairly straightforward section due to the nature of the information. The business needs to decide if a generic contact method is provided or if specific individuals are noted, depending on their job and relevance to the contract. Although a CEO might be important, the head of procurement may be a more useful point of contact for contractors. Giving an exact name and number for an individual gave a more personal feel to the service and automatically gives contracting officials an "in".

Best Practices

By looking at the success of the sample capability statements, a few consistencies were identified as follows:

- Clean, readable formatting with a simplistic color scheme and logo
- Contains all "essential" elements in some form:
 - Core competencies, qualifications/credentials, differentiators, corporate data
- Labeled or "call-out" sections for quickly and commonly referenced information
- Minimal text without removing or skimping on pertinent information
- Relevant, high- quality figures, diagrams, images

Usability Review

Applying Best Practices

In order to apply and determine the validity of these best practices, mock-up capability statements were generated from the perspective of the U.S Army Natick Soldier Research, Development and Engineering Center (NSRDEC) attempting to obtain a contract for their services. This research and development group is composed of engineers, designers and scientists who provide a wide range of capabilities to improve combat products and overall systems. Their mission is to improve current technology employed by soldiers through input from data collection and direct feedback in order to maximize “survivability, sustainability, mobility, combat effectiveness and field quality of life.” Although NSRDEC would not be involved in the simplified bidding process (since they are already a government entity, they would likely receive the contracts), previous research they had conducted directly aligned with my mechanical team’s self-sustaining ruck cooling system. I generated two versions of capability statements for the NSRDEC that contained similar information, but brought up different focuses.

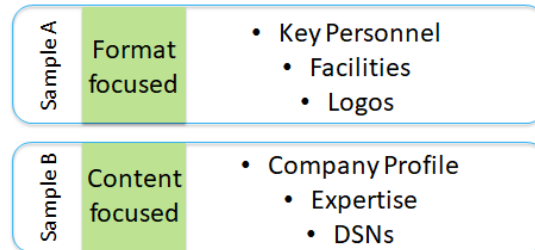

The first one, Sample Capability Statement A, I focused on formatting, labeling and limiting text. I created a single paragraph explaining the goals of NSRDEC as a differentiator and the remaining information was provided in bullet point phrases. The core competencies were broken down into emphasized sections and slightly more detailed sub-sections. All company data was included in the upper right corner to hypothetically allow a contracting official to flip through papers for key information quickly if it were printed, or if it were online, would not need to scroll down to find necessary codes and contact information. I decided to test a “Key Personnel” as a form of validation and humanizing the document by using an individual’s name. The logos at the bottom of the page were meant to validate the document as well as the “Facilities” section to showcase the project opportunities of the research center.

In my second attempt, Sample Capability Statement B, I focused on content over layout. This resulted in more blocks of paragraph text in an attempt to personalize and validate the company. Rather than using the traditional headings, I broke down information into Company Profile, Expertise, Core Competencies and Company Data. Instead of mentioning all testing facilities, I included the database source name (DSNs) for each research group division.

I anticipated that the contracting official will prefer the layout and core competencies of Sample A, but appreciate the additional information and perspective provided in Sample B. Both samples are shown on the following pages.

Capabilities Statement



Differentiators

Everything at NSRDEC focuses on supporting the Soldier: maximizing survivability, sustainability, mobility, and combat effectiveness in a research, development, testing and evaluation setting. This unique relationship with the Soldier gives NSRDEC insight into their real-world operational experiences and provides the ability to address urgent needs as they happen in the field. The goal is to empower the world's most capable fighting force in whatever way possible, today and into the future.

Core Competencies

- **Early Applied Research**
 - Product development, collaborations
- **Clothing and Protective Equipment**
 - Uniform modifications
 - Adaptive, mobile, usable
 - PPE: eyes, hands, feet, body
- **Airdrop/Aerial Delivery**
 - Supply packaging, parachute design
- **Combat Nutrition**
 - MREs, rations, cooking equipment
- **Expeditionary Movement**
 - Concealment, camouflage, decoys
- **Human Systems Integration**
 - Field performance testing
- **Small Combat Unit Technology**
 - Integrating new equipment

Company Data

Contact:

Office of Research and Technology
nsrdecinfo@mail.mil
508-223-4184

DUNS#123456789

CAGE# 5WJK4

NAICS Codes:

541330, 541380, 541715, 928110,
311999, 336992, 339999, 448190

Key Personnel:

BGen Vincent Malone, CO
www.nsrdec.mil

Facilities

Cognitive Performance Laboratory
Doriot Climatic Chambers
Oullette Thermal Test Facility
3D Laser Scanning Laboratory



Certifications

SDVOSB
HubZone (SBA)
DoD Mentor

Recent Projects

- Load limiting and quick drying shoe
- Environmentally responsive exoskeleton
- *Patent pending* for self-sustaining rucksack cooling system





Company Data

NAICIS

541330, 541380,
541715, 928110,
311999, 336992,
339999, 448190

DUNS#123456789

CAGE# 5WJK4

DSNs

Aerial 256-4495
Food 256-4670
Move 256-4347
Protect 256-4827

Certifications

SDVOSB
HubZone (SBA)

Meets all US
Army Specs

Contact:

Office of Research and
Technology

www.nsrdec.mil

nsrdecinfo@mail.mil
508-223-4184

Technology Driven, Soldier Focused

Company Profile

The U.S. Army Natick Soldier Research, Development and Engineering Center (NSRDEC) is located at the U.S. Army Natick Soldier Systems Center in Natick, Massachusetts, under the Army's Research, Development and Engineering Command. Stretching back to 1954, the NSRDEC's history of support for the Soldier has continued uninterrupted for more than six decades, with a focus on Soldier-related research, development and testing and evaluation efforts. If Soldiers wear it, eat it, sleep under it, or have it airdropped to them in theater, it can be traced back to the NSRDEC.

Made up of a diverse workforce comprised of scientists, engineers, technologists and equipment designers, the NSRDEC provides a wide range of capabilities to the Soldier, to include field feeding and life support systems, clothing, precision airdrop systems, and ballistic, chemical and laser-protection systems.

Expertise

NSRDEC employs a group of NCOs as human resource volunteers and are able to offer invaluable insight for implementation in the field. In 2018 alone, researchers have optimized upper leg exoskeletons to decrease fatigue, converted biomass excess for emergency food, created a boot to limit tibial injuries and are working to patent a self-sustaining ruck cooling system for hot, arid combat zones.

Core Competencies

In NSRDEC's extensive facilities, such as the Cognitive Performance Laboratory, we focus on applying research to collaborative product developments. We actively seek projects concerning:

- **Clothing and PPE**
- **Airdrop/Aerial Delivery**
- **Combat Nutrition**
- **Expeditionary Movement**
- **Human Systems Integration**
- **Small Combat Unit Technology**



Feedback

PTACs

To complete the usability review, I contacted the local PTAC in search for any contracting officials to review my sample capability statements. All the Massachusetts PTAC offices for Statewide, North Shore, Boston and Central affairs are located at University of Massachusetts at Amherst. Their purpose is to provide new business owners (who have less than two years of experience in the field) with free assistance through the Massachusetts Small Business Development Center Network.

I contacted Grace Otta, the Procurement Analyst for the Western Massachusetts area, who promptly responded to my initial emails, however her schedule did not allow adequate time for her to provide me any form of feedback on the capability statements. She did say that she was “excited to hear that your senior thesis...is on government contracting / analyzing capability statements” which I thought was intriguing since their offices are located on a college campus. It is somewhat surprising, but validates my initial thought that the academic community does not get involved with federal contract work and would instead pursue grants.

Conclusions and Recommendations

The intention of this project was to investigate the process of federal contract work. The role of writing capability statements is akin to a resume: it legitimizes the company and pushes their foot in the door, so to speak. As long as the capability statement contains pertinent information that is organized to appease federal officials and does not shortchange any opportunities provided by the business, then it should be reasonably effective. Although the government is viewed as a slow behemoth, the contracting work completed needs to efficiently dole out funding and purchasing power to best serve the public. Contracting officials need to be able to quickly determine the value of a company’s product based on the contracting paperwork provided. The careful process of government procurement lends itself to the design of capability statements as a referential, yet attention grabbing, quick access document in an otherwise bland paperwork procedure. If a company does not abide by this format, then they run the risk of losing the contract award competition.

Part of the lucrative nature of obtaining government contracting is being knowledgeable about the process. Before starting this project, I had never encountered any in depth information regarding federal contract work in any context. I was intrigued by the prospect of government contract work, but quickly found that the knowledge was relatively constrained to those involved. The overarching difficulty of this project was ingraining myself in the procedural steps and terminology, a similar challenge businesses new to the contracting field face. A company will be better set up for success by fully utilizing all the resources provided to them and referencing experienced other companies within their field. If a company were entirely new to the process, they should ensure that their sales department is well informed about the intricacies of the various programs and codes and ensure that the company stays up to date on any certifications. As with any specialty field, professionals utilize their own systems and terms. For government work, that means acronyms for everything. Ideally, this training could be conducted by attending online Learning Center courses through the SBA and other government programs. Another method would

be to acquire a mentor through PTACs or the DoD. There are companies who are dedicated to guiding new businesses through this learning process, but their expense may not be feasibly “worth it.” The business itself needs to be its own best advocate.

This project opens the gate to future research into the communications of contract work outside of the structured processing. This could include the translation of a deal through the means of email, phone calls, in person meetings and matchmaking sessions. Other projects could look into the different contracting processes businesses face based on their size and product line.

It is important to look into the intricacies of federal contracting because of its greater implications and opportunities available. By taking advantage of the funding provided through federal purchases, businesses (and consequently the economy) can prosper with greater certainty at dedicated price points. The contracting system is not currently being taken advantage of due to a lack of knowledge about the process, which could be remedied by business’ awareness of current programs in place, along with mentorship and a willingness and patience to learn.

Capability Statements Samples

Agathos



CAPABILITY STATEMENT

CERTIFICATIONS



➤ **CERTIFIED DBE/SBE**
040713 (10/1/17)



➤ **CERTIFIED SB/MB**
173114 (4/30/17)



➤ **CERTIFIED MBE**
13040068 (5/30/16)



➤ **CERTIFIED WBE**
Pending

PROFESSIONAL MEMBERSHIPS

- ACS
- SLAS
- AACC

NAICS CODES

541380, 621511
424210, 621999

AGATHOS LABORATORIES, INC

SUPPLIER ID # 1738114 // CBE # C3465683 // DUNS # 078358549 // CAGE CODE 6N1S4
// EIN 90-0785179 // BTRC# 000283373200010

OUR PEOPLE

- Dominique Neely, CEO (dneely@agathoslabs.com)
- Paul Momoh, PhD, President (pomomoh@agathoslabs.com)
- Rachel Barsotti, Reg. Dir. of Operations (rachel.barsotti@agathoslabs.com)

CONTACT US

EMAIL: quotes@agathoslabs.com // **WEB:** www.agathoslabs.com
PHONE: 408-730-6819 (Office) // 888-699-0445 (Toll-Free) // 408-246-5227 (Fax)
ADDRESS: 5201 Great America Pkwy, Suite 320, Santa Clara, CA 95054

CORPORATE PROFILE

Agathos Laboratories, Inc. (ALI) is a national provider of drug, alcohol and steroids testing as well as routine and esoteric medical testing services. ALI was incorporated as a C-Corporation in 2012 by the State of California and is a certified Small Business. Unlike our competitors (large or small), we offer our clients not one but a multiple of major testing laboratory brands to service their needs. All laboratories have their strengths and weaknesses so when you choose a single laboratory; you get all it comes with – “the good, the bad, and the ugly.” By choosing ALI you only commit to the BEST of laboratory services. Our business model is predicated on real competition between labs for the sole benefit of our clients. ALI’s focus on the economic and efficient management of laboratory testing services coupled with our excellent customer service and attention to detail sets us apart from the competition. We aim to exceed your expectations. Since its inception, ALI has been awarded multiple federal, state and local government contracts.

CORE CAPABILITIES

- DOT and non-DOT Drug, alcohol testing services
- Random test selection and telephonic notification
- Scheduled and Emergency drug and alcohol testing services
- Routine and esoteric medical testing services
- Onsite, off-site and after-hours specimen collection and testing services
- Drug-free workplace plan development, implementation and administration
- Sales of Rapid drug screening devices

CA Board of Chiropractic Examiners (BCE)	Department of Defense (DOD) – Delaware National Guard	Anne Arundel Dept. of Social Services	CA Dept. of Corrections & Rehabilitation (CDCR)
------------------------------------------	-------------------------------------------------------	---------------------------------------	-------------------------------------------------



Askew Industrial Corporation

Cage Code: 5A195 | Duns #: 028452035

ASKEW



Capability Statement

www.askewindustrial.com

Founded in 1957 Askew Industrial stocks the largest shipyard-specific inventory of nuts, bolts, studs, screws and washers in multiple locations strategically located throughout the country. We are especially proud to have a very large inventory of domestic and DFAR materials. All our materials meet US Navy specifications.



CORE COMPETENCIES

- Nuts, Bolts, Studs, Screws, & Washers
- Full Lot Traceability
- In-house Quality Control Inspection Laboratories
- Custom Packaging per Contract Specifications
- Vendor Managed Inventory VMI

Certified to All NAVY Specifications

- | | | |
|-----------------|---------------|------------|
| • MIL-S-1222H | • NASM25027 | • ASTM |
| • MIL-DTL-1222J | • MIL-N-25027 | • SAE |
| • MIL-B-857 | • ANSI | • QQ-N-281 |
| • FF-S-85E | • NICU | • QQ-N-286 |
| | • NICU-AL | |

Level One Sub-Safe Nuclear Propulsion

Specials & Standards Off-the-Shelf:

- | | |
|-----------------------|-----------------------|
| • Mil-Spec | • 718 Inconel |
| • Commercial Products | • 304-316-347 |
| • K500 Monel | • Stainless Steel |
| • 405 Monel | • Grade 2, 5 and 8 |
| • 400 Monel | • Grade B7, 7, 4, B8, |
| • 625 Inconel | • B8M, BM, B16 |
| | • CHROM-MOLY |

COMPANY SNAPSHOT

Government Business POC: John R. Horton
 Phone: 323-201-4024 | Fax: 323-372-3727
 Email: jhorton@askewindustrial.com
 Address: 13071 Arctic Circle Santa Fe Springs, CA 90670
 Work Area: Global

DIFFERENTIATORS

- Over 100 years of marine & shipyard industry experience
- Certified To All NAVY Specifications
- ISO 9001:2008 Quality Management System
- Marine Applications (Military/Commercial)
- Same-day Shipping
- Fastest Quote turnaround time in the Industry
- Service - Strive to provide the highest level of client service
- Quality - Meet/exceed the quality requirements of our clients
- Value - Provide best overall value to our clients
- Integrity - Uphold integrity in all of our dealings with each other, with our clients, suppliers and other entities with which we interact
- Respect - Treat every single member of the Askew team with respect
- Professionalism - Maintain professionalism in all our dealings

PAST PERFORMANCES



Dept. of the Navy
 # of Contracts: 52 Contracting Actions
 Top Office: NAVSUP Weapon Systems Support
 Details on FPDS.gov: [Navy Contracting History](#)



Defense Logistics Agency
 # of Contracts: 20 Contracting Actions
 Top Office: DLA Maritime - Norfolk
 Details on FPDS.gov: [DLA Contracting History](#)



Defense Contract Management Agency
 # of Contracts: 1 Contracting Actions
 Top Office: DCMA Santa Ana
 Details on FPDS.gov: [DCMA Contracting History](#)

NAICS & PSC CODES

- 423710 Hardware Merchant Wholesalers
- 5305 Screws
- 5306 Bolts
- 5307 Studs
- 5310 Nuts & Washers



John R. Horton
 Government Business POC

www.askewindustrial.com
 323-201-4024

jhorton@askewindustrial.com
 13071 Arctic Circle Santa Fe Springs, CA, 90670



CAPABILITIES STATEMENT

DUNS# 143133754
CAGE# 4TZWS

CERTIFICATIONS

SDVOSB (CVE Verified)
WOB
HUBZone (SBA)
DBE: Virginia, Texas,
Louisiana, Maryland

NAICS CODES

PRIMARY
236220 Commercial Construction
238390 Rough Carpentry
238390 Doors, Fixtures, Hardware
238390 Furniture
238310 Drywall
238330 Flooring

BONDING

\$20m per/\$40m aggregate

OFFICE LOCATIONS

Dumfries, Virginia
New Orleans, Louisiana
San Antonio, Texas

KEY PERSONNEL

Amber Peebles, President
Melissa Schneider, VP
Clay Froom, COO
Sheila Henderson, CAO

CONTACT INFO

Athena Construction Group, Inc.
18031 Dumfries Shopping Plaza
Dumfries, Virginia 22026

703.221.7131 office
703.221.7929 fax

www.athenaconstructiongroup.com
info@athenaconstructiongroup.com

COMPANY SUMMARY

Athena Construction Group is the oldest, largest and most respected SDVOSB, WOB, HUBZone construction company in America. We specialize in General Contracting and self-performing the installation of Doors, Frames and Hardware and Drywall. Widely acknowledged for our integrity and ability to complete complex difficult projects, Athena is the company of choice for federal agencies, large General Contractors and private clients.

With significant federal experience our staff has in excess of 100 years of construction expertise. Combined, our professionals speak six different languages, have multiple degrees in engineering, and have OSHA 30, USACE CQM, ASHE, ICRA and LEED certifications.

We are proud to have Hensel Phelps as our Mentor in the DoD Mentor Protégé program.

CORE COMPETENCIES

Rough Carpentry
Interior Build-out
Furniture Supply & Installation
Painting
Doors, Frames, Hardware & Installation
Light Commercial Construction
Highway Work

CORPORATE EXPERTISE

Following is a list highlighting some of our accomplishments to date:

PROJECTS

FEDERAL CLIENTS

- Walter Reed Medical Center
- VA Healthcare, VA Cemetery
- DHS, St. Elizabeth's
- ICC-B
- Ft. Belvoir Community Hospital
- Pax River
- VA Audie Murphy
- POFB Federal Building
- Canon House Office Building
- Camp Pendleton Naval Hospital
- WWII Memorial
- National Museum of the Marine Corps

PRIVATE CLIENTS

- Baker Daniels
- Blank Rome LLP
- Epstein Becker Green
- Frederick Community College
- George Mason University
- Raytheon



DUNS: 039274555; **CAGE CODE** 1T3M5; **CERTIFICATIONS:** SBA 8(a), SDB, WOSB, SDVOSB, EDWOSB, MBE, DBE, WBE; **FACILITY:** TS CLEARANCE

Dnutch Associates Inc. was founded in 1993 by a core of expert software and network engineering professionals. As a company, we have successfully made the transition from the commercial sector to the state, federal, and defense sectors. Today, we provide technical services, management, and products; within the domains of software development, network infrastructure, and enterprise applications integration. We provide valuable leadership and support to companies and government programs where leading-edge technology solutions are mission-critical.

Dnutch employs a holistic and disciplined technical and management approach to the IT program lifecycle. Our approach emphasizes best practices, quality and cost-efficiency. Moreover, programs and tasks are managed by a senior staff of subject matter experts that average 20 years of experience. Our goal is to provide best-in-class solutions, products, and services of the highest quality; and to deliver significant value to our customers so that we earn their respect and loyalty. Dnutch Associates Inc. maintains offices in Massachusetts and a business development office in Washington, D.C.

CORE COMPETENCIES		
Independent Verification & Validation	Information Assurance	Enterprise Infrastructure Design & Development
<ul style="list-style-type: none"> ❖ SW Development Lifecycle Assessment ❖ Project Management Lifecycle Assessment ❖ Software Quality Assurance ❖ Software Architecture Reviews ❖ Technical Oversight 	<ul style="list-style-type: none"> ❖ Information Security ❖ Business Rules for Security ❖ Systems Architecture ❖ Certification & Accreditation ❖ Cross-Domain Security 	<ul style="list-style-type: none"> ❖ Network Architecture & Planning ❖ Software Design & Implementation ❖ Network Integration, Interoperability & Performance ❖ Network Management ❖ Systems Integration
Products and Intellectual Property		
<p>Dnutch also leverages its core skill set to develop intellectual property and products. We employ these in the conduct of our work and we sell them as turnkey products. An example includes our SimSuite™ and CDAT™ product, a comprehensive network simulation and security validation platform.</p>		

NAICS		MARKETS SERVED/SELECT CLIENTS	
541512	Computer Systems Design Services	Commercial	<ul style="list-style-type: none"> ❖ 3Com ❖ Alcatel/Lucent ❖ Intel ❖ Parsons PTG ❖ Parsons Brinckerhoff ❖ Cisco ❖ Fidelity ❖ IBM ❖ Raytheon
541511	Custom Computer Programming Services		
518210	Data Processing, Hosting, and Related Services		
541519	All other Computer Related Services		
541490	Other Specialized Design Services		
541690	Other Scientific and Technical Consulting Services	State/Federal Government	<ul style="list-style-type: none"> ❖ MTA/NVCT ❖ DHS ❖ FAA ❖ DOT Defense <ul style="list-style-type: none"> ❖ US Army ❖ US Air Force ❖ US Navy (SPAWARS) ❖ US Air National Guard
541710	Scientific Research and Development Services.		

CONTRACT VEHICLES: ESC/PASS (Air Force/DOD); GSA Alliant SB GWAC, GSA IT Schedule 70, GSA 8(a) STARS II (GSA); Seaport-E, SPAWAR (Navy/DOD)

Dnutch Associates, Inc. 13 Branch Street, Suite 208, Methuen, MA 01844, **Web:** www.dnutch.com
President and CEO: Ms. Denise Jones, **Phone:** 617-448-9971, **Email:** djones@dnutch.com
Sales: Roosevelt Thomas, **Phone:** 703-798-4936, **Email:** rthomas@dnutch.com
Office: 978-687-1500 **Fax:** 978-6870-1540

Government Energy Solutions Capabilities Statement

Core Competencies

Government Energy Solutions, Inc. (GES) provides energy intelligence, energy control, and optimized systems engineering solutions to the U.S. Federal and State Governments. The company leverages information technology and energy methodologies to provide expert analysis, products and solutions through the use of hardware and software, and integrated managed services to the Government energy market sector, both CONUS and OCONUS, Government sites and customer sites.



Services / Solutions

- Energy Management Systems Integration
- Meter Data Management Systems
- Information Technology Integration
- Network Engineering and Architecture
- Data Management and Mining
- Program and Project Management
- SharePoint Web Portal Development
- Process Flow Engineering
- Meter Data Management System Administration
- Systems Testing and Evaluation
- Building Automation Systems interfaces
- Dashboards / Report Generation

Company Data

DUNS: 961958761 | CAGE: 61EB9 | NAICS: 541330, 541360, 541380, 541511, 541512, 541513, 541519, 541614, 541620, 541690, 541712, 517911, 517919, 518210, 611420 | PSC's: AC1-7, AC21-27, AC61-67, Ad21-27, AG21-27, AG51-57, AG71-77, AG81-87, AG91-97, AJ11-17, AJ21-27, AJ41-47, AR71-77, AR91-97, AZ11-17



GES Annual Revenue

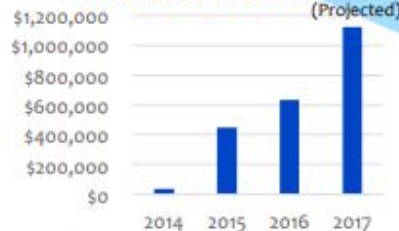

Management

The GES management Team consists of seasoned professionals who have launched and built start-up companies, and bring significant knowledge and experience delivering managed services to the federal Government, who have gained extensive experience designing, testing, deploying and integrating core managed services, software energy control, management systems and data collection devices. Company leadership has a combined 100+ years with Government support contracting experience, leading network and facilities systems design and implementation.

Differentiators

GES has the ability to rapidly respond to the growing energy needs of the Government. GES's SMEs have proven past performance in leveraging technology to provide actionable capabilities that provide the Government customer visibility into their optimized energy consumption. This information becomes vital to saving energy, and reducing costs. GES also offers SharePoint web portal management services for our customer on-site at the Redstone Arsenal. A Certified Energy Manager is available for customized and optimized energy performance, and most personnel are Security+ certified.



Contract Vehicles

- ARMY CORPS of ENGINEERS Meter Data Mgmt. System**
Contract Number W912DY-14-D-0076 (GDIT sub)
- AMCOM EXPRESS Contracts**
Contract Number W31P4Q-05-A-0031 (SAIC sub)
Contract Number W31P4Q-09-A-0018 (Radiance sub)
Contract Numbers W31P4Q-18-A-0001, 0016 (AMS sub)
- ALLIANT Small Business GWAC**
Contract Number GS-06F-0625Z (enGenius sub)
- DEFENSE ORDINANCE TECHNOLOGY CONSORTIUM**
Contract Number W15QKN-14-9-1001 (GES Prime)
- SANDIA NATIONAL LABORATORIES**
Contract Number 1575408 (GES Prime)
- ARMY CONTRACTING COMMAND - NATICK DIVISION**
Contract Number W91OY-15-D-0104/0009 (Avatar sub)



515 Sparkman Drive, Huntsville, AL 35816 | 256-778-1437 | www.govesi.com | info@govesi.com

MEDIAFORCE
ADVOCATES FOR POSITIVE CHANGE

MediaForce, LLC, a woman-owned small business, is an award-winning communications agency specializing in public awareness campaigns for government agencies, nonprofit organizations and educational institutions. The firm produces and distributes integrated programs that utilize a mix of traditional, new media and social marketing tactics to change consumer thinking, drive behavioral change and provide a dialogue with target audiences.

PSN (The Public Service Network) is MediaForce's nationwide media network created exclusively for government, nonprofit and education sectors. PSN provides low-cost, guaranteed delivery and prime positioning of public service content using both traditional and unconventional channels.



Distribution Channels

MediaForce offers PSA distribution to 170,000+ outlets nationwide and growing.

- **PSN Entertainment:** PSAs delivered through digital networks, online ticketing, live entertainment at concerts and sporting events and through live tour marketing.
- **PSN In-Store:** PSAs over in-store audio network at 32,000+ grocery and pharmacy stores nationwide; guaranteed hourly placement.
- **PSN Pharma:** Print PSAs packaged with prescription drugs at 18,000 pharmacies nationwide; guaranteed delivery.
- **PSN Radio:** Customized distribution and placement of video PSAs on targeted radio networks.
- **PSN TV:** Customized distribution and placement of video PSAs on targeted TV and cable networks.
- **PSN WaitingRoom:** Reaching up to 323,500 physicians, 120,000+ medical offices and 194 million annual patient visits through either print or video.
- **PSAbank:** A radio network of more than 3,000 English and Spanish stations that have opted in to receive PSA content on a regular basis.

Contract Vehicle	NAICS Codes		
AIMS Schedule 541 GS-07F-0547U	512110	541511	541840
	512191	541613	541850
	512240	541810	541870
DUNS 186503640	512290	541820	541910
	541430	541830	541930
CAGE Code 47WN7			

CAPABILITY STATEMENT

MediaForce Services

- Strategic Communications Plans
- Audio/Video/Print Production
- Public Awareness/Education Campaigns
- Branding
- Sponsorship Development
- Partnership Development
- Multicultural Outreach
- PSA Production and Distribution
- Web Development
- Social Media
- National Media Buying
- Specialty Distribution Services (via PSN)

Government Client Examples

Agency for Healthcare Research and Quality (AHRQ)

Developed a pilot audio podcast, AHRQ's Healthcare 411, and used it to create an integrated communications network for syndicating content across multiple platforms. Tactics include English and Spanish video/audio PSA production, PSN In-Store point-of-purchase distribution, media tours, podcasting, comprehensive Web development, marketing and media tracking.

U.S. Customs and Border Protection (CBP)

Developed and managed multiple simultaneous national campaigns for CBP to educate consumers and motivate behavior. Tactics included advertising strategy, integrated campaigns, national media buys (airport dioramas, in-flight magazines/PSAs, PSN In-Store), audio PSAs, brand development, Web sites, marketing and metrics.

Food and Drug Administration (FDA)

Developed and launched multi-media public education/information campaigns. Tactics included PSAs across print/video/audio, national media buys (PSN In-Store, PSN Pharma, PSN WaitingRoom), marketing and metrics.

Additional U.S. Government Clients Include:

- HHS - National Institutes of Health
- HHS - Centers for Medicare and Medicaid Services
- DoD - Defense Threat Reduction Agency
- DOJ - Office of Justice Programs
- DOJ - Drug Enforcement Agency

Additional Clients Include:

- Wounded Warrior Project
- American Red Cross
- Volunteers of America
- National Public Radio

PREMIER

RACING SERVICES & REPAIR

Premier Racing Services and Repair LLC

We are a Combat Veteran owned and operated auto repair and auto body shop. We provide affordable, reliable, and high quality automotive repair and preventative maintenance that is above the common standard at a rate below the average cost. Integrity, loyalty, and quality are the standard by which we operate.



CORE COMPETENCIES

- **Auto Repair** - We provide a large spectrum of repairs from light to heavy duty repairs. We offer, engine, transmission, suspension, brakes, and electrical repairs. We also conduct tune ups, oil changes, and factory scheduled maintenance based specifically on the vehicle make and model to guarantee a proper service.
- **Auto Body/Collision Repair** - We have a fully certified automotive paint booth with all brand new top of the line equipment to guarantee extremely high quality results. Our auto body repair and painting will leave your vehicles with a factory finish.
- **Preventative Maintenance** - On every vehicle that enters our facility we conduct a 27 point inspection to make note of any emergency repairs required immediately and to keep track of possible repairs which may be needed in the future. By doing this we identify repairs needed in advance and keep track of them to minimize vehicle downtime and maximize vehicle reliability.
- **Pickup and Delivery** - We provide a pickup and delivery service to save our customers time and to make our services more convenient for our customers. We have a Semi and trailer to allow us to pick up and drop off multiple vehicles at once which will in turn provide you with a quicker turn around.
- **Auto Detailing** - After every service each vehicle is washed and detailed in order to be returned in a cleaner then received manner.

COMPANY SNAPSHOT

Government Business POC: Samuel Najac
 ☎ **Phone:** (863) 268-5620
 ✉ **Email:** premierracingservices@gmail.com
 📍 **Address:** 2807 Orient Road, Tampa, FL 33619
 ➔ **Socio-Economic Factors:** Minority Owned, Veteran Owned Small Business
 📍 **Work Area:** Central Florida
Cage Code: 7KHS9 | **Duns #:** 080171014

DIFFERENTIATORS

- Combat Veteran Owned and Operated
- 11+ Years of Experience
- Pickup and Delivery Service
- Automotive Technicians who are ASE (Automotive Service of Excellence) Certified

NAICS & PSC CODES

811111 General Automotive Repair
 811112 Auto Exhaust System Repair
 811113 Auto Transmission Repair
 811118 Auto Mechanical & Electrical Repair & Maintenance
 811121 Auto Body, Paint & Interior Repair & Maintenance
 811191 Auto Oil Change & Lubrication Shops
 811198 All Other Auto Repair & Maintenance

**Most Experienced
 Veteran Owned Auto
 Repair Shop in the Area**

Samuel Najac
 Government Business POC
 (863) 268-5620
premierracingservices@gmail.com
 2807 Orient Road, Tampa, FL 33619



CAPABILITY STATEMENT

Judith Manchester, President and CEO **Ed Schmitt**, Senior Vice President
 978- 828-3717 903-466-1654
 Fax: 978-759-0285 Fax: 978-759-0285
 jmanchester@UGSmedicaldental.com eschmitt@UGSmedicaldental.com

Core Competencies

Unimed Government Services, LLC (UGS Medical/UGS Dental/UGS Animal Health) is a certified Woman-Owned Small Business with extensive experience providing Dental and Medical Equipment and Casework, Custom Dental Project Solutions and Best-In-Class Infection Control Technology for Human and Animal Health. Our goal is to become your first and best resource.

- **Experience.** Our staff has over 55 years of Dental/Medical equipment and Industry Sales and Contract Negotiation experience and over 20 years of Medical Products and Management Consulting experience
- **Focused on Your Needs.** We are a business dedicated to serving the needs of government agencies
- **Custom Solutions.** We specialize in finding the products you need for your medical, dental and animal health facilities
- **Large Product Offering.** We have partnered with the world's finest manufacturers to provide a wide variety of high quality as well as innovative medical, dental and animal health equipment, products and solutions

Award Contracts & Past Performance

Contract Awards

V797P-3177M/ VA258-16-J-2879 VA Phoenix,
 Arizona Equipment for new Dental Clinic
 V797P-3177M/ VA258-16-J-2843 VA Phoenix, Arizona
 Cabinetry/Millwork for new Dental Lab
 VA247-16-C-0110 VA Tuskegee, Alabama Dental Lab
 Casework
 W6QK ACC-APG Natick, MA Planmeca Imaging
 Equipment
 W91YTZ-11-P-0737 West Point Dental Renovation- Custom
 Cabinetry
 VA Eugene, Oregon VA-15-P-260-3462 Dental Equipment
 VA Montgomery, Ala. VA247-15-P-1653 Dental Equipment
 VA Minneapolis, Minn. 618-A60103 Filter Systems
 VA West Haven, CT VA241-16-P-0356
 GSA Global Supply Contract BPA-GS-07F-QUGSV
 W901UZ-16-P-0007 Bismarck/ Planmeca Imaging Equipment
 DFAS LIMESTONE Contract FA-3016-12-P-0061
 DLA # SPE2DS-15-M-D554, DLA # SPE2DS-15-M-D555
 Indian Health Services HHSI246201400676P
 Nevada State Contract 083 00000057272
 New Mexico State Contract 21-000-00-00017
 Minnesota University Contract B11624.20115, B11624.10231

Differentiators

- Small Business Partners with leading equipment manufacturers
- Dedicated Government Sales
- Skilled in Major Renovation and Construction
- WBENC certified WOSB
- Experienced in multi-faceted Government Contracts
- Credits cards, purchase cards, FEDPAY and ETF/EDI accepted. WAWF-registered
- GSA Contract GS-07F-348AA
- ECAT Contract SPM2DH-13-D8221
- DAPA Contract SP0200-13-H-0020
- Products available on GSA Advantage
- Fast product shipment

Company Data

Established 2010, Certified Woman Owned
 Small Business
UGSmedicaldental.com



Certifications and Codes

Certified WBE and WOSB by the Women's Business Enterprise National Council (WBENC). Certification number: W110048 and 2005118551. **DUNS:** 965690857 - **Case Code:** 67MK2 - **NAICS Codes:** 325611, 325612, 334510, 334517, 334516, 337127, 337211, 337214, 339112, 339113, 339114, 339115, 339950, 423450, 423460, 423490, 423840, 423850, 424210, 424990, 541661
Unimed Government Services, LLC dba UGS Medical/UGS Dental/UGS Animal Health • 21370 Heywood Avenue,
 Lakeville, MN 55044