

*Envisioning Endlovini:
Options for Redevelopment in Monwabisi Park
Cape Town, South Africa
December 18th, 2008*





WPI students returning to the Indlovu Centre after a tour of the park during the first week.

Envisioning Endlovini: Table of Contents

AUTHORS AND AKNOWLEDGEMENTS	PAGES 3-5
<i>Overview of authors, advisors, sponsors, and other acknowledgements</i>	
CHAPTER ONE: THE INTEGRATED PLAN.....	PAGES 6-51
<i>A plan for redevelopment that combines the work of all six WPI project teams and sponsoring organizations</i>	
CHAPTER TWO: MAPPING FOR SPATIAL REDEVELOPMENT.....	PAGES 52– 72
<i>An overview of the current and desired social and geographical features of Monwabisi Park</i>	
CHAPTER THREE: BUILDINGS: PLACES FOR WORK, HOME, AND COMMUNITY	PAGES 73-97
<i>An overview of current building conditions and building options for redevelopment</i>	
CHAPTER FOUR: WATER AND SANITIAION.....	PAGES 98-134
<i>An overview of current water and sanitation conditions and plans for a new approach to service provision</i>	
CHAPTER FIVE: ENERGY SERVICES.....	PAGES 135-157
<i>A overview of current energy habits and options for safer, sustainable energy sources</i>	
CHAPTER SIX: ECO-ECONOMY REDEVELOPMENT	PAGES 158-190
<i>An overview of current economic conditions and options for implementing incremental, sustainable development</i>	
CHAPTER SEVEN: COMMUNICATIONS.....	PAGES 191-198
<i>An overview of communication and community involvement within Monwabisi Park</i>	

AUTHORS' NOTE

Envisioning Endlovini:

Options for Redevelopment is a resource created to give people a unique insight into the community of Monwabisi Park, Cape Town, South Africa. This book was written by twenty-two students from Worcester Polytechnic Institute, in fulfillment of the University's Interactive Qualifying Project (IQP) requirement. The students worked closely with the Shaster Foundation and other project sponsors and the Monwabisi Park community to complete this research. The authors intend for the readers of this

book to gain an inside look into the uniqueness of the Monwabisi Park community and to see the great opportunities for growth and sustainable redevelopment.

In the Fall of 2008, the WPI Cape Town Project Centre (CTPC) experimented with a unique and untested approach to how students traditionally complete IQP reports. The Cape Town Project Centre sponsored six projects that focused on the sustainable redevelopment of Monwabisi Park. Each of the six projects within Monwabisi Park investigated a different aspect of sustainable redevelopment. The projects focused on urban planning and mapping, communication, wa-

ter and sanitation, energy, buildings, and the economy. The complementary projects allowed students to collaborate on a project-centre wide level.

Instead of writing individual reports the six project teams worked together to combine everyone's research, analysis, and recommendations into this single collaborative document. In the writing of this collaborative document the authors made formatting choices that are much different than the traditional IQP report. *Envisioning Endlovini* uses text, charts and pictures in a wide, five-column layout. This format allows the authors to show in a more impactful and compelling mode the key obser-



and findings that resulted from the student's work. *Envisioning Endlovini* consists of an opening chapter called the "Integrated Plan" and six other chapters, which describe each of the aspects of redevelopment that the WPI projects studied. Each chapter consists of an overview of the current conditions in the community and a detailed plan for creating and implementing a particular aspect of redevelopment.

The intentions of this collaborative document were to present the information from all of the teams in a mode that reflects input from and benefits the community and the sponsors. However, as this kind of collaborative writing and formatting had never been used

across IQP teams there were many challenges that the project teams needed to confront. It is important to note that *Envisioning Endlovini* is the first attempt at widespread Project Centre collaboration in writing and presentation. This document will be continually edited and revised by future WPI students who travel to the CTPC. This work is just a start to addressing the issues of Informal Settlements. There is still much to be learned as this work has only scratched the surface of understanding community desires needs, and strengths.

The CTPC Director Scott Jiusto will lead future work at the WPI CTPC. For more information please contact sjiusto@wpi.edu.

Authors and Acknowledgments

2008 Edition: The first edition of this report was completed in December 2008 by the following WPI students who participated in the 2nd year of the WPI Cape Town Project Centre program. The report has been planned as a living document, with future students, faculty and others contributing to its evolution, including publication and potentially sales in various formats. The authors hereby transfer all rights of ownership of the report to the WPI Cape Town Project Centre with the stipulation that any future proceeds must go toward supporting the broad goal of sustainable community redevelopment in informal settlements.

WPI Project Advisors:

Scott Jiusto, *Assistant Professor of Geography, WPI Interdisciplinary and Global Studies Division, Director, WPI Cape Town Project Centre*

Robert Hersh, *Research Assistant Professor, WPI Interdisciplinary and Global Studies Division*

Mapping Team: *Debra Franck, William Mayo, Matthew Tomasko and Yanxuan Xie*

Sponsor: *City of Cape Town, Violence Prevention Through Urban Upgrading Programme - Alastair Graham*

Acknowledgments: The mapping team would like to thank Basil Tommy and Alastair Graham, and their respective organizations, the City of Cape Town and Violence Prevention Through Urban Upgrading, for offering their assistance as key partners in this planning process. We would also like to thank Di Womersley of the Shaster Foundation, Buyiswa Tonono, and the entire community of Monwabisi Park for welcoming and tremendously helping us. Finally, we would like to thank our tireless advisors, Scott Jiusto and Bob Hersh for having faith in our abilities to complete this project.

Buildings Team: *Dan Garcia, Tim Kunyz, Stephanie Schultz and Laura Tracy*

Sponsor: *EcoBeam Technologies - Mike Tremeer*

Acknowledgments: The buildings team would like to thank Mike Tremeer and everyone from Eco-beam for all of their help and guidance through the duration of our project. We would also like to thank Di Womersley from the Shaster Foundation, Buyiswa Tonono, and the rest of the community from Monwabisi Park for all of their great support and efforts during our time here. It was an ineffable experience to have had the privilege of working side by side with the builders there in helping with the construction of their township. Our sincerest gratitude goes out to all these people who gave us the opportunity to have been here.

Water and Sanitation Team: *Marcella Granfone, Christopher Lizewski and Daniel Olecki*

Sponsor: *City of Cape Town Water and Sanitation Department, Informal Settlement Division—Garnett Jefferies*

Acknowledgments: On behalf of the water team, we would like to thank the City of Cape Town Water and Sanitation Department, Informal Settlement Division for their constant support and guidance throughout the project. We also thank the community of Monwabisi Park for being so open and welcoming to us, as well as Di Womersley and Buyiswa Tonono of the Shaster Foundation.



Mapping Team and Sponsor



Buildings Team and Sponsor



Water Team



Energy Team

Energy Team: *Paul Kehrer, Bethany Kuhn, Jacob Lemay and Christopher Wells*
Sponsor: *City of Cape Town Environmental Resources Management, Sustainable Livelihoods and Greening Programmes - Jacques duToit*

Acknowledgments: Thanks to the City of Cape Town Environmental Resource Management Department for their valuable assistance and guidance throughout the course of this project. We would also like to thank the residents of Monwabisi Park and the Indlovu Project Community Centre for welcoming us into the community. We are especially grateful to our advisors, Scott Jiusto and Robert Hersh.



Economy Team

Economy Team: *Jason Coddington, Mark Dignum, Michael Fitzpatrick and Kelly Pastor*
Sponsor: *Shaster Foundation - Dianne Womersley*

Acknowledgments: The economy team would like to thank our advisors, Scott Jiusto and Bob Hersh, for **all their support and guidance throughout the course of this project.** We'd also like to extend our thanks to Mike Tremeer and Dianne Womersley as they greatly assisted the development of our project with **helpful insights and by believing in our ideas.** Finally, we'd like to thank the **Monwabisi Park community** for welcoming us and embracing our ideas.



Communications Team and Sponsor

Communications Team: *Marco Angulo, Amanda Jenkins and Matthew Perrone*
Sponsor: *Shaster Foundation - Dianne Womersley*

Acknowledgments: The ability for twenty-two foreign students to work hand-in-hand within the community of Monwabisi Park could not have been done without the help and support of many parties. We would like to thank the project advisors, Scott Jiusto and Robert Hersh, as well as Basil Tommy and Alastair Graham of the VPUU in organizing and working with the project site as a whole, encouraging and guiding us to our goals. Our work could never have commenced without the constant support and encouragement of the Shaster Foundation, as Diane Womersley and Buyiswa Tonono made our interaction within the community not only possible, but a truly enriching experience. Our thanks go to all those who we have met in Monwabisi; inspiring us, helping us, and making this project an unforgettable experience. *Enkosi.*

**Special thanks to the GE Foundation
for generously supporting the work of the WPI Cape Town Project Centre.**

The Integrated Plan for the Redevelopment of Monwabisi Park



CHAPTER ONE CONTENTS:

- 7 INTRODUCTION
- 11 WORKING AND RESEARCHING WITH COMMUNITY
- 13 KEY FINDINGS OF THE SIX GROUPS
- 16 PLANTING THE SEEDS OF REDEVELOPMENT
- 22 A NEW VISION FOR WATER AND SANITATION PROVISION
- 28 DISTRICT PLANNING
- 38 PLANNING ACROSS ENDLOVINI
- 44 MAKING IT HAPPEN: AN INTEGRATED PLAN FOR ECONOMIC DEVELOPMENT

AUTHORS

2008 WPI CAPE TOWN PROJECT CENTRE STUDENTS

INTRODUCTION

Since the end of the apartheid era in South Africa, freedom of movement and the search for economic opportunity has led to a large migration of rural people to the greater metropolitan areas of the nation. The large number of previously oppressed people moving into places such as Cape Town has led to an oversaturated job market and the creation of densely populated townships and “informal settlements,” communities of shack homes and minimal infrastructure and service provision. Townships like Khayelitsha, on the outskirts of Cape Town, are home to hundreds of thousands of people, including many living in temporary dwellings while attempting to gain a foothold in the local economy. Their situations have proved to be more permanent than temporary as the economy's growth has not, as of yet, been sufficient to accommodate their numbers and needs. The living conditions that now persist in the informal settlements have become detrimental to the well-being of the communities that live there. As they continue to transition towards permanence, the informal settlements must be improved to promote the healthy and productive livelihoods of their residents.

Community redevelopment in informal settlements has

presented a formidable and multifaceted challenge. Governmental approaches to settlement upgrading typically focus on providing better housing, while insufficiently addressing the societal aspects of the community or their economic development. Despite focusing almost exclusively on housing delivery, the rate at which this takes place is also inadequate: in Cape Town, 10,000 new government subsidized houses are built each year, while the backlog for this housing is between 250,000 and 400,000 units, and growing. It is clear that, although municipal efforts are being made towards improvements, the current practices are not the best solution.

An alternative approach is needed for community redevelopment in South Africa, one which addresses not only improvement of houses, but living conditions as a whole. Development must encompass jobs, community programs, health, education, safety, a healthy environment - all the elements of a productive society. The scope of these elements is embraced by the concept of an ecovillage, which promotes a self-reliant and sustainable community. Social institutions provide impetus for the evolution of a strong ecovillage, and it is in this manner that jobs and resources are created and utilized within the community.

The Indlovu Project is intended to create such a com-

munity. Launched by the Shaster Foundation 2005, the initiative's deep work within an informal settlement called Monwabisi Park helped the community there to produce several much needed services and facilities. They began with a crèche, which is a day care for children, many of whom have no daytime guardians. A community soup kitchen was quickly added, where people who have no income are able to get a good meal every day. The addition of a health clinic, youth center, and house for visiting guests all became part of the grand design. In addition to the local street committee that provides community leadership, additional players are now part of the Indlovu Project:

- **The Shaster Foundation**, a non-profit humanitarian organization with the goal of bettering the life through sustainability and conservation. Headed by Di Womersley, the Shaster Foundation has a strong presence within the Monwabisi Park community; they started and run the Indlovu Project, and community center consisting of a crèche, soup kitchen, youth center, clinic, and guest house.
- **VPUU (Violence Prevention through Urban Upgrading)**, a partner-

ship of the City of Cape Town and the German Development Bank to promote improvement through funding public safety programs.

- **The City of Cape Town:** Departments of Water & Sanitation and Department of Environmental Resources Management.
- **Ecobeam**, a construction company which specializes in alternative, more sustainable building materials and processes.

At the behest of the WPI Cape Town Project Centre, the members of these various groups of people have been able to collaborate their efforts towards the improvement of Monwabisi Park.

Significant progress has been made in the redevelopment approach embodied by the Indlovu Project. More attention is needed, though, as the project's scope is growing and higher levels of community services must be accommodated and nurtured. The housing challenge is both complicated and expensive, and advancing upgrading to the next level will not be easy. A fire on December 1st destroyed several homes and all of the existing buildings of the Indlovu Project. The setback to the community was severe, and also forced a major adjustment to WPI's 2008 work in its final two weeks in Cape Town,

bringing a focus on redevelopment planning that now also includes rebuilding the Indlovu Centre facilities, along with housing and proper water and sanitation facilities.

This document is the product of four months of research and analysis of the current situation in Monwabisi Park. This research was conducted by six teams of WPI students focused in the areas of Communications, Mapping, Buildings, Water, Energy, and Economy. This chapter represents the integration of these efforts into a set of recommendations for a cohesive framework for the redevelopment of Monwabisi Park. It seeks to improve upon standard upgrading practices and explore alternatives that are practical from both an expert stance and a community stance. This integrated plan encourages all parties involved to consider novel approaches to building and community development, grounded through a deep engagement with Monwabisi Park residents. The report is to serve as an in-depth case study for political leaders and agency sponsors to use in considering action in Monwabisi Park, and more generally in supporting informal settlements in Cape Town. The document will also serve as a resource for future WPI students who return here each year to further investigate and refine these plans, and help to face this challenge.

The Indlovu Project: *The Indlovu Project is a collaboration of the Monwabisi Park community and the Shaster Foundation, a South African public benefit organization. The goal of the project is to transform the area into an “ecovillage” embodying theories of community-based sustainable development and permaculture. In 2008, WPI students and faculty initiated a planning effort to help this vision become a reality.*

Monwabisi Park is located along the southern tip of Africa in south eastern Cape Town, South Africa, and is a neighborhood of Khayelitsha. Meaning “New Home,” Khayelitsha was established in 1984 during the apartheid era in order to accommodate the growing influx of black workers to Cape Town. When apartheid ended, there were no longer regulations on the movement of black people, and people poured into metro-

FACTS: MONWABISI PARK

- Founded in 1997
- 691 200 Square Meters
- Population 20 000
- Language: Xhosa, others
- Political subdivisions: Sections A, B, C, M
- Housing: 5 785 shacks (A 539, B 909, C 1 510, M 827)
- 33% of residential area is accessible by emergency vehicles
- 27% of shacks don't have heat*
- An average family of 5 uses over 120 Litres of water a day
- 45% of population is under 20 years old, 47% between the ages of 20 and 45, and 8% are over 45 years old*
- 23-45 % of population unemployed



politan areas from the Eastern Cape seeking new jobs. In many cases these workers only set up temporary houses on public spaces with the intention of either returning to the Eastern Cape or moving into more permanent housing once they had saved enough money. With so few jobs and such a large demand, these squatter camps quickly became both permanent and common place. Such was the case with Monwabisi Park.

In 1997, residents of neighboring Harare “invaded” Monwabisi Park, establishing shack homes and defying government efforts to remove

them from the area which, ironically, was both a nature reserve and a public landfill. The strength of community bonds and resolve borne of this and subsequent struggle lead residents to name the community “Endlovini,” meaning elephant and fierce strength in Xhosa.

The Indlovu Project began in 2005 when Di Womersley of the Shaster Foundation joined forces with Buyiswa Tonono, a local street committee leader and founder of a small crèche that became the first Indlovu Centre building. The crèche and subsequent Montessori Preschool cared for young chil-

dren, including AIDS victim orphans. A Youth Centre building opened in 2007 and became home also to a soup kitchen and health clinic downstairs and youth recreation and studying upstairs. The Makazi Guest House was built by community members using a unique “Ecobeam” frame and sandbag construction technique and offered a place for visitors and project sponsors to stay. A new backpackers lodge was under construction before the fire, and it was to house a hostel and community center, as well as a small restaurant for visitors.



Crèche / Montessori School



Youth Centre / Clinic / Soup Kitchen



Makazi Guest House



Backpackers Lodge under construction.

All of these buildings and programs are designed by the Shaster foundation, holding true to its vision of creating a tightly knit community working towards self-sufficiency and improved living conditions in a way that is not harmful to the environment.

All of the facilities are created for the direct benefit of the community, with Monwabisi Park residents working to build and operate them. This increases the sense of community, because there are common goals, and the services that are provided by the buildings help everyone, including members of the community who are unable to help themselves.

CULTURAL SERVICES

The Indlovu Centre was also a cultural centre, with ac-



Shacks in Monwabisi Park

tivities such as drumming sessions with Dizu, a founding member of the Shaster Foundation and a world renowned drummer, or classes that teach the traditional Xhosa bead work to community youth. At times there are stories told by the elders of the communities to the youth to pass on the lessons of their ancestors, and their history. In this way, the buildings housed the places where community traditions

could be passed on in a way that was easily accessible to the youth of the area, and the older members of the community who have knowledge to pass on.

EMPLOYMENT OPPORTUNITIES

The crèche, clinic, the soup kitchen and the guest house all employ members of the community, and the guest house all employ residents of Monwabisi Park. The guest house attracts people from the outside, backpackers looking for an authentic experience or volunteers who are working in Monwabisi Park. They pay to stay in the lodge, and eat there, which provides an influx of money to the Indlovu Project, and are encouraged to support local businesses by buying soda from



View from the Youth Centre before the fire

local spaza shops, or by hiring select people from the community as tour guides.

ENVIRONMENTAL AWARENESS

The Indlovu Project also tries to employ sustainable practices, being as environmentally friendly. They had installed composting toilets which convert human waste into rich compost for gardening, without needing the city to provide maintenance. The children in the crèche assist with growing plants, and many of them eat the vegetables that are grown there. Much of the water used, including that for the laundry system was collected rain water that was stored on top of the Makazi guest house in water tanks, or in back of the crèche.

To continue this vision, the

Indlovu Project is concerned with redeveloping housing, and furthering service provisions for residents beyond the scope of the Indlovu Centre. The project hopes to redevelop Monwabisi Park in a way that holds true to the ideals of the Shaster foundation, and best serves the





Volunteers painting the Student Centre

residents of the community.

The Indlovu project provides vital services to the community, and its members have the drive and the vision to create a better society and community for Monwabisi Park.

THE SHASTER FOUNDATION

The Indlovu Project: From a vision to a keystone of the community...

The evolution and construction of the Indlovu Centre, from ideas for a shack filled area to a community centre where people gather to work and enjoy themselves. The self sufficiency and community responsibility instill a sense of pride in residents because they have created these structures themselves.

Indlovu Project Work with WPI Students

In October 2008, we came to Monwabisi Park as a group of 22 students and 2 professors from Worcester Polytechnic University in Worcester, Massachusetts. We came with the intention of furthering the vision of the Indlovu Centre. We planned to take the model of the Indlovu Centre, and create a plan of redevelopment that could apply to all of Monwabisi Park. A group of 4 students from WPI had come to work at Monwabisi Park a year earlier,

learning about the community, and helping to build a rain water collection system and laundry centre. They were inspired, and the professors arranged to have a larger group return to Monwabisi park, and dedicate all of their efforts to an all encompassing plan for redevelopment.

Coming to Monwabisi Park, we were immediately welcomed by the community. We worked with key members of the community who had been trained



WPI students discussing housing ideas with co-researchers and community members during our second charrette.

by the VPUU (Violence Prevention through Urban Upgrading) to provide us with a safe environment to work in. Six community members were designated as co-researchers to work with us and provide a vital link between the students and the community. The co-researchers allowed us to survey residents and visit homes, guaranteeing our safety throughout the experience. The co-researchers provided a critical service, and we had the privilege of befriending them and forming lasting relationships.

Using the co-researchers as a link to the community, and various government and NGO sponsors who would be valuable resources, we set out to create a comprehensive plan

for redevelopment. To fully serve the community, we had to take into account all aspects of society. In order to give proper thought to all facets, we split our group into 6 different teams. The communications team would facilitate communication between the students,

the Indlovu centre and the community, as well as research and plan for communication within the community. The mapping team focused on researching infrastructure, roads, and space availability within Monwabisi. Additional teams would research current and future buildings, energy services for the residents, and issues of water and sanitation. Another group would research the economy of Monwabisi Park.

Divided into different research teams, and equipped with the resources of our sponsors and the community, we set out to document the existing conditions in Monwabisi Park. Gathering information from key informant interviews, group discussions, and survey data collected by the co-researchers, we managed to get a picture of the existing conditions of Monwabisi Park.



Working And Researching With Community

The ability to research in the community is the framework for all teams ability to gather data from the community. By starting with the VPUU training pool, preparation for working with our research group in English was started, as well as developing a mindset around increasing the safety of the community, focusing on the taking a stand to assist the community. for Increasing the density of information communicated from one party to another was achieved progressively, as well as the reach of our project work into the community, as seen in the table below.

VPUU SECURITY TRAINING

What: VPUU training program for 50 English-speaking residents of Monwabisi Park, teaching them the skills of being part of the neighborhood watch.

Why: The preliminary training made possible the co-research program, as well as to plant the mindset of community involvement, in specific the nature of the community watch,

CO-RESEARCHER PROGRAM

What: Program based on the Security Training Program, by having six of the fifty trained to act as translators, guides, and chief consultants.

Why: The WPI teams planned to have successful interaction with the community, in order to take into account their needs and wants into their designs, with the co-researchers enabling a bridge to any barriers present.

INTERVIEWS

What: Personal interviews with residents were performed by the Communications Team, alongside the co-researchers, who provided a sense of who to speak to and translation when needed.

Why: The ability of broadcasting to the world the voice of the community, which also showed the value of their individual voice and insights for the redevelopment process.

SURVEYS

What: Surveys were performed solely by the co-researchers in order to provide with basic demographic data over a large scale area, namely Monwabisi Park.

Why: The overall demographics data of the informal settlement is useful for future redevelopment entities involved by providing with a base to plan for and work upon, as well as can be transformed into projected statistics.

CHARRETTES

What: Discussion meetings between WPI teams and community members in order to agree upon developed designs for the current redevelopment plan.

Why: The discussions provided with unforeseen and important aspects of the community that had to be incorporated into the original designs so as to ensure a satisfactory redevelopment plans.

ENDLOVINITV

What: The evolution of using video recording in the interviewing process, Endlovini TV is a group forum that takes the form of a TV talk show, progressing into an entirely self-sufficient process, using interest found through surveys for new guests.

Why: The TV show aspect is the culmination of both our skill exchange and the opportunity to spread **the community's voice.**



These pictures represent the various phases of research we progressed through, showing the need for a well organized, well established co-researcher program.

Rising From The Ashes

On December 1, 2008, tragedy struck the Indlovu Project and Monwabisi Park in the form of a fire that consumed many house holds and all of the existing buildings of the project. Despite the devastation, the community is recovering, and working with WPI to rebuild and plan for further future redevelopment.

During our time working with the Monwabisi Park community, the community was struck with two devastating fires within the informal settlement.



NOVEMBER 1 FIRE

The first burn involved about 10 shacks within C section

of the settlement. This unfortunate occurrence provided the WPI teams with an opportunity to try to allocate that space for use by the same residents, with a new means of housing. Yet, the city acted in a fast manner, providing with basic materials in order for those affected to start the rebuilding of their shacks. The idea of having communal housing was then discussed with several community members in the forms of charrettes and several of the affected residents showed a sense of interest for these ideas, although most of them were already diligently working to reconstruct their homes, as they were important for them.



DECEMBER 1 FIRE

Just a month after the first fire, a second larger fire swept through an even larger area of Monwabisi Park. This fire destroyed about 19 shacks, as well as all of the structures in the Indlovu Project. Eight of these affected shacks were able to salvage several of their belongings, while the other eleven lost all of

their possessions to the fire.

This new disaster affected a bigger part of the residents in the park, not only because of the increased number of shacks affected, but also because of the destruction of the facilities of the Indlovu Center that provided many services to all the residents of the park. The city, in this instance, also provided with basic materials in a timely manner, which provided the affected people with essentials to start their reconstruction. Yet, these few materials are not enough to complete their new homes, which is the reason why the people must scavenge through old materials in the hopes of finding useful parts that can be used in their new constructions.

set up, and there are other buildings planned for the near future to start providing the essential community services that were lost in the fire. WPI teams have designed future plans for a new Indlovu Center, plans that will also take into account the need for the prevention and rapid response to the present disasters involving fires.

WPI hopes to help the community recover from the loss of



MOVING FORWARD WITH REDEVELOPMENT

But, a great amount of support has been present throughout the disasters, including the help that WPI teams were willing to provide as well as the organized donations by the Shaster Foundation for the new Indlovu Center that will be put in place once again for the use of the residents of the park.

The Shaster foundation and the residents involved in the Indlovu Centre have not lost their drive better the lives of Monwabisi Park residents. Currently, a Wendy House has already been

the Indlovu Centre by planning for a rebuilding of the Centre as well as a plan for redeveloping the surrounding area. To make accurate recommendations that will best serve the community, we needed an understanding of the existing conditions of Monwabisi Park. The following pages show the key findings that each of our groups have found to be key concerns that need to be addressed when planning for redevelopment.



A progression of the fires suffered around the Indlovu Centre as seen in the area directly behind the to-be Backpackers Lodge. The leftmost picture is on our day of arrival, before any fires. Centre panel is three days after the first fire: the blue building, as well as the structure behind and to the left of it, were rebuilt in the three-day span. The rightmost photo shows the area after the Indlovu Centre fire, use the both the white house with blue window frame and electrical post for orientation.

Key Findings of the Six Groups



many of the problems that people consistently identified were discussed amongst fellow neighbors, but never to a party that had authority over the situation, usually a branch of the city's civil service. The community members, being vocal about problems and situations they held as important, had no outlet for organized discussion. In terms of research, the need for capacity within the park was readily identified when we arrived in Khayelitsha. The process of starting work within a small group of co-researchers, acting as liaisons, key informants and translators, and working outwards into larger groups and, ultimately, large parts of the community as a whole, proved to be a successful way to conduct research through various communication means. Community involvement, being a keystone in this redevelopment plan, is missing in the current redevelopment process of informal settlements: clearing areas of shacks are replacing them with pre-fabricated housing solutions breaks the sense of community, leading to vacancies and abandonment, as well as an increase in crime. Involving the community is a large-scale en-

deavor, but not only is it beneficial to garnering support, involvement and insight, it is a crucial to conveying a sense of ownership of the plan to the community as a whole, as well as being a truly rewarding experience.

MAPPING



The current roads system in Monwabisi is inadequate for emergency vehicle use in the majority of the Park. Fires can devastate relatively large areas in informal settlements and due to a lack of road service the fire trucks are unable to respond for hours if at all. The level of safety for pedestrians is low especially those who live along the back of the Park. The majority of travel routes are unlit at night and are often host to criminal activity. Dark areas near bushes and around structures are spaces where criminals can hide and surprise their victims. Traffic accidents along Mew way are also common and pedestrians are often injured in the process.

BUILDINGS

The housing conditions within Monwabisi Park raise concern for the quality of living. The housing is comprised of shacks which are made from corrugated iron and wood. These materials do not provide adequate shelter from the elements; often the roofs will leak

and there is no insulation for the building. When the shacks were being constructed, they were not built in accordance with any design or plan. As of now, there is not much open space for gardening or play areas for children, and expansion is almost impossible. In building the shacks as they have, the community in Monwabisi Park has exhausted most of the available building space.



COMMUNICATIONS

The process of interacting with the community of Monwabisi Park, largely through the co-research program, identified significant lapses in communication in the ecologically-minded redevelopment. Within the community, we found that



further insulation impossible. Heating is done using unsafe paraffin stoves, or with wood burning Imbawulas, which are both fire hazards with unhealthy emissions. The community is also not well informed of alternatives to paraffin and electricity. Residents of Monwabisi park must spend a significant portion of their monthly income on energy services, preventing them from investing in more efficient technologies.

WATER & SANITATION

The water and sanitation services in Monwabisi park are inadequate and unsafe. Facilities are located far from shacks which results in dangerous conditions. The taps and toilets are in poor working conditions due to misuse and vandalism. Pit latrines are built by residents as alternate options, but cause serious health issues. The cost of maintenance is excessive and inefficient for the city department, contributing to the vast state of disrepair. Poor conditions of taps and toilets lead to public and environmental health concerns. Contaminated taps and toilets are vectors for the spread of waterborne diseases. In order to address the current conditions, an integrated plan has been designed, that incorporates elements of sustainability.

ENERGY

Electricity is the primary energy source for residents of Monwabisi, and its supply is inadequate. Whole sections of the park have no direct access to the grid, and must use unreliable, unsafe, informal connections. Homes are poorly insulated, and leaking roofs make



Monwabisi Park is a cash poor community in need of job creation and skills training. Current unemployment rates exceed fifty percent. Those that



are employed have difficulty adequately meeting the demands of work transportation, food, electricity, and other expenses with their often minimal incomes. There exists however a desire within the community to learn new skills and seek employment opportunities. This integrated redevelopment plan will play an important role in catalyzing economic opportunity for the community.

CREATING A PLAN

These key findings are vital to creating a redevelopment plan. Using these key concerns, we have created plans that will take into account the largest problems facing the community. Moving forward, we will analyze redevelopment on different scales, making sure to analyze all potential challenges, and pose questions for further research.

Our time spent working with the Monwabisi Park community allowed us to gain insight into the issues faced by Monwabisi Park residents, as well as form relationships with community members working with the Indlovu Project.



Integrated Plan: An Overview

Following the fires, our team devised three levels of analysis which enable a discussion of our redevelopment ideas for Monwabisi Park. The areas affected by the fires represent the spaces used for two of the three levels of the vision. The first level, referred to as the Redevelopment Seed (seen on the upper right), is a plan for rebuilding the Indlovu Centre and outlining elements needed for community centres in the three other sections of the Park. The second level, which we refer to as the District (seen on the middle right), is a conceptual realization of principles and strategies identified by our group as essential to the redevelopment of Monwabisi Park. Also, this is not meant to be understood as a literal plan for development, but instead it is an example of the many concepts involved in our vision. Applying these principles across the entirety of Monwabisi Park, we propose the third level of our vision, referred to as Endlovini (seen in the bottom figure). This level will discuss larger community facilities which will service all of Monwabisi Park. The fourth piece of this vision will discuss the realization of these levels through organization of community involvement paired with outside funding.

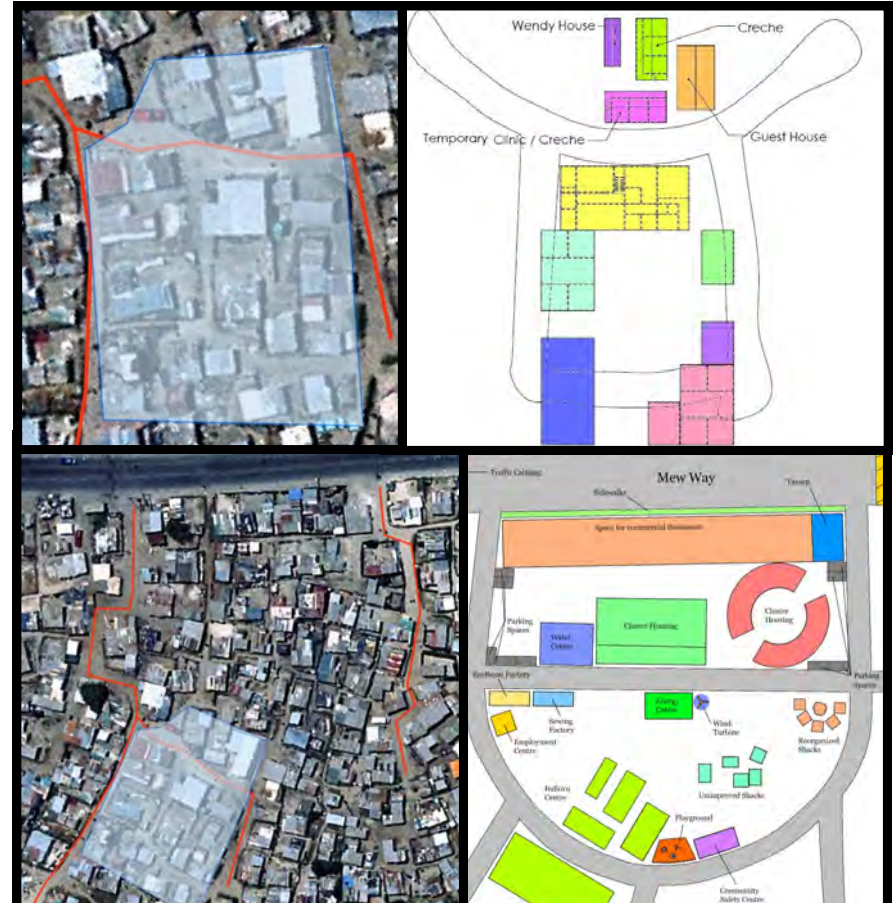

Introduction:

Planting the Seeds of Redevelopment

It would be an act of inhumanity to overlook the tragic element of the fires that destroyed the Indlovu Center. Many people lost their homes, and the community lost some of its most needed facilities. However, it would be equally reprehensible to not learn the lessons from this disaster. The spirit of the Indlovu Project never faltered. The very day after the fire, a makeshift soup kitchen was set up. Building materials were secured for a new crèche. Instead of lamenting their loss of possessions, people rejoiced that there was no loss of life.

There is now an opportunity to rebuild the Indlovu Center. In doing so, it is paramount that the ideals of the Indlovu Project are not only maintained as they were before the fire, but also that they are broadened and reinforced. All the needs of a developing people must be addressed, most importantly but certainly not limited to health, safety, education, community, and culture. The Indlovu Center addressed these needs by having a crèche, a soup kitchen, a clinic, a youth center, a community hall, and a school. These critical elements must be retained in the design for the new building.

The loss of homes was mitigated with astounding speed. Not a day had passed since the fire, and a half dozen shacks had already reappeared in the still warm ashes that were left of their predecessors. The residents of Monwabisi Park have little or no alternative to the shacks in which they live. In such a disaster they are driven by the clear and present need to have a roof over their heads and the heads of their loved ones. Sadly, though these structures do provide a level of shelter, they are not impervious to the elements. Often they are subject to flooding in the rainy seasons, and almost always leak water through the roof. Insulation is sparse at best, and the temperature inside a shack is rarely very different than the temperature outside the shack. The tenets of the Indlovu Project must be realized not only in the structures that provide community services, but also the structures that house the members of the community. A vision has endured throughout the people in Monwabisi Park for the eventual improvement of the quality of their lives through the improvement of the quality of their homes.

The concepts of community development and housing development are both critical to the overall redevelopment of an informal area. The current methods by which civic improvements are made tend to unanimously fail at satisfying both of these criteria. Most typically, a redevelopment scheme occurs in the following steps:

- Choose an area, usually supporting 100 or more homes
- Vacate the area of its inhabitants, relocate them
- Clear the area off all structures present, install utility infrastructure
- Install rows of identical houses
- Move the original population back into the area

The primary problems that this presents are: where to relocate the people during redevelopment, the total destruction of any existing infrastructure the people may have found

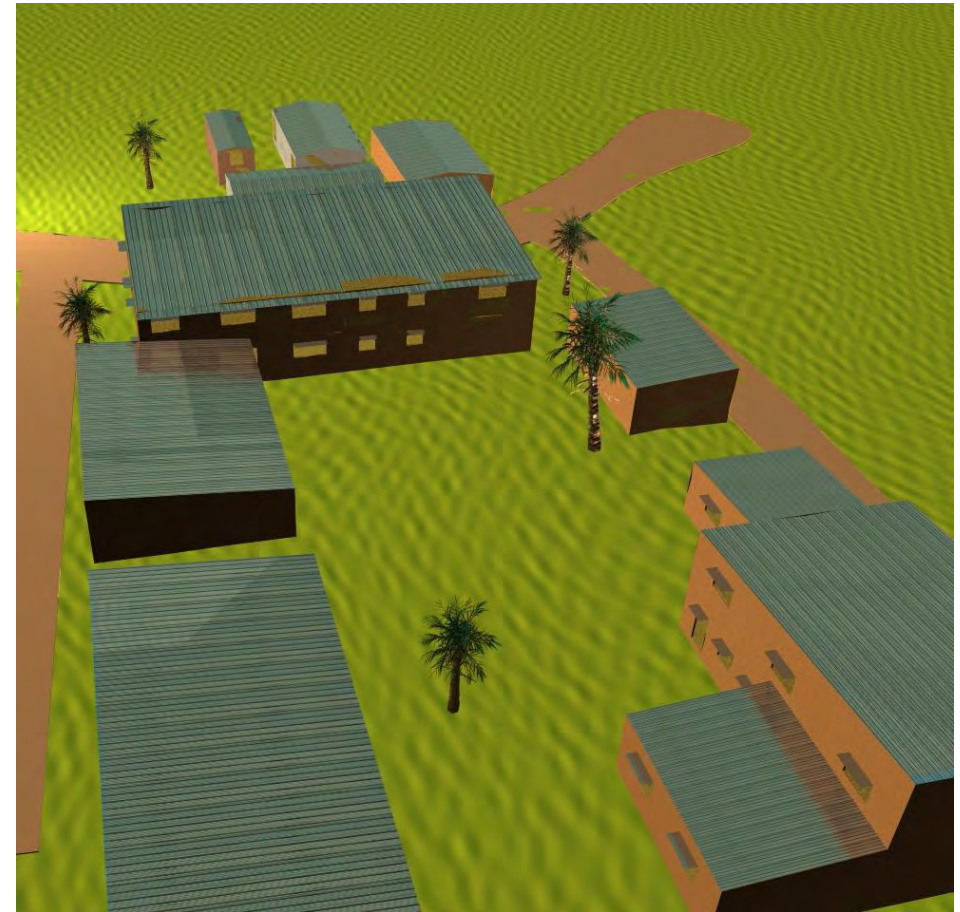

View of Indlovu Project from behind

Introduction:

Planting the Seeds of Redevelopment

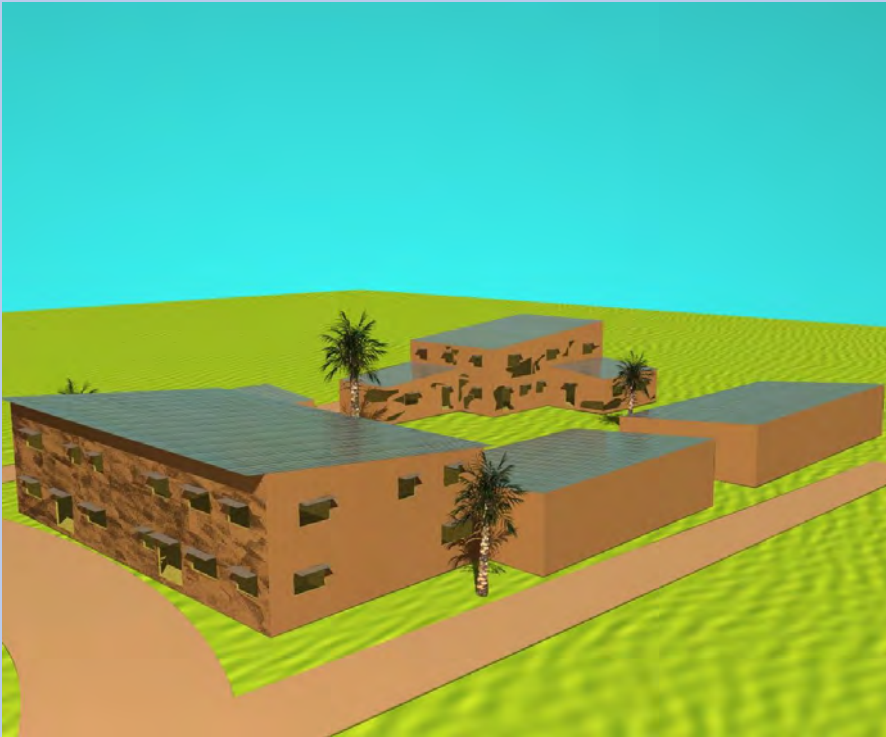

View of Indlovu Project from front left corner

pleasant and useful to their way of life, a monotonous and repetitive neighborhood, and total chaos re-settling the newly formed area due to it having no relevance to what existed there before. Further analysis of the method will suggest that the main cause of these problems is the size of the area involved. Replacing whole villages of people at once creates too much change for the body of people associated with it, as the numbers viewed by present bureaucracy are simply how many houses to build. There is a large population that is typically scattered to various corners of the metro area until their homes are replaced. A more elegant solution would be replacing a much smaller amount of houses at a time, relying on a "relocation facility" to house the people in-process. This facility would be like a hostel, capable of supporting up to six families while renovations take place.

A distinct advantage of modern redevelopment practice is that it does allow for distribution of utilities to the area in focus. The people in Monwabisi Park, while receptive to the idea of having individual toilets and water faucets, are presently accustomed to traveling large distances to water taps and toilets that are shared by a huge amount of people with little or no maintenance. These two extremes can be compromised by the introduction of a centralized facility that would be staffed to ensure safe sanitation practices and distribution of clean, healthy water.

A "redevelopment seed," then, must have the following basic constituents:

- A community facility (Indlovu Center)
- A relocation facility
- A water facility

It must also invest less, if any, of the labor and decision making process in the government's and instead promote these activities in the communities undergoing the redevelopment process. The social structure of Monwabisi Park has proved that this can occur; the community has an impressive level of autonomy that is actively and democratically maintained by several committees for issues ranging from street safety to the hierarchy of future redevelopment. This structure also highlights the importance of a symbiotic and simultaneous approach to the upgrade process: the community center serves as the locus for these groups of people to meet and discuss policy. The community center will also be the site of a facility to generate sand bags and other textiles, which need only be a room that can store fabrics and run a few sewing machines. The products made here will be used to build more houses and generate incomes, which will bolster the effort to improve the overall quality of the area.

The method recommended by the "redevelopment seed" approach is flexible, powerful, and easily repeatable. It allows for a relatively small external investment to quickly allow a community to take its redevelopment into its own hands by immediately nurturing not only the needs for new housing, but for social identity and productivity.

Indlovu Centre:

The first floor will house offices, the community clinic and a hall for public community use.

CLINIC: **Description:** The clinic is opened to the entire Monwabisi community as a day hospital. A doctor is available from 7am to 4pm for any medical needs. Medicine is provided to the sick as well as any other medical supplies.



Size: 12m x 12m
Occupancy: 50
Staffing: Doctors and nurses
Access needs: Access from main road
Amenities: Toilets in clinic
Equipment/supplies: Pharmacy supplies, Medical supplies, chairs, tables, exam room supplies
Storage: Storage for medical supplies
Security: Locks on doors at night
Financial flow: Cost: supplies, staff

COMMUNITY HALL: **Description:** The hall will have flexible space that the community can use for gatherings or other activities such as street committee meetings. It can be transformed for children's activities or late night classes for people seeking to learn a trade.
Size: 9m x 12m, **Occupancy:** 50, **Access needs:** Access from main road, **Amenities:** Toilets nearby, **Equipment/supplies:** Chairs, tables

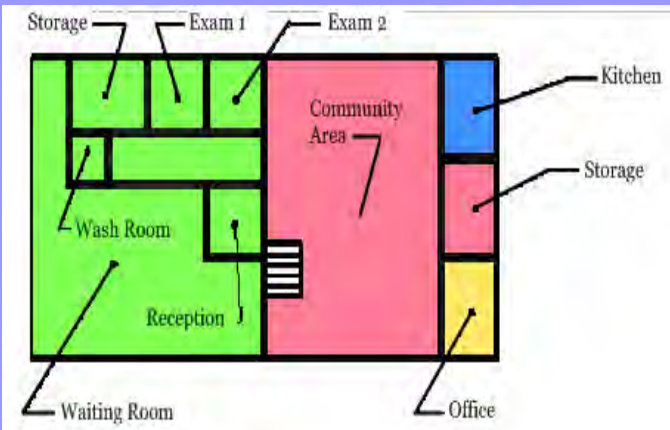

KITCHEN: **Description:** Attached to backpackers lodge or restaurant to provide food to guests and provide training for the community members



Size— 3m x 4m
Hours — 11am-1pm
Staffing—Cooks
Amenities—Toilets nearby
Equipment/supplies—Equipment needed for cooking, seating area, food supplies
Storage—Separate room/ refrigerator to store food and cookware
Security—Locks on entrance to kitchen

OFFICES: **Description:** The office is used for managerial purposes, housing documents and providing information within the Indlovu Project area. The office can be utilized by the Shaster Foundation.
Size: 3m x 4m, **Occupancy:** 5, **Access needs:** Access from main road, **Amenities:** Toilets nearby, **Equipment/supplies:** Office supplies



Indlovu Centre:

The second floor will house the youth centre, a learning centre and a workroom .

YOUTH CENTRE

Description—The Youth Center is open for the children of Monwabisi Park after school hours. It is an area for them to gather, do homework, and have fun.



Size— 7m x 10m

Occupancy— 40

Staffing— Counselor

Access needs— Access from main road

Amenities— Toilet nearby

Equipment/supplies— Pool Tables, Games, Television, Movies, Art Supplies

LEARNING CENTRE

Description: To provide a space for community learning on all levels - childhood, adult, skills and trades. Residents can come late at night after work to learn a new trade or brush up on previous skills.

Size: 5m x 12m, **Occupancy:** 30, **Staffing:** Teachers,

Access needs: Access from main road, **Amenities:** toilets nearby, **Equipment/supplies:** Desks, blackboards, chalk + erasers, academic supplies

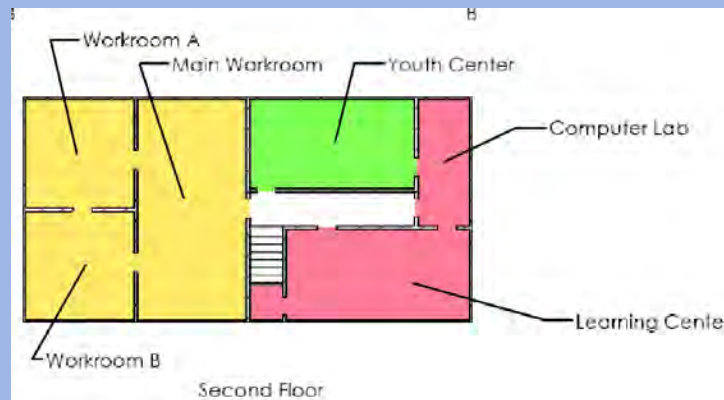

WORKROOM

Description— To provide a space for production of textiles as well as an area for artisans to work and train others in the trade of carpentry. Sewing and doll making are two examples of goods that can be produced in the workshop.

Size: 6m x 6m, **Occupancy:** 10, **Staffing:** Teachers/instructors, **Amenities:** Toilets nearby, **Equipment/supplies:** Multiple sets of woodworking tools as well as stationary power tools

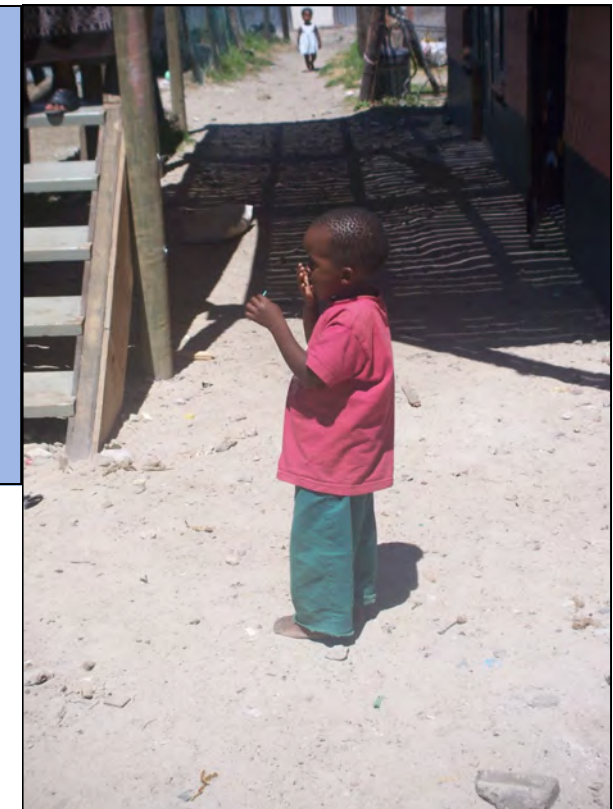

Other community buildings:

Across the street from the Indlovu Centre will be a crèche, guest house and a Wendy house for various uses.

CRECHE **Description**—The crèche serves as a place for children as young as 6 months to be cared for during the day. Not only are they cared for during the day but educational services are also offered. This building also offers preschool services.

Size: 6m x 9m, 80m²



Occupancy: 40

Hours : 8am-3pm

Staffing: Teachers

Equipment/ supplies: Educational supplies, desks, blankets, tables, chairs

Storage: Areas to keep toys and educational tools

Security: Locks on doors at night

GUEST HOUSE **Description**—Provide lodging for backpackers and provide income for the Shaster Foundation as well as the Indlovu Project. Guests can spend a night in the park and enjoy food prepared in the kitchen and experience a night in Monwabisi Park.

Size: 6m x 9m, **Occupancy:** 20, **Hours:** 24 hours, **Equipment/supplies:** Bedding, bathroom and shower equipment, **Storage:** dressers and bins for overnight guests

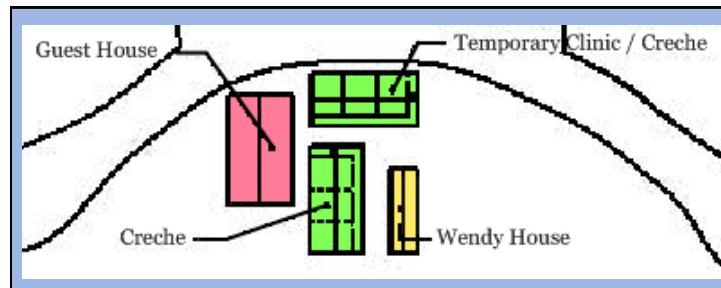

WENDY HOUSE **Description**— The Wendy house can be utilized for storage or other various activities. It can be used for a small night classroom for adults or a small workshop for handiwork such as sewing or doll making.

Size: 3m x 9m, **Occupancy:** 20, **Hours:** 24 hours, **Equipment/supplies:** Storage areas for supplies



Housing Structure

The accommodation of people into better homes is one of the core concepts of upgrading informal settlements. While it is very important that a redevelopment strategy does not attempt to fit the entire population of Monwabisi Park into a single mold, it is possible to create repeatable units for domestic organization in accord with community preferences.

This project's proposed unit of housing will satisfy the needs of the citizens of Monwabisi Park while addressing such concepts as densification, adequacy, and cost. It offers a level of diversity within the structure, which breaks up the monotony of typical project housing. The 10x15 meter structure's footprint offers a larger dwelling for each of six families in the same area that is currently occupied by four families. The internal subdivisions each offer fifty square meters of living space, for a 40% increase over average current living space. The Ecobeam materials and methods used in the construction process would result in less investment per capita than RDP housing, far greater longevity than existing shacks, and superior thermal qualities to both.

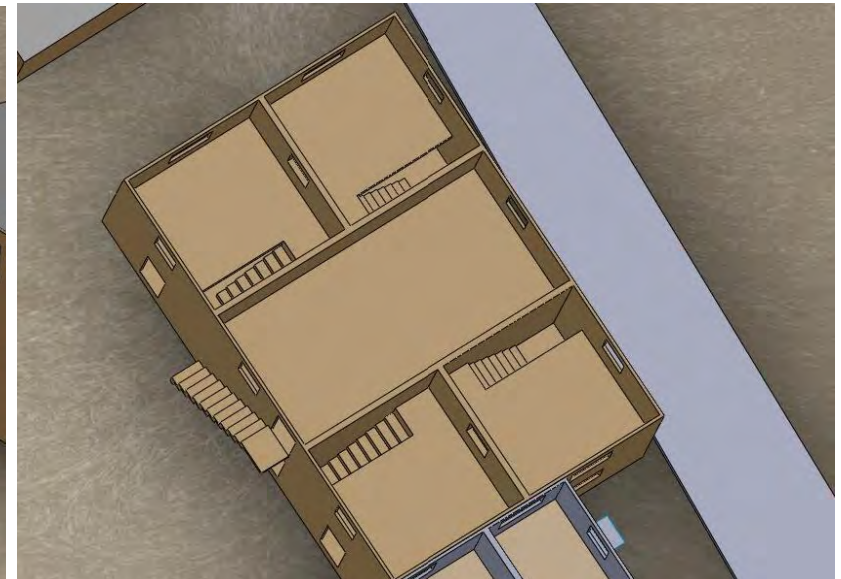
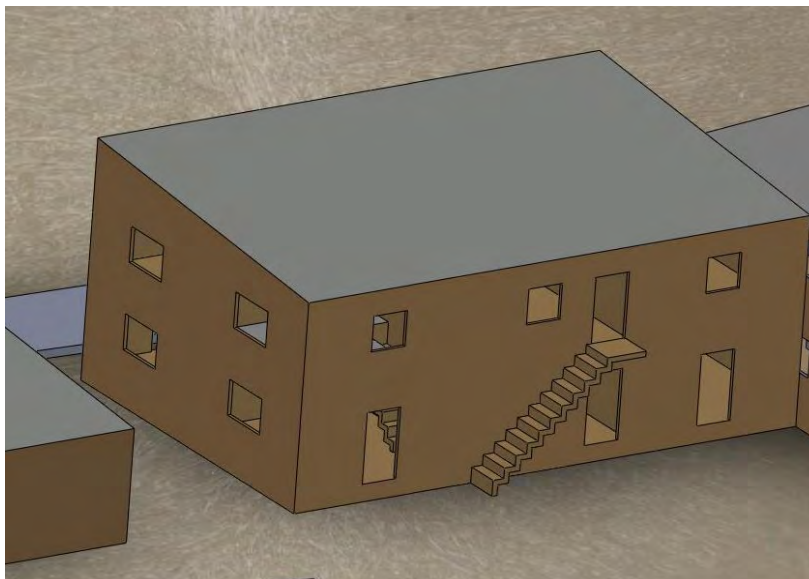
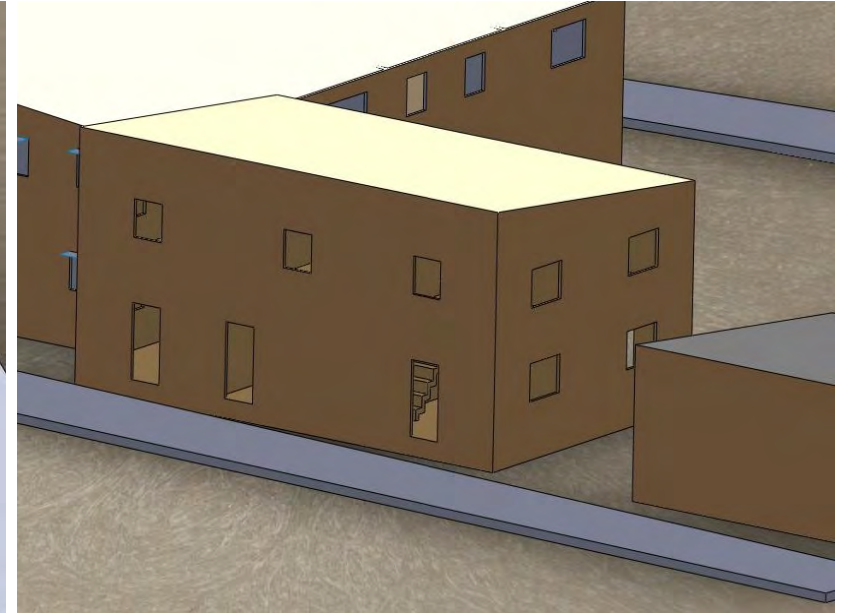
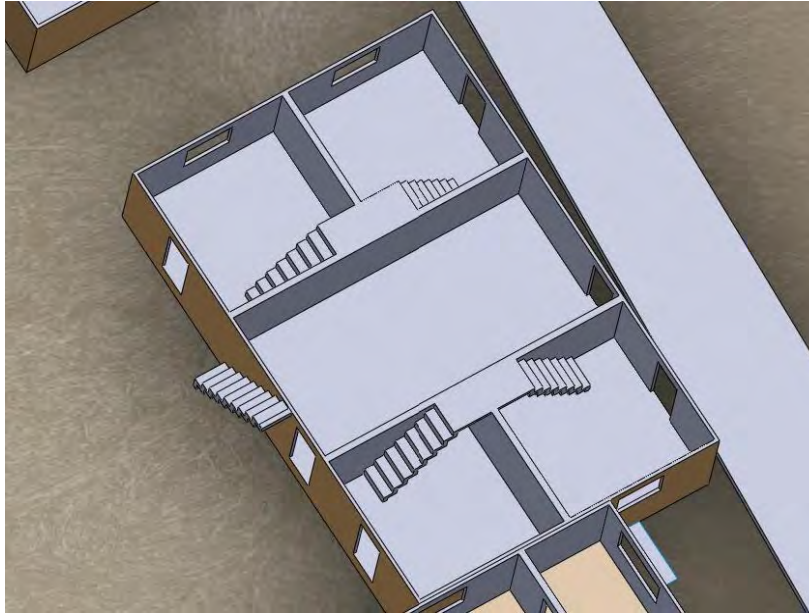

A New Vision for Water and Sanitation Provision

water and sanitation facilities in Monwabisi Park are inadequate and poorly maintained. New toilets are vandalized and become areas of high crime and rape. Stand pipes are broken and drains are blocked causing standing water to flood local areas. A new strategy must be implemented in redevelopment.

CONDITIONS ARE DIRE

The infrastructure of water and sanitation in Monwabisi Park is failing. Considering taps alone, 74% of them are malfunctioning. This leaves only one fully functional tap for every 246 residents in C section. There are accounts of people walking nearly two kilometers to reach a working tap, and due to disrepair and vandalism, thousands of kilolitres of water are wasted. Standing water gathers around the taps breeding diseases such as malaria, cholera, hookworm, and rota virus. Insects breed in the puddles, contracting the illness and spreading it to the community.

77% of toilets are either nonfunctioning or unmaintained.

An inexpensive light pole that could be installed nearby toilets and taps.



Within the first six months of installation, 30% of facilities fail. There are only enough provided toilets for 69 families to share a single unit under the assumption that they all work. Crime rates skyrocket at places where new toilet facilities are installed, promoting residents to use "black buckets" at night rather than walking to toilets. The location of implementation has been limited to the areas in which service vehicles can access the toilet pods. This leads to unsafe placement and in essence, crime is being installed with facilities.

DISEASE IS RAMPANT

The convenience and accessibility of hand washing stations is nonexistent. Health education is also taught, but not enforced. People use toilets and neglect washing their hands. Frequently, these same people will then use a tap and contaminate the faucet for anyone who uses it after. Bottles are filled for infants from the same taps thus contaminating them with the disease. Children are at a much higher risk for illness and are more apt to develop diarrhea from the taps, a serious illness that can easily lead to their deaths. The simple



Taps located near toilets can be easily contaminated and aid in the spread of disease



Clean and sanitary toilet systems promote good health and hygiene

fact that diarrhea is the number one killer of children under the age of two in informal settle-

FIVE KEY PRINCIPLES

From these core problems a list of principles was developed to aid in the future building of facilities. It would be ideal for a facility to be constructed with these concepts in mind. These principles are to

promote: water conservation to provide "green" services, hygienic benefits and services and positive byproducts to increase health and sanitation, safety to ensure that people are able to use the facility without potential harm, and replicability for the ease of implementation and sustainment of the complex no matter where it was located. All of these ideals can be incorporated in a master design that is both flexible and effective.



Centralized Water and Sanitation Facility

A facility has been designed that attempts to accommodate solutions to every problem discussed by the water team. The conceptualization of the complex is directed toward a shared communal and private audience to facilitate their daily activities relating to water.

OVERVIEW

The facility will be semi enclosed by an L-shaped structure that allows access from only one direction to the facility. This opening will be directed toward a public area where many people have a constant view of the area. This will help deter crime as well as pro-

mote a communal area to perform daily tasks in an enjoyable environment. A garden is located in the middle of the grounds to provide place for drainage from various parts of the complex. Benches are incorporated into the design to provide a comfortable area to wait for a particular service or

act as a communal gathering area. Taps are conveniently built at the entrance to the facility for residents of the community to gather their water for cooking, drinking, and all other daily needs. A building is placed at the corner of the complex to house an on site specialist who cares for the facility and

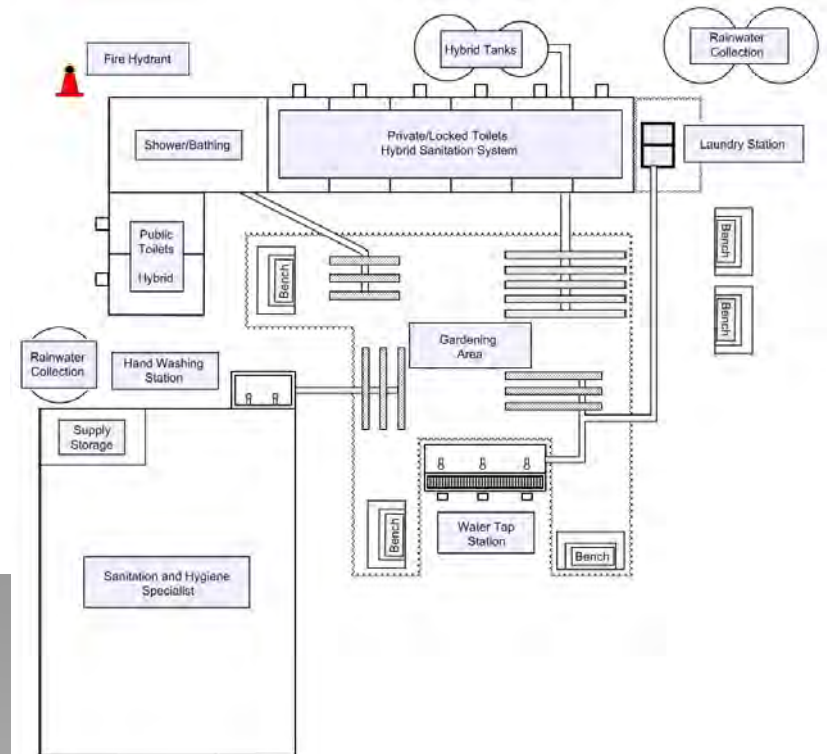
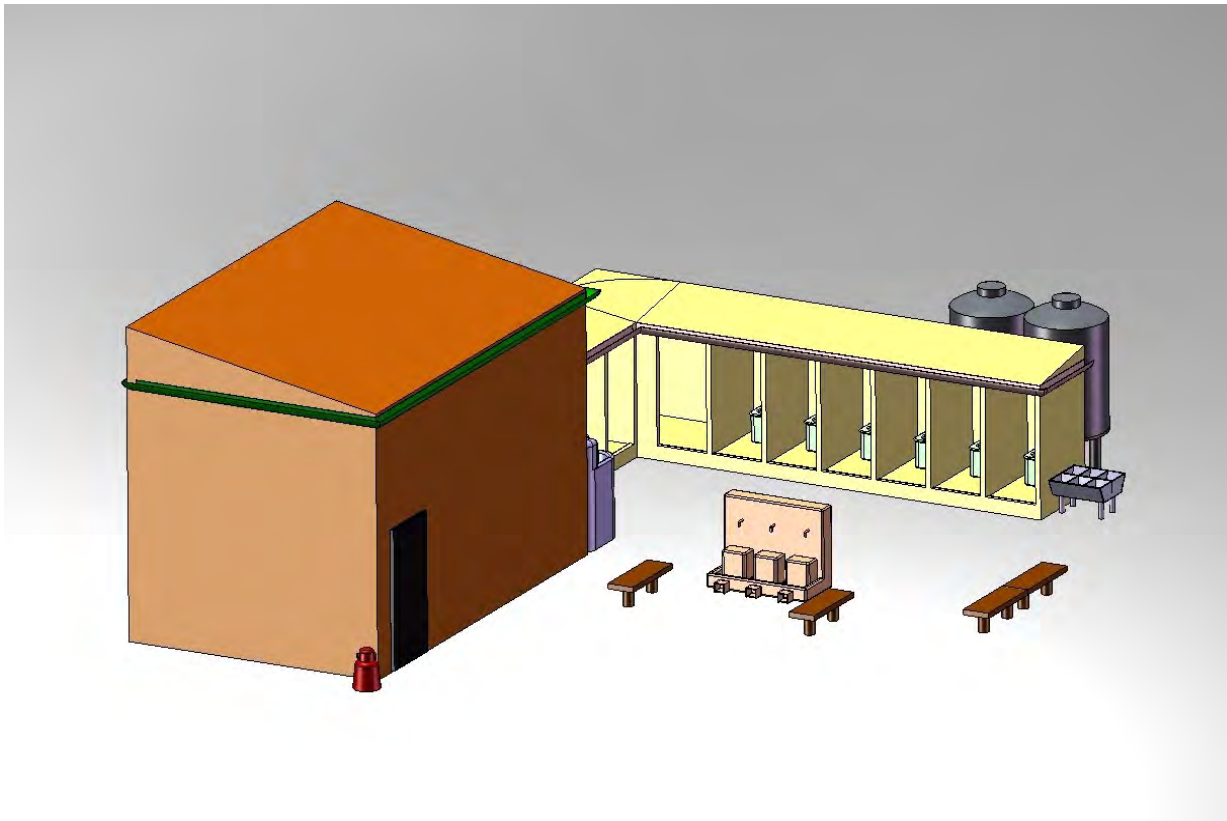

monitors the area. A sink for hand washing is built onto this house to promote healthy practices. Rainwater collection tanks are incorporated into the design to allow for the gathering of additional water from rain to aid the water supply for laundry and hand washing. Toilets and wash areas are installed in the L-shaped building with entrances facing the main courtyard. Finally, a fire hydrant is added for the safety of the community. Specific details of the facility will be discussed in the following sections as well as explanations to how the different aspect of the facility were designed.

PRIVATE AND COMMUNAL

One effective way to deter jealousy amongst community members is to create a facility that is accessible to everyone. A predetermined number of toilets are assigned to two houses each. People can choose who they share the toilets with out of a given set of houses. Public toilets are also present to accommodate passersby who may need to use the facility. The laundry facility and taps are also included in this area to influence a sense of communal sharing as well as a sense of ubuntu.

Water and Hygiene Official

The water and sanitation specialist will be created to manage the centralized water facility. The responsibilities include health and sanitation education, maintenance, and providing supplies.

Presently, the City of Cape Town Water and Sanitation Department has established facilities throughout Monwabisi Park; however, these systems are often misused or vandalized as a result of the lack of instruction and education. It is necessary that the community has someone to contact when the water facilities break down. The creation of a water and hygiene official will maintain the water facility being designed.

The official will be responsible for all aspects of the communal water facility. They will live onsite at the facility and will have a supply closet located within their house. By living at

the facility, the official can observe the activity at the taps, toilets, and sinks at all times. This person could inform users to wash their hands frequently since they would be located close by the sinks. More duties include: simple maintenance of the taps and toilets, such as fixing leaks or repairing blocked toilets. Preventative maintenance on municipally installed systems is equally as important. In this regard, it would not be necessary to involve the CCTWSD with small problems within Monwabisi Park. However, if the official encounters more serious problems with the systems, it will be

his or her job to act as a liaison and contact the city department to repair it. The added benefit to this is that the amount of money that this person is paid to maintain the facility will total less than the amount that the city must pay contractors to fix and overhaul facilities.

The other aspect of the official's job involves sanitation and hygiene. There is a need for health education within Monwabisi Park. The official will act as a specialist and will educate the community on proper sanitation, such as bathing daily and washing hands frequently. Disease transmission will be made clear and will be directly correlated to poor hygiene. Premixed medication for diarrhoea will be distributed by the specialist but more serious cases will be sent to the clinic. In order to prevent disease transmission, the water official will fill water containers for the community to prevent people from touching the taps. The containers will have sealed covers to isolate the water from possible contamination. Every house will have one container and the facility will have one container for every house. Therefore, residents can only get a newly filled

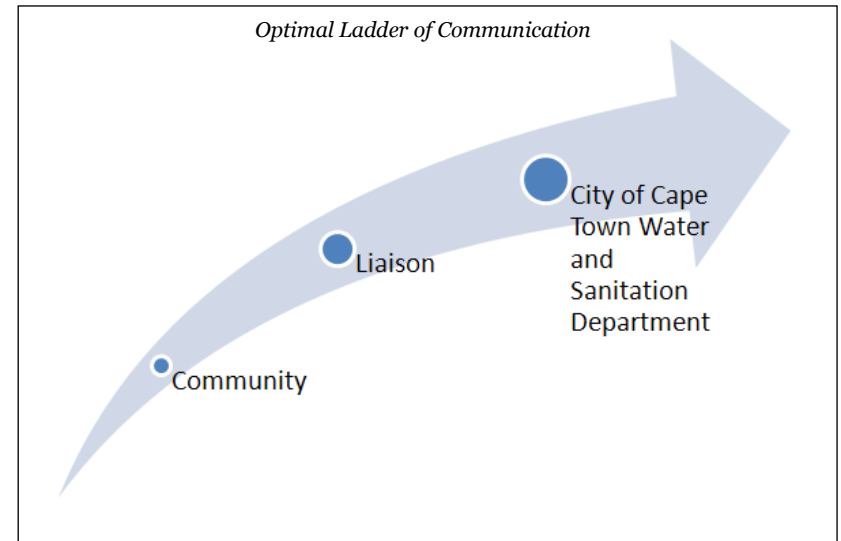

container when they bring their previous one back for decontamination.

The official's authority involves taking privileges away from those who do not follow rules or vandalize the facilities. The position of the water and hygiene official is vital to the survival and maintenance of the communal water facility.

The selection process for the liaison must be controlled by the local leaders and the Street Committee. The Street Committee and Buyiswa will receive a job description and application and distribute them to select individuals capable of **the specialist's responsibility**. After the Street Team has made a selection, interviews will be conducted and the specialist will be selected. The selected individual will need maintenance training by the CTWSD, which will depend on the sys-

tems implemented. The payment of the specialist will be determined by the Shaster foundation. The creation of such a job would provide employment and create a viable job market in the field of maintenance.

The training program for the specialist can be drawn from the Leaks Project. The city sponsored Leaks Project was a training program for community members in informal settlements. Unfortunately it was discontinued, but the concept can be applied to Monwabisi Park. The Leaks Booklet can be found in the appendix **^LEAKS**. It gives detailed instructions on how to repair taps and toilets, how to read meters, and other responsibilities of the water specialist. The leaks booklet is a valuable resource that can be left behind for community use.

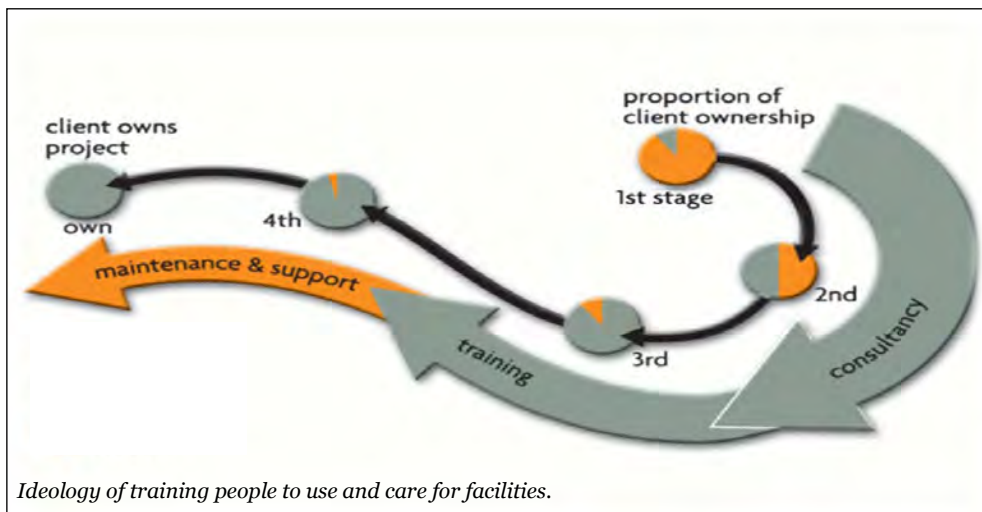

Ideology of training people to use and care for facilities.

Toilet Accommodations

Toilet designs have been chosen to promote cleanliness, water conservation, and ease of maintenance. A simple design and calculated placement add to the principles of safety and increasing hygiene.

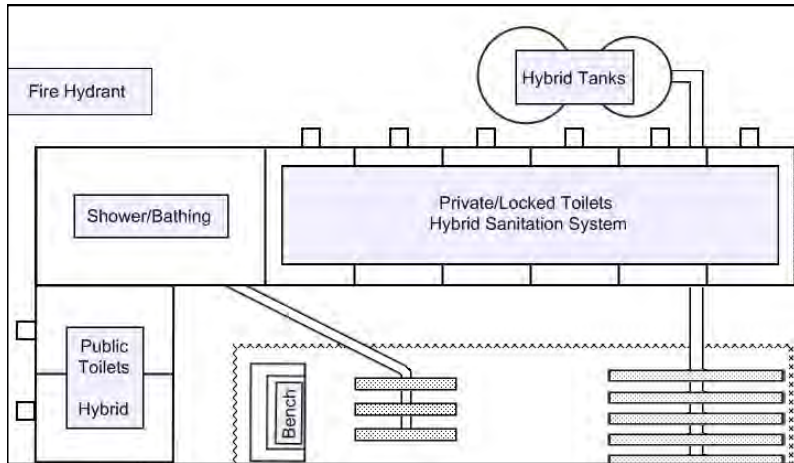

PLACEMENT

The toilets are placed at the rear of the facility where they are under total visibility of the entire complex. As aforementioned, this will help deter criminals from striking where community members would be witnesses.

SIDEWALK PATH CONTROL

A sidewalk is paved around the garden past a sink and also past the sanitation specialist. This will enable the official to keep track of who enters and exits the facility. Also, this will help promote the use of the hand washing station located right alongside the sidewalk. Another added benefit is the

fact that the public toilets can be kept separate from the private toilets that are assigned to the local residents. A low gate could be installed that is approximately waist high that remains unlocked to turn away people that are not residents.

TOILET TYPES:

HYBRID TOILET SYSTEM

The hybrid toilet system is the first suggestion as a toilet system because of its extremely low required maintenance. It is a non-flushing toilet that can be cleaned with organic chemicals and treated the same as any traditional flushing toilet. The

hybrid system includes multiple toilets connected to a water filled tank. This tank catches the waste and breaks it down over about 140 days before it dispels it into a leach field or a garden as irrigation. The only maintenance that the tank requires is the pumping of sludge that gathers at the bottom of the tank once every 5 to 7 years.

The hybrid toilet system is very practical for a communal toilet facility because it can be easily built for over 40 people. The size of the required septic tank would only be 1,6 m in diameter and 1,6 in height. The clarifier tank would only be 1,2 m in diameter and 1,5 m



The hybrid toilet system is a modern and clean sanitation option

high. The leach field required is a 75 mm pipe that carries the effluent to a slotted pipe placed

in the ground next to the clarifier tank above some stones. This will assist in the irrigation of the garden that occupies that center of the complex.

The cost of the EP 50 is R 22.400,00. These costs do not include the toilet superstructures, installation, transport and VAT. The excavation cost is R 2.700,00 per day. Although the cost of implementation is high, the minimal maintenance provides future sustainability for the system and saves a high amount of money over time.

ENVIRO LOO

The Enviro Loo toilet is the second consideration for this arrangement. It is a waterless sanitation system that turns human waste into compost through dehydration. The system involves separating solid and liquid waste through ventilation and heat. Basically, the occupant uses the facility to deposit their waste in a container. This container has a glass panel on the side that absorbs heat to evaporate the liquids through a ventilation tube and dries solid waste to about 5-10% of its original mass. The only maintenance the system needs consists of raking the composted material from the drying plate and placing it in a drying bag inside the unit once every year.

This toilet produces compost that can be used in a vari-



The Enviro Loo toilet system uses dehydration and composting technology to provide a hygienic method of human waste disposal

ety of ways. It can be spread in the communal garden to fertilize the land for better planting ability and will thus benefit the entire community. Another option is to bag and sell the compost, providing money that can be used to pay for upkeep of utilities or the specialist's salary.

Taps, Sinks, and the Laundry Facility

The communal water facility will have new taps, public sinks, and a laundry facility. The combined facilities will contribute to the cleanliness and hygiene being promoted in the community.

WATER TAPS

The water taps are central to the design of the new water and sanitation facility. Taps are the only source of water for the people in Monwabisi Park, and the current ones are insufficient because they are broken, dirty, and distant from many residents. At the central facility, the residents will have convenient access to taps. In order to avoid long lines, there

will be three taps in a row. If there are lines, then people can sit on the benches at the facility or enjoy the central gardens. Rather than designing hand operated taps, the new taps will have foot pedals. The pedals

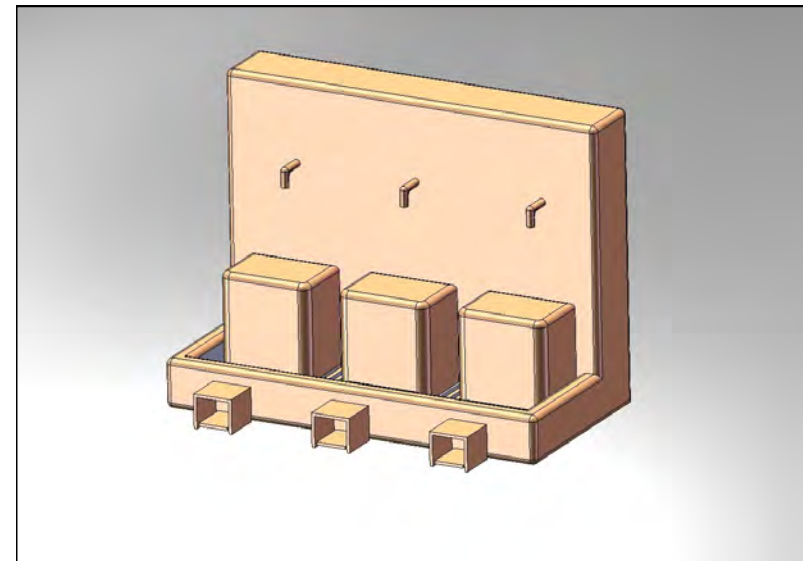
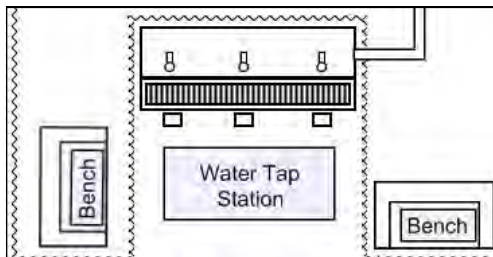

both conserve water and increase cleanliness. Many diseases are spread by contaminated taps, therefore if touching taps can be avoided, the spread of diseases via taps will be prevented. Many taps in Monwabisi Park were found leaking or left on. A foot pedal will require constant pressure for the tap to be on, which reduces wasted water. Another aspect of the tap design will be a concrete step to place the heavy water containers. A hook at the top of the tap will also be necessary for hanging the containers while they fill with water. If the taps are built to support the containers, they will not break. The improved taps will be successful because they are easy to use, conserve water, and prevent disease transmission through the municipal water supply.

SINK STATION

In order to promote hand washing, a sink will be incorporated into the design. The water will originate from the rainwater collection tanks. Soap dispensers will be used rather than soap bars so that it can be more evenly distributed. To prevent vandalism, the soap dispenser will be securely attached to the sink. The sink will be operated by foot pedals to maintain cleanliness. By avoiding hand to sink contact, the path of fecal oral transmission will be reduced. The location of the sink will be on the side of

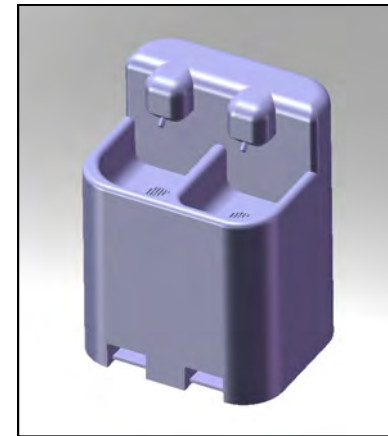

the water and sanitation specialist's house and the footpath. As a result, when people leave the facility by the footpath, they must stop at the sink to wash their hands. The proximity to the specialist's house will allow him/her to instruct those who leave to wash their hands.

LAUNDRY FACILITY

The laundry facility that will be implemented in the communal water area will be modeled after the previous one that was built at the Indlovu Centre. Because the previous laundry services were such a success, the new ones will be expanded to include six laundry stations. The reason it was successful is because people did not need to carry heavy buckets of water home from the taps to do laundry. The water used for the laundry will come from the rainwater collection tanks. The laundry facility was a safe place for people to congregate, and

the new water facility will be a larger version of that idea. The water facility will help recycle water, because it will drain into the leach field rather than being disposed of in the road. In this laundry station, water consumption is reduced because people will use less water. The long lines will be avoided by adding more stations. In the case where there is a long wait, the facility will include benches, waiting areas, and the communal garden for people to congregate. The laundry will be located beside the toilets, near the tanks, and the effluent will drain to the leach field in the garden. As a result no water is wasted in this system.

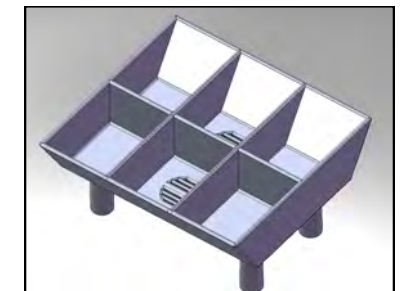
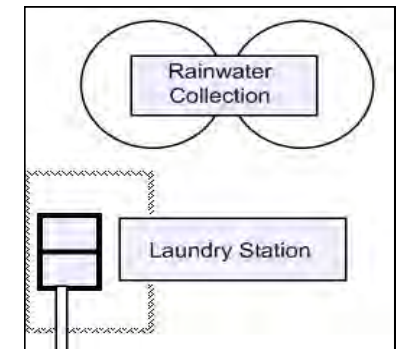

Fire Hydrants

Fire is a common and devastating problem that plagues the informal settlements of Cape Town. With thousands of homes being destroyed by fires each year, the necessity for a better fire suppression infrastructure is obvious. In order to better facilitate the needs of the fire brigades, it is essential to provide hydrants within easy access to fire trucks.

THE NEED

Fire hydrants in Monwabisi Park are sparse and inadequate. The present hydrants are hard to see and blend in well with the road and foliage. No markers exist to help find them since such markers are frequent targets of thievery. By not having clear indicators, it is difficult to find hydrants in the panic of a fire.

Fire hydrants that were installed and continue to work are few and far between; with locations and working conditions unknown even to the **city's departments. When they** cannot be found, water taps are used as hydrants. A hose can be attached to the nozzle and water is then sprayed on the fire. Since this is not the intended use of the tap there is not enough pressure to sufficiently extinguish the fire. Often, a single device is expected to provide for hundreds of houses. Since fire trucks have a limited reach with their hoses, this deficiency greatly affects the effectiveness of fire fighters. As a

result, lives and property are lost due to fire every year. When fire trucks cannot reach the flames with the hoses, there is little that can be done to stop the spread of the fire.

Water piped into the settlement flows through plastic tubing that is easy to cut and redirect, as is often done by local residents to aid in their water needs. These informal alterations greatly tax the existing water infrastructure and create a drop in water pressure as water directed into Monwabisi Park has to follow an intricate and much larger piping scheme than it was designed to handle. Pressure releasing systems, installed to reduce water pressure in the water lines during times of low usage, also hinder the efficiency of existing fire hydrants. The need for water dwindles in the nighttime hours as people tend not to leave their houses as often to gather water or use the taps in the dark. Since the demand for water is less after nightfall, the city reduces pres-



A Fire Hydrant in Mon-



A maintained and visible fire hydrant in Kruger Park

sure in the system. Unfortunately it is during the night that fires are more apt to begin since it is when candles and heating apparatuses are most commonly used. With reduced pressure the hydrants are less able to provide adequate water to quench the flames. An improved hydrant system with better pressure capabilities and

with more hydrants would save both lives and money.

INTEGRATING HYDRANTS

In the centralized water facility there will be a high pressure fire hydrant that will be maintained and easily accessible in the case of an emergency. As with other systems implemented in the facility, the hydrant will be the responsibility of the water and hygiene official. He/she will keep it in good working condition and periodically check if it provides adequate water pressure for fire suppression. Knowledge of the working condition of hydrants is crucial in the fire prone settlements and is currently nonexistent in Monwabisi Park.

Since the area intended to serve as a water center will be a construction project on its own, it would be possible to run an underground and impermeable metal pipe from the main line to the hydrant so as to reduce the possibility of tampering by community members. By having its own dedicated line, the hydrant would be guaranteed to always be functional in case of a fire. To counter the effects of the pressure reduction system on the hydrants, the water and hygiene official would be provided with a radio that would always be in contact with the city in case of emergencies such as a fire. If a fire were to occur, the official would be able to

radio the PRV stations to increase pressure to the settlement temporarily to aid the fire brigade's needs.

By installing a hydrant in the facility, its location will always be known to fire fighters and city departments. The need to search for a working hydrant will be eliminated and the fire can be easily and quickly extinguished. Vandalism of hydrants will also be reduced as the facility promotes visibility and subsequently care for the systems is increased.

Fire hydrants will be placed up front and in clear view of residents and the fire brigade as represented by the red hydrant in the integrated plan diagram. It is the hope that by providing easy access to hydrants they can be used more effectively to suppress fires in the informal settlements and eventually lower the instances of shacks burning and to save money and lives.



A fire hydrant as represented in the integrated plan

District Planning: Conceptual visualization

The area between the Indlovu Centre site and Mew Way is the oldest and most densely populated area of Monwabisi Park. Before the settlement developed this particular area was a city rubbish dump, the mark of which can still be seen today in the discoloration of the soil and even the radial pattern that can be seen in the current layout of shacks. This area represents a balanced picture of Monwabisi in that it has shops, homes and community oriented facilities provided by the Shaster Foundation.

Most recently the area has been devastated by two fires which grew out of control burning many shacks. The first of these fires burned a section of homes just behind the Indlovu Centre, reducing eight shacks in a few hours to nothing but cinders. The second fire, occurred only a few weeks later and brought down even more homes as well as all of the Indlovu Centre's Eco-Beam structures. Between these two events approximately 30% of all the buildings in this area were destroyed. Despite this terrible series of fires, people were seen the very next morning working together to clean up and rebuild their homes, this serves as testament to the determina-

tion and resilience of this community.

The main objective in upgrading an informal settlement such as Monwabisi is to improve the quality of life for all residents while maintaining the sense of community that exists today. Existing methods of redevelopment seem to focus on implementing new housing schemes throughout the area without consideration for what type of structure might exist there currently. Restructuring a heterogeneous community in this way changes its function and transforms it into a homogeneous residential area. Displacing this amount of housing entirely and rebuilding along roads designed in grid system would be frustrating for most of the residents and very costly for the project contributors. It is clear that an adapted method is needed for upgrading Monwabisi.



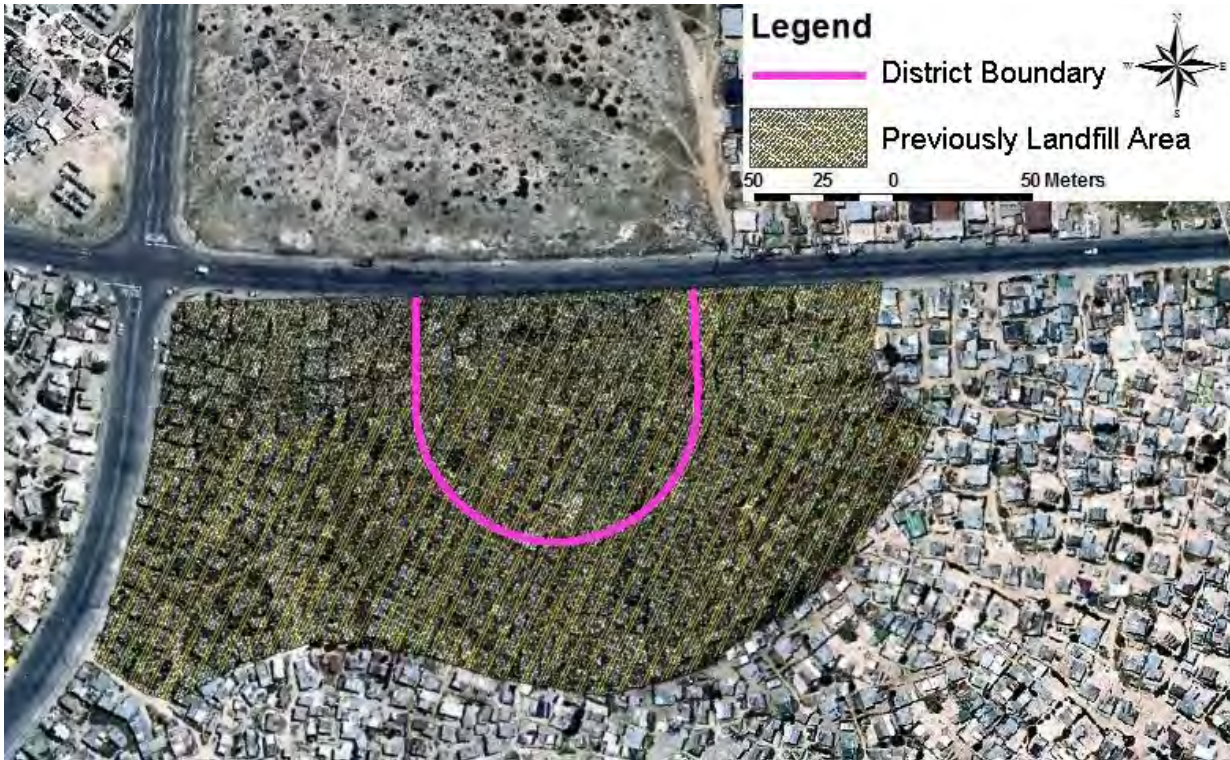

As a result of time constraints, some aspects of this vision are still underdeveloped while others we designed with a great deal of precision and detail. The result of this discussion at the district level is a clear and broad vision for the types of facilities that eventually need to be distributed all around Monwabisi Park.

The future vision we propose is an integrated strategy which utilizes existing aspects of the geography as a base for redevelopment and builds upon these with community oriented facilities. The area itself represents a “district” of Monwabisi which is embodied by the image to the left. The image and this strategy exemplify the many aspects of the redevelopment and are to serve as a prompt for future work in the

area. The image does not suggest an exact spatial upgrading plan and is not to be considered a blueprint for the district.

The strategies for the new roads system and the integration of businesses are heavily influenced by the existing conditions. Considering the current state in the development of these, and other major spatial aspects of the park, is essential to maintain the communities perception of the area and gives

residents peace of mind.

Through careful planning, it is our belief that this vision can improve safety and quality of life in the area. Also, construction of new housing will safely increase population densities while improving the living conditions. In addition to this, the strategy will provide community oriented services to all the residents, such that everyone has local resources for all their basic needs.

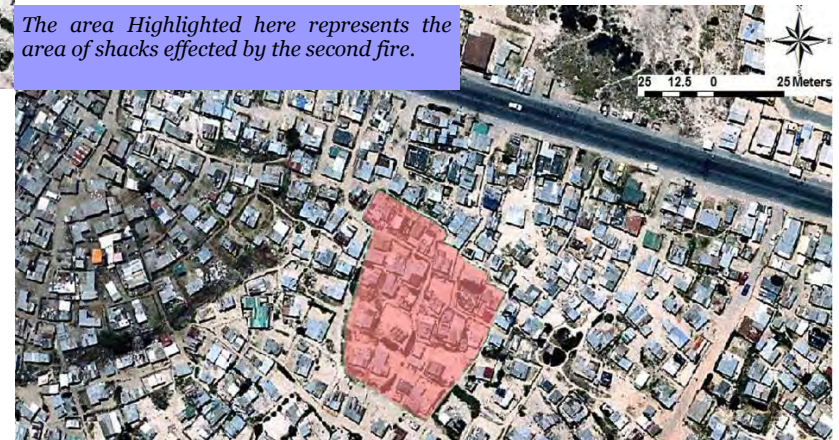

Transportation within the park:

Discussion of Roads

ROADS:

When developing a plan for a new system of roads in this area it is important to consider the existing roads and pathways as potential sites for development. Though these routes do not follow any particular grid system, they do provide a starting place for a network of travel within the park. Using the existing roads displaces the least amount of residents during the construction process and maintains the community's sense of structure, thus ensuring that the residents feel like their surroundings are familiar.

In order to lower construction costs, it would be ideal to make all the roads straight and parallel, with perpendicular intersections. Other benefits of a straight road are that they make the installation of electric and water lines much easier and they increase the distance an individual can see at street level. However, simply laying down a new grid system without respects to the existing map would negate these benefits; therefore it is imperative to take into consideration the ideas and experience of the city while maintaining the existing principles that the community identifies with. Realistically, the principle of straight roads can be applied at a smaller level such that each curved road is really a series of straight roads.

Emergency vehicle access is also very important to consider when designing the road network. According to a representative of the City, a 4.5m wide road is enough space for a fire truck to navigate comfortably. It is not only important that the vehicles can fit down the roads and maneuver around corners, but also that the trucks can service all areas of the park. Therefore the road density must be such that there are no places within the park that are more than 30m away from a road in any direction.

The shacks centered on the area between the Indlovu Center and Mew Way follow a semicircular pattern. The proposed design will initially connect two

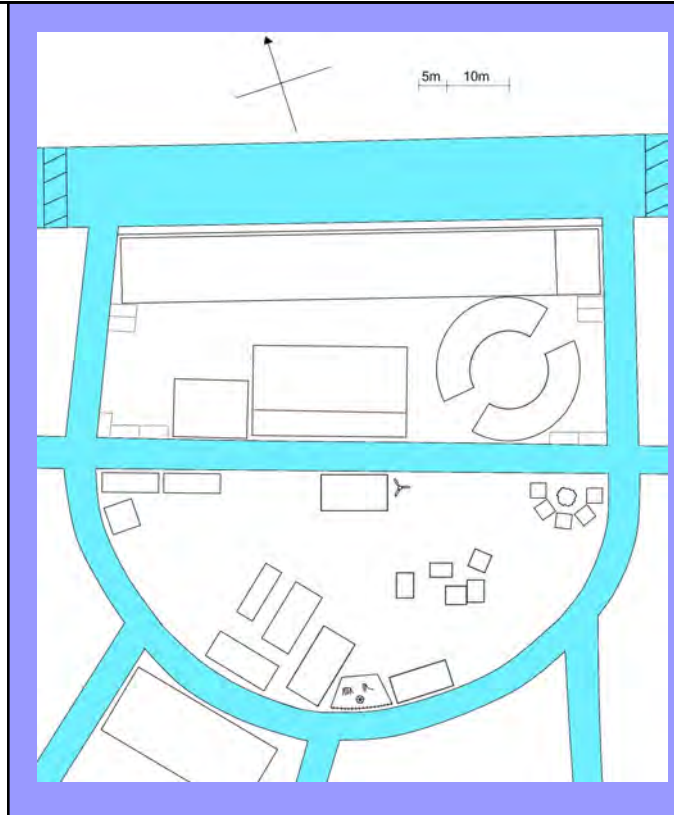

existing roads show on the left which creates a traffic “loop.” **This will improve the current state of these roads by widening them to 4.5m and providing a route for traffic to travel through the area rather than the existing dead ends.** The roads also provide proper emergency access to the entire area. Being able to access 100% of this area is a vast improvement over what exists now; the two current dead end roads only service 30% of the area.

In order to construct these roads, the space needed will first be cleared by moving existing shacks near both intersections of Mew Way. These particular

shacks will be moved into the space of the existing path so that the new road will utilize the space the shacks used to occupy, thus making the road's path more direct. Other shacks, particularly those where there currently is no road of any kind, will have to be moved in this manner or even removed and replaced by more space efficient housing. These roads will encourage more pedestrian and vehicular traffic in the area which will benefit the local economy. In addition to this, the roads will provide better access to the Indlovu Centre which will be extremely beneficial to the social network of Monwabisi Park.

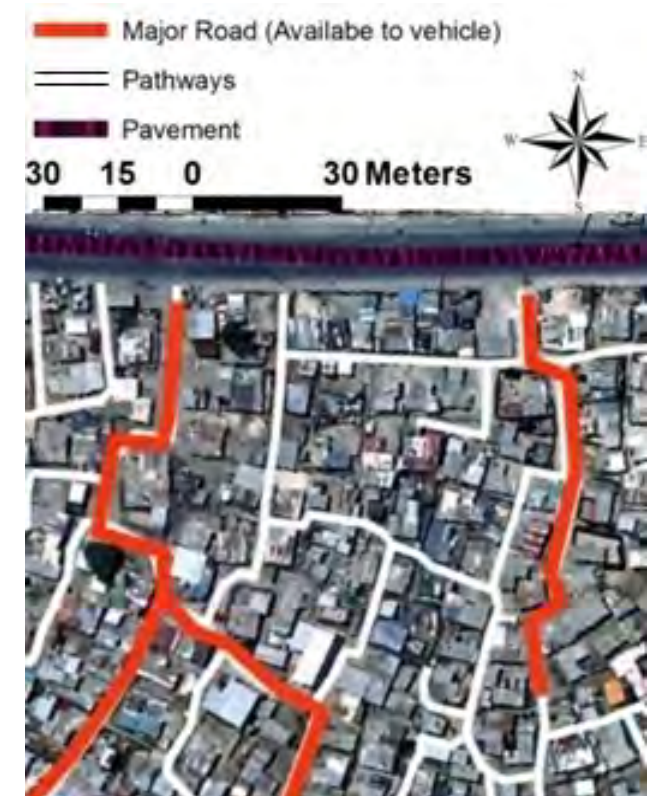

Transportation within the park:

Discussion of Speed Bumps, Bus Stops, Lights and Sidewalks

SPEED BUMPS:

Incorporating speed bumps into Mew Way is an easy way to improve safety in the area. Pedestrians in particular are at risk when traveling along most major roads. The vehicles traveling on Mew Way tend to be moving much faster than normal because of its length and how straight it is. The increased speed causes more accidents and pedestrians, without a sidewalk are inherently at a much higher level of danger than necessary.

Incorporating speed bumps and sections of irregular surfacing on the roads will reduce the average speed of the automobiles and will improve safety for pedestrians and drivers alike. The speed bumps themselves can be anything from a simple rise in the pavement as small as a meter long and at intervals of every few hundred meters or so. While the larger sections of alternate surface can be made of brick or cobble stone and might be ten or twenty meters long. Because of costs the most efficient method would be to use the raised pavement more regularly. However, the irregular surface could be used at areas of higher importance, like just outside of major entrances, particularly the area on Mew Way in front of the school that exists in Harare.

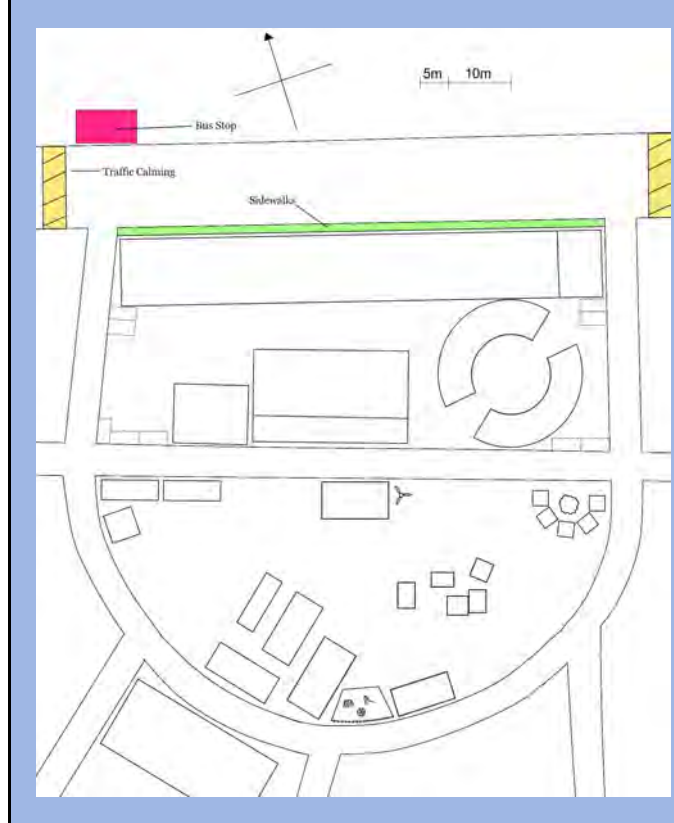
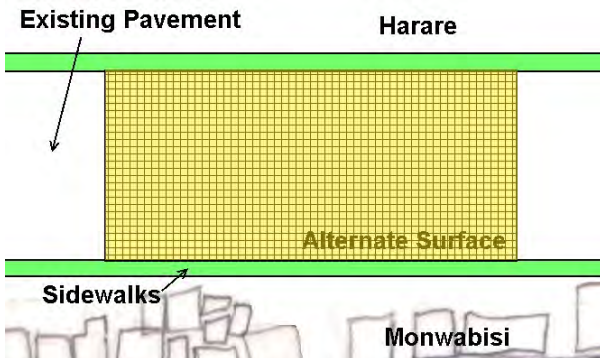

BUS STOP:

One bus stop already exists along Mew Way (indicated above) this type of facility could be replicated in several other places along Mew Way and reduce the distance that individuals have to walk. The bus stop is a simply designed small enclosure or even just a sign which identifies the location for the bus driver and pedestrians alike. For information on bus stop locations please refer to "Endlovini."

LIGHTS:

The Current lighting in this area is nearly adequate but throughout the rest of the park it is far below standard. Merely fixing the existing lighting system so that it functions at 100% would more than double the amount of light in Monwabisi. However even with the existing lights working at full capacity only about 40% of the Parks surface area is covered by suitable lighting. Incorporating street lights along the proposed road structure would increase lighting in Monwabisi significantly. The standard street lights would be most needed at intersections and near large areas of congregation such as the Indlovu Centre. More lighting could be added as needed after these particular areas were covered. Another consideration is that the Individuals houses would have their own lighting such that ideally the front door and the area in front of the residence would be covered. This system would require the individuals to take on the maintenance and would remove some of the burden from the city.

SIDEWALKS:

Currently there are no formal sidewalks anywhere in Monwabisi Park. The need for the types elements which cater to pedestrians is much greater than those which facilitate everyday automotive access simply because not a lot of people in Monwabisi drive their own vehicle. Using Sidewalks on major roadways is a proven and effective solution for improving safety in an area with high traffic. Sidewalks in this area will provide room for customer traffic along the businesses which already line Mew Way. Also when integrated with the lighting system they will present the safest route for travel during night time.

Commercial Business Areas:

Areas within the seed redevelopment area designated for businesses that will help bring Rand in and keep it circulating within the community

COMMERCIAL BUSINESS SPACE:

The commercial business space is located along Mew Way, a main road running through Khayelitsha. This provides a main commercial area where many residents go when in need of goods and services. Businesses that are located along the sides of the major roads surrounding Monwabisi Park are popular because many people within the community travel and take public transportation which is located on these roads. Street-centred businesses provide quick and convenient places for locals to pick up food and other necessities on a daily basis.



A local business currently being operated on Mew Way

ECOBEAM FACTORY:

The EcoBeam factory will be one of the key redevelopment industries utilized to create jobs within Monwabisi Park and bring Rand into the community. The Eco-Beam factory is located at a main intersection to allow for easy pick up and delivery of materials. The Eco-Beams being produced will either be purchased by the construction teams working for the redevelopment effort within Monwabisi Park, or be purchased for other uses by EcoBeam.

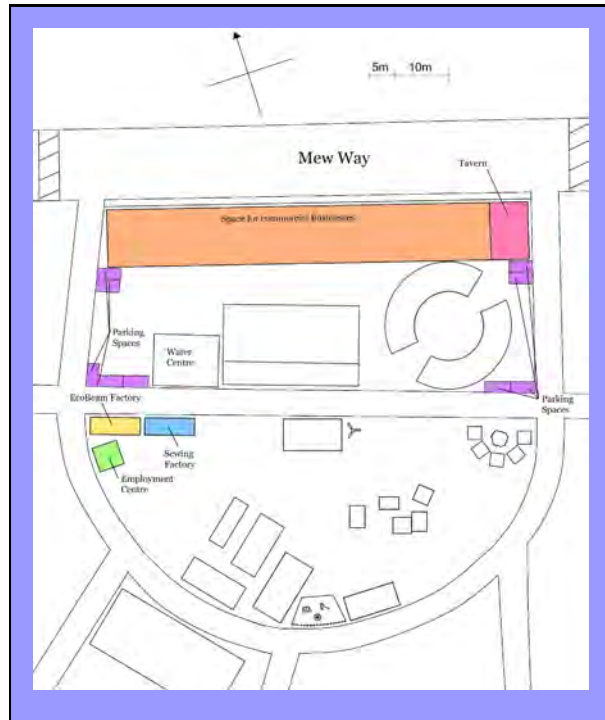

PARKING SPACES:

Parking spaces are small areas along the major roads allocated for local community members and visitors to park their vehicles. Parking will cost R25 a day, and all income will go in to the community fund.

TAVERN:

A tavern, also known as a shebeen, is the local informal bar. They are often the centre of social interaction, and are frequently equipped with pool tables, music, and African beer. The tavern is located at the corner of Mew Way and another large roadway near residential areas, allowing for easy access and safe travel.

SEWING FACTORY:

The sewing factory will be another one of the key redevelopment industries utilized to create jobs within Monwabisi Park and bring Rand into the community. It is located directly next to the EcoBeam factory along a main road to allow easy pick up and delivery. The sewing factory will produce the bags to be filled and used in the buildings being constructed for the redevelopment effort in Monwabisi Park. Bags not used within the park will be sold to EcoBeam to be used on other projects. In addition to producing sand bags, the sewing factory will be available for community members to learn how to use the machines, and eventually for them to sew their own items such as clothes, blankets, and pillows. Other projects such as doll making and clothing design could also be operated out of such a structure when the sewing factory is not in operation.

EMPLOYMENT CENTRE:

The Employment Centre's main purpose is to help match up job opportunities with workless residents of Monwabisi Park. The two primary roles of this division is to act as an employment agency and find help people who need a job in MWP to find work. The Employment Centre will also keep a directory of people who come to the centre looking for work and what skills they have and would like to learn. The benefits of this are two-fold: first, this will help to match up people within Monwabisi Park with jobs and secondly, the information about what skills people would like to learn can be used by the Skills Development Manger. This skills development manger will be responsible for coordinating and planning various skills development seminars. These seminars should bring in professionals so that MWP community members can learn the skills that are necessary for redevelopment and broaden their skill base therefore opening them up to new job opportunities. These two positions will work together to both train people with essential skills and to match skilled workers with jobs.

Playground and Community Safety Centre:

PLAYGROUND:

A playground located safely between the Indlovu Centre and the Community Safety Centre would provide another location for children and parents to go during the day. Unsupervised children could go to this area during the day as well to be in a safe area and receive supervision from other community members in the playground or near the Indlovu Centre. Children often play in the streets during the day currently and this area would provide an alternative to this for young residents of Monwabisi Park.

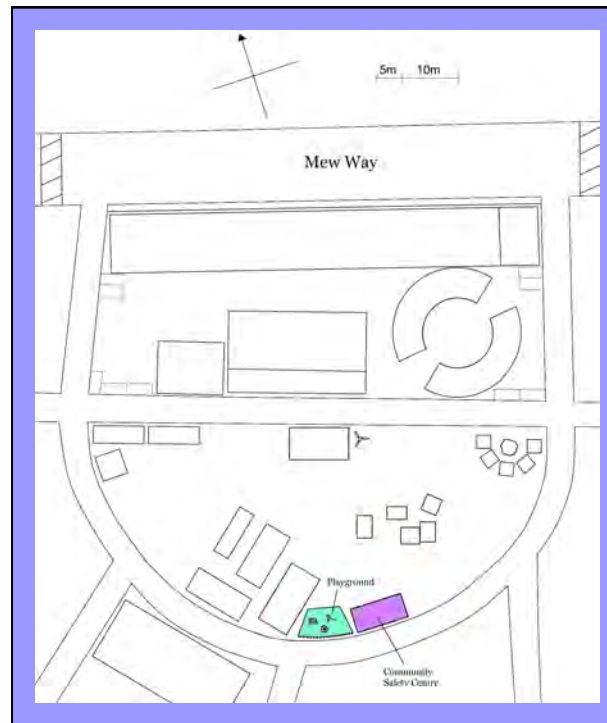

COMMUNITY SAFETY CENTRE:



A community safety centre located near the Indlovu Centre will be a location where a police and rescue presence can be formed in the Park. A police officer of some form can be employed here to help increase safety in the area. This centre could also be a location where support for domestic violence or other community safety issues could be found.

Cluster Housing:

One way to make better use of space in redevelopment is to incorporate cluster housing.

ROW HOUSING:

A simple row housing concept has two stories and would rely on an external water facilities. This design takes into account the need for individual outside space. A designing charrette was held during the research period and many design ideas were taken from that design session and incorporated into the design. During the design period street committee member were present to give important feedback on different designs. One important aspect that needed to be included is the need for parking as well as space to drive a vehicle. This main concept was incorporated into the row housing design. Included in the design is a series of five households. Each household has a lounge area included leading into a kitchen area. Going up to the second floor is the bedroom area and incorporates a master bedroom as well as children's bedrooms. It was mentioned during the design process that the master bedroom must be located at the front of the home to watch for suspicious activity. This was a very important design aspect and was incorporated into the design. In the front of the home is a small garden area that can be used for clothes washing and any other additional activities.

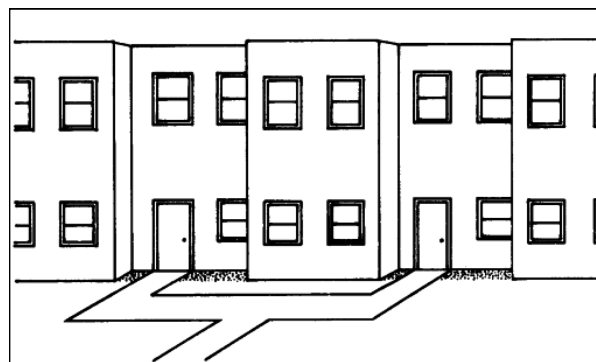
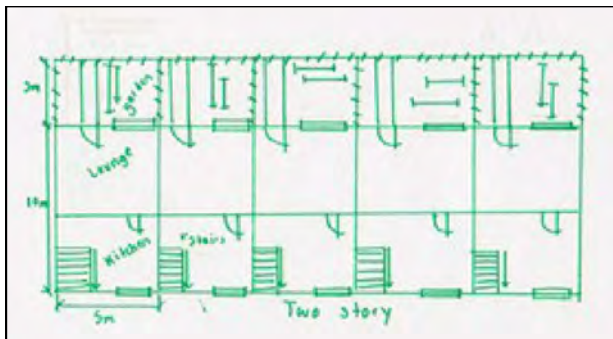

CIRCULAR CLUSTER:

The circular housing design encompasses all the same ideas as the row house. No family can live above another and each family will have their own yard space. The homes in this structure will be 4m x 5m and will incorporated the kitchen and living all in one area. The center area can be used for a communal garden or other community activities. A water facility can also be incorporated into the center of the design. The design of the structure is ideal because it not only creates open space in the center but it also provides security for the residents within the structure. The roof on this structure is slanted upward which causes wind to go ovetop of the structure and completely avoid the center communal area. This makes it an ideal spot to play or grow plants. A central path can be located through the center of the structure so although it feels like a common pathway it will still be very secure.

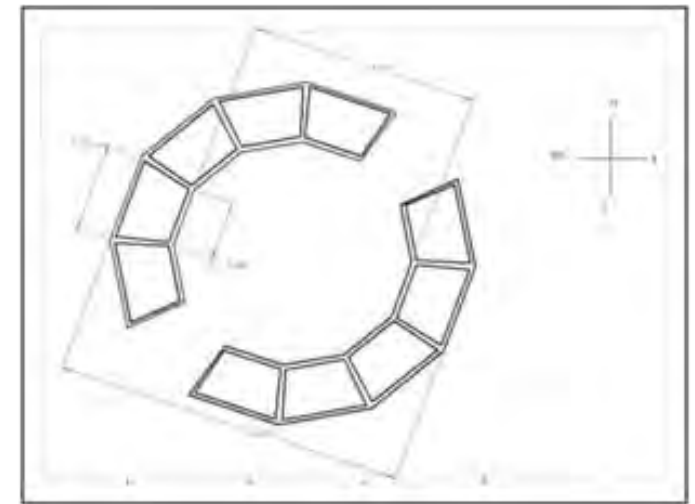

Existing Shacks:

Some redevelopment will incorporate reorganizing the layout of existing shack designs.

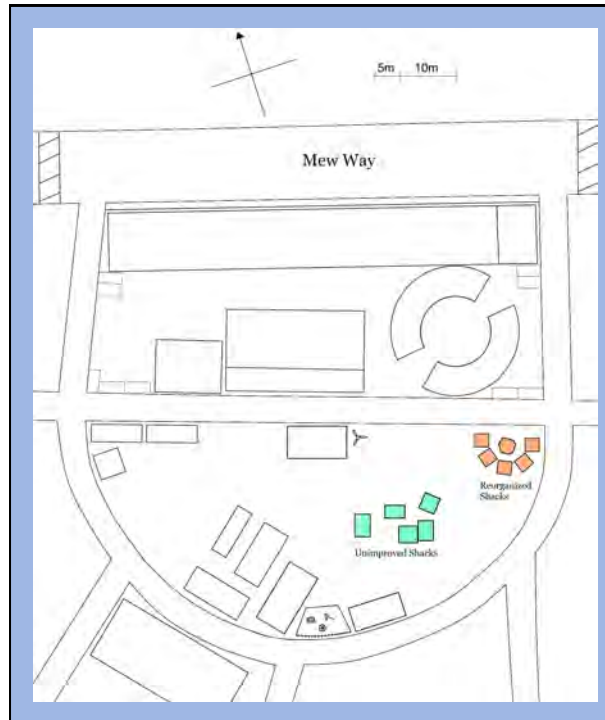

UNIMPROVED SHACKS:

Majority rules; minority rights. In keeping the redevelopment focused intensely on community, it must be taken into consideration that some people are content with their homes in their present condition. Space needs to be accommodated for the homes of people who do not wish to partake in the Ecobeam upgrade initiative but are still part of the community, and as such will receive the full community benefits of the redevelopment process.

REORGANIZED SHACKS:

As a segue towards clustered housing schemes, there will likely be a portion of the population who opt to have a house of the same dimensions but of better materials. An area will be reserved for these homes, and will preserve the innate geometry of each structure. The buildings will showcase the Ecobeam materials and the entire area follow a layout that is agreed upon by all members who live there.



Energy Centre:

Located in a central location, this centre will provide energy related products, services and information to residents.

ENERGY CENTRE:

In the center of the district area will be the Alternative Energy Centre. It will be a central facility that will provide essential services, products and information to the residents in the area. It will have a focus on sustainable energy alternatives, to promote energy conservation and renewable energy production and use.

INTEGRATED ENERGY CENTRES

An idea such as this has already been tried by the Department of Minerals and Energy. Called Integrated Energy Centres (IeCs), these facilities are one-stop shops for a community's energy needs. They sell basic energy products, including petrol, LP gas, paraffin, and candles. They function as a community coop, employing between 5 and 10 full time workers.

The products sold at the IeC are bought directly from suppliers, eliminating the middle man, and driving down costs for the community. As well as providing cheap products, a core goal of the IeC is to provide important information about energy practices. IeC employees provide training to consumers about safe use of paraffin and LPG. Paraffin is also sold in regulated safe containers to ensure safety.



Caba Mdeni Iec in the Eastern Cape

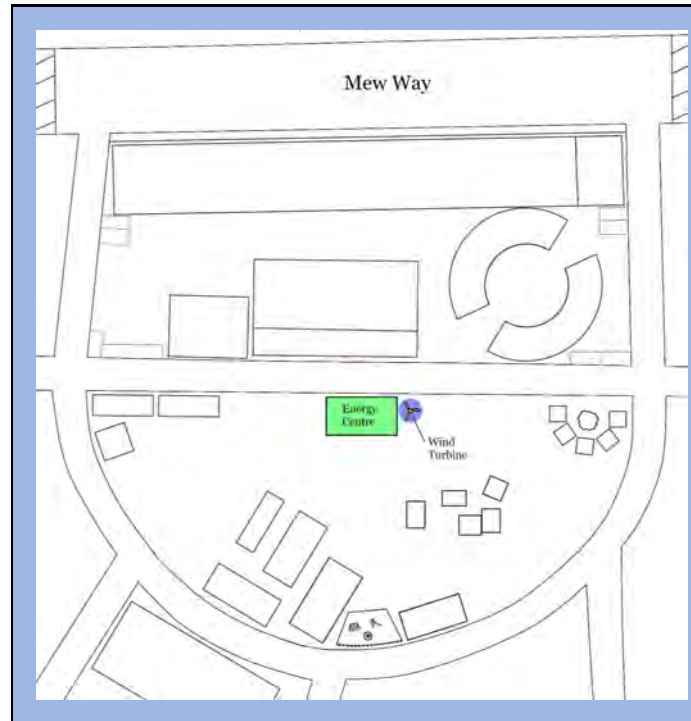

Requirements for an Alternative Energy Centre

- Employed Energy Specialist
- Informational Brochures
- Cooking/Heating Fuels
 - Paraffin
 - LPG
 - Ethanol Gel
- Cooking/Heating Equipment
 - Primus Type Paraffin Stoves
 - LPG Stoves
 - Ethanol Gel Stoves
 - Hot Boxes
 - Solar Water Bags
 - Insulation Materials

ALTERNATIVE ENERGY CENTRE

We would like to propose the creation of a facility similar to the IeC, but with a focus on sustainable alternatives. To be of maximum use to the community, the facility would provide services and products for the current energy practices in Monwabisi Park. One or more “energy specialists” would need to be trained to understand both new innovations in energy usage, but also the safe use of current practices. While new energy ideas need to be encouraged, current practices must be respected and provided for.



The energy specialist will be equipped with information on hot boxes, solar hot water bags, and wind turbines. Knowing about these technologies, and working at a central facility, he will have the ability to have contact with many members of the community, and have the maximum influence on people's energy practices.

Residents could also use this facility to have an electricity audit preformed, where the usage of each electric appliance is evaluated and the monthly cost of each appliance can be calculated. Most residents lack the necessary skills to assess the details of their electricity use, and the energy specialist could assist those residents interested in conserving electricity.



The alternative energy centre would also provide actual products for the community. They could stock alternative cooking stoves and equipment, as well as alternative fuels to paraffin, such as LP gas, or ethanol gel, which is a much safer and more efficient cooking fuel.

CENTRALIZED HOT WATER FACILITY

There is a need in any community for a hot water supply. Currently in Monwabisi Park, residents heat water for bathing and cooking with electric or paraffin stoves, or an electric kettle in some cases. Solar Water Heaters provide a sustainable source of hot water with no fuel costs. The logistics of installing Solar Water Heaters on shacks, or even on redeveloped housing units, however, are such that we would not recommend attempting to provide SWHs to individual households. They are heavy, expensive units, and would require plumbing to each home. Monwabisi Park will not have plumbing run to households any time in the near future.

These factors make the idea of having each home equipped with a solar water heater unrealistic. A more feasible idea would be to have a centralized facility that could provide hot water to a portion of the community. A single building with enough roof space to fit

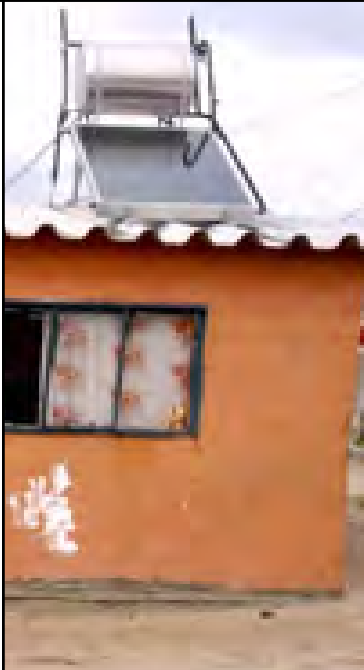

multiple heaters could generate a great deal of hot water. This water could be provided to people in insulated carrying containers. A polystyrene-filled cloth sleeve, similar to the construction of a Hot Box, could be cheaply made to fit over the buckets they currently use to transport water. People could pay a minimal fee to have access to this water, helping somewhat offset the initial capital investment, or provide employment to someone working at the fa-

REQUIREMENTS FOR CENTRALIZED HOT WATER

- Multiple Solar Water Heaters
- Roof Space for SWHS
- Piped water supply for SWHS
- Plumbing to run water to faucet
- Bucket sleeves to insulate hot water
- Employee to distribute hot water

cility. The idea of centralized hot water was introduced to some members of the Street Committee during a charrette, and it was well received.

WIND TURBINE:

Wind is often source of discomfort in Monwabisi Park, bringing cold air into shacks in the Winter, and filling homes with blown-in sand during the

ESSENTIAL QUESTIONS REGARDING INSTALLATION OF A WIND TURBINE:

- How many buildings/people need to be service by the turbine?
- Will the service provided by the turbine be worth the large initial capital required?
- Should the turbine be used to power homes or community buildings?
- What operational/maintenance staffing will be required to operate a wind turbine?

dry season, but these high winds could also be a valuable resource to the community. Located in the center of the district area, the alternative energy centre is a suitable location for the turbine. With a high initial capital investment, the turbine could be used to power the necessary appliances in the alternative energy centre. The energy specialist, who is housed in the centre, could be trained in proper maintenance and operation of the wind turbine.

A source of wind power, depending on the power it generates, could provide for the community in different ways. The power could be used to power the energy centre, and other community buildings, like the buildings of the Indlovu Centre, or it could provide for a small group of homes in the area, generating revenue for the community. Regardless of how the energy is used, a wind turbine would help the residents of Monwabisi Park become more sustainable, and help relieve the already overtaxed Eskom grid.



Aeolus 3Kw wind turbine sold for R 50 000

Endlovini: Planning on a Community Wide Scale

When planning for the spatial redevelopment of Monwabisi Park, it is vital to take into account that the amount of vacant land is within the accepted boundaries of the park is extremely limited. With this in mind, it makes any sort of large scale relocation unfeasible without being extremely detrimental to the community.

Any large scale plans will take a significant amount of time to implement. Rather than focusing immediately on housing as previous efforts have done, it is more beneficial to strengthen the community first. A stronger, more unified, more informed community is much easier to work with once plans require significant community support. Under this pretence, the following section will present concepts for successful spatial redevelopment in Monwabisi Park.



Community Centres:

Considerations for the implementation and selection of future Community Centre sites.

There is currently only one community centre within Monwabisi Park, and it cannot service the entire community. Due to this deficiency, the community would benefit tremendously from the creation of more community centres. By placing a community centre in each section the needs of the community would be better met, and it would be easier to gain support of community leadership to do so.

Important Considerations For New Locations of Community Centres

- 1.) Location within section
- 2.) Proximity to existing roads
- 3.) Amount of displacement required
- 4.) Location with respect to know problem areas

When determining potential locations for future community centres it is important to consider the following factors:

Presuming that each section is getting a community centre, it is important to keep each centre centrally located within each section because the



Sign at the entrance to the Indlovu Centre, the only community centre currently in Monwabisi Park. It's location in C Section, and is sponsored by the Shaster Foundation.

community views this as the fairest location as it provides equal distance for access. Due to a fairly consistent housing density within each section, this assumption is reasonably accurate. It is also important to keep community centres centrally located in order to keep the centre secure, and to make the community safer. Most of the crime in Monwabisi Park is that of opportunity committed by people from other sections

or areas. Thus if the park is within the community it is easier for members to take ownership of it. The increased traffic to the centre within the section also means that there are more people there to prevent crimes of opportunity.

Proximity to existing roads is also an important factor in determining location. In order for new community centres to be built, it will be necessary to bring in large amounts

of supplies. Roads also provide access to the centres, as many types of traffic need to be able to reach each section: emergency vehicles, as well as commercial and residential traffic. Thus, situating community centres along existing roads allows for the necessary access without the additional cost and difficulty of making new roads and displacing additional people.

Any open spaces that currently exist should also be noted, as they would be able to accommodate a new centre with the least amount of shacks displaced. If these centres are isolated efforts (in that there no immediate plans for new housing), then relocation becomes a major issue. Community members are generally extremely reluctant to move their shacks unless doing so presents a direct benefit such as new housing or improved utilities.

The final consideration is creating a safe space around each centre; utilizing an open area with the least amount of dark corners, far from the brush, and with accessibility to electricity for lights is essential. A location in each section that is along a major existing road, in a relatively central area, and away from dangerous areas,

would be the best possible site for the future community centre facilities.

Community Centres:

Considerations for the implementation and selection of future Community Centre sites.



SUGGESTIONS FOR SPECIFIC COMMUNITY CENTER LOCATIONS

As the Indlovu Centre is currently established within C Section, there is no reason to rebuild in a new location. Each of the other sections however have their own set of concerns when planning for a new community centre.

For M Section, there are a few major factors to consider. The bushes, dump site, and graveyard along the back of this section all present serious dangers, so the centre should be closer to the road than the back. In terms of existing roads, **there aren't any that provide access across M Section.** There are few short paths wide enough for cars along Mew Way however, so to diminish the amount of houses required

the centre should be located along one of these paths.

Section A is slightly easier to determine a space for a community centre. There is a road which stems off from the back road of Monwabisi Park and divides the section in two. The area along this road is less densely populated, and has room for a centre without dis-

placing a large number of shacks. Key safety issues are the bushes around the back and eastern sides of this section, however by placing this centre centrally there is a sufficient buffer between the two.

Section B Shares similar issues to the previous two in terms of the danger presented by the bushes at the rear of the park. What sets section B apart

from the other sections is that there is a school directly across the street in Harare. By placing the community centre close to the school, it would mean that kids would have to travel less distance after school, and create a safer atmosphere around the school. Placing a centre here would provide more justifi-

cation for speed bumps of some sort across from the school where there are currently a significant number of accidents.

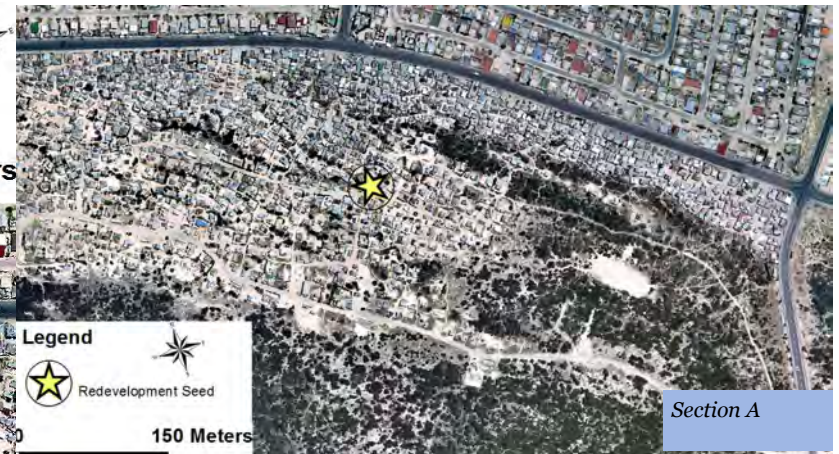

from the other sections is that there is a school directly across the street in Harare. By placing the community centre close to the school, it would mean that kids would have to travel less distance after school, and create a safer atmosphere around the school. Placing a centre here would provide more justifi-

Central Road:

Considerations for a main route which connects each of the sections through the interior of the Park and provides ample access to the area.

PROPOSED “CENTRAL ROAD” CONSIDERATIONS

Residents generally only have three options when they want to travel to another section of the park: Mew Way, the perimeter road on the back of the park, or weave through the pathways and around shacks in the middle of the park. None of these options provide an easy travel choice for community members, and the majority of people in the park end up taking a route that is much longer than necessary; in doing so are wasting time and putting themselves at an unnecessary risk.

In addition to this there is a safety concern with the existing methods of travel. Mew Way offers a direct path but it is on a busy, dangerous road where motor vehicle accidents are common because of the vehicles can travel at high speeds. The perimeter road is less direct than Mew Way, with a lot less traffic but it is near the bushes at the southern end of the park, in an area generally considered unsafe by the community because of the potential for muggings. Finally, the method of travel between shacks is very random and provides no safety from the dark corners and brush throughout



the park. A central road parallel to Mew Way, which bisects the Park, will open access to new areas and shorten travel routes within the park while decreasing all of the aforementioned risks of the current travel methods.

Among the most immediate benefits of the central road is that it can improve safety within Monwabisi Park. The new road will provide more visibility than small footpaths, keep travelers away from the dangerous bushes, and follow existing paths so that vehicles **can't travel at high speeds** as they do on Mew Way. The road will also provide opportunities to build more business and

community facilities. These facilities, in turn, will increase the foot traffic along this road, stimulating the business growth and aiding the economy. The central road could be seen as a catalyst for economic and social development in Monwabisi Park. Furthermore, the road will serve as the central line for the rest of the **park's infrastructure; with respect** to the existing pathways, other roads will be built to connect the central road to Mew Way and the perimeter road at the back of the park.

IMPLEMENTING THE CENTRAL ROAD

Regardless of the fact that the central road will closely follow the existing pathways, the construction of the road will take a long time and will displace many residents. Since **this road doesn't offer immediate** benefits to the current state of education, child care, electricity and water, it is uncertain whether or not the community members will be in full support of its construction. However, this road does offer improvements in safety, ease of travel and local economy, therefore has the potential to vastly improve the lives of residents in Monwabisi Park.

Relocation Principles:

Considerations for moving residents and potential sites for new housing and other community facilities

Relocation of people in informal settlements has in, in large part, ended with failure. In many instances it is hard to get people to leave their temporary housing once construction **is complete, people don't want to move** in the first place, or people just leave entirely once construction starts. When construction is over, the community is entirely different than before, and in many cases the change is not positive.

With such a high density of houses within Monwabisi, it is unrealistic to presume that new housing can be built entirely without relocation. With this in mind, community members were more willing to relocate given the following concerns:

- 1) Improved Housing
- 2) Proximity to their current shack
- 3) Improved utilities
- 4) Single Move
- 5) Safety of New Area

If residents were to be relocated, they want to stay relatively close to where they currently are. Residents were also unwilling to move to an area without electricity. To this extent community members also unwilling to move away from

water sources.

If these concerns were met, residents were willing to move for improved housing as long as it was relatively close in order to preserve their community. The new area would also have to be safe. For example, residents were unwilling to move from a well lit section to an area bordered by bushes. Most importantly however was the idea that if they were to move, residents did not want to have to move a second time.

SINGLE MOVE RELOCATION

Single move relocation requires a few things in order to succeed, namely open space and efficient housing designs. New housing could be constructed in an open space in a manner which could fit into a large scale organizational plan, and while using less space than the shacks they are replacing. As this method progresses, it has the potential to free up significantly more space than the initial open area.

With this in mind, Monwabisi Park has very little room to expand, as it is currently on a



nature reserve. There are however two areas enclosed by the back border of the park which could serve as relocation sites. These sites are roughly the size of redevelopment seed. If electricity and lighting were to be brought to the back of the park (a major community concern regardless of relocation), then people could be shifted back into new housing, which would

create more space than the original open areas had to offer. In this way new houses could be built over time without any major relocations, and in doing so would create excess free land for more space consuming community facilities such as schools, soccer fields, industrial sites and more community centers.

Relocation Principles:

Considerations for moving residents and potential sites for new housing and other community facilities

SOCCER FIELDS, SCHOOLS, AND LARGE SCALE COMMUNITY FACILITIES

As there is extremely limited open space in Monwabisi Park, there are few options for building facilities which take up large amounts of space. While these areas could be used for this purpose should a reason arise, it would be much more beneficial to the community to utilize the single move relocation outlined previously.

There are several advantages to this approach. Like the community centers, placing communal facilities in areas surrounded by residences, rather than along the back of the park enables the community to take ownership of them. This means that the facilities would be surrounded by people who care about their maintenance, as well as the safety of those using them.

If such an instance arose where there was funding for such a project, a school is a major desire within the community. The closest school is in Harare, meaning that children have to travel long distances to receive an education. Recrea-



tion areas are also a desire, as there is currently no space for this use.

Possible locations of both a school and a soccer field are shown in figure (). The school is centrally located to provide equal access for everyone in the park. The soccer field is also located, but is located along the back of the park as a possibility for immediate implementation should that become a possibility

Making it Happen: An Integrated Plan for Local Economic Development

After seven weeks of researching sustainable redevelopment and another seven weeks of fieldwork in Monwabisi Park, the economy team has created a plan for local economic redevelopment of Monwabisi Park. This plan for redevelopment focuses on how the development of new housing can stimulate local economic growth, job creation and skills development. The plan for redevelopment also investigates the creation of a local job bank that will include jobs that are created locally through redevelopment, and jobs that are available outside of Monwabisi Park. The last aspect of the WPI plan for redevelopment is the use of a complementary currency system to help stimulate local economic growth. The economy team hopes that the ideas that are presented in this plan can be used by the Shaster Foundation to assist with the brainstorming and development of a plan that is embraced by the MWP forum and also used to acquire outside funding. Many of the ideas presented in this plan for redevelopment were created under the assumption that the Shaster Foundation will be able to acquire outside funding to help finance the basic investments needed to jump-start local economic activity and redevelopment.

WHAT'S BEEN DONE

The city of Cape Town has been doing major redevelopment in the informal settlements surrounding the city, but there are some basic oversights in their current approach. First, their efforts are geared toward giving housing to people in informal settlements based on a waiting list. Years of systematic discrimination by the government has left community members without alternative employment and housing options. With few and limited opportunities for employment community members are left without the ability to raise adequate funds for private home purchasing. This creates the undesirable expectation among informal settlement dwellers that housing should be provided for free, and by waiting long enough they will receive the upgraded housing. However, it is clear that this

waiting list method is not working. According to Alistair Graham of the VPUU, the Cape Town government has the capacity to produce only 10,000 households per year with a waiting list of 250,000-400,000 households to build. Therefore, it is critical that the government modifies or expands its current approach toward rebuilding informal settlements in order to break this undesirable expectation. The economy team proposes the establishment of a community oriented redevelopment effort that is founded on the labour contributions of individuals.

There are many aspects of the structure and process of the government issued housing that need to be addressed as well. Currently, the houses are built as individual cinder block units; while they are fireproof, they offer poor insulation and a fairly unattractive appearance.

The individual housing unit structure offers no densification factor, which is a major issue when redeveloping informal settlements comprised of exceptionally dense housing. While there is a large amount of land in the Khayelitsha area, with the current redevelopment structure, there may not be enough land for complete redevelopment. In addition to the densification issues, the process of constructing the homes needs to be changed. Currently large numbers of people are forced out of their homes in order for them to be bulldozed and redevelopment to occur on top of them. People are then moved back in to the homes with no attention being paid to who lives where. During this process, community ties are broken as they are split up and people often end up living next to strangers. This process commonly leads to family members

living 10-20 kilometres away from each other. With the diminished community of the redeveloped areas, people feel no pride in their neighbourhood and no need to develop it further, often leading to violent and dangerous areas.

In addition to the features

and process of the redevelopment having flaws, the contracting of construction needs to be re-evaluated. Currently, contractors from the formal market are generally being used at a great financial expense to the city.

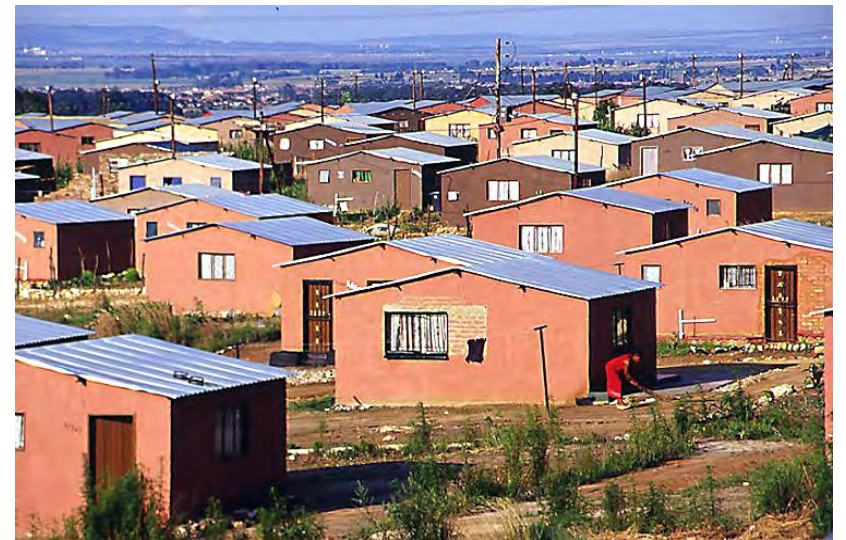

Government Subsidy Housing in Cape Town, South Africa

The Costs of a Community Redevelopment Approach

As in any redevelopment, a significant amount of funding and investment is necessary to begin the process. In Monwabisi Park, the first area to be redeveloped is known as the seed area, and many of the proposed buildings for this area will be community spaces. This page explores the costs of the individual buildings leading to the overall cost of redeveloping this communal space. These costs take into account the materials necessary for the construction of these buildings; however the labor costs are not considered as it will be sourced from Monwabisi Park residents.

To produce the EcoBeams required for the complex this will generate 85 hours of labour and 777 hours of construction time for framing. All in all, an investment of approximately 98,000 Rand will produce about 1,214 hours of labour and skills training for local people within Monwabisi Park.

While this is an efficient mode of building houses because they are very skilled workers, it is not beneficial to the informal settlements in any way. Contracting the redevelopment from within the settlement would have numerous benefits for both the city and the people of the settlements. Using internal labour would bring the cost of redevelopment down drastically as the people living in informal settlements are willing to work for much less than people in the formal economy. Also, the influx of Rand created by adopting this strategy would help to develop the informal market. Using

internal labour would also help to develop skills of the people of informal settlement, allowing them greater opportunity to get a job in the formal market. As skills are developed within the informal settlement, the redevelopment can happen faster because the workforce will grow as the construction is sourced from the communities.

This project focuses on creating an economic plan for a potential redevelopment effort to be implemented in a small area of Monwabisi Park.

MATERIALS COST AND LABOUR HOURS BREAKDOWN

In order to provide a rough

estimate as to how much the redevelopment will cost the WPI team worked closely with EcoBeam, the VPUU and the Water and Sanitation Department of Cape Town to generate a realistic estimation of the materials cost and labour hours required for the redevelopment. Although these numbers are just estimates, they provide a clear idea of what kind of investment would be needed to provide the fundamental community resources that are necessary for successful redevelopment.

Using information collected from EcoBeam the project team inferred about how many local labour hours will be generated for the construction of the six-unit housing structure proposed in Chapter ^. It is estimated that in order to produce one of the six-unit housing complexes proposed by the project team about 10,000 sand bags will be required, producing about 176 hours of sand bag sewing labour and 176 hours of sand bag filling labour.

Materials Cost Breakdown for Redevelopment		
Community Centre & Clinic	ZAR	900,000
Creche	ZAR	170,000
Montessori School	ZAR	170,000
Elder Services	ZAR	18,000
Guest House	ZAR	50,000
Relocation Centre	ZAR	18,000
Water & Sanitation Centre	ZAR	112,000
Residential Housing (23 Units)	ZAR	411,000
Six Unit Housing Complex	ZAR	98,000
Roads	ZAR	360,000
Total	ZAR	2,307,000



Rendered view of proposed 6-unit housing complex



Photo of Makazi's Guesthouse



Photo of the Indlovu Crèche

Labour Hours Required for 6-Unit Housing Complex	
EcoBeam Factory	85
Sandbag Sewing	176
Sandbag Filling	176
Construction	777
Total	1,214

Redevelopment Through Community Labour and Involvement

Throughout the course of seven weeks of fieldwork within the community of Monwabisi Park, the WPI team was able to identify housing as one of the most sought after needs for redevelopment within the community. In order to deliver sustainable housing and also jump-start local economic growth the economy team identified three key industries to be established within the community. The three industries explained in detail throughout this section will not only bring new jobs and skills to the community, but will also instil a sense of pride and ownership to the overall economic redevelopment of the community.

THE ECO-BEAM WAY

Eco-beam technologies has developed an extraordinarily simple way of manufacturing high quality, safe, housing that requires minimal materials and facilities. The Eco-beam system is practical and does not require electricity at the construction site, which lends nicely to developing in informal settlements, like MWP, where elec-

tricity is not readily available. Keeping the costs of materials and facilities required for building to a minimum is crucial for redevelopment in the informal settlements because households can not afford to purchase very much more than the food and basic necessities for daily survival.

Although the Eco-beam system does not require any

electricity or many materials the Eco-beam structures are not of poor quality. Eco-beam structures are just as durable as traditional timber construction, yet the Eco-beam structures are more environmentally friendly and they are fire-resistant.

In order to bring housing to MWP on a large scale three key investments in a Eco-beam Factory, Sand Bag Sewing Factory, and Sand Bag Filling Operation are critical. These three investments are what the project team refers to as the key redevelopment industries. These three industries are discussed in detail in the next chapter.

ESTABLISHING AN ECO BEAM FACTORY

The establishment of an Eco Beam factory in Monwabisi Park will allow for the creation of jobs within the factory as well as the production for the EcoBeams used in the housing redevelopment. According the Mike Tremeer, four individuals are needed at one time to produce EcoBeams. One person will be needed to operate the

hand press and the three others will work to assemble the Eco-Beams. The labour for this factory can be sourced from within Monwabisi Park. At the minimum, the establishment of this factory can employ four individuals; however if different shifts are created and individuals work different days of the week, then more individuals can be employed. Because the construction of an EcoBeam has been optimized for simplicity, training sessions can take place in a couple of days by current Eco-Beam employees. Not only will this factory offers jobs for Monwabisi Park residents, but it will also give them experience in the carpentry field.

In addition to the creation of jobs, the EcoBeams produced at the EcoBeam Factory in MWP will be utilized solely for the construction of buildings and houses in the redevelopment. Producing Eco Beams within Monwabisi Park will lower the cost of housing redevelopment, as there will be no need to pay for outside labour in production of the beams.



Local Laborer in MWP

The details for establishing an EcoBeam factory can be found in Chapter 7: Eco-Economy Redevelopment.

ESTABLISHING A SAND BAG FACTORY

A sand bag factory located in Monwabisi Park could benefit the community in multiple ways. The first major benefit for the community will be the creation of jobs, as employees will be needed to sew sand bags for both a profit and use in the community. As housing



EcoBeams and sewn, filled sandbags utilized to construct the two-story Backpacker's Lodge in Monwabisi Park.

redevelopment begins, the sand bags will be a key material in the development, and having them produced within the community will reduce cost by of each sand bag by approximately 25%. In order to set up such an operation in Monwabisi Park, there needs to be a location for the sand bag factory and all associated materials as well as industrial sewing machines and trained management and workers. The details for establishing a sand bag factory in Monwabisi Park can be found in ^ Chapter 7: Eco-Economy Redevelopment.

A sand bag factory within Monwabisi Park can be established even before the redevelopment process begins. Mike Tremeer, owner of Eco-Beam, has agreed to purchase sewn sandbags for a profit of R0.20 per bag if a factory was to be established in Monwabisi Park. From this profit, workers can be hired and paid in the

Rand. Additional profit after the workers have been paid can be put a community redevelopment fund .

Once the redevelopment begins and the demand for sandbags for the buildings is present, sewn sandbags can be used in the Monwabisi Park redevelopment. Communal profit will be used to subsidize the purchase of these sandbags from the factory, thus lowering the redevelopment costs and continuing a salary for the sandbag factory workers.

SAND BAG FILLING

After sand bags are sewn, they need to be filled before they can be used for construction and insulation. The bags can be filled easily by almost anyone, and they do not require much physical labour. When constructing the Community Centre, the Indlovu Project had kids from the crèche fill bags

after school. A similar strategy can be applied to future redevelopment, as it provides free labour, and also allows more people to become involved in the redevelopment, creating a sense of ownership. Also, according to Dianne Womersley and Buyiswa Tonono, the kids enjoyed filling the bags, and it was a good way to keep them from doing making poor decisions with their free time.

SAND BAG SCENARIO ANALYSIS

The earnings, communal profit, and building material potential for one, four, and eight workers) working full-time in the factory is shown in Figures ^^^. These figures were based on the assumption that one sand bag can be sewn per minute, thus are rough, but fairly accurate estimates of productivity. By taking into account the inputs, the amount



Monwabisi Park Resident's filling sand bags to be used in the Back-

of sand bags sewn was related to the amount needed for housing redevelopment. Working full-time for one week, an individual can produce approximately 25% of the sandbags needed for the six-unit housing

structure. If the number of workers is increased to eight, then almost enough sandbags for two six-unit housing structures can be produced in one week. Using these sand bags in the EcoBeam houses in MWP encourages the notion of "earning your house" , as the labour hours put in results in a product needed for housing redevelopment.

The scenario analysis for sewing the sand bags can also be applied to sand bag filling.

By assuming that one sand-bag can be filled in one minute just like sewing a sand bag, Figures ^^^ can also be applied to the sand bag filling process, minus the profits, expenses and salaries.

Scenario Analysis for Sand Bag Factory

Scenario One (1 Worker)	
Workers/Machines	1
Days Per Week	5
Hours Per Day	8
Daily Salary	ZAR 70.00
Gross Profit	ZAR 500.00
Expenses	ZAR 24.25
Salaries Paid	ZAR 350.00
Communal Profit	ZAR 125.75
Sandbags Produced	2,500
Percentage of 6 Unit Housing Structure Completed	23.67%

Figure ^

Scenario Two (4 Workers)	
Workers/Machines	4
Days Per Week	5
Hours Per Day	8
Daily Salary	ZAR 70.00
Gross Profit	ZAR 2,000.00
Expenses	ZAR 80.00
Salaries Paid	ZAR 1,400.00
Communal Profit	ZAR 520.00
Sandbags Produced	10,000
Percentage of 6 Unit Housing Structure Completed	94.70%

Figure ^

Scenario Three (8 Workers)	
Workers/Machines	8
Days Per Week	5
Hours Per Day	8
Daily Salary	ZAR 70.00
Gross Profit	ZAR 4,000.00
Expenses	ZAR 160.00
Salaries Paid	ZAR 2,800.00
Communal Profit	ZAR 1,040.00
Sandbags Produced	20,000
Percentage of 6 Unit Housing Structure Completed	189.39%

Figure ^

How to Facilitate Local Skills Development

Local community workshops will be used to develop local labor skills related to the redevelopment effort. The workshops will be conducted by the local experts in various redevelopment disciplines, and will take place either in the designated workshop area or on a construction site, depending on the skill. Training people in skills related to the redevelopment will help advance the effort along with enable people to get jobs in the formal market.

MANAGER APPRENTICE PROGRAM

While there are many people possessing capable personalities for managerial positions in Monwabisi Park, they often lack the skills necessary for managing. Oftentimes this leads to the downfall of many well-intentioned enterprises that are started by outside organizations and then given the to the community to manage.

The WPI plan for redevelopment is different from traditional methods of redevelopment because it is a strongly rooted in the principles of self-help and community involvement. The WPI plan for redevelopment suggests that the community as a whole is capable of managing a comprehensive plan for redevelopment however, many people need some basic skills training in order to make them better pre-

pared to maintain successful sustainable enterprises. From fieldwork conducted in Monwabisi Park many business owners and community members are interested in developing business skills, management skills, among other skills to create and manage more successful businesses. Setting up an apprentice program at the start of redevelopment will aid in developing the necessary skills to make the people of Monwabisi Park successful in managing their local businesses and redevelopment.

The apprentice program would employ managers from outside the community to temporarily control the construction management, EcoBeam factory, and the sand bag factory. During this temporary employment, the outside managers will be shadowed by the member of the Monwabisi Park community who is selected to become the managers of the redevelopment industries.

During this apprenticeship program, factories will be in

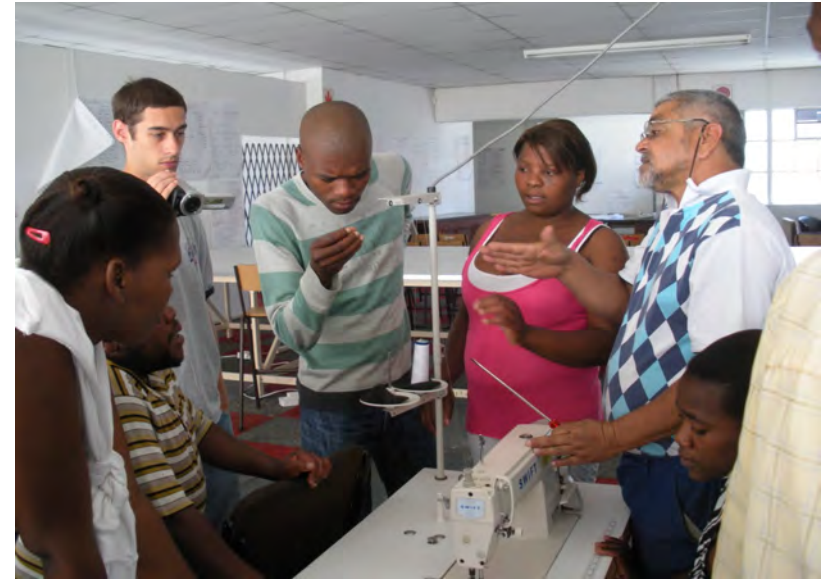

Sewing training workshop at Berzack's, Cape Town, South Africa

full operation. In addition to allowing production to start sooner, it will also allow the apprentices to see the issues that they will face during operation. The temporary managers will also offer other instruction on situations that may not arise during the apprenticeship program. The duration of the program will be determined by the temporary managers. When they feel that the Monwabisi Park managers have the ability to manage their factory by themselves the program will be complete. It is critical that the temporary managers make a concerted effort to not only get the operation successfully running from the start, but also to develop the Monwabisi Park managers with the necessary skills for operating the business over the long term. The tempo-

rary managers will need to be aware of the many issues of nepotism, greed, jealous, and other corruption that is commonly the downfall of many locally managed redevelopment efforts. However, if the Monwabisi park managers are well trained in how to deal with these issues from the start, there is a higher probability for successful management.

This skills transfer is so important to the success of any community-based redevelopment enterprise that the WPI project team feels that there should be funding set aside to compensate the temporary managers. Although the temporary managers may be volunteers, they will most likely be compensated by the Shaster Foundation.



Creating Local Exchange and Independence

One of the major issues with the economy of informal settlements is the unbalanced flow of the Rand. There is very little Rand coming into informal settlements because the low employment rates. Along with low inflow of Rand, most of the Rand being earned is spent back in the formal market on living necessities unavailable in the informal settlement. Creating a local exchange will make communities less reliant on the Rand and the formal market. It will also create a greater circulation of Rand in the informal market.

LOCAL ECONOMIC GROWTH THROUGH COMPLEMENTARY CURRENCIES

In order to create successful sustainable economic growth and job creation it is critical to have a structure for compensation of workers that is fair and cannot be corrupted. One of the major challenges faced by organizations working in informal settlements is financing the operating costs of new enterprises for redevelopment. In most cases once a business or community centre is established it requires skilled workers to keep the operation running successfully. However, in the informal settlements there is a scarcity of Rand and no one can afford to pay the workers who are needed to keep these operations running.

In order to solve this problem, communities need to look into alternative means to compensate workers. One way that the scarcity of Rand can be addressed is through the imple-

mentation of a complementary currency scheme. A complementary currency scheme is essentially an agreement within a community to use and accept a non-national currency as a means of payment. This kind of strategy is beneficial in an informal settlement because it allows people who have no means to participate in the formal economy to be active contributors to the local economy. One of the most significant benefits of complementary currencies that it allows the community to create new ways to pay workers that are sustainable.

The implementation of a complementary currency is an ideal strategy to be included in the WPI plan for redevelopment because it works closely with the principles of self-help, local economic growth, and community involvement. Implementing a complementary currency in a community that is dependent on the Rand is an immense challenge for any group of community leaders,

non-profit organization, or government-related initiative. However, this redevelopment initiative lends nicely to the creation of a complementary

currency system because of the number of new programs and enterprises that will be established for community benefit. Because these organizations are entirely new to the community there is no expectation of how things are to be structured or managed. This allows for the perfect experiment to see how a community embraces the idea of a complementary currency. This experiment is so valuable because it introduces the complementary currency in a new, natural way instead of forcing local businesses to accept a complementary currency or change in any other way. A brief overview of the new enter-

prises that will arise from the redevelopment initiative is outline in ^ Figure # : New Initiatives for Complementary Currency

The WPI project team has outlined a plan for implementing a complementary currency scheme in the MWP community. **The project team's plan** includes the creation of new jobs that will be critical to the successful implementation of a complementary currency strategy. The infrastructure and logistics for using a complementary currency scheme are written about in detail within ^Chapter 7: Eco-Economy Redevelopment.

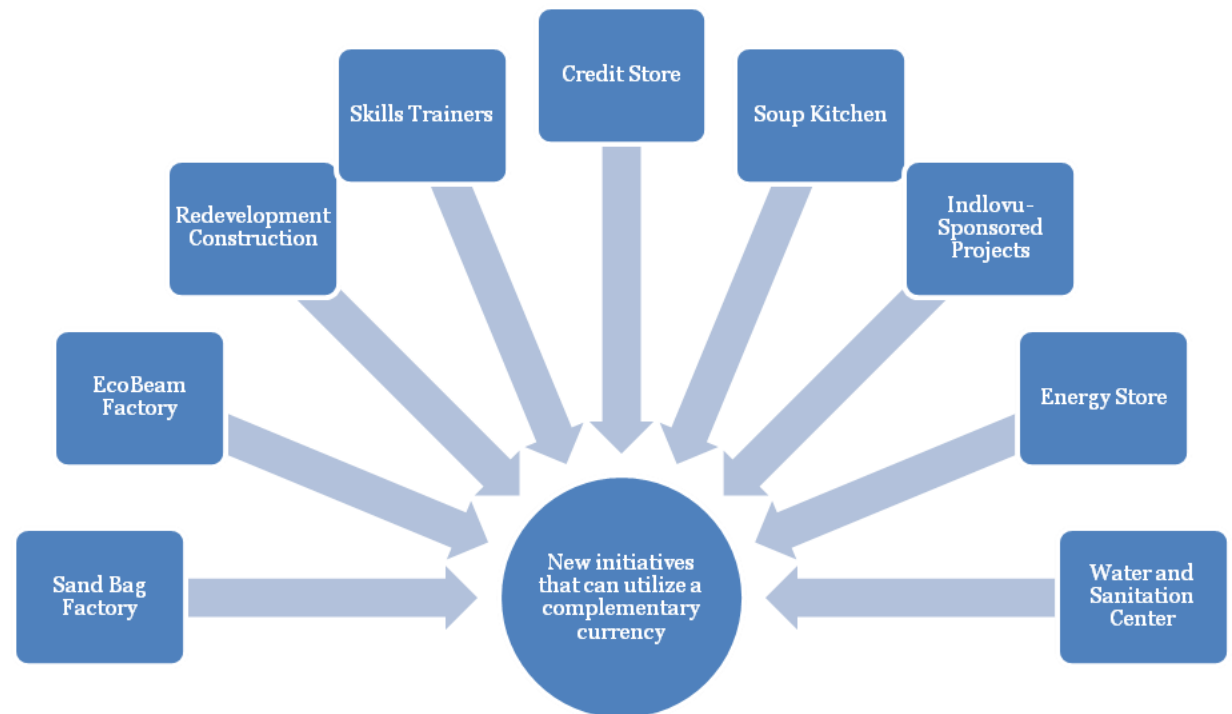

Figure #: New Initiatives for Complementary Currency

Managing Redevelopment with the Community

When it comes to managing community funds for redevelopment there is a strong emphasis to make sure that money does not get taken advantage of and that everyone in the community benefits equally from a community-wide investment. In order to account for concerns like these, among others, there needs to be a system for managing these funds in a fair and practical manner throughout the community.

CHARACTERISTICS OF DEALING WITH A COMMUNITY FUND

In order to effectively manage an investment for redevelopment within Monwabisi Park the WPI team proposes a simple, standardized structure for allocating these funds. When dealing with community funds in an informal settlement there are several special considerations that need to be accounted for to ensure that the finances are fairly distributed throughout the community. One of the goals of the project team is to transition as much control and responsibility for managing and allocating the investment into the hands of the community. This is the best practice because it allows for the community to feel a sense of ownership and pride in what they are accomplishing as more of the responsibility for redevelopment is in their hands. This method also allows for helpful money and management skills to be spread throughout the community. However, the biggest concern with this approach is that the money could be manipu-

lated and people could easily become corrupted and take advantage of community funds.

Another concern is that if an outside organization controls the funds in order to lessen the opportunity for corruption then the community will not have enough control over how the redevelopment actually happens. Taking into consideration these two primary concerns the economy team has planned a system for effectively managing community funds so that the community has control over how the funds are allocated, but there is still unbiased outside oversight to monitor for any corruption. It is crucial that the organization responsible for monitoring over the allocations made for redevelopment is as transparent as possible with their financial records and spending. This information needs to be made public and easily understandable to the community and all other interested parties.

TRANSPARENCY OF FUNDS

In order to further offset the possibility of corruption the

project team plans to have the Shaster Foundation, an unbiased outside organization that cannot be easily manipulated oversee the investment that is made for redevelopment. The Shaster Foundation will keep the money that is sourced from investors in a bank account **called the “community redevelopment fund.”** Shaster will be responsible for keeping the financial and spending records of the community redevelopment fund up to date and in good standing. Shaster will also make sure that this information

is made available to the public and so that it is easily understandable to someone who may not know anything about financial management. Creating this kind of transparency in the management of the community redevelopment fund is important to keeping the community informed about how the redevelopment is progressing forward. It is also an important way that the Shaster Foundation keeps a reputation within the community as a local non-profit organization devoted to the community rather than a

larger, powerful redevelopment bank with its own self-interested agenda.

THE MWP FORUM

Although the Shaster Foundation has overall control of the community redevelopment fund Shaster has a minimal role in making the final decision as to how the money is spent for redevelopment. Ultimately, the community will vote on how the funds are allocated for the redevelopment effort through the Monwabisi Park forum. The Monwabisi Park forum was the idea of Indlovu Project Manager, Buyiswa Tonono, and Shaster Project Director Dianne Womersley. The MWP forum will be created to include all of the special interest groups that exist within MWP so that decisions made on the behalf of the community will not overlook the perspective of any group within the community. This

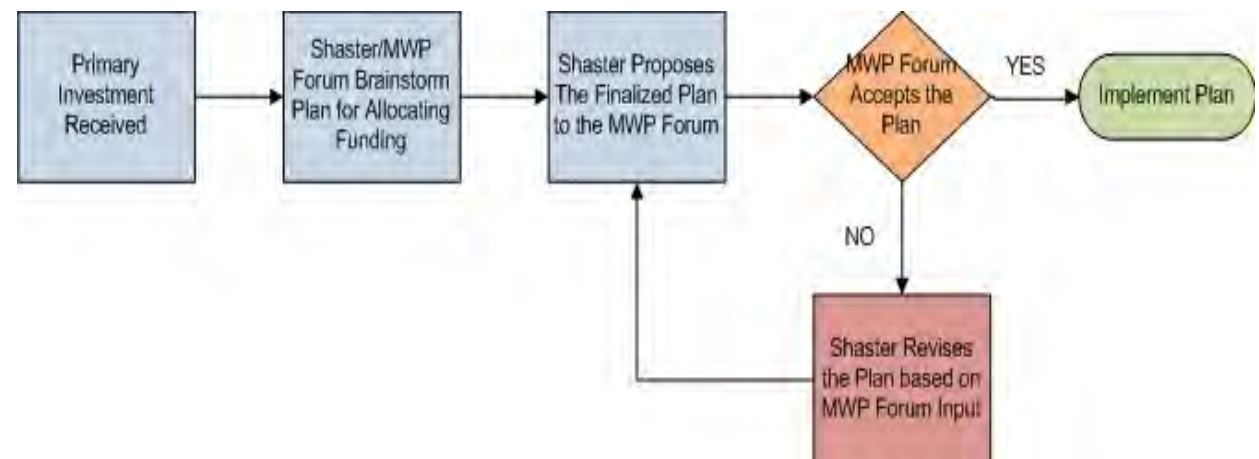

Figure 10: Shaster and MWP Forum Planning

forum consists of elected members from the following special interest groups: women, disabled, youth, health-care, business members, and the elders.

SHASTER AND MWP FORUM COLLABORATION

Although the MWP forum is the best group to ultimately decide on how the money is allocated for redevelopment it is unlikely that this group of skilled and unskilled community members will be able to plan and agree on an effective plan for allocating funding for sustainable community redevelopment. In order to help facilitate the meetings with the MWP forum the project team suggests that the Shaster Foundation is also **involved in the forum's meetings** in the beginning of the redevelopment effort. The project team suggests that the Shaster Foundation hosts a series of brainstorming meetings with the MWP forum to introduce the ideas of redevelopment and how money might be spent and allocated for redevelopment in the community. Then, using the information collected during these forums as well as the information collected from the WPI projects, the project team suggests that the Shaster Foundation proposes a plan for allocating the community redevelopment funds to the MWP forum. The MWP forum will then either accept the plan for allocating the funds or reject the

plan and make modifications as necessary until the plan is perfected. In this scenario the Shaster Foundation acts as a consultant to the MWP forum to help them make a smart, effective plan for sustainable redevelopment.

Mapping for Spatial Redevelopment



CHAPTER TWO CONTENTS:

- 53 INTRODUCTION
- 55 MOVEMENT AND ACCESS
- 57 PLACES OF CONGREGATION
- 59 SUGGESTIONS FOR FUTURE SPATIAL
REDEVELOPMENT
- 66 METHODOLOGY
- 72 REFERENCES

AUTHORS:

DEBRA FRANCK
WILLIAM MAYO
XIE YANXUAN
MATTHEW TOMASKO

SPONSOR:

VIOLENCE PREVENTION
THROUGH URBAN UP-
GRADING IN KHAYELIT-
SHA (VPUU)

An Introduction to Spatial Redevelopment

Monwabisi Park is located along the southern tip of Africa in south eastern Cape Town, South Africa, and is a neighborhood of Khayelitsha. Meaning “New Home,” Khayelitsha was established in 1984 during the apartheid era in order to accommodate the growing influx of black workers to Cape Town. When apartheid ended, there were no longer regulations on the movement of black people, and people poured into metropolitan areas from the Eastern Cape seeking new jobs. In many cases these workers only set up temporary houses on public spaces with the intention of either returning to the Eastern Cape or moving into more permanent housing once they had saved enough money. With so few jobs and such a large demand, these squatter camps quickly became both permanent and common place. Such was the case with Monwabisi Park.

As a result of this complete lack of formal planning, the vast majority of the land has been used for residences. Roads, gardens, community centers, and recreational facilities received little, if any consideration as people moved into the area. In turn, 66% of Monwabisi Park is currently inaccessible by emergency vehicles, while the entire park is home to only one community center.¹² Without any formal planning or major roads, the Park is currently a maze of pathways and houses, making it incredibly difficult to navigate throughout efficiently. The vast majority of the park is also unlit at night time, resulting in making it a haven for thievery, murder, rape, and other violent crimes. With so little concern for anything other than residences, the community also lacks the ability to produce enough food to sustain any significant portion of its residents.

This section will document the current factors that effect spatial redevelopment including lighting, violence, emergency access, movement patterns, and places of congregation. Through the examination of the strengths and weakness of the current practices, locations for three more community centers will be proposed, as will a more expansive travel network that will permit for the access of emergency vehicles while making pedestrian movement safer and easier.



THE GROWTH AND CURRENT STATUS OF MONWABISI PARK

In 1997 people began moving onto the Wolfgat Nature Reserve, where Monwabisi Park now stands. Since then, the population of the area expanded rapidly. By 1999 inhabitants occupied more than a 2 kilometer stretch of parkland. As the population grew it expanded away from the roads and towards the nature reserve's boundaries. Since 2003 the population of Monwabisi Park has remained fairly stable.

Major roads boarder the north, west and east sides of the park while the Wolfgat Na-



Images showing the population growth and evolution of Monwabisi^A

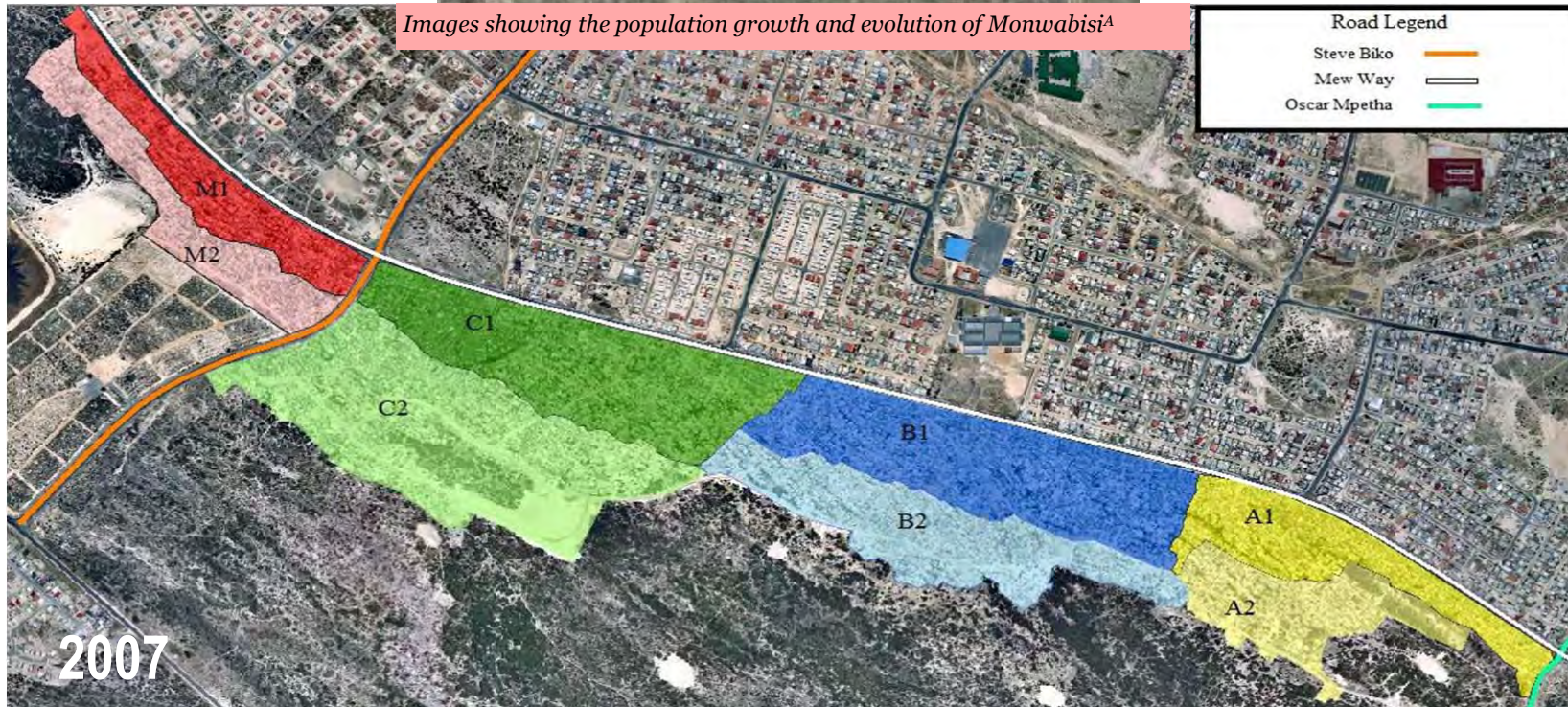

ture Reserve defines the remainder of the Park's outline. Similarly within Monwabisi there are several major dirt roads and foot paths which create somewhat of a divide in the clusters of housing. It is by these roads that the individuals in the community define the borders of the sections.

Within the sections, subsections M1, C1, B1, and A1 have direct access to electricity but have no toilet facilities. Subsections M2, C2, B2, and A2 have no direct access to electricity, but are provided with toilet facilities by the city.¹

Population Distribution By Age

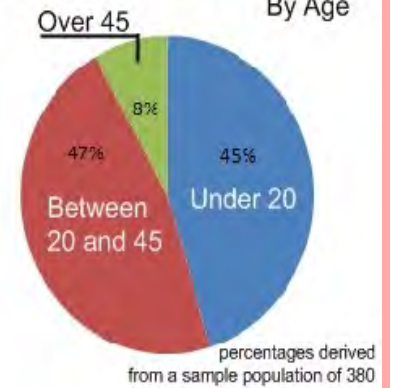

The needs of children are priority when further investigating and suggesting solutions for upgrading. Noting that the majority of people in the Park (92%) are either children or old enough to be parents supporting children, it is essential that education and childcare be high on the list of priorities when considering redevelopment and spatial upgrading.

Currently there are no schools within Monwabisi Park. All of the children in the area have to travel across the street to Harrare. This presents danger both in the distance traveled and the necessity to cross Mew Way where pedestrians are frequently hit by cars.

Movement and Access

Access to, and movement within any community is a major concern both in present conditions and future plans. The following section will address the current state of these issues in relation to violence, emergency access, and ease of navigation.

Walking is the primary mode of travel by residents of Monwabisi Park, as 96% utilize modes of transportation requiring walking to access them. In many cases there are no barriers between shacks (fences or bushes for example), and people travel in whatever direction seems the most direct to get to their destinations. While this **doesn't exclude walking on larger paths or roads**, it generally results in walking between shacks through pathways that are fairly narrow (in many cases less than a meter wide).

Modes of Transportation

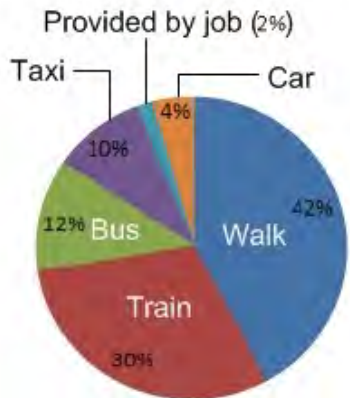

During the day this is a reasonably safe practice, and people enjoy the sense of community this creates through frequent interaction. When the sun goes down however this method of travel becomes infir-



Small footpaths are prevalent throughout Monwabisi Park, and the one shown above is bordered by bushes, becoming a potentially dangerous area after nightfall.

nitely more precarious. These narrow pathways are largely in shadows make it difficult to

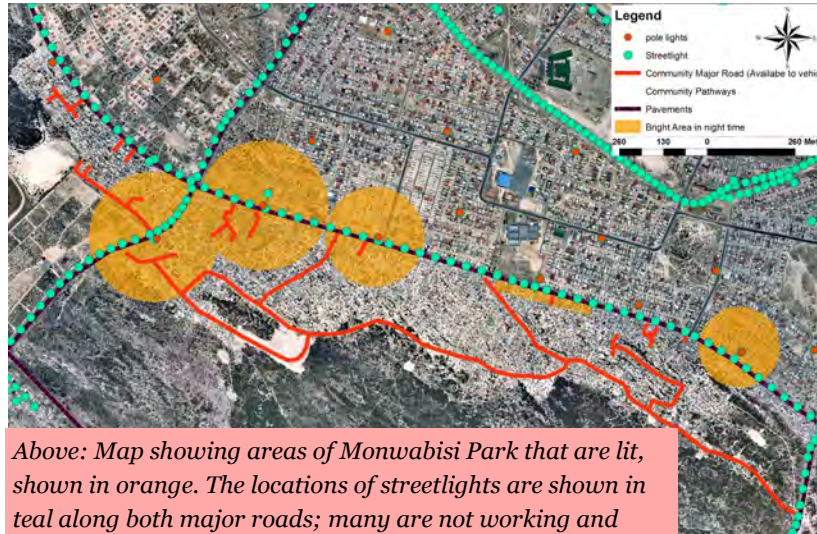

Above: Map showing areas of Monwabisi Park that are lit, shown in orange. The locations of streetlights are shown in teal along both major roads; many are not working and thus provide insufficient lighting.^{10,D}

know what, or who is near by. Wider pathways would seem to rectify these problems, but in reality the wider roads are just as dangerous despite the open space and visibility they provide.

Nearly all of these roads are poorly lit therefore diminishing the benefit of the wider path.

SPECIFIC DANGER AREAS

At night, other dangers are more prevalent throughout the community; crimes ranging from muggings to murders occur when the sun goes down in Monwabisi Park. The lack of lighting combined with the uneven terrain of Monwabisi Park creates an optimal setting for criminal activity. The bushes that form the southern border of the area are hotspots for crime as they provide hiding

places and are shielded from most of the **community's view. In addition** to the general outskirts of Monwabisi Park, there are a few high-danger areas, namely the cemetery and the ravine. Located on the southern part of M section, the cemetery, high-

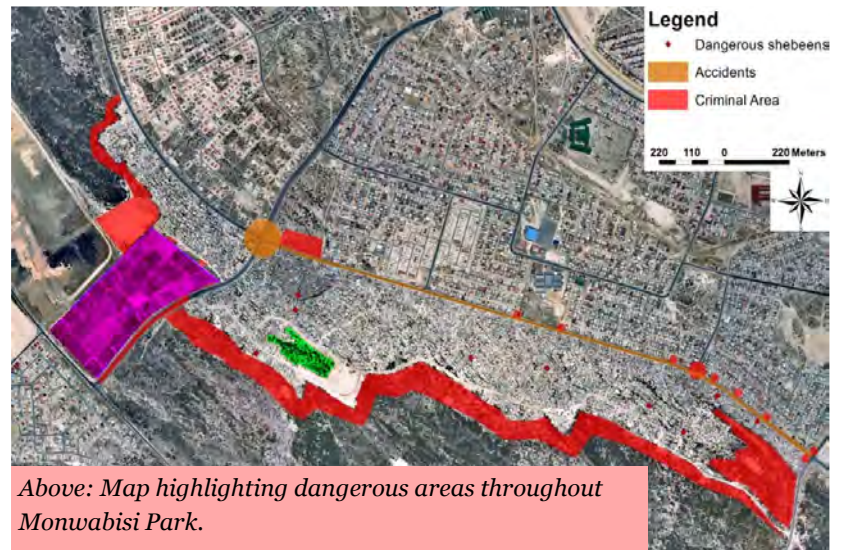

Above: Map highlighting dangerous areas throughout Monwabisi Park.

lighted in purple, is a haven for drug users. At night, drug dealers and users congregate in this area, and most people avoid travel near it. Tick, or Crystal Meth, is the most common drug used in Monwabisi Park. The Ravine located in C2 (shown in green) is another dangerous area. The steep slope alone poses threats in the dark, but it offers a more sinister function as it has become the dump site for bodies in the Park. Aside from these specific geographical areas in Monwabisi, shebeens also pose a safety threat to community members. People tend to avoid certain shebeens as gangs congregate in specific areas, leading to increased crime rates, especially occurrences of muggings. When it is dark, the community avoids traveling in these areas

because the small paths and dark corners create easy targets out of people passing by.^{2,3}

TRAFFIC AND SAFETY

During the day, Mew Way is a dangerous area due to the dense traffic flow and lack of speed restrictions combined with the large amount of people that travel down and across this major route. Cars drive down this populated straight road at high speeds because there are no speed bumps, or other speed controllers, to slow the traffic, leading to accidents along the road. During Charrette 2, it was found that 7 car accidents have recently occurred just along Mew Way.⁶



People walking along Mew Way

EMERGENCY ACCESS

Since most people in Monwabisi Park do not own cars, there has been few provisions made for them within the park. Thus, roads and larger pathways are infrequent compared to the smaller paths.

In addition to violence con-

cerns already addressed by this infrastructure, the lack of car access presents another set of issues. Emergency vehicles cannot easily access the vast majority of Monwabisi Park. This means that it is difficult to put out shack fires or get someone out of the park if they cannot walk. Fire truck hoses come in 30 meter lengths and can be connected for up to a 90 meter hose length, however most of the trucks that respond to the area only carry one hose. In addition to a small minimum radius of effectiveness for these trucks, stand pipes are infrequent, difficult to find, and often do not work well. Further worsening this situation is that the taps within the park do not

Fire Truck Access

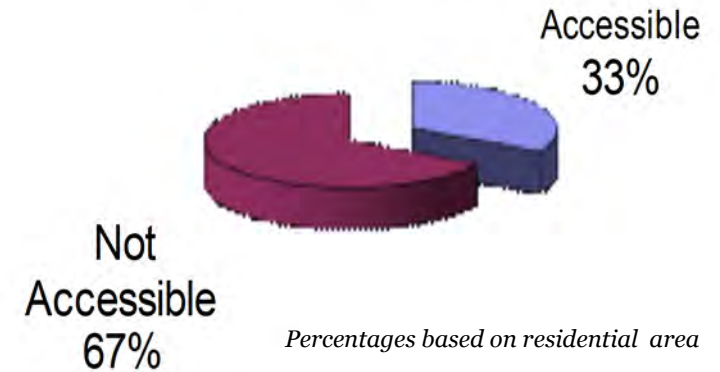

provide enough pressure for use by fire trucks. This means that fire trucks are generally further limited to the amount of onboard water they can carry.

Only compounding the limitations of fire trucks is the rate at which fires in this area spread. Currently shacks are placed right beside each other so as one shack burns it immediately puts every other shack around it at risk. The Mitchell's Plain fire department routinely has trouble responding to the fires in the area because their emergency vehicles are too large to fit down the narrow dirt pathways. Even if the pathway is large enough to fit the trucks, rounding tight corners and weaving between shacks is still time consuming and can delay the emergency response significantly. Even once fire trucks reach the point on the road closest to the fire, it often requires a hose to be snaked between shacks, which is time consuming, lowers the amount of space they can cover, and can damage hoses to the point of being unusable if they get caught on something sharp.¹⁰



Above: Map showing the buffer area that emergency vehicles can currently access. A fire truck can reach a maximum buffer area of 30 m from a stationary position on a road.¹²

Places of Congregation in and around Monwabisi Park

Having areas designated for uses other than work and housing are necessary to a healthy society. This section contains documentation of the current places of congregation within Monwabisi Park, as well as those in the surrounding areas which draw residents from Monwabisi Park.

THE COMMUNITY CENTRE

The community centre in C section was a major aspect of the community. Called the Indlovu Centre, it was comprised of a crèche, clinic, soup kitchen, youth centre, backpackers lodge, and guest house. Community members, especially the residents of C section, would congregate in the Indlovu Centre, socializing while utilizing the offered facilities. The centre provided a social environment while greatly aiding the community, especially though the clinic, soup kitchen, youth centre, and

crèche, proving to be a vital part of Monwabisi Park.^{1,2}



Above: Outside of the Indlovu Crèche sponsored by the Shaster Foundation.



Above: Crèches and Churches in C Section

CHURCHES AND CRECHES

The map in the bottom left corner shows the locations of crèches and churches within C Section. Crèches are an important part of the community as they provide day care and early education for the children of Monwabisi Park. The crèche associated with the Indlovu Centre is a Montessori School, and alternative educational style that is focused on children



Above: Zion Apostolic Church

directed learning. There are 3 churches within C Section⁵, and each are of different denominations. Religious centres are important aspects of the community, as they serve multiple functions; the Zion Apostolic

Church serves as a kitchen for people unable to feed themselves. The 4 crèches and 3 churches of C section do not **meet the community's needs**, as they cannot service the entire population of C section, nor any community members travelling from other sections.^{1,2}

SHEBEENS

Shebeens are a major part of the community of Monwabisi Park. In C Section, there are 30 shebeens, shown in purple on the map, than any other type of business in this section, and most are open during the day and at night. Shebeens serve many purposes besides selling alcohol; they provide a social environment for people to interact with one another. They are also a place to post information and to have meetings. It is relatively easy to open a shebeen, and many sell beer they have brewed themselves, but

Below: Men enjoying a game of pool in one of the local Shebeens.

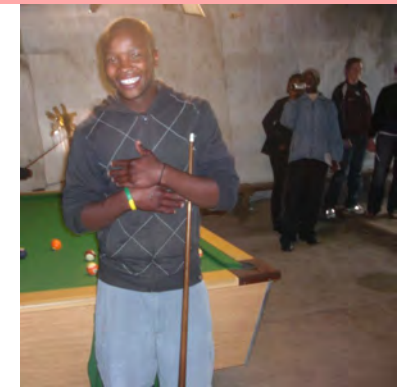

because of the large amount already present in Monwabisi Park, shebeens tend to have a short business life. Shebeens can also be dangerous, especially because most people attending them are inebriated, but also depending on their spatial orientation, location relative to lit areas, and types of people that attend⁶.



Above: Shebeens within C Section

TRAVELING TO HARARE

Monwabisi Park is almost entirely dependent on areas outside of the Park for social and economic needs with the exception of housing, taverns, and churches. This means that many residents leave the park for recreation, work, education, and gatherings. Since this dynamic has been present since people started moving into the area, the network of paths has developed around the need to get to these outside locations. For work, this means traveling to either bus stops on Mew Way, or to the train station in



Above: Map showing the major travel paths used by people to travel through Monwabisi Park.



Above: The informal businesses and formal structures in Harare offer many services the people of Monwabisi Park travel there to use.

Harare. For recreation residents head for the soccer field in Harare, or Monwabisi Beach to the south east. If residents want something more than what the local spaza shops keep in stock, it means they are yet again traveling to Harare.

Looking to the map above, the major pathways for the most part lead to these locations. With a lack of facilities in Monwabisi Park, there has not

been nearly as large of a demand for major pathways or roads enabling travel parallel to Mew Way, and as such the pathways leading in these di-

rections are far less well defined.

The Image to the left shows two major areas which many community members walk to everyday from Monwabisi. The shopping center circled in green is a place which many have to travel to when groceries and other products used in daily life. The school circled in red is a place which many children have to walk to twice back and forth daily. They walk in once in the morning for class and then walk up to 40 minutes to their homes in Monwabisi for a lunch meal and then back to school after to finish the days classes. This walk is also very dangerous as well as time consuming especially for those children who have to make this trip alone and 4 times a day.^{2,6}



Above: Map showing the school and shopping centre in Harare that people from Monwabisi Park travel to.

THE LANDFILL

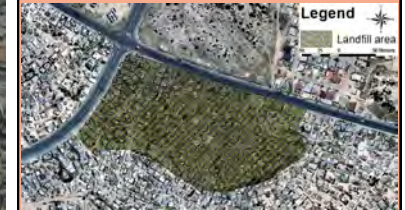

C section, the oldest part of Monwabisi Park, is built on a 35,000 square meter area of landfill. Living on a landfill raises two serious problems for the people in Monwabisi Park: contamination and drainage. Firstly, the landfill has contaminated the groundwater because of disintegrating trash mixing with the water naturally found in the ground. The community cannot utilize the groundwater, something that would help alleviate the already short supply of water in Monwabisi Park. Second issue is that the landfill makes this area less permeable to rain water. This is a major problem during the rainy winters of South Africa, as the entire area, and particularly **people's homes become flooding zones**. After the heavy rains, standing water still remains on site, **as it doesn't soak into the ground**, leading to many public health and sanitation issues.^{6,12}

Suggestions for Future Spatial Redevelopment

When planning for the spatial redevelopment of Monwabisi Park, it is vital to take into account that the amount of vacant land within the accepted boundaries of the park is extremely limited. With this in mind, it makes any sort of large scale relocation unfeasible without it being exceedingly detrimental to the community.

Any large scale upgrading plans will take a significant amount of time to implement. Rather than focusing immediately on housing, as previous efforts have done, it is more beneficial to strengthen the community first. A stronger, more unified, and more informed community is much easier to work with since plans require significant community support. Under this pretence, the following section will present concepts for successful spatial redevelopment in Monwabisi Park.

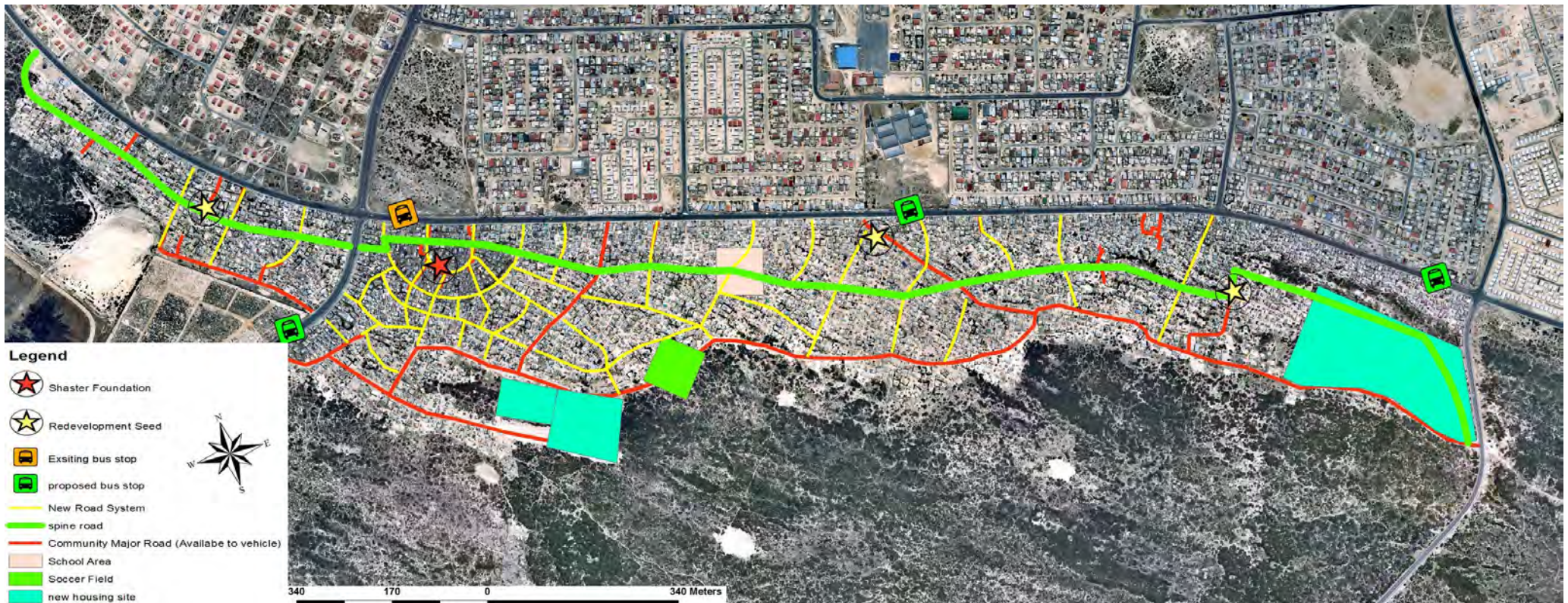

Above: Map showing the possible macro spatial redevelopment plans for Monwabisi Park. Included in this proposal are formalized roads, community centres, bus stops, and potential locations for a school, recreational fields, and new housing sites that will be discussed in the section. ¹²

COMMUNITY CENTRE CONSIDERATIONS: REDVELOPMENT SEEDS

There is currently only one community centre within Monwabisi Park, and it cannot service the entire community. Due to this deficiency, the community would benefit tremendously from the creation of more community centres. By placing a community centre, as part of redevelopment seeds, in each section the needs of the community would be better met, and it would be easier to gain support of community leadership to do so.

When determining potential locations for future redevelopment



Sign at the entrance to the Indlovu Centre, the only community centre that previously existed in Monwabisi Park. Located in C Section, the Indlovu Centre was sponsored by the Shaster Foundation.

Important Considerations For New Locations of Community Centres

- 1)Location within section
- 2)Proximity to existing roads
- 3)Amount of displacement required
- 4)Location with respect to known problem areas

ment seeds it is important to consider the following factors:

Presuming that each section is getting a community centre, it is important to keep each centre centrally located within each section because the community views this as the fairest

location as it provides equal distance for access. Due to a fairly consistent housing density within each section, this assumption is reasonably accurate. It is also important to keep community centres centrally located in order to keep the centre secure, and to make the community safer. Most of the crime in Monwabisi Park is that of opportunity committed by people from other sections or areas. Thus if the park is within the community it is easier for members to take ownership of it. The increased traffic to the centre within the section also means that there are more

people there to prevent crimes of opportunity.

Proximity to existing roads is also an important factor in determining location. In order for new redevelopment seeds, and in them community centres, be built, it will be necessary to bring in large amounts of supplies. Roads also provide access to the centres, as many types of traffic need to be able to reach each section: emer-

Right: the proposed redevelopment seed for C Section. It includes a Wendy house, crèche, clinic, guest house, communal water facility, and housing units.

gency vehicles, as well as commercial and residential traffic. Thus, situating community centres along existing roads allows for the necessary access without the additional cost and difficulty of making new roads and displacing additional people.

Any open spaces that currently exist should also be noted, as they would be able to accommodate a new centre with the least amount of shacks displaced. If these centres are isolated efforts (in that there no immediate plans for new housing), then relocation becomes a major issue. Community members are generally extremely reluctant to move their shacks unless doing so presents a di-

rect benefit such as new housing or improved utilities.

The final consideration is creating a safe space around each centre; utilizing an open area with the least amount of dark corners, far from the brush, and with accessibility to electricity for lights is essential. A location in each section that is along a major existing road, in a relatively central area, and away from dangerous areas, would be the best possible site for the future redevelopment seeds.^{E.F.G}

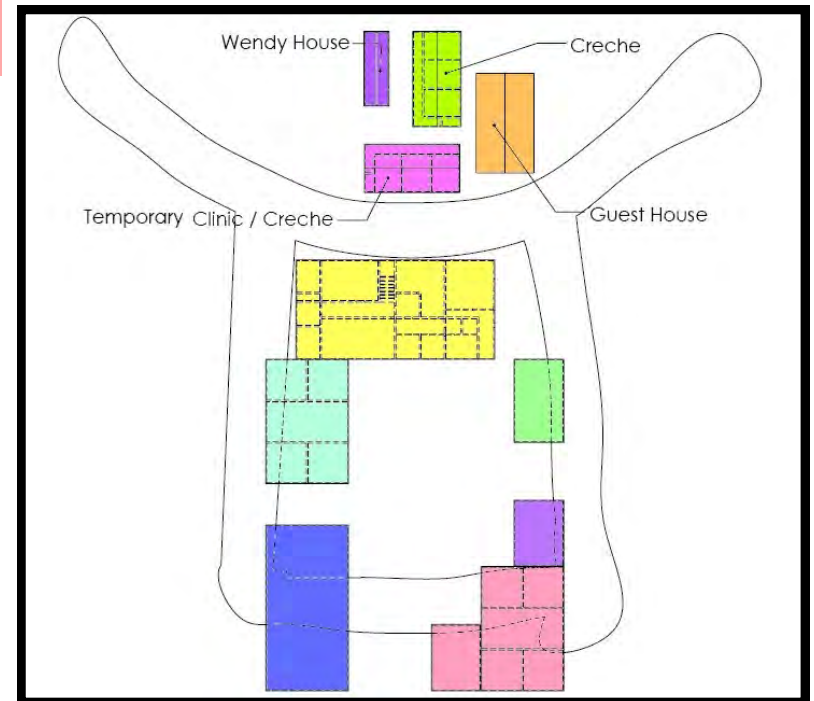

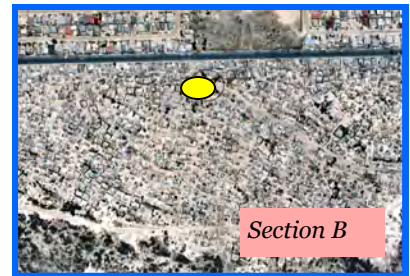
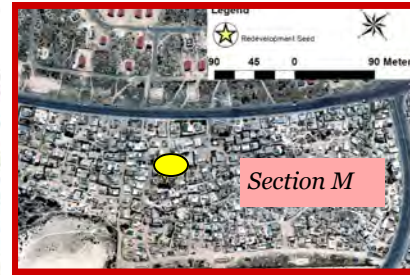

Above: Potential Locations for Redevelopment Seeds in M, C, B, and A Section of Monwabisi Park

SUGGESTIONS FOR SPECIFIC LOCATIONS OF REDEVELOPMENT SEEDS

As the Indlovu Centre is currently established within C Section, there is no reason to rebuild in a new location. Each of the other sections however have their own set of concerns when planning for a new community centre.

For M Section, there are a few major factors to consider. The bushes, dump site, and graveyard along the back of this section all present serious dangers, so the centre should be closer to the road than the back. In terms of existing

roads, there aren't any that provide access across M Section. There are few short paths wide enough for cars along Mew Way however, so to diminish the amount of houses required the centre should be located along one of these paths.

Section B Shares similar issues to the previous two in terms of the danger presented by the bushes at the rear of the park. What sets section B apart from the other sections is that there is a school directly across the street in Harare. By placing the community centre close to the school, it would mean that kids would have to travel less distance after school, and create a safer atmosphere around

the school. Placing a centre here would provide more justification for speed bumps of some sort across from the school where there are currently a significant number of accidents.

Section A is slightly easier to determine a space for a community centre. There is a road which stems off from the back road of Monwabisi Park and divides the section in two. The area along this road is less densely populated, and has room for a centre without displacing a large number of shacks. Key safety issues are the bushes around the back and eastern sides of this section, however

by placing this centre centrally there is a sufficient buffer between the two.^{E,F,G}

ROAD DESIGN CONSIDERATIONS

When developing a plan for a new system of roads in Monwabisi Park it is important to consider the existing roads and pathways as potential sites for development. Though these routes do not follow any particular grid system, they do provide a starting place for a network of travel within the park. Using the existing roads displaces the least amount of residents during the construction process and maintains the

Below: Image of the major road that follows the back border of Monwabisi Park. It is made of sand and loose gravel, which does not preserve its shape in the wind.



community's sense of structure, thus ensuring that the residents feel like their surroundings are familiar.

In order to lower construction costs, it would be ideal to make all the roads straight and parallel, with perpendicular intersections. Other benefits of a straight road are that they make the installation of electric and water lines much easier and they increase the distance an individual can see at street level. However, simply laying down a new grid system without respects to the existing map would negate these benefits; therefore it is imperative to take into consideration the ideas and experience of the city while maintaining the existing principles that the community identifies with. Realistically, the principle of straight roads can be applied at a smaller level such that each curved road is really a series of straight roads.

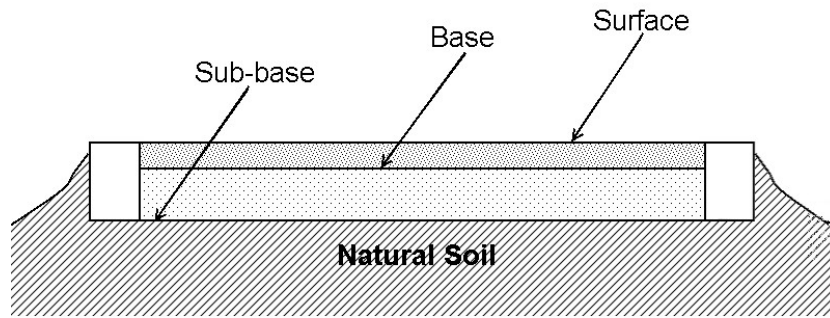

Above: Layers of the Proposed Laterite Road System. The road consists of a sub base, surface and concrete sides.

Emergency vehicle access is also very important to consider when designing the road network. According to a representative of the City, a 4.5m wide road is enough space for a fire truck to navigate comfortably. It is not only important that the vehicles can fit down the roads and maneuver around corners, but also that the trucks can service all areas of the park. Therefore the road density must be such that there are

places within the park that are more than 30m away from a road in any direction, because the length one fire hose can reach is 30 meters.

Utilizing a combination of straight roads and curved roads, all a width of 4.5 m, with each road covering a 30 m land buffer, the suggested road system is expected to serve all the functions of the existing pathways while increasing the safety and ease of transport on many

different levels. It is also intended that this plan represents an adequate balance between costs and improving the standard of living in the Monwabisi area.

PROPOSED CENTRAL ROAD CONSIDERATIONS

Residents generally only have three options when they want to travel to another section of the park: Mew Way, the perimeter road on the back of the park, or weave through the pathways and around shacks in the middle of the park. None of these options provide an easy travel choice for community members, and the majority of people in the park end up taking a route that is much longer than necessary; in doing so are wasting time and putting themselves at an unnecessary risk.

In addition to this there is a safety concern with the existing methods of travel. Mew Way offers a direct path but it is on a busy, dangerous road where motor vehicle accidents are common because of the vehicles can travel at high speeds. The perimeter road is less direct than Mew Way, with a lot

Proposed Road Quick Facts

- 4 1/2 meters wide
- Compacted laterite surface
- 30 meter fire buffer
- Follow existing roads as much as possible

less traffic but it is near the bushes at the southern end of the park, in an area generally considered unsafe by the community because of the potential for muggings. Finally, the method of travel between shacks is very random and provides no safety from the dark corners and brush throughout the park. A central road parallel to Mew Way, which bisects the Park, will open access to new areas and shorten travel routes within the park while decreasing all of the aforementioned risks of the current travel methods.^{11,C}



Above: Proposed New Road System for Monwabisi Park

Among the most immediate benefits of the central road is that it can improve safety within Monwabisi Park. The new road will provide more visibility than small footpaths, keep travelers away from the dangerous bushes, and follow existing paths so that vehicles **can't travel at high speeds** as they do on Mew Way. The road will also provide opportunities to build more business and community facilities. These facilities, in turn, will increase the foot traffic along this road, stimulating the business growth and aiding the economy. The central road could be seen as a catalyst for economic and social development in Monwabisi Park. Furthermore, the road will serve as the central line for the rest of the **park's infrastructure; with respect to the existing pathways, other roads will be built to connect the central road to Mew Way and the perimeter road at the back of the park**

IMPLEMENTING THE CENTRAL ROAD

Regardless of the fact that the central road will closely follow the existing pathways, the construction of the road will take a long time and will displace many residents. Since **this road doesn't offer immediate benefits** to the current state of education, child care, electricity and water, it is uncertain whether or not the community



Above: Proposed New Road System with Highlighted Central Road for Monwabisi Park

members will be in full support of its construction. However, this road does offer improvements in safety, ease of travel and local economy, therefore has the potential to vastly improve the lives of residents in Monwabisi Park.¹¹

“LOOP” DESIGN IN C SECTION STUDY AREA

The shacks centered on the area between the Indlovu Center and Mew Way follow a semicircular pattern. Besides the many footpaths in the area, there are two major roads (shown in the map) that serve as main entrances for vehicles and pedestrians alike. These existing main access roads are

Right: District Area in C Section, showing the two major existing roads in this area.

both at least 4m wide, and their entrances are 75m apart. Currently they do not connect and provide minimal vehicle access

to the immediate area.

The proposed design will initially connect and realign these two roads to create the

“loop.” This will improve the current state of these roads by widening them to 4.5m and providing a route for traffic to travel through the area rather than the existing dead ends. The roads also provide proper emergency access to the entire area given that a fire truck can service any area within 30m of the road which it is on. Being able to access 100% of this area is a vast improvement over what exists now; the two current dead end roads only service 30% of the area.^{10,12}

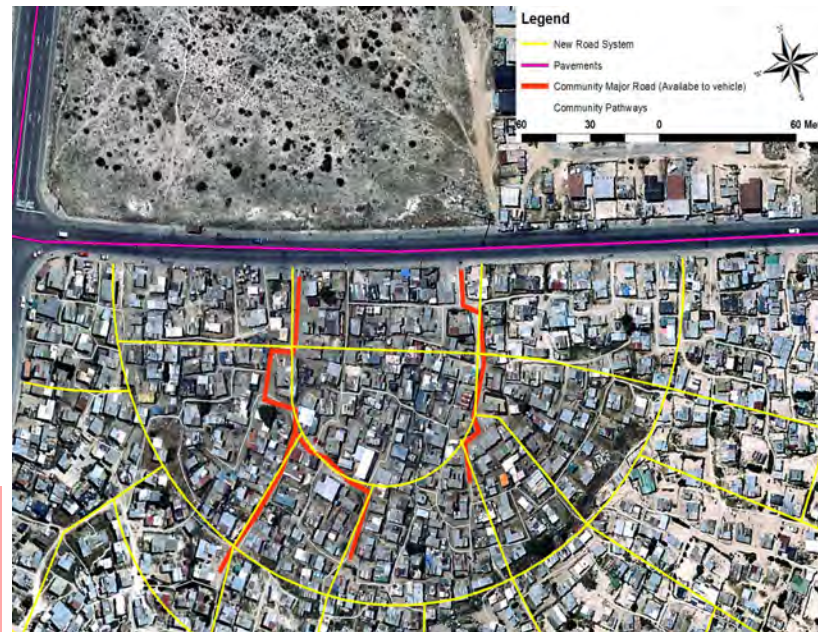

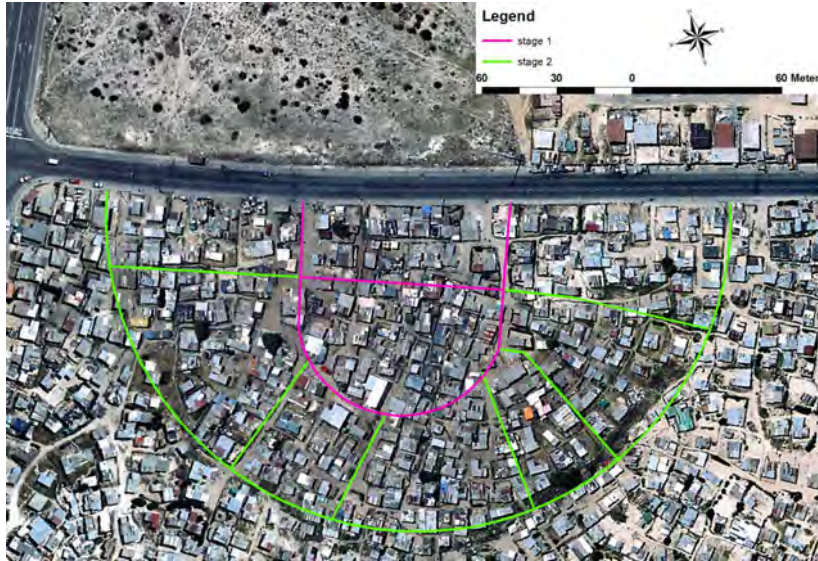

Left: The Loop Road Design for the District. The inner loop will be implemented in stage one of construction, followed by the larger outer loop.

were more willing to relocate given the following concerns:

- 1) Improved Housing
- 2) Proximity to their current shack
- 3) Improved utilities
- 4) Single Move
- 5) Safety of New Area

If residents were to be relocated, they want to stay relatively close to where they currently are. Residents were also unwilling to move to an area without electricity. To this extent community members also unwilling to move away from water sources.

If these concerns were met, residents were willing to move for improved housing as long as it was relatively close in order to preserve their community. The new area would also have



Left: View of C Section showing the high density of shacks compared to open space. In order to relocate families with the least ramifications an approach to redevelopment that allows for a large area of shacks be relocated as opposed to one that follows a small scale redevelopment strategy.

to be safe. For example, residents were unwilling to move from a well lit section to an area bordered by bushes. Most importantly however was the idea that if they were to move, residents did not want to have to move a second time.

SINGLE MOVE RELOCATION

Single move relocation requires a few things in order to succeed, namely open space and efficient housing designs. New housing could be constructed in an open space in a manner which could fit into a large scale organizational plan, and while using less space than the shacks they are replacing. As this method progresses, it has the potential to free up significantly more space than the initial open area.

With this in mind, Monwabisi Park has very little room to expand, as it is currently on a nature reserve. There are however two areas enclosed by the back border of the park which could serve as relocation sites. These sites are roughly the size of redevelopment seed. If elec-

tricity and lighting were to be brought to the back of the park (a major community concern regardless of relocation), then people could be shifted back into new housing, which would create more space than the original open areas had to offer. In this way new houses could be built over time without any major relocations, and in doing so would create excess free land for more space consuming community facilities such as schools, soccer fields, industrial sites and more community centers.

SOCCER FIELDS, SCHOOLS, AND LARGE SCALE COMMUNITY FACILITIES

As there is extremely limited open space in Monwabisi Park, there are few options for building facilities which take up large amounts of space. While these areas could be used for this purpose should a reason arise, it would be much more beneficial to the community to utilize the single move relocation outlined previously.

There are several advantages to this approach. Like the community centers, placing communal facilities in areas surrounded by residences, rather than along the back of the park enables the community to take ownership of them. This means that the facilities would be surrounded by people who

In order to construct these roads, the space needed will first be cleared by moving existing shacks near both intersections of Mew Way. These particular shacks will be moved into the space of the existing path so that the new road will utilize the space the shacks used to occupy, thus making **the road's path more direct.**

Other shacks, particularly those where there currently is no road of any kind, will have to be moved in this manner or even removed and replaced by more space efficient housing. These roads will encourage more pedestrian and vehicular traffic in the area which will benefit the local economy. In addition to this, the roads will provide better access to the **Shaster Foundation's Indlovu Centre** which will be extremely

beneficial to the social network of Monwabisi Park.

RELOCATION PRINCIPLES

Relocation of people in informal settlements has in, in large part, ended with failure. In many instances it is hard to get people to leave their temporary housing once construction **is complete, people don't want to move in the first place, or people just leave entirely once construction starts.** When construction is over, the community is entirely different than before, and in many cases the change is not positive.

With such a high density of houses within Monwabisi, it is unrealistic to presume that new housing can be built entirely without relocation. With this in mind, community members

care about their maintenance, as well as the safety of those using them.

If such an instance arose where there was funding for such a project, a school is a major desire within the community. The closest school is in Harare, meaning that children have to travel long distances to receive an education. Recreation areas are also a desire, as there is currently no space for this use.

Possible locations of both a school and a soccer field are shown in the map below. The school is centrally located to provide equal access for everyone in the park. The soccer field is also located, but is located along the back of the park as a possibility for immediate implementation should that become a possibility.⁶

BUS STOP CONSIDERATION

Currently there are three modes of public transport; one can walk over 1.5 km to Khayelitsha Station, take a taxi which is considered too expensive or they could take the bus. Currently there is one bus stop in the Monwabisi area, and it is located across the street from the entrance to the Indlovu Centre. Incorporating more bus stops has the potential to reduce pedestrian travel along Mew Way and, in turn, improve safety.

In Cape Town the buses are run by Golden Arrow Bus Service and the current system includes stops no more than 750m apart. Proposing the addition of 3 more bus stops, one along Steve Biko Road and

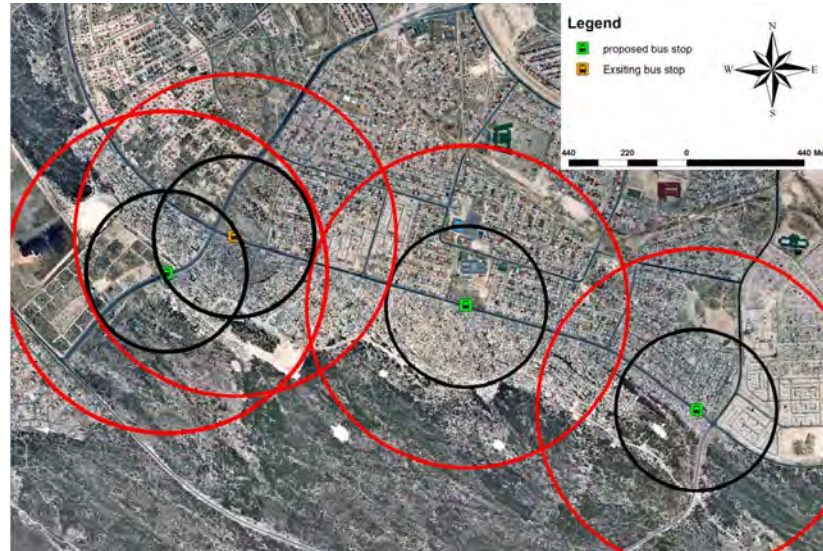

Left: In black shows a five minute walking distance from proposed and current bus stations while the red shows a ten minute walking distance.

two More along Mew Way, would similarly service this area with a slightly larger space in between (approximately 900m). Because this area is not as busy as the center of Cape

Town, the added distance is considered an optimum distribution of bus stops. At an interval of 900m most residents could walk to the stops in about 10 minutes.

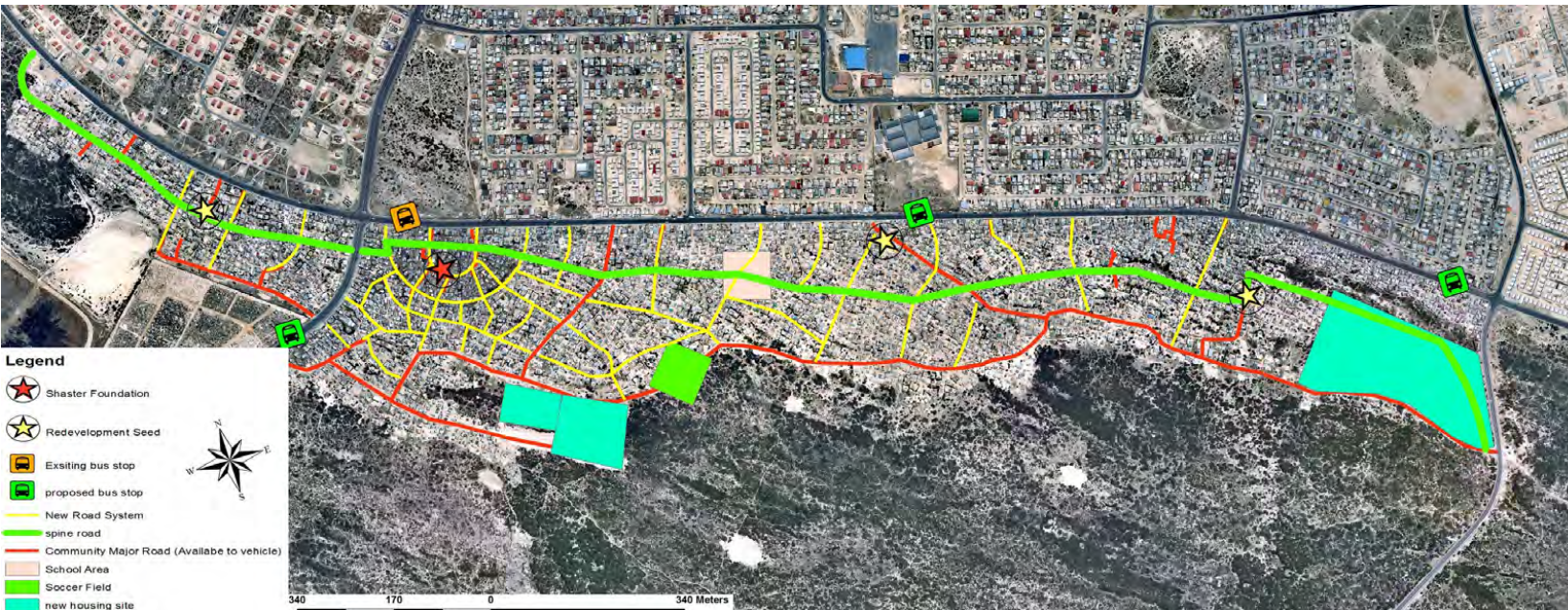

Below: The areas highlighted in teal are potential residential relocation areas that would be ideal for single move relocation.

Methodology

1. Community Mapping Exercise One

Community Mapping in this context is intended to help researchers and residents alike understand the existing conditions in the community to the fullest extent possible. The use of maps and other visual aides is a great way to facilitate discussion especially when confronted with a language barrier.

Due to limited recourses we utilized images of Monwabisi Park from Google Earth, and printed it out on several sheets of paper. We then cut and taped these sheets to make one continuous map. While the resolution was less than what was desired (it was difficult to pick out specific houses, however major roads and clusters were clearly identifiable), we hoped to gather some baseline data, and **get an idea of the Park's structure.** We started by spreading the map out on a table without saying anything, and let the co-researchers look at it and talk for a little while. After they seemed to have oriented themselves, they started speaking to us in English, and pointing out things on the map; stores, taverns, toilets, and other things near their homes. As inadequate as the map may have been it was the first time the co-



Community Mapping Exercise : Locating Shebeens in C Section with Co-Researchers.

researchers had seen a map of their community, and there was a general excitement throughout the process.

During this exercise we collected a variety of data with relative ease. We handed out pens, and let the co-researchers mark down what they could on the map. We left that day presuming that if we returned with a more accurate map, the co-researchers would be able to distinguish the locations of the things we needed to whatever accuracy the map we could procure would allow. In

the next mapping exercise we would find out that this was not entirely true

2. Community Mapping Exercise Two

For the second community mapping exercise, we returned with maps from the city planner's office, and the intention of gathering as much information as we could. We started by trying to locate the crèches and churches throughout the park. In order to do this we had the co-

researchers circle them on laminated maps with dry erase markers. What we soon discovered however was that the co-researchers (all of whom were from C Section) knew very little of the other areas. They were eager to help though, and it was difficult to change the course of discussion before they felt they had done the best job they could.

We left this exercise a little **discouraged, as we hadn't expected** to run into any problems. When we compared the data for C Section to the walks we had taken around the area, and when we showed the other co-researchers, we discovered that within their own section the co-researchers could identify a business, crèche, or important feature as well as the map quality would allow. This was extremely reassuring, and made us realize that if we wanted accurate data for the rest of the Park we would need to find members from other sections.

3. Charrette #1

In the discussion of spatial redevelopment plans for Monwabisi Park, 3 groups comprised of student research teams and locals alike were asked to consider how and why certain areas need to be upgraded. The groups

were each provided with one map of the greater Monwabisi area and one map of Section C. The maps were laminated such that they could be drawn on with erasable markers. Ideas were drawn out and discussed within the groups.

Specifically the groups of four were asked to define possible locations of a school, shopping centers, athletic fields, roads and community gardens on a macro level scale which included the entire park. Groups were also asked to consider a smaller scale within each section for the purpose of discussing locations of things that needed to be in each section, such as crèches, churches, bus and taxi stops, businesses and second tier roads. During the discussion we were focusing on determining the method by which a location could be identified to serve a particular purpose and not focusing on the specific location itself. This focus was designed to provide those involved with a greater understanding of the needs of the community and what would have to be done to help improve community life.

Group 1

The first group consisted of two co-researchers representing

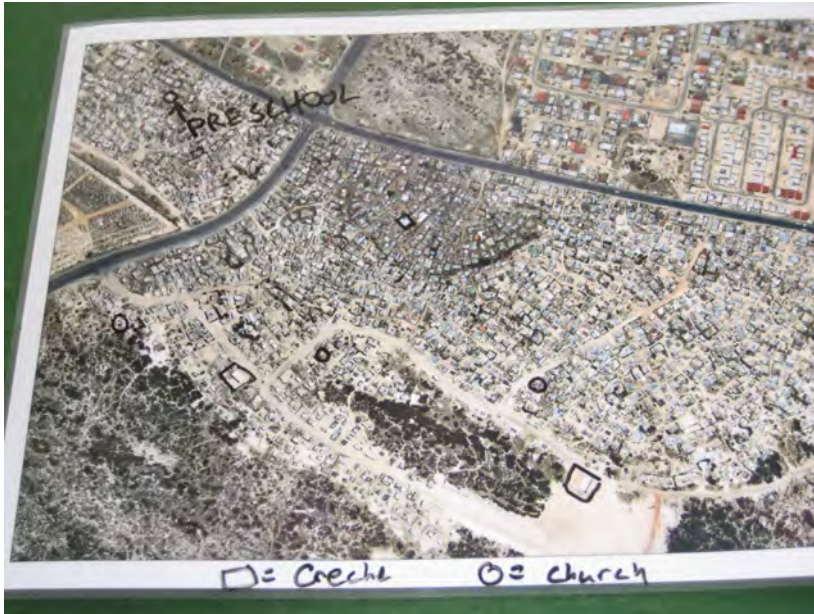

business clusters that were identified before in the section map, and again the group decided that locating them with an even distribution was most important. It was decided that these places could exist near Mew Way where it is safe, one in C Section and one in B section. Areas for soccer fields and gardens were also identified keeping in mind that these have specific geographical requirements. The field was proposed to be located on a large flat empty lot at the back of C Section and a number of areas for gardens were identified throughout the park mostly along the south side. The benefit to locating gardens throughout is that it would yield a sense of belonging and ownership to the individuals they supply, rather than neglected like the current communal facilities are. The end of the session yielded two different levels of thinking for consideration when developing the given area. With respect to the sections and to the entire community it was easy for the informants to convey the many different ideas for redevelopment.

Group 2

This group only had one member of the community in it, and he was not one of the co-researchers. This presented an interesting situation; for the first time in 3 weeks the project team was not working with one of the co-researchers.

The exercise began with the

intent of finding out where the community member would start redeveloping Monwabisi Park, with the idea that we were looking for a way to redevelop the area without displacing large amounts of people. Rather than suggesting a specific place, he suggested that we were getting too far ahead of ourselves. The community member suggested that the only way to do something like this was to gain the confidence of the community, and that the only way to do that was to start with small, tangible improvements. We were reminded that the community as a whole would not understand large scale redevelopment plans if one started on a larger level. Instead, it would be better to start with something that presented more immediate, direct benefits to the community. Then, once the community trusted whomever was organizing such an effort, would they be more willing to listen to and understand larger scale, more time consuming plans.

We then proceeded under the pretense that this trust had been gained, and that the community was willing to support a larger scale plan. With this in mind, we asked how he would arrange the community; where he would put a school, a garden, a field, or other things like that. Yet again however, we were met with a different idea. The most important thing, he said, were better roads. Emergency access is currently nearly impossible, and is impor-

tant to improve. In order to do **this, he suggested that it wasn't** necessary to have a road in front of each house, but rather that it was vital to make roads that emergency vehicles could access around clusters of houses. These clusters were essentially defined by what he felt to be the maximum effective distance of emergency services was (either fire hose range or ambulance personnel accessibility).

From here we tried to move onto shopping areas, schools, and other public facilities. Our community member seemed far less phased by these ideas than of roads, and reverted back to small improvements. The water facilities he said, were in dire need of upgrading. Finding a way to do this would gain trust and provide a much needed service to the community. Time ran out shortly here after.

This exercise brought forth some useful information. While we had realized that this was going to be a gradual effort, the idea of building community trust through small improvements was **something that we hadn't** thought much about. This did however present an interesting dilemma: how do you balance the demand for immediate improvements with the need for significant large scale infrastructure improvements necessary in order to make the community more sustainable? The dependence on outside resources is something that there has never been an alternative to, so it may

the park and three members from the different student research teams. The discussion began with a focus on the existing boundaries of C Section defined by major roads. The group began discussing ideas around roads and their relationship to the community which lead to the understanding that these travel routes can be used to link major congregational areas for the community. Using this idea the next focus became determining what areas should be developed into a community or business center. Using the Indlovu center as an example the group identified 2 other areas in C Section that could be developed with the idea of congregating people into larger groups at business square. Once the squares were identified the group selected existing routes

between them for further development.

This sort of structure helped subdivide C Section into smaller areas that might be considered neighborhoods. Developing these roads would also provide emergency vehicle access to the entirety of the section and not just its perimeter.

The focus then shifted to the larger image of the inter park. The group immediately identified a location for a possible school in the middle of the Park between sections B and C. This area was chosen because it is equidistant from either end of Monwabisi and thus the majority would be subject to the minimal amount of travel. It was then proposed that there could be a few large business centers within the park instead of the smaller

be hard to get this point across to less open minded individuals. On the macro-level side, the desire for roads for emergency access was also important.

4. C section Outline.

The black and white map of existing conditions in C section was made by tracing the aerial flyover image by hand. The travel routes and individual houses were identified visually by their shape, any space between structures that showed evidence of being host to foot traffic was considered a pathway. The outlines of paths and houses were traced onto semi-transparent tracing paper. The drawing was then scanned into the computer and uploaded as a .jpg image and further refined using Image editing software.

5. Use of image for surveying

The C section outline was printed onto A4 paper and given to various groups in need of recording spatial data in the section. The printout would be used for recording data by being drawn on with pens and markers to identify particular areas or even individual houses of interest. For example, the researchers used the printouts when surveying to record which shacks were shebeens. This system would be used to identify and record any number of data layers within C section and provides individuals with an image as common

ground for discussion rather than attempting to verbalize broad topics without aid.

6. Charette #2

The goal of charrette two was to procure the type of information we had gotten from C Section from the rest of the park. We hoped that this would serve to make the entirety of Monwabisi Park feel involved in the efforts that were primarily taking place in C Section, while at the same time gathering as much information for future redevelopment efforts as possible.

Utilizing the opportunity to work with 20 individuals from the community who were trained in security and safety by the VPUU, groups were organized based on where people live to discuss current conditions in sections A, B and M of Monwabisi Park.

Laminated aerial flyover maps of each section were given to their respective groups. Shebeens, shops, crèches, churches and areas of known violence were identified by color coded stickers and markers. A key for the stickers was displayed for all to see describing that red circular stickers would represent shebeens and green, blue and red rectangles would represent crèches, churches and shops respectively. The areas of known violence would be outlined or otherwise identified by black marker. The information from these maps was later docu-



Hand Drawn Map of C Section

mented and uploaded into GIS database.

Section B discussion

Three community members out of the 20 key informants identified themselves as being residents of section B. Together these three individuals were able to identify the points of interest near their individual houses. However, the western third of section B was unfamiliar to them and thus very little information was provided for this part of the section. During discussion individuals were given stickers and asked to identify places one at a time all the while discussing with each other what specific locations they were identifying before unanimously agreeing on the location. The topics were discussed one at a time and the informants were aided by a trans-

lator when necessary. The end result was a very detailed map of B section which portrayed all three informants understanding of their area of the park to best attainable degree.

Section M discussion

For this part of the charrette I worked with one member from M Section, Thandabantu Kolo. This member had received VPUU security training, but had not worked with us before on mapping exercises. Like we had done in C Section, we asked Thandabantu to point out places of importance. We asked about shops, bars, violent areas, and anything he thought was important. At first he was hesitant, but with a little bit of help from one of the co-researchers and some time to orient himself, he was able to provide us with a depiction of M

Section. Without another person from M Section to cross reference his answers there is no way to tell how accurate his answers were, however at this point we have not run into any major discrepancies when comparing information from people of the same section. With this in mind **Thandabantu's information will provide a solid basis on which to move forward.**

Macro-level redevelopment

The discussion of future planning involved one large group consisting of 10 of the security trained community members and 4 researchers. The group worked on a large aerial flyover image with colored cardboard pieces used to represent future buildings and plots of land. The discussion began with the consideration of a centralized school facility and what level of schooling was needed. The group discussed the idea of having several smaller schools possibly one for each section but it was quickly



Community Members, Co-Researchers, and WPI Students working together at the Charrette.

determined that some might be better cared for than others and thus it would be unfair seeing as they would all have the same initial funding. One school could

and the new plan discussed earlier was supported unanimously. The entire discussion was facilitated by an idea presented involving translation of questions

7. Population Estimate

The population estimate is derived from the surface area calculated by the Geographic Information Systems. Using an estimate given by the community that there are roughly 3 people per shack, and roughly 9 shacks per 400 m² it was then calculated that there roughly 40,000 people in the Park.

8. Saving space with organized housing

Using satellite images we defined an area of 29 shacks which are located in a relatively average section of the park, with respects to shack density. First the footprint of each individual shack was calculated in GIS software (as well as the footprint of the



Aerial picture of case study area, highlighted in red, located between C and B section in Monwabisi Park.

require more money than another due to repair from neglectful conditions. The discussion lead to a common belief that having one preschool, one primary school and one secondary school each in its own building spread out around the community center would provide all levels of schooling needed. This system of schools would be supported by a transport system for all to use such that traveling by foot could be minimized. This lead into a discussion of existing conditions which revealed that parents currently take their young children to crèches in Harare as well as those that exist in Monwabisi. This amount of travel was considered unacceptable for most

and ideas presented in English into Xhosa for the group of informants. Though each informant lead to a common belief that having one preschool, one primary school and one secondary school each in its own building spread out around the community center would provide all levels of schooling needed. This system of schools would be supported by a transport system for all to use such that traveling by foot could be minimized. This lead into a discussion of existing conditions which revealed that parents currently take their young children to crèches in Harare as well as those that exist in Monwabisi. This amount of travel was considered unacceptable for most

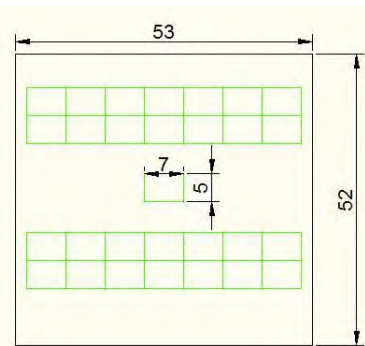

Row house design utilizing open space preservation. In this design each shack is 35 square meters, the average size taken from the case study.

Shack NO.	Space (square meter)
1	44.56
2	40.86
3	18.95
4	32.95
5	41.09
6	22.81
7	49.38
8	32.7
9	11.13
10	23.52
11	26.08
12	48.03
13	60.6
14	33.66
15	29.1
16	24.97
17	47.94
18	25.02
19	43.8
20	43.2
21	33.47
22	55.15
23	30.57
24	15.8
25	19.04
26	54.01
27	31.82
28	32.25
29	35.2
Total space for shack	1007.66
Total Space	2770
Shack Average Space	34.74689655
Total area/No. of shacks	95.51724138
Free space	1762.34

Case study of area showing approximate shack size and free space

entire study area), then we used an excel spreadsheet to calculate the amount of space needed in the area for each the average footprint of a shack is about 95.5 m². (34.75 m²). Then dividing the Organizing even these existing given area (2,756 m²) by the number of shacks within it we

conserve a great deal of space. The standard the buildings team used was that each house within a shared wall cluster would have a footprint of 20 meters squared.

Utilizing the three detailed designs they provided we were able to calculate the amount of area from each cluster that would belong to each shack, including the free space that was worked into the designs. With this number we were able to compare the amount of space that would be saved by converting to one and even two story versions of each new housing design. In the case of the circular patterned housing the amount of space per house is approximately 57.6 m² with one story and with two story its only 28.8 m².

Using the “L” shaped cluster the one story plan would consume 112 m² per house which actually worse than the existing state of Monwabisi's density, however the two story version of this cluster would only use 56.25 m². Finally the row housing design would use 60 m² per house with one story and 30 m² with two stories.

Dividing each area per house in the future plans by the area per house in the existing conditions, we can see what percentage of the existing footprint of the park will be used by the new housing plans. This then shows the amount of free space which can be used for roads, recreational areas, community



Area of Harare used to calculate amount of space used by roads

centers and any other facilities that might be needed.

9. Consolidating Housing to Create Open Space

The image below shows the amount space that can be saved by incorporating an even distribution of the 5 different housing options which effectively reduce the footprint. The area shaded in green is the condensed footprint of an average of the shared wall housing styles. It represents approximately 48% of total footprint of Monwabisi. The area shown in

blue represents the 16.54% area that needs to be devoted to roads. The remainder is an area which represents about 35% of the land area in Monwabisi which can be devoted to developing public facilities.

Road Space

Using a satellite image of Harare we first added up the total length of all roads for a given area. Multiplying that number by 4.5 meters (the minimum regulation width for a road as defined by the city of Cape Town.) we calculated that



Image of Monwabisi Park showing the amount of space that could be conserved by consolidating the housing footprint.

16.54% of the total land in this area is used for roads and sidewalks.

10. Roads Cost Analysis

To calculate the projected cost of the initial development plan (stage 1) of roads in **Monwabisi Park's C section** we first acquired data from the city of Cape Town. For a 4.5 meter wide laterite road consisting of a 100 mm sub base, 50 mm laterite, and concrete edging, the **City Park's Department** estimated a cost of R1,200 per meter. We then calculated the total length of the roads in the first stage of the future development plan, including a semi-circular loop and a road which bisects its interior parallel to Mew Way, totaling a length of 300m. Multiplying by R1,200 per meter, the estimated cost of this particular road plan would be R360,000. Using the same procedure for the second stage (shown on the map) we calculated that the remaining 800 m of road in this area would cost approximately R960,000. The final road costs for stages 1 and 2 of development in C section is R1,320,000.

11. Interview with Basil Tommy 12/05/2008

During this interview we discussed emergency vehicle access. During this discussion we discovered that the hoses that fire trucks use are



30m long, and can maintain pressure with up to three hoses connected. When discussing the fire in Monwabisi Park, it became apparent the major issue was that the **fire truck's hose had been damaged**. This led to the assumption that the fire trucks that service Monwabisi probably only carry one hose, and that it was worth planning for the worst case scenario. During this discussion we also discussed the idea and logistics of utilizing laterite roads instead of pavement for roads within the Park.

12. GIS in Action

In this project, the Mapping Team utilized ArcGIS student package – ArcMap to facilitate data management and data representation. None of team member, however, had ever used this software. One of the Mapping Team spent approximately 2 weeks in the beginning to understand and get familiar with the basic operation of ArcMap by himself. After the initial study, GIS facilitated the project throughout 7 weeks. GIS played a central role in data storage, analysis and presenting.

City of Cape Town has little information about Monwabisi Park except high resolution flyover images of 2007 over Monwabisi Park from

VPUU and Transportation Department; GIS data of water & sanitation from the Water & Sanitation Department. The information from City of Cape Town provides the base for the research team. By using the large scale printed out flyover images, Mapping Team conducted several mapping exercises with co-researchers and other community members from Monwabisi Park. After each mapping exercise, pictures of marked maps were taken. These documented pictures were used to digitize the information into GIS. ArcMap formulate the information majorly in there catalogs: point, line, and polygons. Points are used for represent data like address. Lines can represent roads, boundaries, pipe lines and etc.. Polygons are used for areas. ArcMap drawing

function can make all different information shown in different layers and coordinate to the location on the flyover image. These data include: the location of churches, crèches, shabeens, private enterprises, preschool; community sections; luminous map; and dangerous area. Instead of asking community members, the roads and pathways in Monwabisi Park can be identified by looking at flyover image. Therefore, pavements, roads and pathways were directly drawn on layers in ArcMap. Because the layer function ensures that each data can be shown separately in the same coordinate, the research team can better understand current condition and formulate the spatial redevelopment strategies more progressive. In another hand, the GIS station set up by Mapping Team can also help other research team to understand the current condition in terms of geographical context. Based on the flyover image, GIS measuring function help the team to get some feature of Monwabisi Park in quantity, such as area and length. Another excellent feature of GIS is the buffer analysis. The research team used the buffer feature analyze the fire tuck accessibility, bus stop serve area. The visual presentation of analysis helped the group to revise every design. The practice proved that GIS is extremely useful in managing the collected data and represent the data by powerful graphic.

The information stored in GIS can also be used by City of Cape Town, NGOs and any other people interested in helping Monwabisi Park in the future.

References:

- A) Birgit, Ingrid, Katrin. (July, 2008) *The Development of Monwabisi*. Angenda 21 Partnership Cape Town-Aachen Retrieved on (July, 2008) September 03, 2008 , from . http://www.aachenkapstadt.de/projekte/asa_project_study_monwabisi.pdf
- B) Golden Arrow Bus Service Retrieved on December 09, from <http://www.gabs.co.za/>
- C) Jaksa Barbir Spatial Planning & Urbanism, Corli Havenga Transportation Engineers (2008) *Transit Oriented Development Framework Langlaagte & Paarlshoop*. Retrieved on November 04 from http://www.sacities.net/members/pdfsframework_langlaagte_paarlshoop_1_1.pdf
- D) Utility Services, infrastructure management Engineering, City of Cape Town. Retrieved on December 09.
- E) VPUU. (2006). *Urban Renewal Draft Spatial Development Framework for Khayelitsha Mitchells Plain (URSDF)*. Retrieved October 03, 2008, from <URSDF.ppt>
- F) VPUU. (2006) Harare Safe Node Area, Site Development Plans. Retrieved October 15, 2008, from <VPUU Harare Safe Node Area Site Development Plans.pdf>
- G) VPUU. (2006) Urban Renewal Spatial Development Framework for Khayelitsha and Michells Plain. Retrieved October 18, 2008, from <reportDRAFTFINAL.doc>

Buildings: Places for Work, Home, and Community



CHAPTER THREE CONTENTS:

- 74 INTRODUCTION
- 75 CURRENT SHACK CONDITIONS
- 79 CHARRETTEE
- 81 BUILDING CONSIDERATIONS
- 82 ROOFING
- 83 ECOBEAM
- 88 OUR DESIGNS
- 90 METHODOLOGY
- 93 REFERENCES
- 94 APPENDICES

AUTHORS:

DAN GARCIA
TIM KUNYZ
STEPHANIE SCHULTZ
LAURA TRACY

SPONSOR:

MIKE TREMEER—
ECOBEAM

Introduction: Buildings

South Africa houses a large number of informal settlements, many of which are located within Khayelitsha. These informal settlements are very crowded and the living conditions are less than what the inhabitants would hope for. Even so, it is hard to make an improvement with little money coming into the settlements.

Monwabisi Park is a large informal settlement within Khayelitsha. Over twenty-five thousand people make up this community. These communities expanded quickly and very little planning was taken into account when developing the shacks. These buildings are comprised of corrugated iron and other materials that are inexpensive. The reason that these types of structures are prevalent in any type of informal settlement is because they are easy to construct and require no electricity or power tools to build. They can be completed within one or two days with the help of only a few people. However, these houses do not provide much insulation or temperature control. The shacks are a quick fix to the housing problem, but they are not suitable to live in for any length of time.

The government has tried to offer alternate housing to the shacks. However, even with this effort the government cannot keep up with the demand for housing. Within Monwabisi Park, the Shaster Foundation has played a large role in community structures. It has **donated money to fund a guest house, a clinic, and a backpacker's lodge. Ecobeam has also** contributed to the efforts within Monwabisi Park. Ecobeam has helped build the guest house and backpackers lodge. However, even with these three groups putting in a great amount of effort, the community still needs to undergo redevelopment.

While the government provides individual housing, these developments do not take the lifestyles of the African community into consideration. The houses do not offer land space around the building, which is a necessity for the religious beliefs of the African community. Even though the Shaster Foundation and Ecobeam have been great assets to the Monwabisi Park community, there has yet to be a wider upgrading plan for having put into effect. As of now, these two groups have focused on working within the Indlovu Center. A plan for the redevelopment of the housing in the community is the next step in the upgrading process of Monwabisi Park.

As the buildings team, we have researched and developed structures that can be used for future planning within the park. We have introduced the idea of cluster housing as well as a design for the new Indlovu Project. We have worked closely with Ecobeam and believe their materials will work well for the housing needed in this region. Much consideration of the traditions and lifestyle has influenced our designs and recommendations for the upgrading process of the park. Through our research and analysis we hope to provide a redevelopment process that will be useful and accepted within the community.



View of shacks in Monwabisi Park with False Bay in the backdrop

Introduction: Shacks

In order to begin the building upgrading process within a community, the current housing situation can not be overlooked. It is important to understand the existing problems and changes that need to be made in order to provide an acceptable upgrading plan. Within Monwabisi Park, the housing is comprised of 5785 shacks built by the community which consists of about twenty-five thousand people. Most of the community members have come to find jobs within the nearby cities and have built their own residences in the surrounding areas. They have developed their



own set of skills for constructing buildings and it is necessary to tap into the knowledge and apply it to the upgrading process. In order to bring new ideas and new building techniques to the community, it is important to make sure that they will be able to sustain the building process and continue the upgrading strategy for their community. Therefore, we must first learn from the community and adapt our thinking about building construction to a process that can be utilized by those within Monwabisi Park.

Each individual shack is unique and there is no set size for the structure. Some

may be as small as a 3 x 3 meter structure, others may be 5 x 8 meters, or a two story option is also possible to construct, though very rare. The type of structure that is built will depend on the amount of materials a shack owner can obtain, how big the family living there is and how much space they have to build on. Some build their homes with the intent of having a yard, while others will use the entire space to build a bigger shack. More often than not, shacks will evolve as time permits. Most start with a small one room shack and add on as necessary. The first room that is built will be the lounge. Community and friendship is a big aspect of the African culture. The lounge is where gatherings and parties occur and is usually the first room that will be seen when entering a shack. The shack owner will find it necessary to expand his or her home if family size increases or if enough money has been saved to do so. Often the shack owners will add on a separate bedroom or kitchen to their original structure when expansion is decided.

The shacks are very versatile buildings. They are able to be constructed within one to two days with only a few builders working on them. They can be

easily moved from one location to another after construction has already been completed. The materials used to build an average shack consist of corrugated iron and timber. Most of the structures are built to include have one to two windows and one doorway. Shacks have been used in this area because they are easy to construct, cost very little, and can be built almost anywhere.



These are a structure of convenience for those coming to the area looking for a job. They set up their homes as more of a temporary structure than as a permanent home. Most people within Monwabisi Park do not live there for the entire year and will return to their family in another area of South Africa with the money they were able to make while working in the city. Therefore the homes constructed in the park are not done with as much precision as a permanent residence would. Even though these structures definitely have good qualities for the purpose they are serving, they do not however, provide suitable living conditions

for the environment of Monwabisi Park. The homes are often hard to keep from leaking or flooding, and most do not include any type of insulation. The wind will often blow sand into the building as well as cause the roof to rattle constantly. The buildings are also hard to heat in the winter because of the lack of insulation, and they do not stay cool in the blistering heat of the summer. When designing new living structures, it is important to keep these problems in mind and find a solution through the new buildings.

By visiting different shacks, we were able to learn what the owners liked and did not like about their homes. We learned what the biggest problems with the shacks are, and what they would most like to change. With this information, we will be able to design buildings that will cater to what the community will accept while providing them with a higher quality of living. The community has been very helpful in discussing their housing situation with us and look forward to a change for the better in the future.



Descriptions of Shacks

YOLISILE'S HOME

During one of our visits to Monwabisi Park we took advantage of the co-researchers and took a tour of some shacks in the area. The first shack we visited was quite large and housed Yolisile and his brother. He was very inviting and immediately allowed us to enter his home. When you first enter the home you walk into a lounge with a few chairs and a small entertainment area which includes a television, speakers, and a DVD player. Immediately to the left of the lounge area is the first of two bedrooms. Directly to the back of that bedroom is the second bedroom. Both rooms are quite large and provide a lot of stor-

age. We headed back through the lounge and out towards the kitchen. We were told that this was an addition to the home. It is very common to find shacks in the area that have rooms added on a few years after they were originally constructed. Yolisile mentioned that this addition only took a few days to construct. The kitchen area was very large and contains a microwave as well as a small storage room off to the right side.

The outside space of this home is quite large as well. There is a small walkway that leads to the back of the home where there are many bushes. Yolisile mentioned that when he originally built his home he made sure to make the roof was slightly slanted so when it rained the water would drain down onto the plants. This is very important because not only do the plants provide protection from the wind and rain but they also serves as a fence. Many shacks in the area are designed the same way to assure protection from the wind and rain. The outside area of this home can also be used for gathering. Over to one side of the home is a small sitting area where guests can gather and share stories. The outside area can be used for a

variety of activities. Many shacks in the area have a space



for washing clothes as well as an area for drying.

This shack was one of the newer shacks visited but it already showed signs of aging. When it rained there was a lot of leaking through the cracks of the roof. The rain also caused many electrical problems which would leave the home without electricity for a couple of weeks at a time. The roof also let wind and sand into the home. In order to fix this problem Yolisile put newspaper into the cracks for some protection as well as insulation.

Ventilation is another concern in the shacks. Yolisile said that during the summer months the home would get extremely hot and during the winter months the home remained cold. This shack as well as many others are orientated so that the sun shines into the front of the home during the

winter so the home would have some warmth.

JUSTINA'S HOME

The next home we visited experienced the same type of problems that Yolisile had. This home is owned by Justina, who is the mother of three children. When first entering her home you walk into the kitchen area and directly to the left is the lounge area. The lounge area of this home was small and consisted of one couch and no entertainment area. Unlike the first home we visited this shack had a combined living and kitchen area.



Just to the right of the kitchen was the one and only bedroom in the home. It is very common to find only one bedroom in a home for a very large family. Usually the family shares one bed in the home. When walking around the home we noticed that, like the last home, there were many holes in the roof and around the edges where the roof meets the wall of the home. Again there was newspaper in the cracks to keep out wind and rain. The newspaper also provided some insu-

lation to the home. A lot of work was put into the design of this home especially in the outside area. The outside space of this home is extremely large. When asked what the front yard of the home was used for Justina replied that is was mainly used as a play area for her children as well as an area for clothes washing and drying. Like many other homes in the area, as well as the last one visited, Justina planted bushes around her home in order to provide her home with protection from the wind and rain. Although the home is orientated so it gets the optimum sunlight and least amount of wind, there is still a problem with sand entering the home. When large gusts of wind come through they pick up sand and it enters the home through the cracks at the bottom as well as the top. Justina put small pieces of tin at the base of her home to protect it from the wind and sand. It has proven to be a great blocker from these elements. Small tires have also been placed at the base of the plants to add more protection as well as to provide a baseline for her yard.



Buildings 73

Description of Shacks

FAKU'S HOME

The third shack we visited had been owned by Faku and his brother for the past few years. The outside space is extremely large and has two separate structures occupying the land. One smaller shack off to one side of the area is occupied by **Faku's brother while Faku occupies the larger structure.** This shack is unique because it

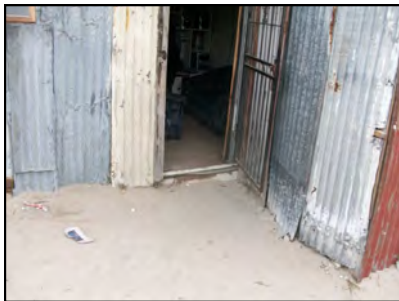

has a tavern attached to one side. The main part of the larger shack has a small kitchen area as well as a small bedroom off to one side of the structure. Just like the previous two shacks visited, this shack had problems with the roof during rainstorms. The roof has many holes in it and leaked during these strong rainstorms. Like the other shack owners, Faku uses newspaper and whatever he can to patch the holes and hopefully prevent as much wind and rain from entering

the home. There was some thing that was different in **Faku's roof than we had seen at the other homes.** The corners were tied down with a small wire to prevent the wind from lifting up the edges of the roof. **It's a great idea which proves to be working quite well.** Faku had also mentioned that he lives in a very flood prone area. Because of the risk of flooding Faku made sure to raise his home slightly to prevent any rain from entering the home.

Faku has a very large outside space in the front of his home. **The area is so large that Faku's brother has enough room to get a car in and out to his shack on the other side of the yard.** (Unfortunately the car is currently not working and they haven't had the opportunity to repair it.) Along the edges of

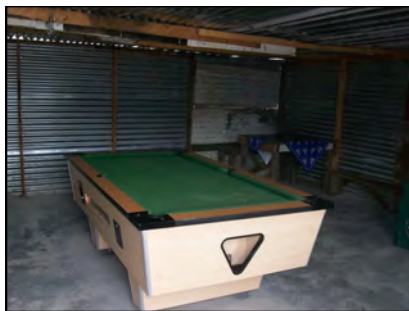

Faku's yard is a small fence as well as small bushes for added protection.

Faku and his brother also

operate the small tavern attached to the larger shack. The floor is completely made from concrete and is elevated a few inches to protect it from the flood waters. Inside the tavern are a couple of pool tables as well as a few areas to sit and gather. We talked to Faku further about his business and he said that he had constructed it a few years back and continues to make additions as the years go on.



FAMILY HOME

The final shack we visited was occupied by a mother, father, and their two children. When you first enter the home you enter the lounge area and off to the back of the lounge is the kitchen. This is the first house that we have seen that has a refrigerator as well as a stove. One of the first questions we asked the owner was how badly her roof leaked during heavy rains because it seemed to be a problem with

every shack we had visited. The owner mentioned that it leaked a lot when it rained and that it gets extremely hot during the summer months and very cold during the winter. One of the things that she would like to have improved is her roof as well as the flooring. Currently in her home is a laminate floor but she would like to see a concrete floor because it resists the flood waters much better. One way the owner made sure her house was protected from wind and rain was that she raised her home a few inches. These few inches will help protect the home from the high winds which could blow sand in. It also protects the home from the rain which could cause quite a bit of flooding.



When we continued to the outside of the shack we noticed **that the owner's yard wasn't as big as the previous three shacks visited but it was still used for the same purpose.** Her children used the yard for playing and she used it for washing her clothes as well as drying them.

As with all the homes that



were used to build the homes were either bought from one of the stands on the road or from surplus materials from building projects.

One common theme that we found is that all the shacks have a problem when it come to wind and rain. The owners try



their very hardest to protect their homes from these elements but the rain still enters through the cracks in the roofs. Most of the shack owners put newspaper or clothes into the cracks of their homes. So far it has proven to be a useful way to keep out the wind and rain but it unfortunately needs to be replaced quite often. Many of the homes are also raised to add the extra protection the home needs from the elements.

Shacks: Costs, Quality, & Construction

- **Overview**

The building units present in informal settlements may appear, to the uninitiated, as very rudimentary structures. Whereas they are certainly not "up to code" as it would be viewed from the perspective of a contractor, the shacks do offer some advantages to offset their list of disadvantages.

- **Quick construction**



Most readily apparent is the speed with which these structures can be erected. Structural members are needed only to frame the building; a square shack's entire framing can be assembled and erected in the space of an hour. Holes are dug for posts at the four corners of the edifice, approximately 50cm in depth, and the posts are sunk to this level and footed by simple earth. Corrugated metal cladding is also



affixed to the structure's perimeter in a relatively short amount of time. Most shacks can be built and inhabited in less than two days.

- **Easily moved**

Given the small amount of materials used in the construction of a shack, these buildings are also quite easy to move. The greatest difficulty in relocating a shack would be the transference of material goods contained within its walls, such as clothing, furniture, and appliances. In general, the roofs can be kept intact during relo-

cation, and in some cases the walls can also. However, due to the manner in which the walls are constructed they must usually be dismantled for lack of support.

- **Low cost**

Structural materials needed for a basic shack cost far less than conventional materials for a house. Three meter timbers cost about R45, and sheets of corrugated metal that measure 1x3 meters cost about R55. So, a shack with a 3x3 footprint would require:

8 timbers (four vertical, four for roof frame) - R360
15 sheets metal (3 per each of 5 surfaces) - R825
Total approximate material cost: R1185.

Labor costs can be ignored in most cases, as the shacks are usually built by the intended occupants. The occupants are typically assisted by friends or family, and a half dozen people is sufficient to erect a functioning shelter over the course of a day. However, there are entrepreneurs who charge R2500 for a shack, which includes construction. Either way the overall structure cost is far less than that of other building methods. The use of tools, too, is minimal



- a shack can be erected with a hammer, a saw, and a shovel.

There is a very large degree of versatility in the nature of shack construction; it is hard to say that there exist any "types" of shacks because each shack is custom-tailored by the occupant(s) to suit their individual needs. Adding on to an existing shack can be done quickly and easily, as adjoining to an al-

ready existing wall effectively reduces the amount of work and materials needed by 20%. Flooring is typically rolled linoleum or carpet, and in some cases flat stone, brick, or even concrete is available but these are not common. Windows and doors can be purchased locally and installed using the same timbers for framing. The interior walls are usually lined with ceiling board, which can be sourced locally from anywhere between free and about R10 per square meter. In some cases other materials are used for interior walls, such as cardboard, fiberboard, or asbestos tile.

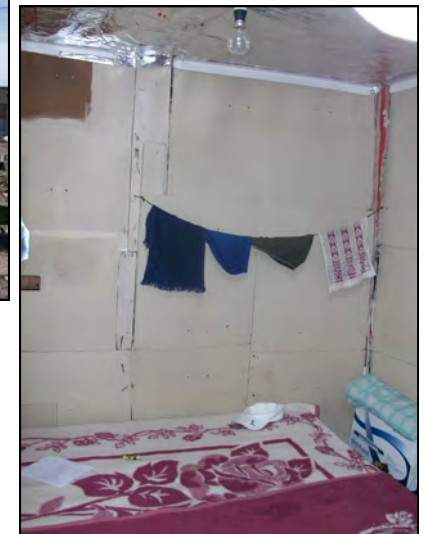

Charrette

Upgrading the settlement is a very involved process which requires input from a multitude of sources. A charrette is a very useful tool to aid in gathering ideas and opinions that will be useful to the future project. Not only will new ideas learned be helpful to include in the upgrading process, but also, our ideas as a team can be considered by the community and other professionals involved in the upgrading project. Our ideas can then be assessed so that we learn if they will be accepted by the community and will be feasible to pursue in the future. A charrette is a great type of meeting to hold because it can involve a large group of people which will generate new and useful information to incorporate into the planning.

On November 14, 2008, we held our first planned charrette. A charrette is a large meeting in which people from different backgrounds gather to collectively discuss a topic. The subject usually focuses on macro and micro-level redevelopment. While we held a charrette in a few hours, a charrette

can last up to four or more days. This is an intense discussion session in which everyone participates and gives opinions on the subject at hand. Since people with differing knowledge and experiences are present, a multitude of different ideas are presented which is optimal for the designing process.

As a large group, the WPI IOP team members as well as community members, community leaders, project sponsors and other professionals gathered to discuss design models for upgrading the current housing in the park. We were very happy that some of the Street Committee was able to attend the charrette because they have the final say in what will be allowed in Monwabisi Park. The first topics discussed included single house upgrading and water facility design. From the building designs we learned that a two story house is acceptable, and well liked among the community. However, only one family can live in a two story complex, families can not live above another. The second half of the charrette focused on macro-level design and cluster housing complex. The Street Committee was extremely helpful in teaching us what type of housing arrange-

ment would be accepted. Cluster housing is a new concept to the community, but if implemented, ground area can be freed up for other activities, such as gardening and playgrounds for children. They responded well to the cluster designs and were excited at the prospect of working these new ideas into the community. These designs can then be taken and used to create and plan other charrettes that could involve models or other types



of designs. The information received from the charrette is extremely useful and can be taken and used to construct other larger designs or be scaled down to fit into a smaller area. Once we got a sense of what the community was looking for, we could add in other elements to the design such as water and energy¹.



Shacks: Issues, Maintenance, Repair

The numerous benefits offered by shack construction in Monwabisi Park are offset by the need for near constant maintenance as well as issues that the tenants must live with.

Roofing is of particular concern to the residents. The most widely used corrugated tin roofs are extremely susceptible to leaks. Even freshly galvanized sheets are weathered by the high winds and abrasive sandy conditions. Holes and rust plague a majority of the residents of Monwabisi Park. Yolisile considered himself lucky: only the roof in his kitchen leaks.



The most common solution documented involved plugging up holes from the inside using newspaper. Justina pulled a cloth out of a relatively large hole above her front door. She told us she had bought the cloth to hang in the doorway, but it was doing a better job where it was.

In the dry season these methods are barely adequate to keep out the sand and wind. However, newspaper and cloth do nothing to keep out the water in the rainy season. Then small pieces of tin are used to patch over holes on the top of the roof, but only where absolutely necessary, as it **is more costly and doesn't guarantee a leak free home.**

Low roof pitches and rocks laid on top of the roofs help to minimize the effects of wind. This, however, leads to sagging which prevents efficient runoff and causes pooling. The only real solution to this (short of completely replacing the roof) is to try to reinforce it with cross beams from below. There was a large **bulge above Justina's kitchen** surrounded by a matrix of timbers. It was here her roof leaked the most, and she simply could not afford to patch it completely. She pointed to a stack of buckets and told us that they fill quickly in the rainy season.



Flooding is another serious concern. Many shacks find themselves below the water table and are left sitting in water as deep as a foot or more. Even shacks located on higher ground are susceptible to rivers of water flowing through their front doors.



There are two common ways of dealing with the ground water. Faku as well as the third house had a raised cement footing that kept their floor above the level of standing water. This scheme worked perfectly, save the few times the water rose above the cement level. Faku pointed to his couch and told us that last June his wife had been lying there, completely surrounded by water. There was nothing they could do at that point.

Justina dug tin sheets into the ground at the base of her house which she claimed aided in shedding water. Raised floors are found to keep the sand from blowing in the doors in the dry season as well.



Those having to deal with flowing water must find a way to create a barrier. Low sand walls were implemented and in some instances reinforced by vegetation to prevent erosion. One man who was in a particularly bad spot had constructed a wall of tires to deflect the water. However he was quick to highlight the flaw in this solution. Staring down the path he was aware of two or three plots that he had deflected the water towards. The water must go somewhere, flooding either shack owners or those trying to walk down paths.

Tightly clustered shacks constructed from timbers and insulated with plywood are at an extremely high risk for catching and spreading fires. Rarely does a single shack catch fire without taking a whole block of shacks with it. In a five month period two separate shack fires in C1 engulfed a total of over 35 shacks, destroying possessions and leaving many homeless. This is a higher than average figure, however the truth remains. Fires are a part of life for those living in Monwabisi Park and their shacks do nothing to help protect them or their belongings.

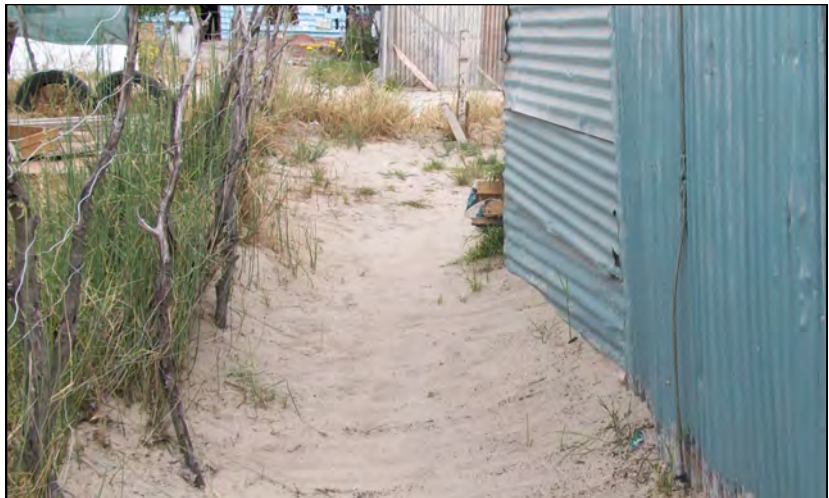

Building and Design Considerations

When constructing a building it is important to keep certain elements of living in mind. In Monwabisi Park we are not simply trying to put up structures for the community to move into, we are trying to make informed decisions on what will be useful and improve the quality of living within the park. We do not want to simply provide a shelter, but rather a home that the community members of Monwabisi Park will be proud to own. We will not be forcing a building design on the community but rather working together with them to produce a living space in which the community will be excited to have.

Emphasizing simplicity is an important aspect of designing a building in Monwabisi Park. When designing a home, it is important to make sure the building will work for the people who will be living in it. How a person lives needs to be taken into consideration. If they like to wake up early, they may want to have their bed-

room facing north or north east so that the morning sun will wake them up. If they like a lot of light in their kitchen, they may want that room to be in the north end of the house with bigger windows. Finding out the traditions and habits of those who live in Monwabisi Park will be helpful in developing models that will best fit

their needs and daily routines. It is important to stress the necessity of attention to the outside elements when designing a building in Monwabisi Park. In the summer, the sun is higher in the sky than it is in the winter. Therefore, in order to keep warm in the summer and cool in the winter, the windows must be built into the structure to maximize heat from the sun in winter, and reduce it in the summer. Another element component to keep in mind is the wind. There is wind all year round and it can be destructive to the buildings. The wind will blow sand into the home if the doors or windows are not positioned correctly. The rainy season occurs during the winter. Many of the shacks now do not have adequate roofing that keeps them completely protected from this element. Many of the current roofing structures leak and new designs will need to factor in all the elements to insure that there is an



improvement in the living conditions within Monwabisi Park.

When designing a structure, a multitude of factors and considerations must be taken into account to produce a useful building. The interior is as important as the exterior and the materials used to construct all of it.

Taking into consideration our studies, input from the community, and researchers we have come up with some optimal designs. Two main groups of people are considered in these designs; large families and single occupants.

Surveyed parties were found to have common wants and needs in a living space; these considerations were factored in accordingly. Other design features such as clustering, orien-

tation, energy & water demands are discussed to come up with the best design, this is not to rule out any facet of future designs. The ideas presented in this section are simply that—ideas. They blend community preference, expert input, and our best thinking to produce some structures that would accommodate these various principles.



Roofing

The roof is one of the most important components in the design of the structure. The roof protects from the elements outside, whether it be the beating sun or the blowing rains. It is necessary to make sure that the building is able to stand up against the elements as well as being comfortable and enjoyable for the owner.

There are many considerations and types of roofing to consider when designing a home. The gable roof is not good for high wind areas but on the other hand it has very good ventilation. The hip roof stands up to high winds very well because it is braced at all ends of the home but unfortunately it takes away from the interior space of the home. One of the cheapest roofs to construct is the shed roof style. It requires the least amount of materials and allows for water to drain to one end of the structure. The flat roof, which is the most common style of roofing in Monwabisi Park, is also extremely cheap and uses the least amount of materials. The flat roofing can also be slightly slanted to allow rain to drain to one end of the structure for collection.

Insulating and waterproofing a roof is also necessary, as most of a building's heat is lost through the roof, and most of

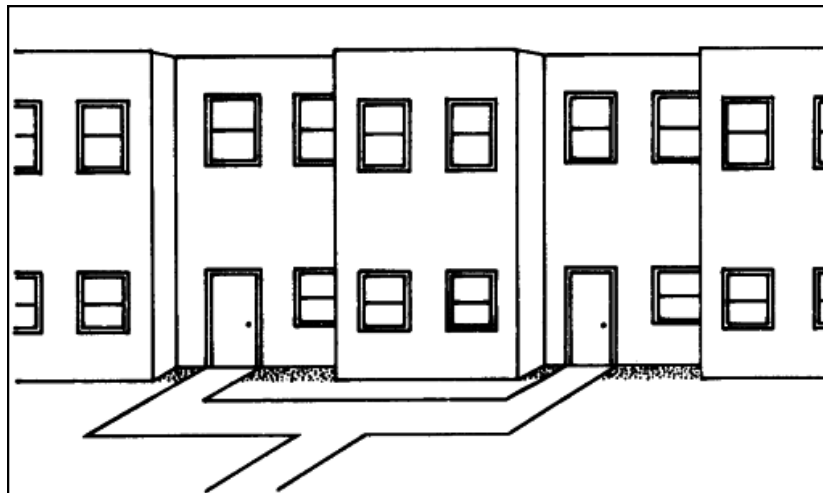

<http://content.answers.com/main/content/img/barrons/realestate/>

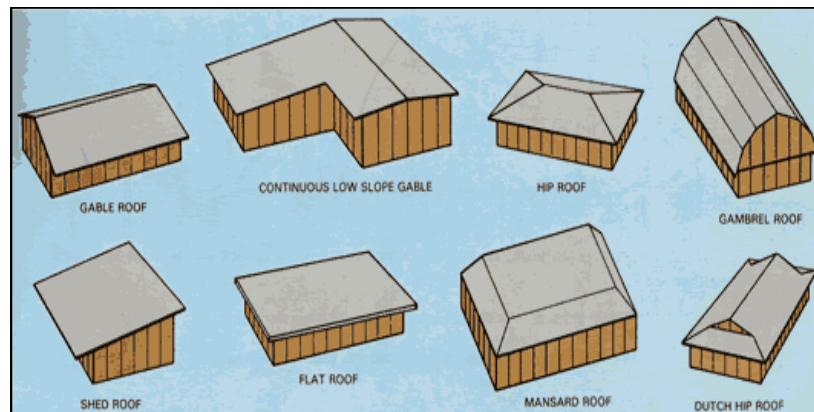

the roofs in Monwabisi Park were found to leak water. Many insulation options are available, but a significant portion of these are too expensive or environmentally unfriendly, making them poor candidates for use here.

Blown cellulose is both a cheap and ecologically sound option. Polystyrene boards are not as environmentally friendly, but are available at relatively low cost.

A roof design with Ecobeams as the primary support, will have plywood and waterproof cladding on the outside, and insulation on the inside. This will add very little to the dimension of the Ecobeam, but

will contribute much to the interior comfort.

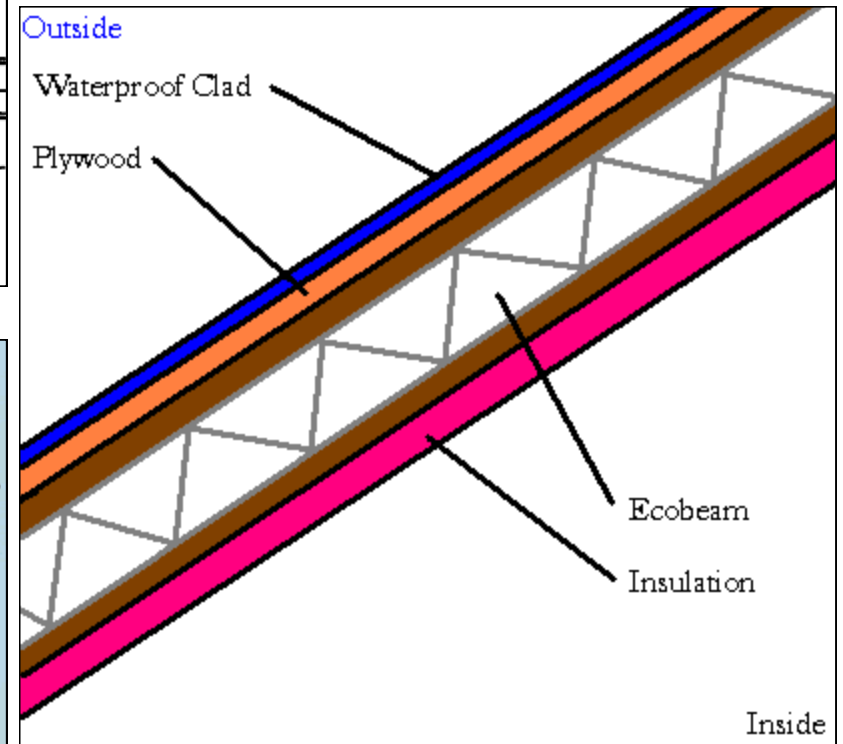

Ecobeam

We will be working closely with Ecobeam throughout the redevelopment process. Not only does Ecobeam live up to the eco-friendly aspect its name implies, but it is also very cost effective. Much less materials are needed in order to produce an Ecobeam house than most construction calls for. This company has already donated materials and buildings to Monwabisi Park and is a continued presence throughout the upgrading process.

Ecobeam is a South African based company that focuses on eco-friendly building methods. The owner, Mike Tremeer, has donated two buildings to Monwabisi Park as of December **2008: the Makazi's guest house** and the backpacker's lodge. Ecobeam is looking to continue relations with the area and has helped to coordinate a sandbag

sewing factory and is considering constructing a full Ecobeam factory in the park.

The Ecobeam factory is extremely small but can make hundreds of Ecobeams to accommodate various types of structures. They have recently completed a large shipment of Ecobeams to Madagascar for a large scale project. Not only do

they work on large scale projects but smaller ones as well. They have recently been working on a small restaurant for the area. Ecobeam has many uses and virtually anything can be constructed in the Ecobeam Factory.

Producing the beams is a simple and highly manual process. In the current factory, very few power tools are used. This minimizes operational costs while optimizing job opportunities. Assembly of the structures is a relatively simple process that can easily be taught to members of the community. Labor involved in the erection **of the backpacker's lodge** was supplied almost entirely locally. Children were able to help fill the sandbags, four skilled workers were selected from the community to put up the framework and countless others have lent a hand in the process^B.



Ecobeam/ Construction

The structure of Ecobeams are unique and is constructed with almost no machinery. Even though no machinery is used the beams can withstand very strong loads . When building with Ecobeams it is very important to follow certain guidelines in order to get the maximum use out of the structure. Different lengths of beams require different kinds of support and different size sandbags are used in certain parts of the home. The cost of each kind of beam and sandbag vary but are still fairly cheap.

Ecobeam structures contain three main components: beams, sandbags, and infill. The beams are constructed of a steel lattice sandwiched in between two wooden boards. Depending on strength needs, these boards can measure 1.5 x 1.5 or 3 x 2. Wall studs are priced at R17/m and must be

placed no further than 0.9 m apart. A different beam is used to support the floor as well as the roof and costs R45/m. However supporting the second floor requires spacing no greater than 0.4 m. These beams alone can comfortably span 5m. For lengths between 5 and 7m, one side of the beam

must be clad; and for lengths from 7m up to 10m both sides of the beam must be clad. Cladding one side effectively doubles the cost of the beam and cladding both sides effectively triples the cost. Thus, distances greater than 5m must be avoided. The roof beams can be spaced at up to 1.2m as there is a relatively small load on these beams. However, this may need to be shortened if equipment is expected to be placed on top of the roof.

The sandbags come in two sizes: 0.3 x 0.2 x 0.08 (m) and 0.3 x 0.3 x 0.08 (m). In general the larger sandbags are used for the exterior walls while the thinner bags are reserved for interior walls. The sandbags provide a high level of insulation, sound reduction, and fire protection to the building. A large R insulation value is provided by the bags. R value speaks to the ability of a material to resist a difference in temperature, namely between

the inside and outside temperatures of the wall. It takes roughly 55 bags to fill a square meter of wall. This puts the price to cover a wall at about R55/m² for the exterior walls and R44/m² for the interior walls. In fire tests, it was nearly impossible to ignite the exterior of the structure using a blow torch due to the rapid rerouting of the heat from the point of contact out into the wall of sand. Once the torch had finally pierced the structure, the sand was released from a bag, immediately extinguishing the fire. The only known weakness of the sandbag is that it rapidly deteriorates when exposed to UV radiation. Inside a wall it is not likely to receive much UV light, however during the packing, storing, and transporting processes the bags need to be protected. Sands with slightly larger clay contents have been experimented with. If wetted during the packing process, these sands can help to retain their shape even if the bag has been compromised.

Once the walls have been filled with sandbags there are two common options for finishing the wall: plaster or shutter board. Plaster is relatively cheap and can cover walls of any shape easily. Shutter board is argued to be more aesthetically pleasing but at both a material and labor cost. It is priced at R90/m² compared to R30/m² for the plaster. Shutter board comes in standard

lengths and must be cut and then fitted to the wall. We discovered through observation of **the backpacker's lodge** construction that this results in wasted end-piece materials as well as a rather slow and laborious cladding process.

The floors and roofs are covered with plywood which is cut from 2.4 x 1.2 m sheets. For the floors the thickness of the plywood is 21mm. The roofs are slightly thinner at only 18mm. The costs for each are R230 and R210 per sheet respectively. However additional material must be accounted for, as not all floor plans can be cut precisely from a 2.4 x 1.2 m sheet, and waste material must be accounted for. As observed **in the backpacker's lodge**, the actual fitting process is left up to the builders. This may result in fluctuation in cost and waste material; however the four builders did a spectacular job of minimizing waste and finding a place for each cut piece, no matter how obscure the shape.

One building element that is apparently missing is the foundation. A major advantage of Ecobeam structures is their lack of foundation, even for two story buildings. This is particularly important in Monwabisi Park which is situated on an old landfill with inconsistent soil conditions.

A costing spreadsheet is provided in Appendix A to cost out Ecobeam structures.



Floor plans/ Orientation of Homes

The orientation of the home within Monwabisi Park is very critical. Depending on which direction the home sits in relation to the sun can greatly affect the core temperature within the home. Because of this many shack owners place the lounge in the front of the home in order to receive the maximum amount of sun throughout the day. The sun, wind, and weather are important in the way homeowners construct and orient their homes.

All surveyed parties showed an interest in every possible amenity a house could offer; however there was agreement on several basic needs: bedrooms, kitchen, and sitting rooms. All parties agreed that a shared toilet facility would be acceptable based on a certain number of toilets per capita, eliminating the need to design for an in-house toilet*.

Different densities of inhabitation do require different considerations in the design of a structure. Clearly, a home occupied by either a single person or a couple does not need the same space as a home occupied by a large family.

An optimized floor plan for single residents allows for half the space to be used as an accommodating bedroom, while the other half serves as a sitting room with a small kitchen area with a half-wall divider.

For a family, space can be nicely divided into two stories to minimize the footprint, given

the shortage of available land. The upstairs space would serve as bedrooms, and the downstairs a larger kitchen and sitting area than the single occupant design. Once the density of a single structure is found to reach a certain point it may be sensible to incorporate a toilet. The entrance to this space should never face the kitchen space, per the community response. Residents also agreed that interface with the outside should occur through the sit-

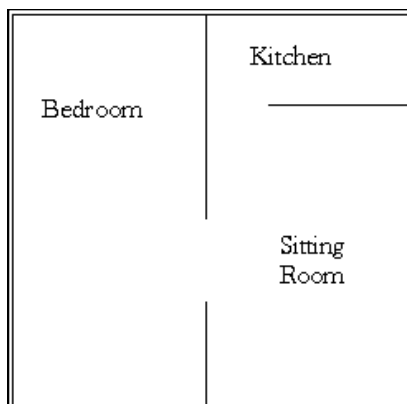

ting room, so that guests can be welcomed and seated immediately.

The orientation of the buildings in relation to the environment has implications as well.

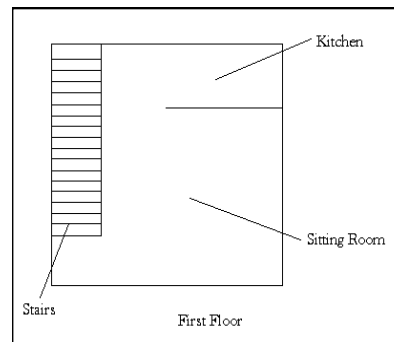

The seasons have various levels of sunlight, wind, and rain that will have to be either utilized or protected against. The next section will discuss in detail the importance of the environment and orientation of house design, specifically regarding the **effective use of the sun's natural heating energy.**

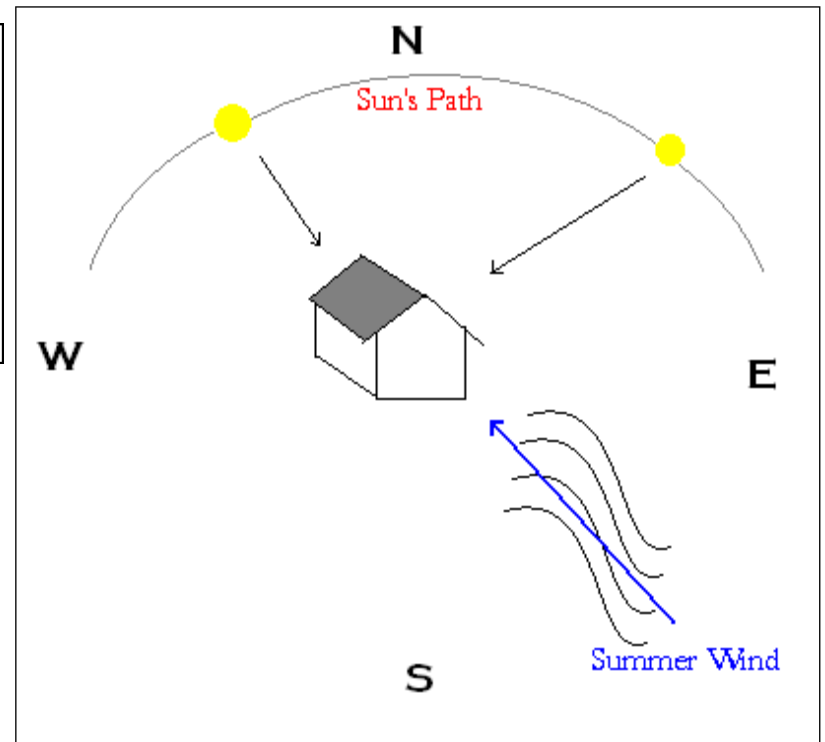
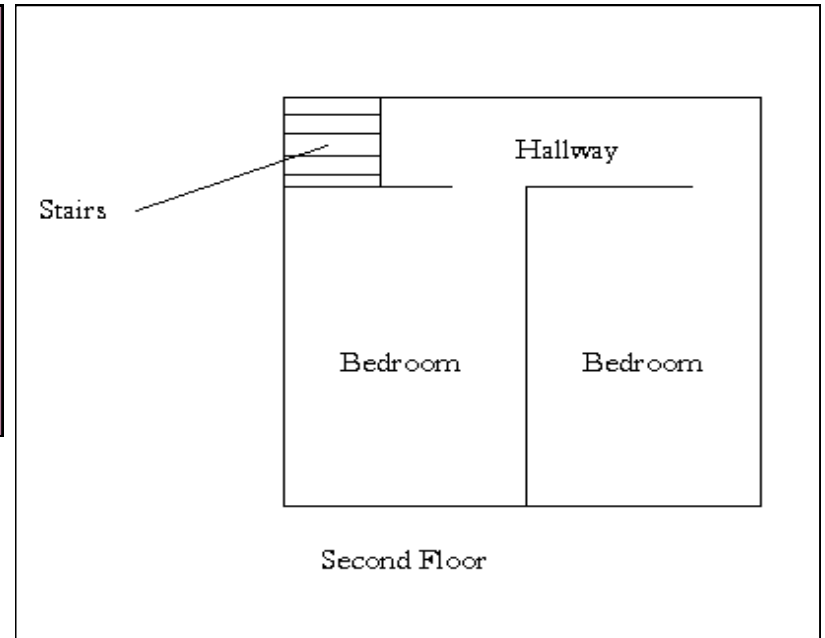

* Toilets are left out of the following designs based on the assumption that a communal facility will be part of the overall neighborhood plans.

Passive Solar Design/ Exterior Considerations

When designing and constructing a cluster unit it is very important to consider the position of the cluster in relation to the sun as well as the exterior space. The sun can greatly affect the temperature of the home. If the home does not get the proper sun in the winter the home will be too cold and if there is too much sun in the summer the home will be extremely hot. The exterior of the home is just as important as the orientation to the sun. The members of Monwabisi Park find it important to have an exterior space in order to garden and use for other various activities.

Orienting a structure in relation to the equator can have a very significant impact on its heating and cooling^A.

The sun will always rise in the east, travel a path near the equator; and set in the west. **Because of the earth's tilted axis**, this path will vary between the Tropic of Capricorn and the Tropic of Cancer.

The manner in which a building is constructed should be chosen in such a way that the longest, most windowed wall is facing the equator—north, in the case of Monwabisi Park. Putting windows in east

and west-facing walls will also allow for the utilization of the morning and evening sunlight. In this way, the majority of a **structure's heat in winter can be gotten—for free—from the sun.**

Shading of these windows, too, is necessary in the summer because the best way to cool a building is to not let it heat up to begin with. Because of the **difference in the sun's azimuth** between summer and winter, a simple roof overhang or awning can be placed such that the sun is let in all day during colder months, and blocked for a significant portion of the day during hotter months.

A thermal mass is called for in passive solar design—this is a material which is capable of absorbing heat and slowly releasing this heat. Concrete is one of the cheapest and most widely use materials for this purpose. Most modern designs call for the walls opposite the windows to be thermal mass in

addition to the floor. However, even with concrete this is not a viable option for building in Monwabisi Park as poured, formed concrete walls would take a significant amount of outside labor and machinery to install. The floors, however, would be much easier to pour as no significant form of scaffolding is needed.

An attribute of the Cape Town area as a whole is a very strong and persistent summer wind. This wind is typically southeasterly, and would affect the south and east walls as a consequence of optimal solar orientation.

This can either be mitigated or exploited (as with wind generators). Monwabisi Park is home to fast growing bush that is easily transplanted; this can be used to both block the brunt of the wind and serve as a root system to keep the ground drained and stable. Aside from the importance of orientation of buildings, the uses of open

spaces around the shack should be considered in any design.

Access to open ground has several meanings to the residents of Monwabisi Park. In accord with the global view of land, it is of course area for agricultural purposes. Also, outdoor areas are desired for gathering and socializing, as well as places for children to play and for washing and drying laundry.

A significant portion of the Xhosa need access to the earth for talking to their ancestors, an activity which could be likened to the prayers of any culture. The ground is proprietary to a family and cannot be shared by people of different ancestry. So, some housing will need to incorporate an unshared plot of land that can be used for this purpose.



<http://newsimg.bbc.co.uk/media/images/42370000/jpg/>



<http://shareafrica.org/images/54.jpg>



<http://www.gigiclimbskili.com/images/gardening.jpg>

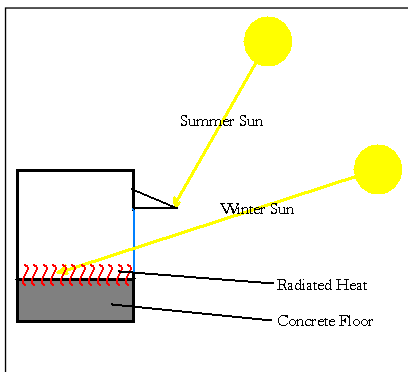

Clustering

Clustering of homes is one way to open up space for additional buildings or gardening. There are many different approaches to cluster designs and each has their own advantages and disadvantages. Because most cluster designs involve the sharing of walls, money is usually saved during construction. If you build vertically you not only benefit from the shared walls but you also gain land space for other activities as well. It is very important to consider all advantages and disadvantages of each cluster home design.

Most buildings in Monwabisi Park are stand-alone; one unit serves to house one family or business.

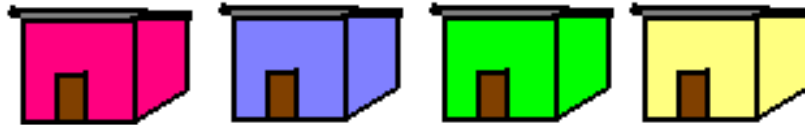

Horizontal clustering has the primary benefit of shared walls; this dramatically reduces the cost of building as the materials for two walls are effectively used once.

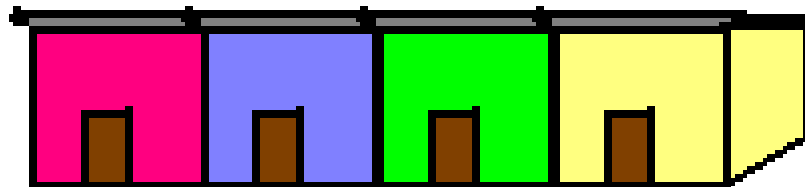

Vertical clustering's primary benefit is in land use; by stacking houses or rooms on top of one another, the footprint of four separate buildings is now condensed.

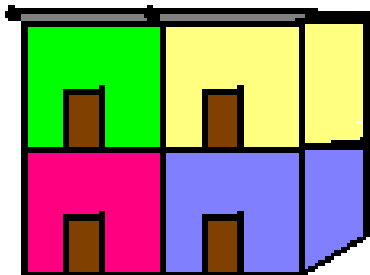

The density of structures in Monwabisi Park is one of the most multi-faceted issues present there. The list of disadvantages includes, but is not limited to:

- Fire risk
- Poor land utilization
- Difficult access to areas by vehicle
- Obstruction of vision for community watch

Planning the clustering of several buildings would serve to eliminate or otherwise decrease many of these risks. An additional benefit of reduced cost of construction is also an immediate advantage, allowing the same sum of money to be used for more housing that shares walls or footprint.

Fire risk would be best mitigated by constructing with materials other than timbers or wood. Sandbag and plaster construction would discourage the spread of fire. Concrete or cinderblocks would serve the same purpose. Even if some large fire were to occur inside one building, the chance of it spreading outside the building would be greatly diminished.

The designs seen previously for single-unit occupancy can be easily extrapolated into a number of clustered schemes. Because of the limited amount of space in Monwabisi Park, it is the recommendation of the WPI Buildings Team that most structures, especially those that

will serve as homes, are designed as two-story units. This will allow for the utilization of land for any number of activities, and can even open up enough space for a communally shared outdoor facility such as a basketball court or small soccer field.

Some of the freed-up land could then serve to bolster existing pathways, widening them into bona fide roads. Vehicular access means many things, including the effective response of ambulances, fire trucks, or police vehicles.

With the current layout of Monwabisi Park, it is difficult **to gain a perspective of one's** general surroundings due to the visual obstruction presented by the building layout. This creates many areas that are sectioned off from public sight, and present an opportune area for such crimes as robbery, rape, or drug dealing.

Other sections of this publication deal with the prevention of crime through urban planning in more detail; however it is necessary from a buildings perspective to be aware of the necessity of embracing a panoptic sense in the configuration of any neighborhood block.

Further Design Options

Our designs have incorporated all the knowledge we have gathered through working with the community and other professionals. We have thought about religious and social implications that are important for the housing designs in Monwabisi Park, as well as the external weather conditions that are present. Through our designs we are hoping to provide a home that will improve the quality of living through different strategies that have not yet been applied within Monwabisi Park. These designs will not only provide a place to live, but also incorporate outside space to be utilized by the community.

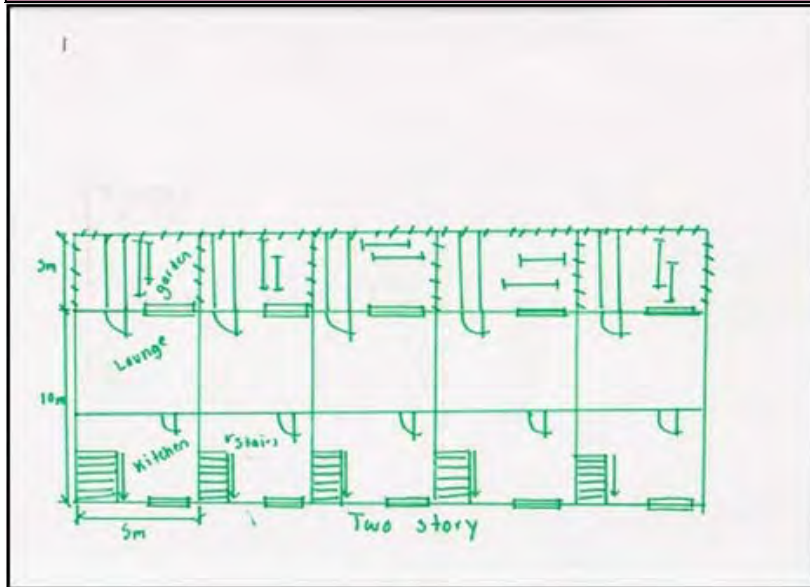

A simple row housing concept (above) has two stories and would rely on an external water facility. Each unit would have its own land plot for gardening and other purposes. This design incorporates a foot path and possible interface with vehicle roadways.

The crescent complex (top right) offers panoramic view of its interior and allows for inclusion of water facility in lieu of one housing unit. The interior courtyard would be protected from wind as well. Thirty-degree openings in opposite sides allow for continuity of exterior pathways or roadways.

The structure's overall geometry encourages maximum densification-to-footprint ratio. The radial geometry also allows a central rain tank to be equidistant from all roofs.

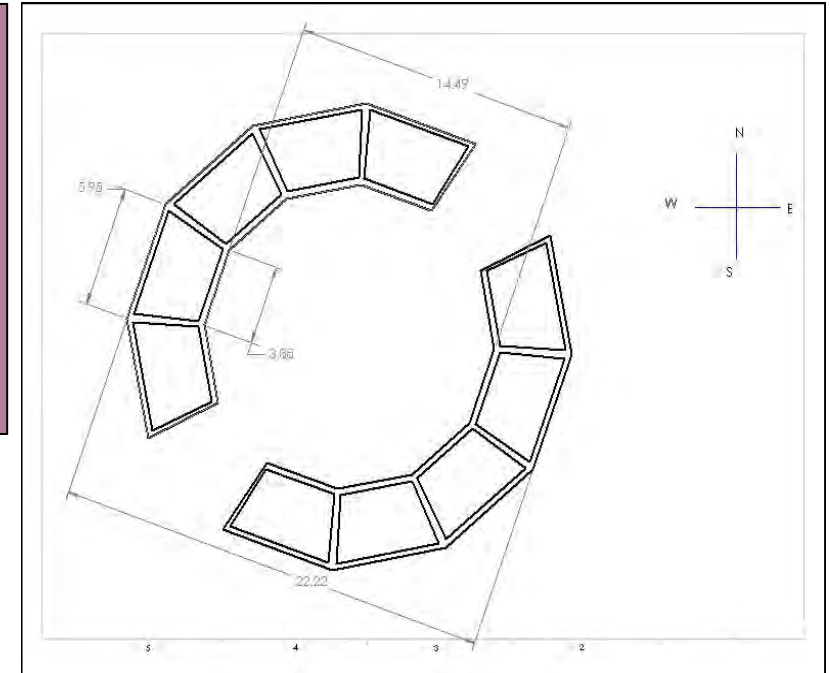

The L-shaped cluster (lower right); overall geometry allows for good wind protection if "aimed southeast." The differently shaped corner room is ideal for incorporation of a community room or water facility. The design concept encourages the remaining plot space to be utilized for both personal land space and a shared garden area. **This design's perpendicular frontages** allows flexibility in the placement of the structure. It can go well with any of its four sides along a pathway, or conversely pathways along any or all of its four sides. Ideally, foot paths would border the courtyard area while roadways skirted the exterior of the building.

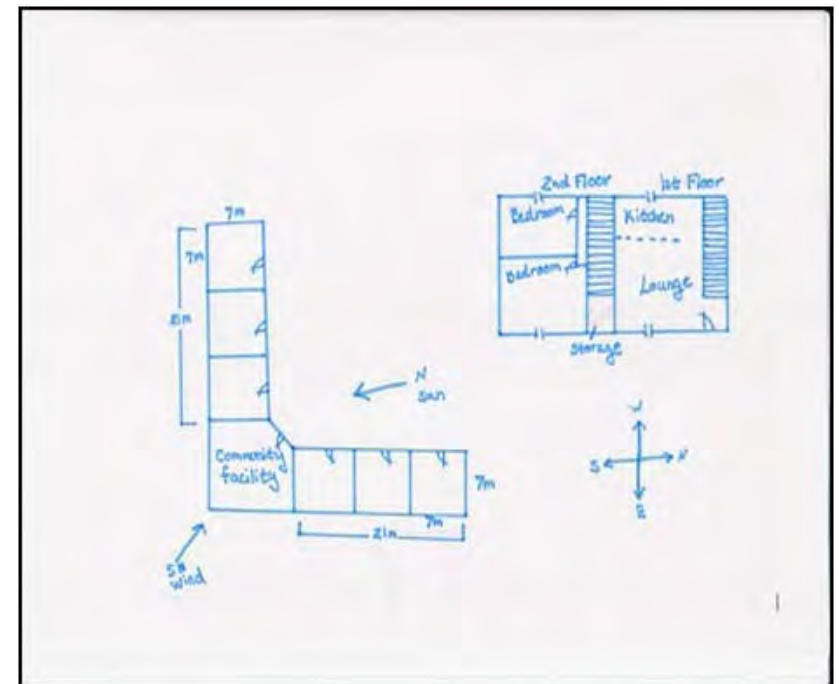

Design Cost

After finalizing some of our cluster designs, we were able to price out the cost of each one. The pricing is based on the amount the materials would cost according to Ecobeam pricing. Each cluster design was priced out by hand and broken down so that the pricing of different types of materials can be seen. For future planning, a detailed spreadsheet will be available to determine the pricing of different types of building structures using Ecobeam materials. Through our own pricing, it can be seen that the designs are similar in price. The overall building prices are similar, but the differences can be seen in the single unit price of each complex. The more area offered by the individual unit, the higher the price for that unit will be. This offers a variety to the community and will allow them to be able to build according to the available monetary support and land space.

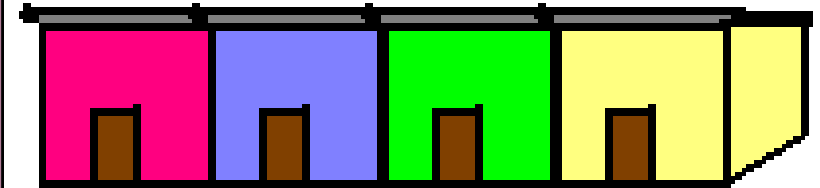

Crescent Design

Walls: R17/m

6 per 4m wall @ 2.4m high, 90cm spacing
7 per 5m wall @ 2.4m high, 90cm spacing
Total: R4250

Ceilings: R45/m

11 @ 4.5m long = R11250
5 x 4.5m x R45 = R1125/room + 8 x 210 = 5 X R2805 = R14025
Total: R25275

Plaster:

R1260 interior plaster/room $([3 \times 10m^2 + 12m^2] \times R30/m^2) = R6300$
R660 exterior plaster/room $([10m^2 + 12m^2] \times R30/m^2) = R3300$
R600 exterior plaster/story $([10m^2 \times 2] \times R30m^2) = R600$

Bags:

Total: R9350

Plywood:

8 sheets/room = 40 sheets X 230
Total: R9200

2 Story

2 x R75610 = R 151220
+ (2 x R11250 = R22500) + (2 x R9200 =
R18400)
+ R40900

Total: R192120

1 Story

Walls: R4250 Beams
R10200 Plaster
R9350 Bags
R14025 Ceiling

Total: R37805 x 2 = R75610

Simple Row House

Wall Studs (114) = R9690
Second Floor, 75 beams @ 10m = R33750
Flat Roof, 25 beams = R5625
Plywood (Floor), 53 boards = R12190
Plywood (Roof), 53 boards = R11130
Plaster (Outside + inside) = R24480
Internal Bags (375) = R20625
External Bags = R23265

Total: R140755

Individual Unit: R11730

Simple Row House (Double Story)

Beams:

Walls: 176 @ 2.4m = R14362
Floor: 72 @ 6m
72 @ 4m = R 32400
Roof: 24 @ 10m = R10800

Plywood:

@ 2.4m
Floor (21mm) = R22540
Roof (18mm) = R20580

Cladding:

Plaster = R 17700

Bags:

@ 300x300x80
55 bags/m² = R10340
@ 300x200x80 = R4708
Total: R30090

Total: 148477

Methodology

1. Charrette

In order to determine the current conditions of Monwabisi Park, we, the buildings team, visited four different shacks within the Park. We worked with co-researchers Yolisiile and Anele who brought us to the various structures. The co-researchers were able to explain to the residents why we were touring homes in the park. They were also able to make clear that we were not here to build them a new house, but rather to learn how they live now, and gather ideas so that in the future they may be able to improve upon their current living situations. The residents were very receptive to us

and our questions. Many even allowed us to take pictures of their homes.

After touring some homes throughout the Park we began the charrette process in order to get more feedback from the residents as well as other IQP teams on possible design ideas. Meetings were held between the different IQP groups and a few guidelines were given out for the individual presentation portion of the charrette. Each team was asked to make a 5-7 minute PowerPoint presentation and include questions or problems specific to their project to present to those in attendance. These questions would be kept

in mind as we moved into the discussion portion of the charrette. A handout was also made that displayed these questions and concerns along with the grouping assignments for each of the two breakout sessions.

The charrette was held on November 14, 2008, and began at approximately 10:30 am held at the Backpackers Lodge. After we introduced the charrette and the daily plans, the teams began their presentations. During the presentations it came to our attention that there were a lot of community members present who did not understand English. Nodumo, a co-researcher, offered to help translate and did so for each of the presentations. This was a great asset to the presentations because now we were assured that everyone in the room would be knowledgeable about our projects and research thus far.

After the presentations had concluded, everyone in attendance was split into eight groups. Four of those groups were to work on single house upgrading while the other four groups focused on designing a water facility. Each buildings team member took the lead for one of the single structure unit groups, while members of the water team led the water facility groups. For this breakout

session, the Street Committee spent time with the water facility design group. During this breakout session, all groups were to work on their designs for thirty minutes and then gather and discuss their models with their respective grouping (i.e. single house or water facility). From there, these groups would then to decide what im-



portant features came out of their smaller group discussions, and then present them to the other half of those attending the charrette. The Street Committee was very helpful during this process. We were able to determine which housing structure they liked the best and which would be most accepted into the community.

Once this first debriefing was concluded, everyone was again split into groups. This time we headed the four groups that would be designing the cluster housing, while the mapping team took over the macro-level development discussion groups. The same format was followed for the discussion and debriefing process

as during the first half of the charrette. Again, the Street Committee proved to be a great asset in the debriefing. They alerted us as to what would be useful and what would be unacceptable to build in their community. Even though the charrette did not go exactly as planned, we were still able to leave with a great deal of knowledge and a plan of where to take our project next. We now know what the street committee will accept, what they are looking for, and what got them excited about our designs. We also learned that keeping to a very structured plan will not always work within Monwabisi Park. The atmosphere there is much more laid back than we are used to when giving presentations and hosting discussions. We were able to accomplish everything we had hoped, but in a way that allowed everyone to participate to the extent they wanted. Facilitating this charrette taught us how to be flexible, and how to change plans according to what will work best for obtaining the information we need, as well as making those participating as comfortable as possible.

Not only did the charrette provide a lot of useful information but we decided to hold a meeting with architect Mike Shaw in order to get his feedback on the designs. He stressed the importance of designing for the person living in the building more so than for



Methodology

aesthetic purposes. He alerted us to the fact that the outside elements play a large role in designing a home, especially in the environment of which Monwabisi Park is situated. The high winds and beating sun must be considered during the design process. Insulation and water collection will play a major role. Simplicity was the key point of **Mike Shaw's meeting and we** should not try to incorporate too much technology into our designs. Understanding what the community wants and needs will be very beneficial to providing an acceptable design plan.

2. Backpacker's Lodge

Designing new buildings for Monwabisi Park is very important but there are existing structures that require our attention as well. The recently constructed backpackers lodge is almost complete and we had the opportunity to help with construction. Before getting started we took a walk around the building to get a sense of what the building was like. One major concern to us during our initial walkthrough was the support for the second floor. It was currently being held up with only a few beams. The floor of the second story sags greatly when someone walks across it. We needed to make sure that the second floor had the proper support.

Beams had already been delivered to the building but had

not yet been installed. The team first began to make boxes beneath the areas that needed support that will soon be filled with concrete. With the help of the builders we made sure that the boxes were in the appropriate location before the concrete was poured. The builders mixed the concrete for us and poured them into the wooden boxes. In order



for the concrete to provide the maximum strength for the wooden beams we needed to wait a day for it to dry. The following day we returned to find that the **concrete wasn't nearly dry** enough nor did it have the right composition to hold up the beams. We needed to start over

and make sure the next batch of concrete had the correct composition. Once we made sure it did we needed to remove the previously poured batch and replace it with the new concrete. Once again we needed to wait until the following day so the concrete would have enough time to dry. The next day we were eager to see if the concrete had dried to

the proper consistency. At first glance it looked good and with further inspection it was the right mixture and now we were ready to install the wooden beams. Unfortunately we do not have to proper training or experience to install these beams so we needed the help of Hank, one of

Ecobeam's employees. He is extremely knowledgeable in the construction field and knew exactly how to install the beams so they will provide the proper support for the structure. The builders as well as the team gathered up the beams from the Wendy house that needed to be installed. During the concrete pouring phase we made sure we placed a piece of rebar into the concrete so when we placed the beams it would have extra support. Placing the first beam was a bit of a challenge because we were not sure how the structure would react when we jacked it up. The builders placed a small wooden beam on top of the jack and carefully placed the top of the beam up against the structure and started jacking it up. The entire building started to crack and creek as it slowly moved upwards. After many cranks the structure was high enough the place the stronger beam in place. Before doing so we needed to make sure that a small square piece of wood was hammered into place on top of the beam to allow for more surface area for the structure to sit on. Once that was in place a small hole needed to be drilled into the bottom of the beam in order for it to properly rest on the rebar. Now the beam was ready to be put into place. The beam was carefully placed and aligned with the rebar and was hammered into place. Before removing the jack we needed to make sure the beam was in the



correct position and could take the weight of the second floor. The beam was in the correct position and we removed the jack, slowly letting the second floor come to rest on the beam. Now we needed to repeat the same procedure with 4 more beams. Three more beams were put into place but unfortunately the last beam could not be erected because the last horizontal beam was warping and needed to be realigned. In order to realign the beam we needed to take small pieces of wood and slowly



Methodology

wrench it back. Once it was in a straight line the final beam could be erected. The second floor now had the proper support. In order to make sure that the job was done correctly we walked up to the second floor to see if the floor still sagged when we walked across it. There was still a bit of sagging but the beams provided much more support than what was originally there.

When we did our initial

walkthrough of the backpackers lodge there were many things that needed to be cut at the Eco-beam factory and brought back to Monwabisi Park. One of the major components of the lodge that needed to be delivered were the railings that surround the two decks. In order to properly cut the railings to length we needed to first measure the perimeter of the two decks



was determined we could now go back to the Eco-beam factory and cut the railings and beams to length. With the help of our sponsor, Mike Tremeer, we found the proper pieces of wood at the Eco-beam factory. We measured out individual pieces that needed to be cut and used the table saw to cut all the pieces. Once the pieces were cut we needed to make sure that the edges of some of the beams were cut to a forty-five degree angle to account for the stairs. About half of the pieces needed to be cut. Once we were finished cutting the beams for the decks we needed to make pieces for the horizontal railings. We needed quite a few pieces in order to allow for the large outside spaces surrounding the backpackers lodge. Metal pieces were measured, cut, and molded to form the railings of the two decks. Pieces of metal that are used for ecofences will be used to create these railings. Once we measured out and cut the pieces of metal to length a large machine was used to shape the pieces of metal into smoother pieces to assure that no one will cut their hands while using the railings. Now that all beams and railings were cut they could be delivered to Monwabisi Park and installed.

3. Clinic

After walking around the new community center and the clinic there were many things

that we needed to accomplish. The first on our list consisted of putting up walls on the second floor of the new community center. In order to do this we needed the help of Oupa as well as Bembe. They showed us how to use the power tools and where



the walls were to be placed. Once we were sure of what we were doing we started cutting plywood and soon after we placed a few walls and formed a doorway that led to the first of five bedrooms. The builders finished off most of the walls. Soon after we came in and spackled the walls to assure for an even paint job. About halfway through the construction of the walls the builders ran out of materials. We needed to inform Mike Tremeer that the new material for the walls needed to be delivered soon otherwise the project would be delayed. The following day Mike Tremeer came with a truckload of materials to finish off the job. We helped unload the materials and carried them up to the second floor.

Another big concern to us was the second floor of the

youth center directly above the clinic. When walking across the second floor it greatly sagged. A beam had been put into place the previous year but was taken down because the proper bracket could not be located. That same beam had been sitting in the Wendy house for the past year.

We removed the beam from the house and talked to Mike Tremeer about what should be done to put this beam in place. All that was needed were a few pieces of wood to attach at both ends of the beam and nail into place. Once we attained these pieces they were nailed into place and the beam could now be erected. After about an hour our hard work paid off and the beam was resting nicely in place. In order to make sure that the work we did could hold the bracket in place we asked Hank to look at the beam. All that was needed were a few bolts and in order for the beam to be securely held in place. Once the beam was secure we walked up to the second floor to test out the new support. Surprisingly enough the floor sagged much less. We were all proud of the work we had accomplished in and around the clinic and hope to continue with similar projects around the Indlovu Center and in Monwabisi Park.

References

- A. Shaw, Mike. Interview. 12 November 2008
- B. Tremeer, Mike. Interview. 6 November 2008
- C. Womersley, Di. Interview. 10 December 2008
- D. Goven, G. (2007). *Green Urbanism - Kosovo informal settlement upgrade*. Cape Town, South Africa: ARG Design.
- E. Hinds, C., & Osman, A. (2005). *Housing Design, Urban design, and Multilayered Environments*. South Africa: Department of Architecture, University of Praetoria.
- F. Huchzermeyer, M. (2006). *The Struggle for In Situ Upgrading of Informal Settlements: Case Studies from Gauteng*.
- G. Karusseit, C., & Osman, A. (2008). Practice and Education: Housing and Urban Environments in South Africa. *Architects' Third Scientific Conference on Urban Housing in Sudan*, (pp. 15-17). Khartoum, Sudan.
- H. Lemmer, C., & Osman, A. (2005). Open Building Principles in South Africa: An Academic Exploration in Soshanguve, Praetoria. *Open House International* , 71-80.
- I. Mollison, B. (1981). *The Terrible Time of Day*. Retrieved September 14, 2008, from http://www.emissionzero.net/Introduction_to_Permaculture_-_Bill_Mollison_1981.pdf
- J. Osman, A., & Nzuzi, N. (2007). Levels of the Urban Fabric: Creating a More Sustainable Social Housing. *Housing and Urban Environments Research* .
- K. RoofHelper, (2008). Roof Types Roofing Style. Retrieved September 28, 2008, from RoofHelper Web site: <http://www.roofhelper.com/typesofroofs.htm>
- L. Lennert, B., & Leutzenhisler, A. (2003). *Charrettes 101: Dynamic Planning for Community Change*. Retrieved September 28, 2008, from National Charrette Institute: http://www.charretteinstitute.org/resources/BuildingBlocks4_1.pdf

Appendix A: Ecobeam Costing Spreadsheet

Inputs

Inputs	Value
House Dimension x (meters)	2
House Dimension y (meters)	3
Number of Stories	2
Height of Ceiling	2.4
Roof Pitch (degrees)	15

This is an example of a spreadsheet used to determine the cost of an Ecobeam structure. The first step is to input the dimensions of the house being designed as well as the roof pitch and the height of the ceilings. The next box gives the material costs for certain parts of the structure such as the floor

beams as well as the doors and windows. The labor for the entire structure is also taken into consideration for the final cost estimate. Once everything is inputted correctly into the spreadsheet an output box tells you the total cost of the structure. It also breaks the cost down into different categories.

	Cost
Walls	12546.66667
Flooring	675
Roofing	1661.61827
Windows/Doors	1600
Labor	1529.006476
Total	18012.29141

	Material Cost	Labor Cost
Wall Beams	906.6666667	35.55555556
Floor Beam (0m - 5m)	675	10
Floor Beam (5m - 7m)	0	0
Floor Beam (7m - 10m)	0	0
Floor Beam (10m+)	0	0
Ceiling Beam	232.9371406	3.450920601
Sandbags (exterior)	7080	1210
Sandbags (interior)	3840	0
Shutterboard	0	0
Plaster	720	240
Plywood (18mm)	0	0
Plywood (21mm)	1428.681129	0
Windows	800	0
Doors	800	0

Materials	Value (Rand)	Rate
Wooden Beam (380 x 380)	7	/ m
Wooden Beam (760 x 500)	35	/ m
Metal Lattice	10	/ m
Wall Spacing	0.9	m
Floor Spacing	0.4	m
Roof Spacing	1.2	m
Sandbags (300 x 200 x 80)	0.8	/ bag
Sandbags (300 x 300 x 80)	1	/ bag
Sand	400	/ m^3
Shutterboard	90	/ m^2
Plaster	30	/ m^2
Plywood (18mm)	210	/ sheet
Plywood (21mm)	230	/ sheet
Window	200	/ window
Door	400	/ door

Item	Amount	Rate
Wall Beams	53.33333333	m
Floor Beam (0m - 5m)	15	m
Floor Beam (5m - 7m)	0	m
Floor Beam (7m - 10m)	0	m
Floor Beam (10m+)	0	m
Ceiling Beam	5.176380902	m
Sandbags (exterior)	1320	bags
Sandbags (interior)	0	bags
Shutterboard	0	m^2
Plaster	24	m^2
Plywood (18mm)	0	sheets
Plywood (21mm)	6.211657082	sheets
Windows	4	windows
Doors	2	doors

Labor	Rate (rand per hour)	Work Rate	Rate	Cost / unit
Ecobeam Construction	10	15	m / hour	0.666666667
Bag Filling	10	40	bags / hour	0.25
Bag Sewing	10	15	bags / hour	0.666666667
Plastering	10	1	m^2 / hour	10
Sandbag Stacking	10	40	bags / hour	0.25
Framing	10	2	m^2 / hour	5

Appendix B: New Community Building Ground Floor

Clinic: **Description:** The clinic is opened to the entire Monwabisi community as a day hospital. A doctor is available from 7am to 4pm for any medical needs. Medicine is provided to the sick as well as any other medical supplies ^c.



Size: 12m x 12m
Occupancy: 50
Staffing: Doctors and nurses
Access needs: Access from main road
Amenities: Toilets in clinic
Equipment/supplies: Pharmacy supplies, Medical supplies, chairs, tables, exam room supplies
Storage: Storage for medical supplies
Security: Locks on doors at night

Community Hall: **Description:** The hall will have flexible space that the community can use for gatherings or other activities such as street committee meetings ^c.

Size: 9m x 12m, **Occupancy:** 50, **Access needs:** Access from main road, **Amenities:** Toilets nearby, **Equipment/supplies:** Chairs, tables

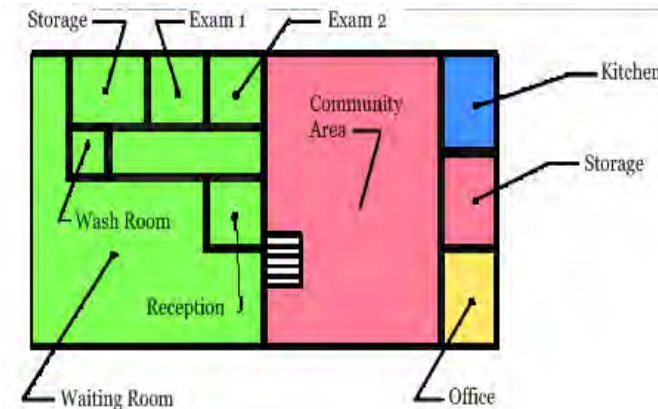

Kitchen: **Description:** Attached to back-packers lodge or restaurant to provide food to guests and provide training for the community members ^c.



Size— 3m x 4m
Hours — 11am-1pm
Staffing—Cooks
Amenities—Toilets nearby
Equipment/supplies—Equipment needed for cooking, seating area, food supplies
Storage—Separate room/ refrigerator to store food and cookware
Security—Locks on entrance to kitchen

Offices: **Description:** The office is used for managerial purposes, housing documents and providing information within the Indlovu Project area C.

Size: 3m x 4m, **Occupancy:** 5, **Access needs:** Access from main road, **Amenities:** Toilets nearby, **Equipment/supplies:** Office supplies



Appendix C: New Community Building First Floor

Youth

Description—The Youth Center is open for the children of Monwabisi Park after school hours. It is an area for them to gather, do homework, and have fun ^C.



Size— 7m x 10m

Occupancy— 40

Staffing— Counselor

Access needs— Access from main road

Amenities— Toilet nearby

Equipment/supplies— Pool Tables, Games, Television, Movies, Art Supplies

Learning

Description: To provide a space for community learning on all levels - childhood, adult, skills and trades. Residents can come late at night after work to learn a new trade or brush up on previous skills ^C.

Size: 5m x 12m, **Occupancy:** 30, **Staffing:** Teachers, **Access needs:** Access from main road, **Amenities:** toilets nearby, **Equipment/supplies:** Desks

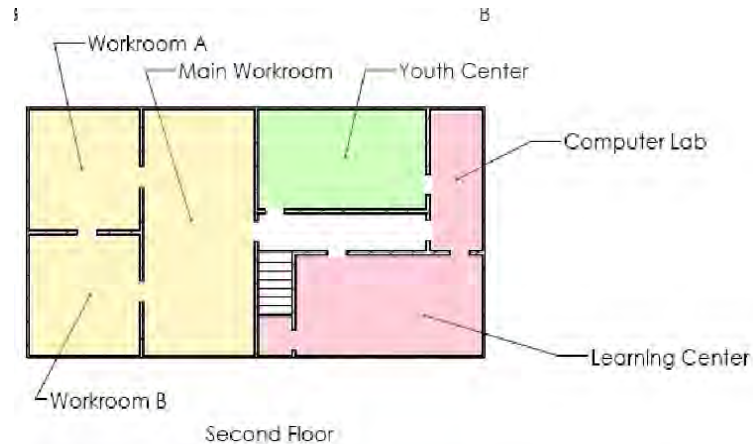
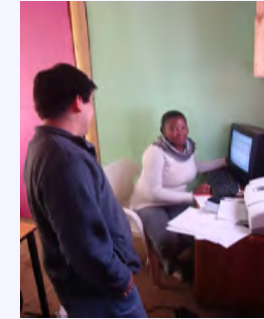

Work-

Description— To provide a space for production of textiles as well as an area for artisans to work and train others in the trade of carpentry ^C.

Size: 6m x 6m, **Occupancy:** 10, **Staffing:** Teachers/instructors, **Amenities:** Toilets nearby, **Equipment/supplies:** Multiple sets of woodworking tools as well as stationary tools



Appendix D: Indlovu Project - Immediate Phase

Crèche

Description—The crèche serves as a place for children as young as 6 months to be cared for during the day. Not only are they cared for during the day but educational services are also offered. This building also offers preschool services ^c.



Size: 6m x 9m, 80m²

Occupancy: 40

Hours : 8am-3pm

Staffing: Teachers

Equipment/ supplies: Educational supplies, desks, blankets, tables, chairs

Storage: Areas to keep toys and educational tools

Security: Locks on doors at night

Guest House

Description—Provide lodging for backpackers and provide income for the Shaster Foundation as well as the Indlovu Project ^c.

Size: 6m x 9m, **Occupancy:** 20, **Hours:** 24 hours,

Equipment/supplies: Bedding, bathroom and shower equipment, **Storage:** dressers and bins for overnight guests

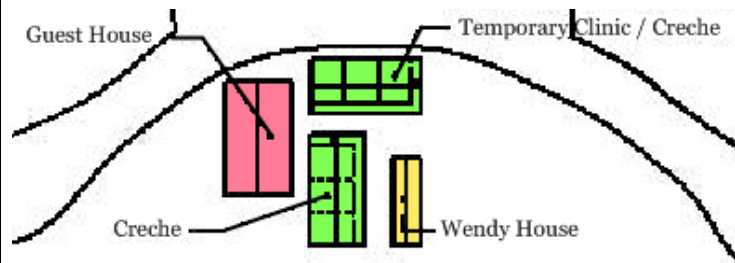

Wendy House

Description— The Wendy house can be utilized for storage or other various activities. It can be used for a small night classroom for adults or a small workshop for handiwork such as sewing or doll making ^c.

Size: 3m x 9m, **Occupancy:** 20, **Hours:** 24 hours,

Equipment/supplies: Storage areas for supplies

