



Designing a Culvert Management System for the Town of Spencer, MA

A Major Qualifying Project

Submitted to the Faculty of

Worcester Polytechnic Institute

In partial fulfillment of the requirements for the

Degree of Bachelor of Science

In Civil Engineering by:

Ryan Bagge

Seamus Gallagher

Kevin Galvin

Approved:

Professor Suzanne Le Page, Advisor

Date: March 26, 2015

Abstract

Twenty-two road-stream crossings were assessed for the Town of Spencer, MA and the River and Stream Continuity Database. Each culvert, bridge, or dam was profiled to identify any constraints and possible considerations for future maintenance or replacement. A structural module was designed to assess the current condition of the crossings and work alongside the River and Stream Continuity Project, which does not have a structural component. The resulting analysis was presented to the attention of the Spencer Water Department.

Acknowledgements

The project team would like to thank everyone who provided insight and support throughout the duration of this MQP. A special thanks to our project advisor Professor Suzanne Le Page who guided the process and provided the team with valuable resources and advice. We would also like to thank Professor Leonard Albano who assisted in the development of the structural assessment.

A special thanks to Steve Tyler, project liaison in Spencer, who helped develop the project's scope and direction. He made sure the team had the necessary materials and safety precautions to perform the field work, even if that required working on a few weekends.

Thanks to Professor Scott Jackson, creator of the River and Stream Continuity Project, for training the team in his project's methods and allowing us to contribute to his database. This added great value and purpose to the MQP.

Finally, thanks to members of the Central Massachusetts Regional Planning Commission, who were always open and timely with sharing information on the Rt. 31 Corridor of Spencer.

Authorship

All group members contributed equally in the completion of this Major Qualifying Project. Field work was completed by all members of the team. The table below displays how each section of the report was divided. Editing was performed by all members.

Section	Contributors
Abstract	Seamus
Capstone Design	Kevin
Professional Licensure	Kevin
Introduction	Seamus
Background	Kevin and Seamus
Methodology	All members
Structural Assessment Design	Ryan
Culvert Profiles	All members
Conclusion	Seamus

These signatures indicate the acceptance of what is stated above:

Ryan Bagge

Ryan Bagge

Seamus Gallagher

Seamus Gallagher

Kevin Galvin

Kevin Galvin

Capstone Design Experience Statement

To meet the requirements put forth by the Accreditation Board for Engineering and Technology (ABET) this Major Qualifying Project (MQP) culminated in a design portion that incorporated engineering standards and realistic constraints. This section will provide a description of the design problem, the team's approach to the problem, and how ABET General Criterion's realistic constraints were addressed.

Design Problem

Assessing infrastructure is a responsibility held by the government at the local, state, and federal level. It is a critical duty that requires collaboration of information and methods between agencies. The Town of Spencer recognized a need to expand the existing inventory of the Town's infrastructure, specifically their culverts. The Town also recognized an interest in becoming involved in the River and Stream Continuity Project (RSCP) that is gaining recognition throughout the eastern United States. The RSCP is an assessment procedure and database that mainly focuses on the environmental impact of road-stream crossings, but the Town of Spencer also recognized the importance of including a structural assessment for culverts. This MQP team was tasked with designing such an assessment and providing recommendations to the Town.

Approach

To solve this problem, the team was first trained on the methods of the River and Stream Continuity Project. Once trained, aquatic assessments were performed at each of the twenty-two culverts included in this project and uploaded to the RSCP's database. The team

then began to design a structural assessment for culverts that would produce a score from 0-1, to accompany the aquatic score already acquired. The design involved extensive research into how transportation agencies manage their culvert and crossing systems. Through researching best practices and meeting with Professor Albano, a Structural Engineering Professor at WPI, the team decided on thirteen characteristics to be graded during a culvert structural assessment. Furthermore, four categories were deemed critical to structural integrity and were displayed with a different marking than the other categories. The final structural assessment form is accompanied with a packet that includes pictures depicting what each score looks like for a certain category.

To provide recommendations to the Town of Spencer, the team designed a culvert profile for each of the culverts assessed that encompassed any relevant information that had been acquired during the project. The profile includes the aquatic and structural score, field notes and dimensions, and traffic data. Using this information, the team provided a short and long term recommendation for each culvert. Infill needed to replace the culvert was also included to give the Town an estimate of how extensive a replacement project would be. These profiles provide the Town of Spencer with one easy-to-read document reviewing twenty-two culverts within the Town's jurisdiction.

Realistic Constraints

According to ABET General Criterion, realistic constraints must be addressed in a capstone design experience. "These constraints will include most of the following considerations: economic; environmental; sustainability; constructability; ethical; health and

safety; social; and political”. This section will provide a brief description on how each of these considerations were addressed during this MQP.

Economic

This project culminated in short and long term recommendations provided to the Town of Spencer. Cost was a factor while determining these recommendations. Short term recommendations were mainly low-cost tasks that the Town could perform over the next six months. Long term suggestions were more in depth replacements in which the Town would have time to acquire the necessary funding. By providing the infill volume required to replace culvert, the team also provides the Town with an estimate of how large projects would be.

Environmental

An emerging component in culvert and stream crossing design is how they affect the surrounding environment. Stream Continuity Groups have started a push for culvert design that considers how the crossing could affect aquatic life and the hydrology of the stream. These factors were considered during the project and impacted the final recommendations. Also, by participating in the River and Stream Continuity Project the team has helped expand an effort to preserve aquatic ecosystems.

Sustainability

Sustainability clearly plays a huge part in the design of any type of infrastructure. Designs need to be able to hold through storms, handle high water flow periods, and maintain a good driving surface for vehicles. The team’s recommendations factored which options would provide the Town with sustainable road crossings as well as aquatic ecosystems. Proper

diligence when analyzing the ecological conditions also improved the chance of sustaining the populations of the aquatic life that interact with the crossings.

Constructability

To address the constructability of each culvert recommendation, the team factored in traffic information, future plans for the road, and the infill volume required for construction. The effect construction would have on commuters and members of the community was also considered. These factors provide a good glimpse of how constructible replacing one of the culverts would be.

Ethical

The American Society of Civil Engineers (ASCE) Code of Ethics were abided by during the completion of this Major Qualifying Project. The Code states that “engineers shall hold paramount the safety, health and welfare of the public; perform services only in areas of their competence; act in such a manner as to uphold and enhance the honor, integrity, and dignity of the engineering profession and shall act with zero-tolerance for bribery, fraud, and corruption” (“Code of Ethics”²). This Code was followed throughout this project with the intention of providing the Town of Spencer with the best recommendations that will promote public safety and enhance the infrastructure in Spencer.

Health and Safety

The team was aware of health and safety throughout the project’s duration. While performing field work in Spencer, the team wore yellow construction vests to preserve the safety of ourselves and passing motorists. The structural assessment was designed to provide

the Town and any observers with an accurate score of the integrity of the culvert. Scoring culverts can make agencies aware of problems before they become detrimental to the health and safety of the public.

Social and Political

During this project, the team worked alongside the Town of Spencer in developing short and long term recommendations for culverts. Socially this will affect the residents of the Town if any recommendations are deemed necessary and ready for construction. The political aspect was involved when addressing where the funding for a construction project will come from. The Town's government will need to be involved when budgeting any improvement decided upon.

Professional Licensure Statement

Becoming a Professional Engineer (PE) in the Civil and Environmental Engineering field allows for a higher level of responsibility and garners respect. The PE license grants authority to sign and seal engineering plans and apply for high-level government positions. It is a quality assurance measure used to promote the safety and well-being of the public.

Obtaining licensure requires a four year degree from an accredited engineering program and passing the Fundamentals of Engineering (FE) exam. This is followed by four years of field experience under a PE, concluded with passing the Principles and Practice of Engineering exam.

A Professional Engineer is considered to have a high standard of ethics and quality assurance. This is important because a PE is responsible for their own work, but also for the lives that are affected by their work. PE's are required to continually maintain and improve their skills, promoting quality and advancement in the industry. Acquiring a PE is an important step for the individual and for the safety of the public.

Contents

Abstract.....	ii
Acknowledgements.....	iii
Authorship	iv
Capstone Design Experience Statement.....	v
Design Problem.....	v
Approach.....	v
Realistic Constraints.....	vi
Economic	vii
Environmental.....	vii
Sustainability.....	vii
Constructability.....	viii
Ethical	viii
Health and Safety.....	viii
Social and Political	ix
Professional Licensure Statement	x
Table of Figures.....	xiv
Table of Tables	xiv
1.0 Introduction	1
2.0 Background	4
2.1 Types of Culverts.....	5
2.2 Common Problems with Culverts	9
2.3 Inventory Procedures.....	11
2.4 Existing Inventories in Spencer	13
2.5 River and Stream Continuity Project.....	14
2.5.1 Environmental Crossing Problems.....	16
2.5.2 Environmental Significance.....	18
3.0 Methodology.....	19
3.1 Scope Development	19
3.2 GPS Mapping.....	23
3.3 River and Stream Continuity Project Training.....	23
3.3.1 Road-Stream Crossing Inventory	24

3.4 Structural Assessment Design.....	25
3.5 Culvert Profiles.....	28
3.5.1 Field Observations and Notes.....	28
3.5.2 Improvement Considerations.....	29
3.5.3 GIS Maps and Impact.....	30
3.6 Project Deliverables	33
4.0 Results and Recommendations	34
4.1 GPS Mapping	34
4.2 River and Stream Continuity Project	36
4.3 Structural Assessment Design	40
4.3.1 Invert Deterioration.....	40
4.3.2 Joints & Seams	41
4.3.3 Cracking	42
4.3.4 Headwall/Wingwall.....	43
4.3.5 Apron	44
4.3.6 Pipe Damage.....	44
4.3.7 Scour	45
4.3.8 Cross-section deformation	46
4.3.9 Longitudinal alignment.....	46
4.3.10 Footing.....	47
4.3.11 Roadway over Culvert	48
4.3.12 Blockage at Inlet.....	49
4.3.13 Embankment.....	49
4.4 Structural Assessment Testing	50
4.5 Culvert Profiles	53
5.0 Conclusion	98
5.1 Limitations	98
5.2 Future Research: River and Stream Continuity Project	98
5.3 Town of Spencer: Environment and Community.....	99
Bibliography	101
Appendix A: Project Proposal	
Appendix B: CMRPC Route 31 Corridor Profile	

Appendix C: River and Stream Continuity Project Instruction Guide

Appendix D: Structural Condition Assessment for Culverts

Appendix E: Infill Calculations

Appendix F: Instructions for Viewing Results on River and Stream Continuity Database

Appendix G: Structural Assessment Field Data Form

Table of Figures

Figure 1: Rochester Bridge in Vermont.....	1
Figure 2: Map depicting relationship between Spencer roadways and the Chicopee Watershed	2
Figure 3: Culvert Diagram	4
Figure 4: Corrugated Metal Pipe Culvert (Photo: Ryan Bagge, 2014).....	5
Figure 5: Concrete Pipe Culvert (Photo: Ryan Bagge, 2014).....	6
Figure 6: Double-Pipe Culvert (Photo: Ryan Bagge, 2014)	7
Figure 7: Stone Masonry Embedded Culvert (Photo: Ryan Bagge, 2014)	8
Figure 8: Open-Bottom Box Culvert (Photo: Ryan Bagge, 2014)	9
Figure 9: Pre-cast Box Culvert (Photo: Ryan Bagge, 2014)	9
Figure 10: Work Options for Different Culvert Maintenance Strategies	12
Figure 11: Geographic Scope (highlighted route)	22
Figure 12: Replacement Materials Rank	30
Figure 13 - Traffic Data in Spencer.....	31
Figure 14: CMRSWC GPS mapping.....	35
Figure 15: River and Stream Continuity Project field data form.....	38
Figure 16: RSCP Aquatic Scores with Key.....	39
Figure 17: Culvert with Invert Diagram.....	40
Figure 18: Completed Structural Assessment Form example.....	51

Table of Tables

Table 1: Common Problems with Culverts.....	10
Table 2: Environmental Crossing Problems	17
Table 3: Culvert Type per Road.....	21
Table 4: Structural Assessment Field Data Form	27
Table 5: Invert Deterioration Condition Descriptions.....	41
Table 6: Joints and Seams Condition Descriptions	42
Table 7: Cracking Types for Different Materials	42
Table 8: Cracking Condition Descriptions	43
Table 9: Apron Condition Descriptions	44
Table 10: Pipe Damage Condition Descriptions.....	45
Table 11: Scour Condition Descriptions.....	46
Table 12: Longitudinal Alignment Condition Descriptions	47
Table 13: Footing Condition Descriptions.....	48
Table 14: Roadway Condition Descriptions	49
Table 15: Blockage at Inlet Condition Descriptions	49
Table 16: Embankment Condition Descriptions	50
Table 17: Structural Assessment Test Results	52

1.0 Introduction

As communities and populations grow throughout the Northeast so does the need to replace the aging infrastructure. The threat of failing infrastructure is expected to increase. Rising sea levels bring the possibility of more inland storms. Increased water levels and extreme precipitation acting together have the undoubted ability to ruin roadway infrastructure primarily at their points of crossing. The potential destruction was seen in several cases since the beginning of the 21st century.

The impacts of Hurricane Irene throughout the State of Vermont in August of 2011 were tremendous and daunting simply because of the vast area of destruction. Rivers and streams grew, after 7" of rain in some places, unproportioned to any infrastructure in place. 225



Figure 1: Rochester Bridge in Vermont

municipalities across the state were affected by the damage of the storm. Over 2,000 segments of roads were closed because of the surging watershed. Over 200 bridges and 960 culverts were affected or in some cases completely washed away, making the sum of total damages about \$250 million. Another \$21 million of damage was caused to railroad systems crossing swelling waters ("Tropical Storm Irene by the Numbers"). The extent of the damage left several municipalities stranded without any passable roads in or out of the towns.

The sheer amount of damage caused by the storm on the river and stream crossings raises concern. The mobility of citizens in the Northeast could be affected at a much higher rate with consistent storms of this magnitude. Similar to Vermont, Massachusetts has a variety of infrastructure ranging in age and integrity. The overall grade of Massachusetts infrastructure reported by the ASCE in 2009 was a D in comparison to Vermont, which received a grade of C. Massachusetts has budgeted a potential \$18 billion to address stormwater concerns, \$3 billion in its Accelerated Bridge Program, and another \$1 billion annually for road and bridge construction (“Action Steps for Improved Infrastructure in Massachusetts” 3).

The importance of understanding the ways our infrastructure interacts with rivers and streams can potentially save failing structures, aquatic ecosystems, and emergency management funds. Necessity for infrastructure to address all potential impacts, both positive and negative, becomes apparent in the midst of the growing opportunities to reconstruct in the nation.

This attitude is shared by many municipalities including the Town of Spencer, Massachusetts. Working alongside P.E. Steven J. Tyler of the Town’s Water Department, this project focused on how Spencer’s infrastructure, specifically culverts, interact with the regional watersheds. Collaborating with the Central

Massachusetts Regional Planning Commission and Professor Scott Jackson, founder of the River and Stream Continuity Project, this project compiled previous research and gathered field data,

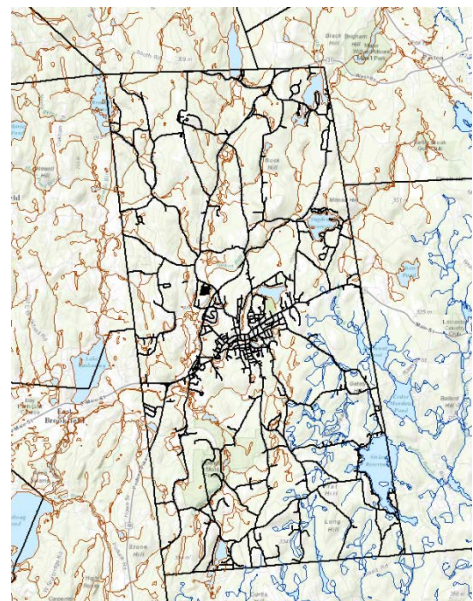

Figure 2: Map depicting relationship between Spencer roadways (black) and the Chicopee Watershed (brown)

to provide the Town of Spencer with an overview of twenty-two culverts in their jurisdiction. Along with short and long term recommendations for each culvert, the team also designed a convenient structural assessment field data form to assist in the continual task of evaluating inventory.

2.0 Background

The scope of this project included assessing several different types of culverts with a range of sizes and materials. A culvert is defined as “an opening through an embankment for the conveyance of water by mean of pipe or an enclosed channel” (“Culvert Types”). It is also important to note that any crossing longer than twenty feet wide is characterized as a bridge. This limit makes distinguishing between a culvert and a bridge straightforward (“Culvert Repair Practices Manual” 1-5). A basic diagram created by Purdue University’s Engineering Department depicts the components of a common culvert.

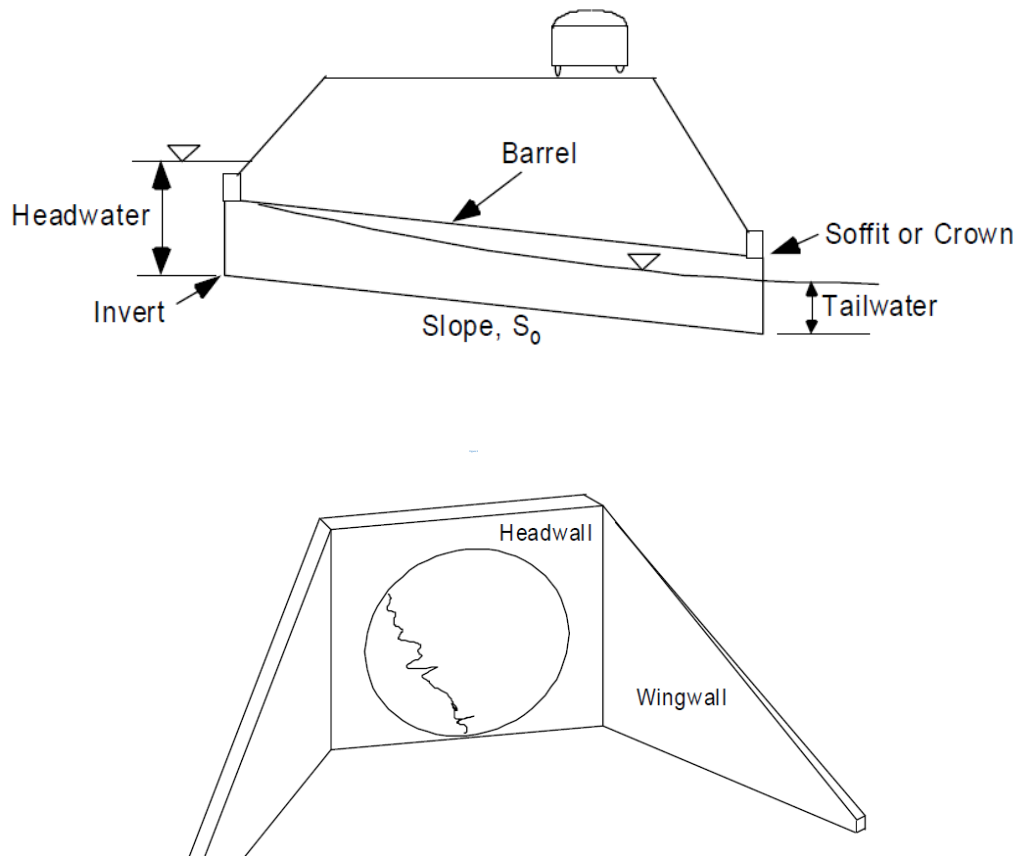

Figure 3: Culvert Diagram

2.1 Types of Culverts

One type of culvert the team assessed was a single pipe culvert. This type of culvert can be made from corrugated metal as well as pre-cast or cast-in-place concrete. Pipe culverts tend to be the cheapest option and therefore the most common but can lead to issues including hydraulic jumps and erosion of embankments during high flow periods. A hydraulic jump is defined as “the rise in water level, which occurs during the transformation of the unstable “rapid” or supercritical flow to the stable “tranquil” or subcritical flow” (Tuan 76). These types of jumps create unnatural environments for wildlife and can endanger their habitats as well as prevent erosion concerns. Pipe culverts also can be more prone to clogging due to the “diminishing free surface as the pipe fills beyond the midpoint” (“Culvert Repair Practices Manual” 2-17). Examples of a corrugated metal and concrete pipe in Spencer can be seen below in Figures 4 and 5.



Figure 4: Corrugated Metal Pipe Culvert (Photo: Ryan Bagge, 2014)



Figure 5: Concrete Pipe Culvert (Photo: Ryan Bagge, 2014)

Another type of culvert the team added to the inventory was a double pipe culvert. These culverts can also be made out of corrugated metal or pre-cast and cast-in-place concrete. Multiple pipes or multicell culverts can be used to obtain the necessary hydraulic capacity for wide waterways and low embankments (“Culvert Repair Practices Manual” 2-18). Numerous studies have been conducted on the effectiveness of multicell versus single cell culverts. Multicell culverts have been recommended “as a best management practice to minimize erosion and improve fish passage” (Wargo, Weisman 1), however other problems can still arise. An example of a concrete double-pipe in Spencer can be seen in Figure 6:



Figure 6: Double-Pipe Culvert (Photo: Ryan Bagge, 2014)

The scope of this project also included several older culverts along South Spencer Road. When examining older culverts, embedded stone passages are often found. These small stone crossings usually support intermittent streams that collect runoff during storm events. While these crossings can be constricting to wildlife passage, they are durable and usually low maintenance (“Culvert Repair Practices Manual” 2-18). An example of an embedded stone culvert is pictured in Figure 7:



Figure 7: Stone Masonry Embedded Culvert (Photo: Ryan Bagge, 2014)

The last type of culverts examined for this project were box and open-bottom box culverts. Open-bottom box culverts carry a similar appearance to bridges and share many hydraulic and structural characteristics. Besides the length limit (20 feet), they are essentially bridges. Pre-cast box culverts are slightly different; shaped as a complete rectangle. Comparable substrate to the stream bed can be placed on the pre-cast flooring to give the crossing a natural feel, benefiting wildlife. Box culverts can be made in many different sizes however the angular corners reduce the structural and hydraulic efficiency compared to other culvert shapes (“Culvert Repair Practices Manual” 2-18). Pictures of an open-bottom and box culvert are shown in Figures 8 and 9.



Figure 8: Open-Bottom Box Culvert (Photo: Ryan Bagge, 2014)



Figure 9: Pre-cast Box Culvert (Photo: Ryan Bagge, 2014)

2.2 Common Problems with Culverts

During their service life, culverts can experience a variety of problems, each unique to the field conditions. These problems can generally be classified into two categories; serviceability and strength related issues. The Federal Highway Administration produced a Culvert Repairs Practices Manual in 1995 that listed these problems. These problems coupled with a brief description are presented in Table 1:

Table 1: Common Problems with Culverts

Scour and Erosion	Problem culverts often experience scouring at the inlet and/or outlet. Water can wash away stream banks and eventually erode the fill around the culvert. Outlet scouring can also cause undercutting of stream banks or wingwalls and create barriers for aquatic wildlife passage ¹ .
Inadequate flow capacity	This describes culverts that are not big enough or constructed properly to handle the flow of the stream. This often leads to flooding or the washing-out of a culvert.
Corrosion of metal culverts	Corrosion is mainly a concern in areas with a low pH or where drainage originates in bogs and swamps. A corroded pipe can lead to much bigger problems over time such as a crossing collapse ¹ . Corrosion can also affect the reinforcing steel placed within concrete.
Deterioration of concrete	Similar to corrosion in metal pipes, deterioration of concrete culverts can lead to structural integrity concerns.
Sedimentation and blockage by debris	A very common problem that can usually be fixed by routine maintenance. A blocked culvert will deter the water in other directions leading to erosion and possible wash-outs.

Strength-Related Problems

Cracking	Cracking in culverts can occur for a number of reasons. Movement of soil surrounding the culvert can change how the stress is loaded and lead to a crack. Once cracked, a culvert’s capacity to support loads is reduced and it becomes a safety problem ² .
Undermining and loss of structural support	Undermining generally affects the headwalls, wingwalls, and apron of a culvert. These parts of a culvert add structural support and help fight erosion at the inlet and outlet. Water undermining these points reduces their capacity to support soil.
Loss of the invert of culverts	Invert loss references the deterioration of the bottom portion of the culvert as well as the flattening of that section due to excess loading. Deterioration can be a significant problem as loads applied to the culvert begin changing. The flattening of an invert is not as serious but could indicate distress ² .
Shape-deformation	A deformed shape indicates that the existing conditions have been changing. Movement in the soil surrounding a culvert is typically designed for, making shape change a difficult problem to characterize. It is hard to determine if the shape change is a problem or just part of the anticipated movement. More in depth field work is necessary for this issue ² .

¹"Culverts — Proper Use and Installation." *Wisconsin Transportation Bulletin No. 15* (2004): n. pag. Web. 10 Feb. 2015.

² *Culvert Repair Practices Manual*. McLean, VA: U.S. Dept. of Transportation, Federal Highway Administration, Research and Development, Turner-Fairbank Highway Research Center, 1995. Web.

While most problems associated with culverts fall under the serviceability or strength related categories, a focus on environmental impacts has emerged over the last decade. These environmental problems and projects being developed to address them will be discussed in Section 2.5 of this report.

2.3 Inventory Procedures

Stream crossings under roadways require inspection and maintenance to ensure safety for the public. Different agencies have used different procedures when performing culvert assessments but essentially the same characteristics are documented. This section will discuss the inventory methods of transportation agencies as well as the Town of Spencer's methods.

Transportation agencies of all levels have to deal with the maintenance and rehabilitation of pipes and culverts. Whether it is on the local, state, or federal level, agencies should have plans in place to handle culvert inspection and ensure the safety of the public. Realizing that there is no universal method to running these programs, the National Cooperative Highway Research Program conducted a research project in 2002 titled the "Assessment and Rehabilitation of Existing Culverts". The result was a study that presents "what management systems and methods are being used by transportation agencies to predict the service life of pipes" (Delaney 7). The study found that State DOT's had pipe assessment programs that ranged from none to a system that included a central database. MaineDOT initiated one of the more advanced programs. The agency created a database that would become their main data source for a transportation management system and allow maintenance personnel to be more "proactive, rather than reactive, in their pipe management program" (Delaney 8). A common need among transportation agencies is the need for a system

that promotes repair before accidents occur. Once a problem is recognized, there are typically several different solutions that can be implemented. In Ballinger and Drake’s *Culvert Repair Practices Manual*, a table breaks down these strategies and possible work options:

WORK OPTIONS FOR DIFFERENT PIPE STRATEGIES (Ballinger and Drake 1995)

Strategy	Objective	Work Options
Routine Maintenance	To keep a culvert in a uniform and safe condition by repairing specific defects as they occur.	<ul style="list-style-type: none"> • Debris and sediment removal • Thawing frozen culverts
Preventive Maintenance	A more extensive strategy than routine maintenance, intended to arrest light deterioration and prevent progressive deterioration.	<ul style="list-style-type: none"> • Joint Sealing • Concrete patching • Mortar repair • Invert paving • Scour prevention • Ditch cleaning and repair
Rehabilitation	Takes maximum advantage of the remaining unusable structure in a culvert to build a reconditioned culvert.	<ul style="list-style-type: none"> • Repair of basically sound endwalls and wingwalls • Invert paving • Repair of scour • Slope stabilization • Streambed paving • Addition of apron or cutoff wall • Improving inlet configuration • Installing debris collector
Upgrade to Equal Replacement	Upgrade to provide service that is equal to that provided by a new structure.	<ul style="list-style-type: none"> • Addition, repair, or replacement of appurtenant structures • Lining of the barrel • Provision of safety grates or safety barriers • Lengthening of the culvert
Replacement	Provide a completely new culvert with a new service life.	Can be accompanied by: <ul style="list-style-type: none"> • Realignment • Hydraulic structural and safety improvements • Change in culvert shape or material

Figure 10: Work Options for Different Culvert Maintenance Strategies

The Federal Highway Administration (FHWA) designed a Culvert Management System (CMS) in the early 2000’s under the Local Technical Assistance Program. Many agencies already performed some of the functions provided by the CMS. However, the new program gathered all the functions already in use and formalized and automated them (“Asset Management” 1). Once the key features were determined, FHWA created five modules that could be used by agencies as part of a software program. The modules were inventory, condition, maintenance

and repair, work funding, and schedule (“Asset Management” 2). The CMS provided municipalities with a means of tracking conditions of their culverts, determining when maintenance was needed, and assistance in funding and scheduling repair work. However, the NCHRP study found through a questionnaire that not many of the agencies used this program in their work (Delaney 10). Although it may not have been widely used, the concepts used in the CMS program are used by every agency in one way or another.

2.4 Existing Inventories in Spencer

The Town of Spencer alongside MassDOT performs routine inspections of bridges and some culverts in the Town. Four bridges within the geographic scope of this project were assessed in May of 2012; two on North Spencer Road (Rt. 31), one on West Main Street (Rt. 9), and one on South Spencer Road. These assessments were completed following the National Bridge Inspection Standards (NBIS). Their inventory criterion consists of a rating system for the deck, superstructure, substructure, an AASHTO rating of the pavement, and other general information about the bridge. These ratings allow for a quick ranking of which crossings need the most work and which are suitable for the time being.

Another database associated with the Town’s infrastructure is run by the Central Massachusetts Regional Stormwater Coalition (CMRSWC). This Coalition was formed in the early 2000’s and now includes thirty towns in the region. These towns share stormwater systems and surface water resources. Collaborating allows the towns to protect the resources they share and meet the requirements of stormwater pollution permits in an efficient and cost-effective manner (“Who We Are”). The Coalition uses an online GIS-based system that contains geographically-referenced roadway, outfall, and catch basin information. Member towns are

able to use a Leica GPS device that will upload the coordinates and field information from point locations directly to the database. While Spencer has mapped a significant amount of the Town's outfalls and catch basins, a few roads were not yet mapped.

The Central Massachusetts Regional Planning Commission (CMRPC) has also performed an inventory of the crossings in Spencer on North Spencer Rd. (Rt. 31) and Meadow Rd. as part of an ongoing study of the Rt. 31 Corridor. CMRPC assists local municipalities in developing plans for transportation maintenance while accounting for safety and environmental impacts ("Transportation" 1). Their inventory includes a GIS mapping of the crossings and a field data sheet containing the following information: pipe size and length, type of material, condition of the pipe, and a field observations section. Their final report will include pictures of the culverts and bridges as well as recommendations for moving forward.

2.5 River and Stream Continuity Project

Culverts and bridges influence streams and rivers in two primary ways. The first impact allows easy passage for public vehicle traffic to cross over tough terrain and waterways. The second impact is the creation of barriers and obstacles through previously natural environments. Streams and rivers provide more than just a channel for fish to travel. These systems are continually evolving habitats without the impediments of crossings. Forced unnatural changes, like crossing infrastructure, can lead to negative development of habitats. The River and Stream Continuity Project (RSCP) has worked tirelessly to impose on this second influence.

According to the River and Stream Continuity Project, the crossings in the Northeast need progressive resolutions as soon as permitted to address the effects on ecological habitats.

Since the project's commencement in 2000, it has compiled extensive information, including requirements, standards, and methods addressing this issue. Professor Scott Jackson, an Environmentalist at UMass Amherst, originally modeled the project after similar efforts in the Northwestern US where support to migrating anadromous fish populations was vital to the economic stability of the region. With the help of the Massachusetts Division of Ecological Restoration – Riverways Program and the Nature Conservancy, Mr. Jackson created the Massachusetts River and Stream Crossing Standards. Much of this information was never mandated or regulated at a state level. The efforts of the River and Stream Continuity Project attempted to fill this void with a database in which volunteers inventory crossings.

The partnership, with the use of the database, addresses and in many cases advises municipalities in their ecological standards to reform the way culverts are rehabilitated and reconstructed. With the help of a Continuity Advisory Committee, including departments such as the Massachusetts Department of Transportation (MassDOT), Department of Environmental Protection (DEP), Fish and Wildlife Service (FWS), and several other contributors, these standards are being implemented on a broader scope across northeast America ("River and Stream Continuity Project"). By the fall of 2014, the project had assessed over 7,000 stream and river crossings throughout the Northeast. The information includes obstacles for wildlife passages, culvert designs, evaluating barriers to wildlife passages, and field protocol.

The record of each crossing is given a crossing code, aquatic score, and a terrestrial passage score. The crossing code is established by combining the latitude and longitude of the crossing preceded by the letters xy (e.g. xy4171264870890781). An aquatic score is developed through a scoring algorithm that uses the field data and dimensions of a crossing to produce a

score ranging from 1.0 (full passage) to 0 (no passage). The terrestrial passage score also uses a scoring algorithm to represent how suitable the crossing is for terrestrial wildlife (“River and Stream Continuity Project”).

The inventory creates approaches towards prioritizing the replacement of road-stream crossings. Reviewing and comparing stream and river crossings on a large scale with this efficiency can greatly impact the effects of infrastructure on wildlife and river health.

2.5.1 Environmental Crossing Problems

The River and Stream Continuity Project identifies several crossing problems that impact ecological passage. These are shown in Table 2:

Table 2: Environmental Crossing Problems

Inlet and Outlet Drop

Hydraulic jumps	Sudden drops in elevation represent physical barriers to most species.
Outlet pools	Create insufficient depth hindering fish from jumping into crossing from pool.
Piping and scouring	Divert stream paths and can completely block any passage for wildlife.

Physical Barriers

Debris	Barriers include natural debris and litter. Obstructions can block water and wildlife passage at inlet.
Beavers	Unnatural structures enclosing streams can encourage beavers to dam any source of flow.

Excessive Velocities

Seasonal flooding	Create velocities sometimes dangerous to fish moving downstream towards a crossing inlet. Flows reaching 10 feet per second are twice as strong as even the most capable salmonid can swim in.
Turbulence	Pipes with insufficient area for flow create instability in the habitat disorienting fish and wildlife in surges of unpredictable flow.
Resting areas	High flow takes away pools and resting places for smaller species in the habitat.

Water Depth

Lack of flow	Often restricts fish species from crossing based on their size and capabilities.
Corrugated pipes	Low water depth can halt stream flow and entrap smaller species unable to travel through the ripples of a metal pipe.

Bank Width and Substrate

Bank edges	Lack of continued bank edges prohibit smaller species from travelling through crossings.
Discontinuity of substrate	Streambed dwelling organisms are completely prohibited from travelling through crossings when baffles, rip rap, or no substrate at all exist on a culvert's bottom.

¹"River and Stream Continuity Project." River and Stream Continuity. N.p., n.d. Web. 14 Oct. 2014.
<http://www.streamcontinuity.org/index.htm>

2.5.2 Environmental Significance

CMRPC has recognized the importance of the RSCP in their ongoing study of the Route 31 Corridor. In the “Bridge Management System” chapter of their Corridor Study, they recommend to “consider participation in Umass-Amherst “River and Stream Continuity Project”. This project surveys, assesses, and prioritizes road-stream crossing structures for replacement” (CMRPC 102).

Spencer has several reservoirs and ponds that contribute water to crossings associated with the Corridor study as well as throughout the rest of the Town. A significant amount of wildlife resides in the area including over twenty potential vernal pools serving as active habitats. The environmental impact can vary from dry streams collecting stormwater with outdated culverts to serious scour pools in riverbeds blocking fish passage. Other impacts can be seen in the design of some of the crossings. Through the inventory collected in the area, the crossings with the most significant need for maintenance and reconstruction were determined. A map produced by CMRPC depicting these environmental relationships can be found in Appendix B.

3.0 Methodology

The goal of this project was to assist the Town of Spencer and the River and Stream Continuity Project in updating their respective culvert databases and to provide short and long term recommendations to the Town on each culvert. The team accomplished this goal through the following tasks:

- Determining geographic scope with project liaison, Steve Tyler, based on existing inventories in the Town
- Global Positioning System (GPS) mapping of the location of culverts included in the geographic scope
- Assessing the culverts using the methods required by the River and Stream Continuity Project and updating that project's database
- Designing a structural assessment form
- Providing short and long term recommendations on each culvert by considering the structural and aquatic scores, field notes, and previous research by other agencies

The methods used to complete these tasks are outlined in the following sections, along with a geographic description of the scope of this project.

3.1 Scope Development

Much of the information and resources used throughout this project were provided by the project sponsor, Steven J. Tyler, P.E., of the Town of Spencer's Water Department. The team and project advisor, Professor Le Page, first met with Mr. Tyler on September 12, 2014 to review the scope and goals of the MQP. The meeting focused on possible project outcomes and

the selection of culverts to be investigated. Additionally, Professor Scott Jackson's River and Stream and Continuity Project was discussed and the team agreed to include his work in this project. Mr. Tyler also provided a previous National Bridge Inspection Standards (NBIS) report done in Spencer on four of the culverts in the scope as well as granted the group access to the Central Massachusetts Regional Stormwater Coalition (CMRSWC) database, which is utilized by Spencer in order to map outfalls and determine stormwater strategies within the region. Later in the week, the team received an Excel file from Central Massachusetts Regional Planning Commission (CMRPC) that contained assessments on eleven culverts as part of their transportation corridor study of Rt. 31. The functions of these agencies were discussed previously in Section 2.4 of this report. These inventories proved valuable when designing the culvert profiles for the Town of Spencer.

This project included twenty-two culverts along four different roads within Spencer. These culverts were chosen with collaboration between Mr. Tyler and the team with a focus on trying to provide the most useful service to the Town. The culverts on South Spencer Road and Meadow Road had not yet been mapped. By choosing the culverts on North Meadow Road the team provided a follow-up to CMRPC's corridor study that would also include environmental analysis. Lastly, the West Main Street culvert was included because the team found the area interesting and believed it would add value and variety to the report.

The area spanned from the Southwest corner to the Northeast corner of the Town and included six different types of culverts. Table 3 indicates what kinds of culverts are located on each road, while Figure 11 highlights the geographic scope of this project.

Table 3: Culvert Type per Road

Road Name	Metal Pipe	Concrete Pipe	Masonry	Double-Pipe	Box	Open-Bottom Box	Total
South Spencer Road	5.5*	1.5*	3	-	-	1	11
West Main Street (Rt. 9)	-	-	-	-	1	-	1
Meadow Road	-	1	-	1	-	-	2
North Spencer Road (Rt. 31)	2.5*	3.5*	-	-	-	2	8

* Two culverts are split (1/2 metal, 1/2 concrete)



Figure 11: Geographic Scope (highlighted route)

3.2 GPS Mapping

The team used a Leica GPS device to map the location of culverts within the project's scope. This process began with a field orientation with an intern at Spencer's Water Department, Tyler Stearns. This orientation took place on September 22, 2014 and included an explanation of the mapping process and how to use the field form on the tablet associated with the Leica device. The Leica device's form includes structural details of the culvert such as pipe diameter, pipe condition, and pipe material in addition to GPS coordinates. Following the review, Tyler and the team mapped the two north-most culverts involved in the project.

Over the following two weeks the team finished the mapping process. The culverts were located by using paint markings on the street that signify water is crossing under the road as well as maps provided by the project liaison, Mr. Tyler, that outlined the general location of culverts. The locations of these culverts were mapped and uploaded to the Spencer CMRSWC website for the team to review and use as a reference for future work within the Town.

3.3 River and Stream Continuity Project Training

As discussed with Mr. Tyler during the first client visit, there was a desire to get Spencer involved with the River and Stream Continuity Project (RSCP) that has been steadily growing throughout New England and the Atlantic region. The MQP team reached out to Professor Scott Jackson at the University of Massachusetts (UMass) and expressed interest in becoming involved in his work. He responded with background material on the RSCP and encouraged the team to take part in a training session on the methods of his project. Once trained, volunteers are permitted to assess road-stream crossings and input data into the RSCP's inventory.

A training session typically consists of a three-hour indoor portion and a two-hour field portion. The team set up the training for November 22, 2014 to take place at Spencer's Water Department and include Steve Tyler and Tyler Stearns. During the indoor portion, Professor Jackson reviewed the goals and background of his project as well as how it has greatly expanded over time. He taught the attendees what to look for in the field and the methods to filling out the Road-Stream Crossing Inventory field data form. The field data form is accompanied with a longer instruction guide packet that can be referenced by volunteers until they become familiar with the process. A completed field data form is included in Section 4.2 and the instruction guide can be found in Appendix C of this report.

The trainees then accompanied Professor Jackson outside to practice the methods on three culverts within the MQP's geographic scope. Separated into groups of three, the trainees filled out field data simultaneously with Professor Jackson on each of the culverts. Once completed, the results were reviewed and calibrated to match Professor Jackson's form. This process helps ensure quality control within the RSCP.

3.3.1 Road-Stream Crossing Inventory

The project team took inventory of the culverts within the scope using the methods and field data form provided by Professor Jackson. This inventory was completed on two field trips; December 14th and 18th, 2014. The field data forms were then uploaded to the RSCP's database along with a picture of the inlet and outlet of each culvert. The benefit of using this method is that when the information on the field data form is entered into the database, it rates the culvert on its ability to support the passage of wildlife and provides an aquatic score ranged from zero to one, a process described in Section 2.5 of this report. These scores became part of

the evaluation criteria the team used to prioritize culverts. During these field trips, the team took additional pictures and notes to also assist with the evaluation process.

3.4 Structural Assessment Design

Professor Jackson also noted that a structural assessment form to accompany his field data form was continually being developed but not his main point of interest or expertise. He revealed how such an assessment would be useful and when paired with his inventory would provide a deeper understanding of a culvert. This led to the team contemplating the feasibility of designing a structural assessment form.

The design process began on December 10th, 2014 when the team met with Professor Albano of WPI's Civil Engineering Department. The discussion consisted of what main issues to look for when assessing the structural integrity of a culvert. Professor Albano also noted that certain categories carry more weight than others. For example, a culvert with all high scores but one low score can still be in critical condition; parallel with the "a chain is only as strong as its weakest link" idiom.

The team continued the process of designing a structural assessment tool for culverts by researching the different components of culverts and selecting the elements that were believed to be the most important to the structural integrity of the culvert. Through research and a follow-up meeting with Professor Albano, the team decided on the critical and additional categories that should be evaluated.

The critical categories determined were cracking, headwall/wingwall, scour, and embankment. The team then created a grading system to give a condition rating to each aspect of the culvert individually. This system gave a score of 1.0 to elements with a "New" condition,

0.75 for a “Good” condition, 0.50 for a “Fair” condition, 0.25 for a “Poor” condition, and a zero for a “Critical” condition. The overall scoring system used a range from 0.0-1.0 to allow this structural assessment to be comparable with the Aquatic Score that came from the River and Stream Continuity Project inventory method.

After developing the scoring system for the structural condition of the culvert, the team selected five culverts to test it on. The five culverts selected provided a variety of culvert types and were located on different roads to check the performance of the scoring system in different scenarios. This calibration test showed the team that the scores were lower than expected and that the “New” category was not required. For example, an overall condition of “Fair” only gave a culvert a score of 0.50. This seemed low because the “New” category was not very realistic in the field; the culvert would have to be constructed extremely recently to receive a “New” condition. Based on these observations, the team changed the scoring system to give a score of 1.0 to elements with a “Good” condition, 0.67 for a “Fair” condition, 0.33 for a “Poor” condition, and 0.0 for a “Critical” condition. An addition was made to the scoring system to note the culverts that had a “Poor” condition rating in the categories determined to be critical to the structural integrity of the culvert. The field data form is displayed below:

Table 4: Structural Assessment Field Data Form

	Good (1.00)	Fair (0.67)	Poor (0.33)	Critical (0.00)	Unknown	N/A
Invert Deterioration	<input type="checkbox"/>	<input type="checkbox"/>	<input type="checkbox"/>	<input type="checkbox"/>	<input type="checkbox"/>	<input type="checkbox"/>
Joints & Seams	<input type="checkbox"/>	<input type="checkbox"/>	<input type="checkbox"/>	<input type="checkbox"/>	<input type="checkbox"/>	<input type="checkbox"/>
Cracking	<input type="checkbox"/>	<input type="checkbox"/>	<input type="checkbox"/>	<input type="checkbox"/>	<input type="checkbox"/>	<input type="checkbox"/>
Headwall/Wingwall	<input type="checkbox"/>	<input type="checkbox"/>	<input type="checkbox"/>	<input type="checkbox"/>	<input type="checkbox"/>	<input type="checkbox"/>
Apron	<input type="checkbox"/>	<input type="checkbox"/>	<input type="checkbox"/>	<input type="checkbox"/>	<input type="checkbox"/>	<input type="checkbox"/>
Pipe Damage	<input type="checkbox"/>	<input type="checkbox"/>	<input type="checkbox"/>	<input type="checkbox"/>	<input type="checkbox"/>	<input type="checkbox"/>
Scour	<input type="checkbox"/>	<input type="checkbox"/>	<input type="checkbox"/>	<input type="checkbox"/>	<input type="checkbox"/>	<input type="checkbox"/>
Cross-section deformation	<input type="checkbox"/>	<input type="checkbox"/>	<input type="checkbox"/>	<input type="checkbox"/>	<input type="checkbox"/>	<input type="checkbox"/>
Longitudinal alignment	<input type="checkbox"/>	<input type="checkbox"/>	<input type="checkbox"/>	<input type="checkbox"/>	<input type="checkbox"/>	<input type="checkbox"/>
Footing	<input type="checkbox"/>	<input type="checkbox"/>	<input type="checkbox"/>	<input type="checkbox"/>	<input type="checkbox"/>	<input type="checkbox"/>
Roadway over Culvert	<input type="checkbox"/>	<input type="checkbox"/>	<input type="checkbox"/>	<input type="checkbox"/>	<input type="checkbox"/>	<input type="checkbox"/>
Blockage at Inlet	<input type="checkbox"/>	<input type="checkbox"/>	<input type="checkbox"/>	<input type="checkbox"/>	<input type="checkbox"/>	<input type="checkbox"/>
Embankment	<input type="checkbox"/>	<input type="checkbox"/>	<input type="checkbox"/>	<input type="checkbox"/>	<input type="checkbox"/>	<input type="checkbox"/>

The highlighted rows are the critical categories. A “Poor” condition rating in one of those four categories or a “Critical” condition in any category would require attention from the assessor.

Due to excessive amounts of snow during February 2015, the team performed the assessment using field notes and pictures that had been acquired through previous site visits and produced structural scores for each of the culverts. These results can be found in Section 4.4.

The last step in the design of the structural assessment was to create an instruction guide packet containing pictures and a description for each condition. This instruction guide could be used in the field until the assessor becomes familiarized with the examples and process. The pictures and condition descriptions were adopted from the Department of Transportation (DOT) from several states throughout the country who currently employ their own assessment for culverts including the Oregon DOT, the Minnesota DOT, and the

Connecticut DOT. This packet serves as an instruction guide for a technician to use in the field when assessing a culvert because it provides pictures and a written description of all condition ratings for each category. The instruction packet is located in Appendix D of this report.

3.5 Culvert Profiles

Once the initial inventory was completed, the team also began developing the concept of a culvert profile; an easy to read form that would provide the Town with any relevant information about that particular culvert as well as short and long term recommendations. This form would be made for all twenty-two culverts and use information that had been collected throughout the project's duration. There were several factors considered during this step. While the aquatic and structural scores were included, the team also considered traffic patterns, quality of the road, and potential issues involved with replacing the culvert. The following sections will outline the methods used to gather the information in each section of the two-page culvert profile.

3.5.1 Field Observations and Notes

The first page of the culvert profile includes boilerplate information about the culvert including type, diameter, length, and several other characteristics. Any field notes from the inventory process are also included as well as an inlet and outlet picture taken by the team. This information was acquired primarily through field visits with a few additional notes coming from resources provided by project sponsor, Steve Tyler. Crossings that were involved in the NBIS regular assessment include date built and bridge number in the notes section. The aquatic

assessment result from Professor Jackson's database is also depicted on the profile as well as the structural score produced by the team's designed assessment.

3.5.2 Improvement Considerations

With feedback from Mr. Tyler on what information would be helpful on the culvert profile, the team included a section called "Improvement Considerations". This section includes short and long term recommendations as well as a replacement materials ranking.

The short term recommendations were determined by analyzing the field conditions and deciding what immediate actions could improve the functionality of the road-stream crossing. Many of these improvements were revolved around removing debris and addressing clogging issues; essentially routine maintenance. Culverts that did not have any immediately fixable issues, were given recommendations more geared towards continuing routine assessments and tracking scouring patterns at the inlet and/or outlet. Similarly, culverts that carried discolored and odorous water were advised to receive a water quality test.

The long term recommendations were determined by factoring how any field issues could worsen over time. Many culverts are functional for the time-being, but eventually are going to need a replacement. Culverts that had large scour pools at the outlet or capacity issues were recommended to be upgraded to a larger pipe size. Many times, a road resurfacing was also recommended based on pavement condition above the crossing. Future plans for the roadway were also considered during the long term analysis. Mr. Tyler provided the team with future plans during the February site visit; Meadow Road is slated for a resurfacing that will widen the road and add sidewalks. He also noted that North Spencer Road will be resurfaced

before South Spencer Road. This information was taken into account while determining the long term consideration.

The team also developed a replacement materials rank estimating how much infill material would be required to replace the culvert. This process consisted of multiplying the width, length, and depth from the road of each crossing and ranking the infill outcome against the other culverts. The width and length of the culverts were acquired throughout the inventory process. During this process, the team also estimated the height of fill from the road to the top of each culvert. While the resulting estimate does not factor in type of culvert material or additional site work, it provides the Town with a rough idea of how extensive replacing that culvert would be. The excel sheet displaying the rankings is included in Appendix E.

The rankings then were conditionally formatted on Microsoft Excel to provide an easy to read bar showing how high that culvert was ranked against the others. An example of the ranking is provided below:

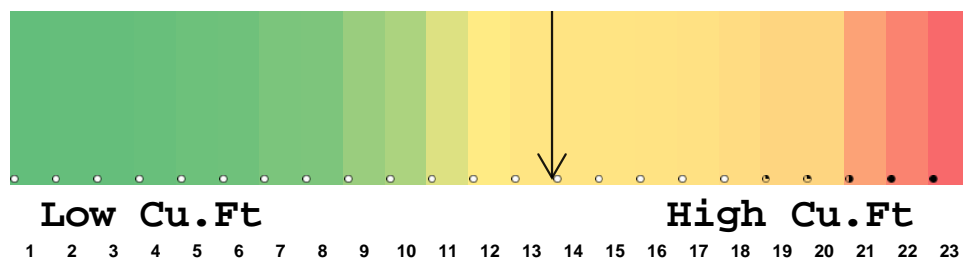

Figure 12: Replacement Materials Rank

3.5.3 GIS Maps and Impact

The second page of the culvert profile includes GIS maps displaying traffic data, priority habitats, and road-stream crossings and an impact description. To create these maps the team

used the program ArcGIS available on WPI's computer network. A review follows noting the layers needed for completing this procedure.

The base layer was needed to outline the State and Town borders throughout Massachusetts. This was obtained from the Massachusetts Office of Geographic Information Systems (MassGIS). MassGIS provides a variety of geographic data for viewing and downloading on their website. The road layer within the Town of Spencer is also available through MassGIS. During the GIS process, maps demonstrating traffic volume data found by the MassDOT were also analyzed. A sample of this layered map is provided below.

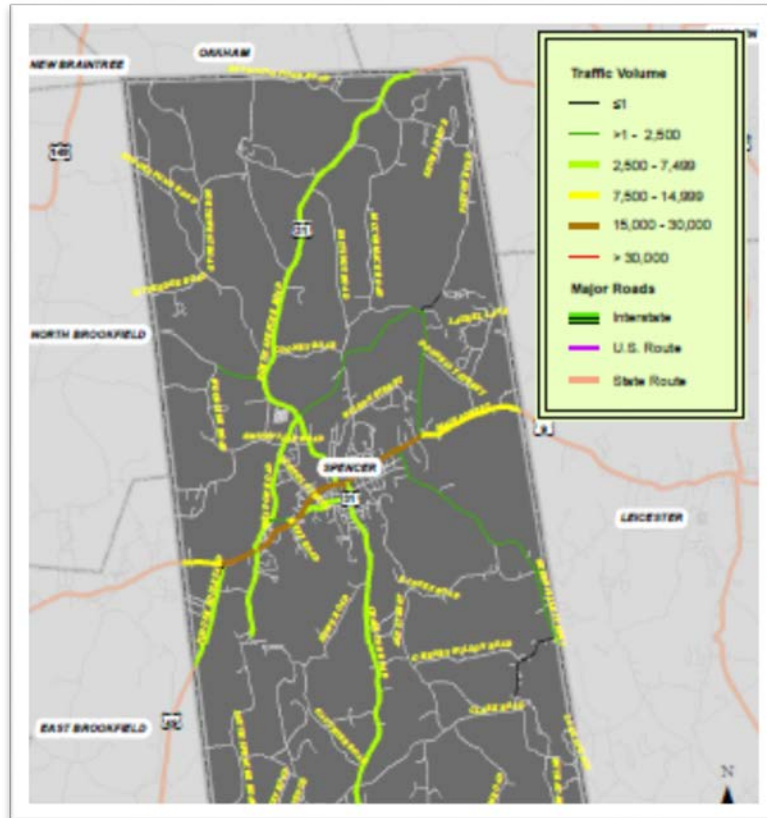

Figure 13 - Traffic Data in Spencer

Next, layers were added approximating all waterways of the Chicopee Watershed and Priority Habitats defined by the National Heritage & Endangered Species Program. This gave the

team an idea of what waterways and habitats the culverts within the scope were interacting with. These layers were also obtained from MassGIS.

The River and Stream Continuity Database provided another useful layer for the GIS map. The Town's culverts could be viewed on the database and exported as a shape file. This file was provided after the approval of each inspected culvert by the database's administrators. The use of this shape file in the culvert profiles displays the level of accuracy in the River and Stream Continuity Project (note the crossings of the Chicopee Watershed and the roads lining up with the superimposed crossing layer in Section 4.2).

Finally, the team proposed detour routes in the event of a culvert collapsing or for the duration of a reconstruction or replacement project. The detour routes demonstrated in the profiles are modeled after descriptions found on Google Maps. Both road names and detour time delays were analyzed through the comparison of the alternate route nearest geographically.

The GIS map can provide a variety of information not displayed visually in this report. In-depth data, for certain layers, provided insight used for further conclusion discussed in the impact portion of the culvert profiles. This data included displays in Spencer such as vernal pools, habitats of rare species, and further physical and census information.

Additional impacts were gathered through multiple public resources as well as field visits throughout the fall and early winter in 2014. Online resources included detailed traffic count data on the websites of the MassDOT and CMRPC. The compilation of these sources provided a full assessment of potential impacts regarding each culvert located and examined.

3.6 Project Deliverables

This project culminated in a Major Qualifying Project report and a poster to be presented on Project Presentation Day at WPI. Furthermore, the final deliverables for the project included the GPS mapping data that was uploaded to the Spencer CMRSWC website. This provided Spencer with a more complete database than previously existed. Another project deliverable was the inventory data sheets for each of the culverts under investigation. These sheets were uploaded to the River and Stream Continuity Project's database and will help the continued expansion of Professor Jackson's project. The team also provided the Town of Spencer and Professor Jackson with a simple to use structural assessment form that was designed throughout the project's duration. This form and instruction guide will be a useful addition to the RSCP's methods. Finally, the team provided a culvert profile on each of the twenty-two culverts observed that contains important data on each culvert as well as short and long term recommendations.

4.0 Results and Recommendations

This section will present the results produced within each stage of this project. It culminates with the culvert profiles, which include short and long term recommendations for the Town of Spencer.

4.1 GPS Mapping

The first task of the project was to map the culverts selected for the study to the Central Massachusetts Regional Stormwater Coalition's database. The results are point locations signifying outfalls that include latitude, longitude, and elevation data. A screenshot of the culverts on South Spencer Road from the database is shown in Figure 14.

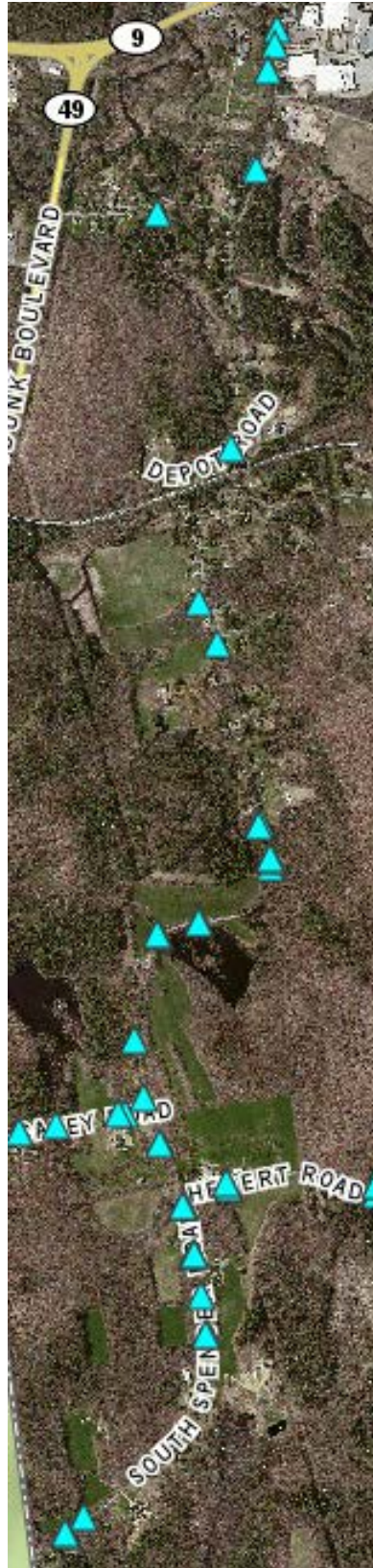

Figure 14: CMRSWC GPS mapping

4.2 River and Stream Continuity Project

As noted in Section 3.3 of this report, the team was trained in the methods of the River and Stream Continuity Project by Professor Scott Jackson. Over several field visits, the team assessed twenty-two culverts and uploaded the field forms to his database. An example of a field data form that the team completed is shown in Figure 15.



[Search Crossings](#) | [Login](#)

General Information for Road-Stream Crossing
 Crossing Code: **xy4219166172017763** Aquatic Score: **0.47**
 Terrestrial Passability Score: **0.0**
 (Data entry checked and accurate)



Coordinator: Seamus Gallagher (last login: 03-04-2015)	Crossing Code: xy4219166172017763	First entered: 01-13-2015
Stream/River: unknown	StreamID: No data	Road: South Spencer Road
Date observed in field: 12-14-2014	Last updated: 01-20-2015	Town: Spencer, MA
Observer: Scott Jackson	Location: pole 80-50	NHD-HUC8 Watershed: Chicopee
GPS: Lat: 42.19601 , Long: -72.01447	GPS to crossing distance (meters): 555.1	Flow condition: Higher than average
Photo IDs: No data	Phone: 413-545-4743	NY ID: No data
		Email: sjackson@umext.umass.edu

Road/Railway Characteristics:

Road Surface:	Paved
Road Type:	2-Lane Road
Comment:	No data

Crossing/Stream Characteristics (during generally low-flow conditions)

Crossing type:	Single Culvert
Condition of crossing:	Fair
Does the stream at the crossing contain fish?	Yes
Is the stream flowing (in the natural channel)?	Yes
Crossing span:	Severe Constriction
Scour pool:	None
Crossing alignment matches stream?	No (skewed)
Comment:	No data

Standard of this stream crossing is estimated as: **SIGNIFICANT BARRIER**

Culvert/Bridge Cell Characteristics:

Total Number of Culverts: 1

This is culvert number 1 for this crossing:

Length of stream through structure: L = 40.58 Feet	
Inlet structure type: Round Culvert	
Inlet dimensions (feet): A = 1; B = 0; C = 0; D = 0;	
Inlet water depth (inches): 1 Measured	
Inlet drop (inches): 0 Measured	
Inlet openness ratio: 0.0193445046821	
Outlet structure type: Round Culvert	
Outlet Dimensions (feet): A = 1; B = 0; C = 0; D = 0;	
Outlet water depth (inches): 1 Measured	
Outlet drop:	
a. Culvert bottom to water surface (inches): 0 Measured	
b. Culvert bottom to stream bed (inches): 0 Measured	
c. With an outlet drop, check one: No drop	
Outlet openness ratio: 0.0193445046821	
Structure embedded?	Not embedded
Crossing substrate?	None (rough/corrugated)
Internal features?	None
Physical barriers to fish and wildlife passage:	Severe
Describe any barriers:	tree down at outlet
Is there a clear line of sight through the structure?	No
Does the structure provide dry passage suitable for use by terrestrial wildlife?	No
If yes, what is the maximum structure height in the portion that offers dry passage?	No data
Comments:	No data
Water depth matches that of the stream?	No (shallower)
Water velocity matches that of the stream?	Yes (comparable)
Crossing slope matches of the stream:	Yes (comparable)
Armored streambed at outlet?	None

Inlet structure:

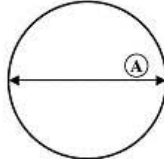

Outlet structure:

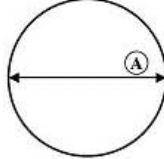
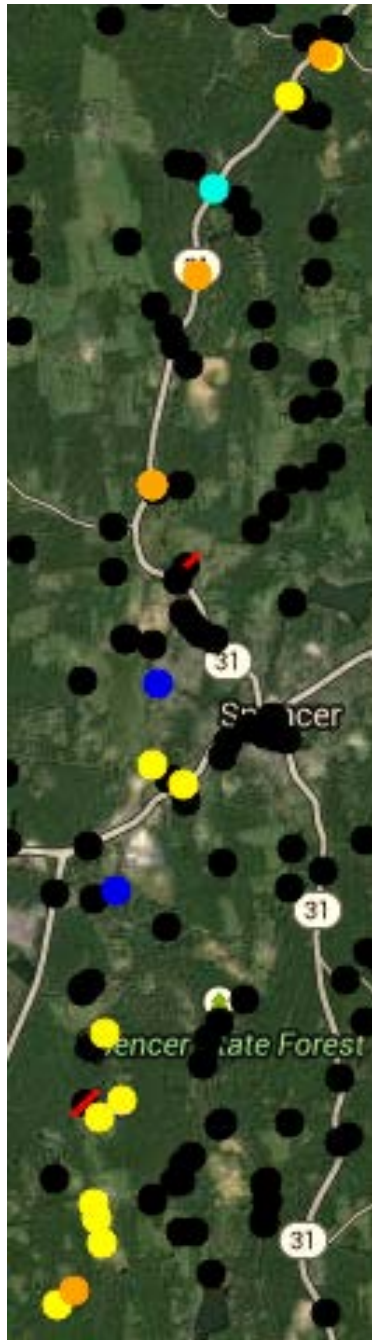

Figure 15: River and Stream Continuity Project field data form

The database assesses what is input and produces an Aquatic Score and determines how significant of a barrier the crossing is. Instructions for viewing the database's results for the Town of Spencer is included in Appendix F. The final product of the RSCP's assessment is a map relating each crossing with a color describing its aquatic score. This map along with a key describing each color is presented in Figure 16. The black circles represent crossings found using GIS that have not been assessed yet.



- Full Passage: green ●
- Insignificant barrier: blue green ●
- Minor barrier: blue ●
- Moderate barrier: yellow ●
- Significant barrier: orange ●
- Severe barrier: red ●
- Crossing removed: magenta ●
- No crossing: black circle with bold red x ❌
- New crossing pending approval: black circle with red slash 🚧

Figure 16: RSCP Aquatic Scores with Key

4.3 Structural Assessment Design

The following section describes the structural assessment that the team designed. Each category is reviewed and the conditions associated with it are described. The design process concluded with a structural assessment field data form, an instruction packet, and a structural assessment score for each of the scoped culverts.

4.3.1 Invert Deterioration

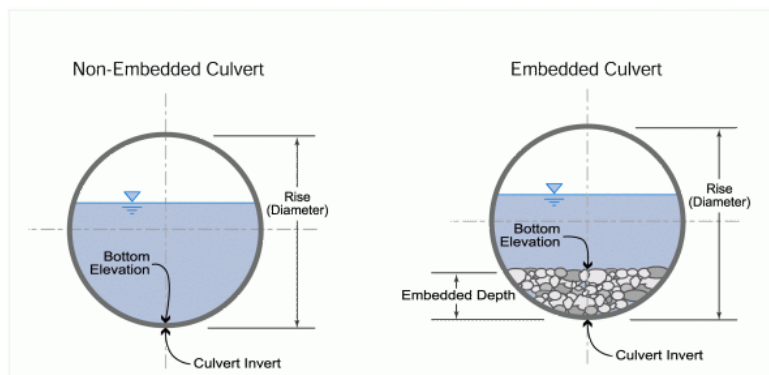

Figure 17: Culvert with Invert Diagram

The invert is an important part of the structural integrity of the culvert and can greatly impact the performance of the culvert. As seen in Figure 17, the invert is located at the bottom of a pipe culvert. Typical problems seen with the invert are corrosion, abrasion, displaced mortar or masonry blocks, and the failure of connection hardware. These problems persist at the invert because water either flows through this area or ponds there. Deterioration of the invert of a culvert tends to lead to problems at other areas of the culvert, such as the embankment, because holes in the invert allow water to infiltrate the soil.

The condition descriptions and example pictures of each condition for the invert deterioration category can be seen in full in the Structural Assessment Packet located in Appendix D. The invert deterioration category “Good” and “Fair” descriptions, shown in Table

5, came from the Oregon Department of Transportation (ODOT) Highway Division’s Culvert Inspection & Inventory Field Handbook, and the “Poor” and “Critical” descriptions came from a Culvert Condition Assessment Form given to the team by Scott Jackson that was in the developmental stage.

Table 5: Invert Deterioration Condition Descriptions

Good	No visual damage or only superficial corrosion or scaling of the invert.¹
Fair	Minor corrosion and pitting, no holes or distortion. Cannot penetrate metal with sharp point of geology hammer. Minor isolated spalls in concrete. ¹
Poor	Perforations visible and/or connection hardware failing (metal). Heavy abrasion and scaling with exposed steel reinforcement (concrete). Heavy abrasion or scour damage (plastic). Displaced mortar and/or blocks, holes in invert area (masonry). ²
Critical	Holes or section loss with extensive voids beneath invert and/or embankment/roadway damage. Holes and gaps with extensive infiltration of soil, bedding, or backfill material (masonry). ²
¹ Trevis, Robert E., P.E. "Culvert Inspection & Inventory Field Handbook." (n.d.): n. pag. Oregon Department of Transportation, 13 Mar. 2013. Web. 1 Feb. 2015. ² "Culvert Condition Assessment Form." River and Stream Continuity. N.p., n.d.	

4.3.2 Joints & Seams

The joints and seams of a culvert have structural significance because their failure allows for the infiltration of backfill into the culvert, which can result in the failure of the culvert. Joints and seams in good condition allow the culvert to function as it was designed. As they deteriorate, soil fills the culvert barrel and water leaves the pipe through openings causing other problems with the soil around the pipe.

Table 6: Joints and Seams Condition Descriptions

Good	Joints and seams are tight with no openings.¹
Fair	Minor separation of joints and seams up to 1", minor backfill infiltration. ¹
Poor	Significant separation of joints and seams between 1" to 3"; infiltration of backfill into culvert; voids visible in fill through offset of joints. ¹
Critical	Severe separation of joints and seams greater than 3"; infiltration of backfill into culvert; large voids visible in fill through offset of joints. ¹
¹ Trevis, Robert E., P.E. "Culvert Inspection & Inventory Field Handbook." (n.d.): n. pag. Oregon Department of Transportation, 13 Mar. 2013. Web. 1 Feb. 2015.	

4.3.3 Cracking

The cracking category of the Structural Assessment is specific to the type of material the culvert is made of. Table 7 describes how each material typically experiences cracking.

Table 7: Cracking Types for Different Materials

Material	Cracking Types
Concrete	<ul style="list-style-type: none"> • Longitudinal cracks • Spalling that exposes rebar
Metal	<ul style="list-style-type: none"> • Cracking near bolt holes • General cracking in pipe
Plastic	<ul style="list-style-type: none"> • Rips and tears
Masonry	<ul style="list-style-type: none"> • Weathering • Misalignment of blocks

These failure methods are all caused by the loads exerted on the pipe being greater than the design loads. This category was marked as one of the most critical by the project team because if left unchecked, cracking has

the potential to collapse the entire culvert and the road above it. For this reason it was determined that this category was more critical than most other categories and should be monitored more closely as its condition degrades. Culverts that received a "Poor" grade in this category had their final score marked in red on the culvert profiles to note that they need to be inspected further. The specific condition descriptions for cracking in the different types of culverts are located in Appendix D.

4.3.4 Headwall/Wingwall

Headwalls have several advantages for culverts, such as preventing large pipes from floating out of the ground when they plug, reducing the required length of a pipe, increasing the capacity of a pipe, assisting the movement of debris through a pipe, retaining backfill material, and decreasing the chance of failure if a culvert is overtopped (“Low Volume Roads BMPs” 87). Wingwalls are included on the majority of designs that have a headwall because they also help to reduce culvert length and add the benefit of reducing the area that requires erosion protection (“Hydraulic Design of Energy Dissipaters for Culverts and Channels” 17). The team determined that this category was one of the most critical because the failure of the headwall or wingwall of a culvert could lead to a collapse of the entire culvert due to the pipe length and capacity being designed with the headwall and wingwall. Culverts that received a “Poor” grade in this category had their final score marked in red on the culvert profiles to note that they needed to be inspected further. The structural assessment packet in Appendix D has example pictures for each condition description.

Table 8: Cracking Condition Descriptions

Good	Little or no cracking, rotation, or displacement. Light concrete scaling, metal corrosion, or other surface deterioration.³
Fair	Minor cracks and spalls in concrete. Minor rotation and/or displacement with gap in barrel seam. Minor footing exposure. ³
Poor	Area affected by cracking and spalling is >50% and/or rebar exposed. Significant displacement at cracks or wall rotation causing a gap at the wall-to-barrel interface >4". Footing exposed and undermined. ³
Critical	Partially or totally collapsed, with resultant damage to embankment and/or roadway damage. ³
³ Hunt, John H., Stephen M. Zerges, Brian C. Roberts, and Bart Bergendahl. "Culvert Assessment and Decision-Making Procedures Manual For Federal Lands Highway." (n.d.): n. pag. Federal Highway Administration, Sept. 2010. Web. 1 Feb. 2015.	

4.3.5 Apron

Culvert aprons are used to reduce or prevent scour and erosion at both the inlet and outlet of a culvert. These structures are often found on culverts that also have a headwall and wingwalls. Apron failure can significantly affect the performance of a culvert and also cause serious damage to a roadway and embankment (Hunt 18). The specific condition descriptions for aprons and an example picture of each can be found in Appendix D.

Table 9: Apron Condition Descriptions

Good	No cracking, piping, or undermining.³
Fair	Minor cracking but no visible piping or undermining. ³
Poor	Significant cracking affects >50% of apron. Significant piping or undermining. ³
Critical	Partially or totally collapsed, significantly effecting performance and/or causing embankment and/or roadway damage. ³
³ Hunt, John H., Stephen M. Zerges, Brian C. Roberts, and Bart Bergendahl. "Culvert Assessment and Decision-Making Procedures Manual For Federal Lands Highway." (n.d.): n. pag. Federal Highway Administration, Sept. 2010. Web. 1 Feb. 2015.	

4.3.6 Pipe Damage

This category specifically focuses on water seeping through the culvert pipe, resulting in undermining of the pipe. Serious pipe damage for a culvert causes substantial problems for the embankment surrounding the pipe, especially when it reaches critical condition and sediment is being transported along with the water outside the pipe. Example pictures of each condition rating for the pipe damage category are located in Appendix D.

Table 10: Pipe Damage Condition Descriptions

Good	No signs of flow through embankment on outside of culvert barrel.¹
Fair	Embankment moist only in areas surrounding culvert barrel. No evidence of flow or sediment transport observed. ¹
Poor	Evidence of seepage through the embankment along the outside of the culvert barrel, sediment transport not observed. ¹
Critical	Evidence of flow through embankment along the outside of culvert barrel. Evidence of sediment transport observed. ¹
¹ Trevis, Robert E., P.E. "Culvert Inspection & Inventory Field Handbook." (n.d.): n. pag. Oregon Department of Transportation, 13 Mar. 2013. Web. 1 Feb. 2015.	

4.3.7 Scour

The team determined scour to be one of the critical categories in the structural assessment due to its ability to undermine a culvert and cause serious damage to the surrounding embankment and to the roadway over the culvert. Scour is caused by increased water velocities inside the culvert that lead to the washing away of sediment at its outlet. When the scour hole at the outlet becomes large enough, the culvert becomes undermined resulting in its failure. Scour can also expose a culvert’s footings, which can create further problems for the structural integrity of the culvert. Example pictures for each condition rating for scour are located in Appendix D. Culverts that received a “Poor” grade in this category had their final structural condition score marked in red on the culvert profiles to note that they needed to be inspected further.

Table 11: Scour Condition Descriptions

Good	No visual evidence of culvert undermining or exposed footings. Only minor scour hole is present. Culvert span to scour hole depth ratio is greater than 10.¹
Fair	Minor undermining of the culvert barrel or top of footing is exposed. Culvert span to scour hole depth ratio is between 5 to 10. ¹
Poor	Significant undermining of the culvert barrel or undermining of the footing. Culvert span to scour hole depth ratio is between 2 to 5. ¹
Critical	Extensive undermining of the culvert barrel or footing. Culvert span to scour hole depth ratio is less than 2. ¹
¹ Trevis, Robert E., P.E. "Culvert Inspection & Inventory Field Handbook." (n.d.): n. pag. Oregon Department of Transportation, 13 Mar. 2013. Web. 1 Feb. 2015.	

4.3.8 Cross-section deformation

The cross-section deformation category focuses on the flattening of the invert and the crown of the culvert in question. The team determined this was a category that needed to be examined because if the culvert is experiencing flattening, the loads the culvert was designed to carry may be greater than the actual loads. This deformation or flattening can also be a precursor to cracking, which is one of the most critical categories in the structural assessment. Different culvert materials each have individual standards when examining cross-section deformation. Therefore condition descriptions and a chart showing the level of deformation that falls into each category are located in Appendix D.

4.3.9 Longitudinal alignment

The longitudinal alignment category of the structural assessment is important because if a culvert is misaligned badly it can increase the scour at the outlet of the culvert. Also if the culvert is severely misaligned it can become a candidate for redesign. The condition ratings and an example picture of each condition can be found in the structural assessment packet in Appendix D.

Table 12: Longitudinal Alignment Condition Descriptions

Good	Angle measured from upstream channel to centerline of culvert barrel is from 0-15 degrees.¹
Fair	Angle measured from upstream channel to centerline of culvert barrel is from 15-45 degrees. ¹
Poor	Angle measured from upstream channel to centerline of culvert barrel is from 45-75 degrees. ¹
Critical	Angle measures from upstream channel to centerline of culvert barrel is larger than 75 degrees. ¹
¹ Trevis, Robert E., P.E. "Culvert Inspection & Inventory Field Handbook." (n.d.): n. pag. Oregon Department of Transportation, 13 Mar. 2013. Web. 1 Feb. 2015.	

4.3.10 Footing

The footing category of the structural assessment is mainly used when evaluating a bridge or a box culvert. If the footing of the culvert or bridge is exposed to the elements it leads to a quicker deterioration of the footing. Therefore there are two aspects to this category: the level of footing exposure and the condition of the footing itself. The footing is vital to the structural integrity of the culvert, but it was not marked as one of the critical categories in this assessment because they are mostly found on bridges, which have more regular inspections. However, the footing should be closely monitored because of its potential to collapse a culvert. The condition ratings and example pictures of each condition are in Appendix D.

Table 13: Footing Condition Descriptions

Good	Little or no deterioration. Concrete - minor cracking, leaching, or scaling. Masonry - minor weathering (joints are sound). No footing exposed.⁴
Fair	Minor to moderate deterioration. Concrete - moderate cracking, scaling or leaching (minor delamination or spalling). Masonry - moderate weathering (minor joint deterioration). Slight settlement or undermining. Minor footing exposure. ⁴
Poor	Extensive deterioration. Concrete - extensive cracking, scaling or leaching (delamination or spalling may be prevalent). Masonry - extensive weathering (significant joint deterioration). Significant settlement or undermining. Footing exposed and undermined. ⁴
Critical	Severe or critical deterioration. Function or structural capacity of the culvert has been severely impacted - immediate repairs or structural analysis may be required. Concrete - severe cracking, scaling, delamination, or spalling. Masonry - severe weathering (failed joints or displaced masonry blocks) Severe settlement or undermining. ⁴
⁴ Wilson, Pete. "Culvert Inspection, Condition Ratings & Inventory Coding." (n.d.): n. pag. Minnesota Department of Transportation. Web. 1 Feb. 2015.	

4.3.11 Roadway over Culvert

The roadway over the culvert is an important area to monitor when assessing the structural integrity of a culvert because a roadway in poor condition suggests that there are problems in other areas such as the invert, headwall, wingwall, apron, and scouring. This category is important because it affects every vehicle traveling over the culvert, especially when the condition reaches a “Poor” rating. It was not determined to be a critical element in the structural assessment developed by the team, but should be seen as an indicator for problems that should be evaluated in other parts of the culvert. Routine maintenance can prevent some of the cracking seen in the roadway above the culvert, but if the same problems persist a full structural analysis of the culvert could be required. The condition ratings for the roadway over culvert category can be seen in Table 14, and example pictures for each condition are located in Appendix D.

Table 14: Roadway Condition Descriptions

Good	Pavement has no visible defects, small cracks, or maintenance patches.¹
Fair	Minor isolated cracking and spalled areas. ¹
Poor	Significant cracking, spalling, potholes, or maintenance patches affecting up to 20% of any single travel lane or shoulder. ¹
Critical	Extensive cracking, spalling, potholes, or maintenance patches affecting 20% or more of any single travel lane or shoulder. ¹
¹ Trevis, Robert E., P.E. "Culvert Inspection & Inventory Field Handbook." (n.d.): n. pag. Oregon Department of Transportation, 13 Mar. 2013. Web. 1 Feb. 2015.	

4.3.12 Blockage at Inlet

A blockage at the inlet of the culvert is an important aspect to monitor because as the blockage increases, it decreases the capacity of the pipe. Significant blockages can lead to flooding in some cases and becomes a serious problem when large storms hit a region. Routine maintenance and clearing the inlet periodically can fix this problem and prevent it from reaching a critical level. The condition ratings can be seen in the table below and example pictures of each condition are located in Appendix D.

Table 15: Blockage at Inlet Condition Descriptions

Good	Blockage occupies less than 10% of opening.¹
Fair	Blockage occupies 10-30% of opening. ¹
Poor	Blockage occupies 30-75% of opening. ¹
Critical	Blockage occupies >75% of opening. ¹
¹ Trevis, Robert E., P.E. "Culvert Inspection & Inventory Field Handbook." (n.d.): n. pag. Oregon Department of Transportation, 13 Mar. 2013. Web. 1 Feb. 2015.	

4.3.13 Embankment

The embankment is the final category that the team determined was critical to structural integrity of a culvert. Erosion and scour are the two main causes of the deterioration of the embankment. The team selected this category as critical because as the embankment

condition deteriorates, the culvert and roadway over it are susceptible to collapse. If the embankment is allowed to reach a critical condition it makes the roadway very dangerous to cross and also threatens to collapse the culvert below it. The condition ratings can be seen in the table below and example pictures of each condition are located in Appendix D. Culverts that received a “Poor” grade in this category had their final structural condition score marked in red to note that they needed to be inspected further.

Table 16: Embankment Condition Descriptions

Good	No noteworthy deficiencies which affect the condition of the embankment protection.¹
Fair	Riprap starting to wash away, minor erosion, and embankment protection is in need of minor repairs. ¹
Poor	Embankment protection is severely undermined causing significant erosion of embankment and should be reviewed for repairs. ¹
Critical	Embankment protection has failed causing severe scour of embankment and threatening the stability of the roadway embankment. ¹
¹ Trevis, Robert E., P.E. "Culvert Inspection & Inventory Field Handbook." (n.d.): n. pag. Oregon Department of Transportation, 13 Mar. 2013. Web. 1 Feb. 2015.	

4.4 Structural Assessment Testing

The team tested the structural assessment form on each of the twenty-two culverts. An example of a completed field assessment form is presented below. A blank copy of the form is also included in Appendix G, available for future use. The overall results of the structural assessment are summarized in Table 17.

STRUCTURAL ASSESSMENT FIELD DATA FORM

Date: 2/21/15 Technicians: Seamus Gallagher Weather: clear Road: South Spencer Town: Spencer
 GPS Coordinates: 42.190424, 72.019786 Other Location Notes: first culvert after Spencer town border

NOTE THIS FORM SHOULD BE COMPLETED USING THE STRUCTURAL ASSESSMENT PACKET AS A REFERENCE

	Good (1.00)	Fair (0.67)	Poor (0.33)	Critical (0.00)	Unknown	N/A
Invert Deterioration	<input type="checkbox"/>	<input type="checkbox"/>	<input type="checkbox"/>	<input type="checkbox"/>	<input checked="" type="checkbox"/>	<input type="checkbox"/>
Joints & Seams	<input type="checkbox"/>	<input type="checkbox"/>	<input type="checkbox"/>	<input type="checkbox"/>	<input checked="" type="checkbox"/>	<input type="checkbox"/>
Cracking	<input type="checkbox"/>	<input type="checkbox"/>	<input type="checkbox"/>	<input type="checkbox"/>	<input checked="" type="checkbox"/>	<input type="checkbox"/>
Headwall/Wingwall	<input type="checkbox"/>	<input type="checkbox"/>	<input type="checkbox"/>	<input type="checkbox"/>	<input type="checkbox"/>	<input checked="" type="checkbox"/>
Apron	<input type="checkbox"/>	<input type="checkbox"/>	<input type="checkbox"/>	<input type="checkbox"/>	<input type="checkbox"/>	<input checked="" type="checkbox"/>
Pipe Damage	<input type="checkbox"/>	<input type="checkbox"/>	<input type="checkbox"/>	<input type="checkbox"/>	<input checked="" type="checkbox"/>	<input type="checkbox"/>
Scour	<input type="checkbox"/>	<input checked="" type="checkbox"/>	<input type="checkbox"/>	<input type="checkbox"/>	<input type="checkbox"/>	<input type="checkbox"/>
Cross-section deformation	<input type="checkbox"/>	<input type="checkbox"/>	<input type="checkbox"/>	<input type="checkbox"/>	<input checked="" type="checkbox"/>	<input type="checkbox"/>
Longitudinal alignment	<input type="checkbox"/>	<input type="checkbox"/>	<input checked="" type="checkbox"/>	<input type="checkbox"/>	<input type="checkbox"/>	<input type="checkbox"/>
Footing	<input type="checkbox"/>	<input type="checkbox"/>	<input type="checkbox"/>	<input type="checkbox"/>	<input type="checkbox"/>	<input checked="" type="checkbox"/>
Roadway over Culvert	<input type="checkbox"/>	<input type="checkbox"/>	<input checked="" type="checkbox"/>	<input type="checkbox"/>	<input type="checkbox"/>	<input type="checkbox"/>
Blockage at Inlet	<input type="checkbox"/>	<input type="checkbox"/>	<input checked="" type="checkbox"/>	<input type="checkbox"/>	<input type="checkbox"/>	<input type="checkbox"/>
Embankment	<input type="checkbox"/>	<input checked="" type="checkbox"/>	<input type="checkbox"/>	<input type="checkbox"/>	<input type="checkbox"/>	<input type="checkbox"/>

Performance Problems:

Additional Comments:

Inlet is buried. Could not find it

Structural Condition Score: 0.47

Ryan Bagge, Kevin Galvin, and Seamus Gallagher

Figure 18: Completed Structural Assessment Form example

Table 17: Structural Assessment Test Results

Road	Culvert Number	Invert Deterioration	Joints and Seams	Cracking	Headwall/Wingwall	Apron	Pipe Damage	Scour	Cross-section Deformation	Longitudinal Alignment	Footing	Roadway over Culvert	Blockage at Inlet	Embankment	Structural Condition Score	
South Spencer Road	1	unknown	unknown	unknown	N/A	N/A	unknown	0.67	unknown	0.33	N/A	0.33	0.33	0.67	0.466	
	2	0.67	unknown	0.67	N/A	N/A	1.00	0.67	0.67	0.33	N/A	0.33	0.67	0.67	0.631	
	3	1.00	unknown	1.00	N/A	N/A	1.00	0.67	1.00	0.33	N/A	0.33	0.67	0.67	0.741	
	4	1.00	0.67	1.00	0.33	N/A	1.00	0.67	1.00	0.67	N/A	0.67	0.67	0.67	0.759	
	5	1.00	0.33	0.33	0.33	N/A	0.33	0.67	1.00	0.67	N/A	0.33	0.67	0.67	0.600	
	6	N/A	unknown	0.67	0.67	0.67	N/A	0.33	0.33	N/A	1.00	unknown	0.33	0.67	0.620	
	7	0.33	0.67	0.67	0.67	N/A	N/A	0.67	0.67	0.67	0.33	N/A	0.67	0.67	0.602	
	8	N/A	unknown	0.67	0.67	N/A	N/A	unknown	0.67	unknown	0.33	N/A	0.33	0.33	0.67	0.500
	9	1.00	0.67	1.00	1.00	0.67	N/A	1.00	0.67	1.00	0.67	N/A	0.67	0.67	0.790	
	10	0.67	unknown	unknown	unknown	1.00	N/A	0.67	unknown	1.00	0.67	N/A	0.67	N/A	0.67	0.764
	11	N/A	N/A	0.67	0.67	1.00	N/A	N/A	0.67	N/A	1.00	1.00	0.67	1.00	0.67	0.835
West Main Street	1	1.00	N/A	1.00	1.00	0.67	N/A	0.67	N/A	1.00	1.00	0.67	0.33	0.67	0.801	
Meadow Road	1	1.00	1.00	1.00	0.67	N/A	1.00	0.67	1.00	0.67	1.00	0.67	1.00	1.00	0.890	
	2	unknown	unknown	0.67	0.67	N/A	0.67	0.67	1.00	0.67	N/A	0.33	0.33	0.67	0.631	
North Spencer Road	1	N/A	N/A	1.00	0.67	N/A	N/A	0.33	N/A	0.67	0.67	0.67	1.00	0.67	0.710	
	2	1.00	unknown	1.00	0.67	N/A	1.00	0.67	1.00	0.33	N/A	N/A	0.67	0.67	0.779	
	3	1.00	unknown	1.00	0.33	N/A	1.00	0.67	1.00	0.67	N/A	0.67	0.67	0.67	0.768	
	4	0.67	unknown	0.67	0.67	N/A	0.67	0.67	unknown	0.67	N/A	0.67	0.67	0.67	0.670	
	5	N/A	0.67	0.67	0.67	0.33	N/A	0.67	N/A	1.00	0.67	0.33	1.00	0.67	0.668	
	6	1.00	0.67	0.67	0.67	N/A	N/A	0.67	1.00	0.67	N/A	0.33	unknown	0.33	0.668	
	7	1.00	0.33	0.67	0.67	N/A	N/A	0.67	1.00	0.33	N/A	0.67	0.67	0.33	0.600	
	8	0.67	0.67	0.67	0.67	0.67	N/A	1.00	1.00	1.00	1.00	N/A	0.33	0.67	0.729	

The scores written in red indicate when a culvert received a “Poor” or worse condition in one of the four critical categories. None of the culverts assessed during this project received a “Critical” grade in any category. The Excel file containing this data will also be included in the deliverable to the Town of Spencer. This will allow for rankings to be performed based on certain categories as well as encourage updates to the table as field conditions change over time.

4.5 Culvert Profiles

The end result of this project was a compilation of all data collected into a culvert profile that offers short and long term recommendations to the Town of Spencer. Each of the twenty-two culverts has a two page profile containing a structural assessment and aquatic passage score as well as traffic information and relevant field data. Culverts that had a “Poor” condition in one of the critical categories of the structural assessment, have that score written in red, to advise users that the score might not be as great as it appears. The profiles will allow the Town to compare short term and long term actions in an efficient and timely manner. The following pages contain the culvert profiles for twenty-two crossings in the Town of Spencer.

SPENCER

*Inlet Buried



NOTE ROAD CONDITION

Characteristic	Field Observation
Date observed	12/14/2014
Type	Embedded
Diameter	24"
Length	37'
Funding	Town
Stream Name (Tributary)	Unknown (Cranberry River)
Water Depth	20"
Outlet Drop	N/A

South Spencer Road: Culvert 1

Structural assessment results:
fair condition (0.46/1)

Aquatic assessment results:
moderate barrier (0.60/1)

Major Problems:

- Scouring and Erosion
- Clogging
- Low Flow
- Road Condition

Improvement Considerations

Short Term:

- Address clogging concerns

Long Term:

- Pipe replacement, road resurfacing

Relative Fill Needed :

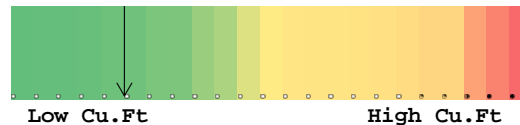

*ranked against observed culverts

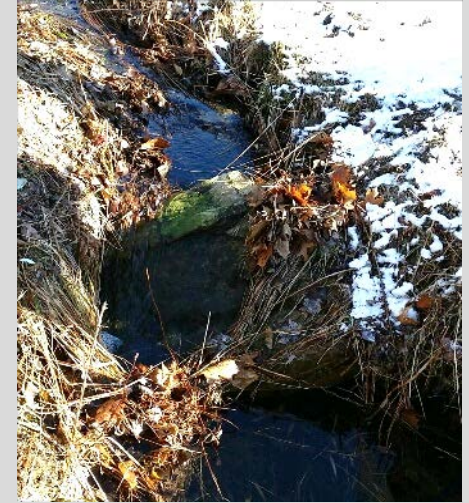

OUTLET

[FIELD NOTES]

- ❖ Inlet and outlet were almost completely submerged -> could lead to flooding especially with runoff
- ❖ Large rock blocking most of outlet
- ❖ Significant cracking through road above culvert

SPENCER



INLET

Characteristic	Field Observation
Date observed	12/14/2014
Type	Metal Pipe
Diameter	12"
Length	41'
Funding	Town
Stream Name (Tributary)	Unknown (Cranberry River)
Water Depth	1"
Outlet Drop	N/A

South Spencer Road: Culvert 2

Structural assessment results:
fair condition (0.63/1)

Aquatic assessment results:
significant barrier (0.50/1)

Major Problems:

- Scouring and Erosion
- Clogging
- Low Flow
- Road Condition

Improvement Considerations

Short Term:

- Address clogging concerns

Long Term:

- Pipe replacement
- Study flow/runoff patterns in area

Relative Fill Needed:

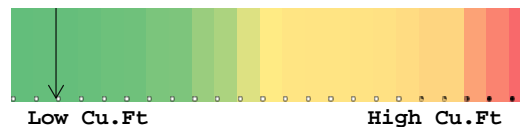

*ranked relatively against observed culverts



OUTLET

[FIELD NOTES]

- ❖ Seems to be used for storm runoff rather than a consistent stream flow
- ❖ Tree down right next to outlet

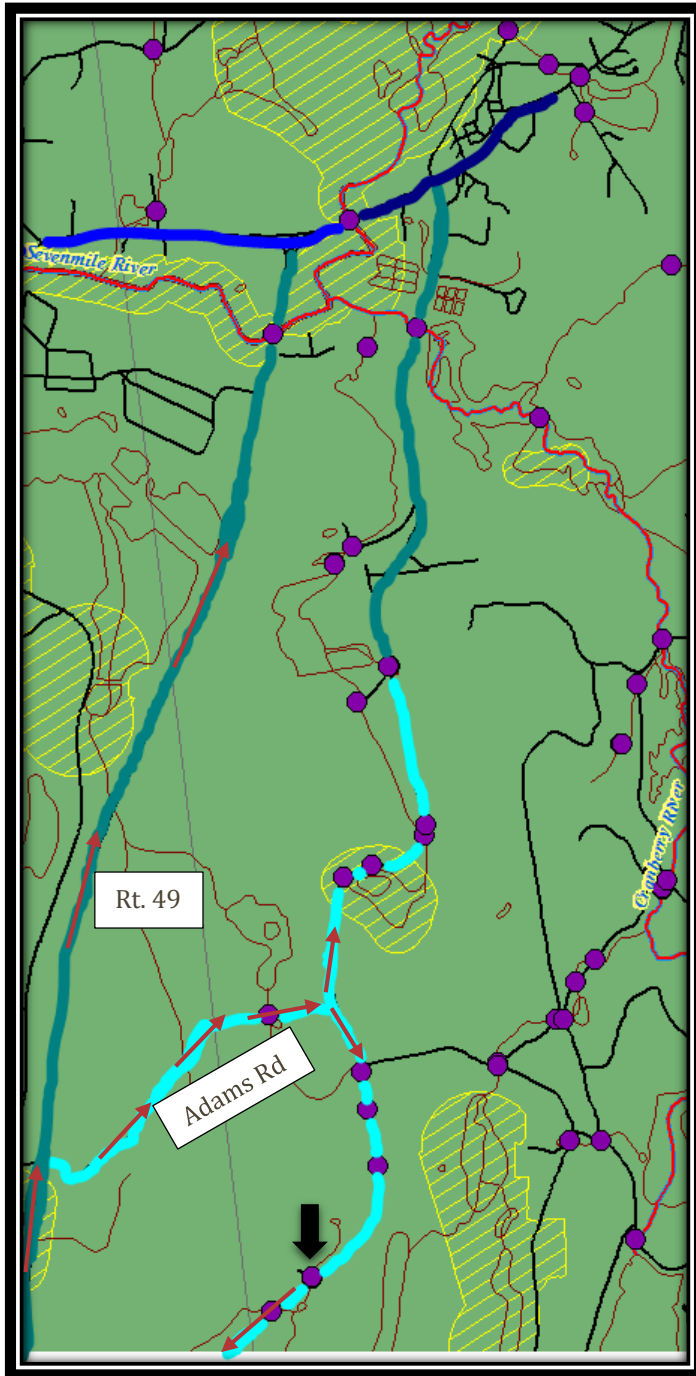

South Spencer Road 2

Impact

- ❖ The use of South Spencer Rd. decreases as you drive away from downtown Spencer. The road leads into rural terrain parallel to Rt. 49. This makes the detour around culvert reconstruction efficient. Traffic flow to Main St. in Spencer can be diverted to Rt. 49 and/or Adams Rd. back to South Spencer Rd.
- ❖ There has been no traffic count performed this far South on South Spencer Rd. Traffic flow is generally low in the area and the nearest priority habitat exists on the east side of South Spencer Rd.
- ❖ The aquatic wildlife in the area find rough passage along the road where the water is diverted in swales. Land adjacent to this section of the road is primarily used for rural residential and agricultural purposes.



WPI



SPENCER



INLET

Characteristic	Field Observation
Date observed	12/14/2014
Type	Metal Pipe
Diameter	14.5"
Length	34'
Funding	Town
Stream Name (Tributary)	Unknown (Cranberry River)
Water Depth	1.5"
Outlet Drop	2", Freefall

South Spencer Road: Culvert 3

Structural assessment results:
good condition (0.74/1)

Aquatic assessment results:
moderate barrier (0.60/1)

Major Problems:

- Scouring and Erosion
- Clogging
- Low Flow
- Road Condition

Improvement Considerations

Short Term:

- Address clogging concerns

Long Term:

- Pipe replacement, road resurfacing

Relative Fill Needed:

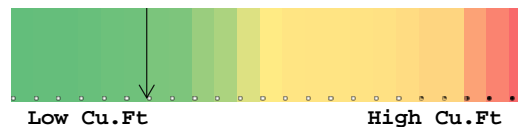

*ranked relatively against observed culverts



OUTLET

[FIELD NOTES]

- ❖ Natural debris clogging at inlet and outlet
- ❖ Strong sulfuric smell in area
- ❖ Cracking in road above culvert

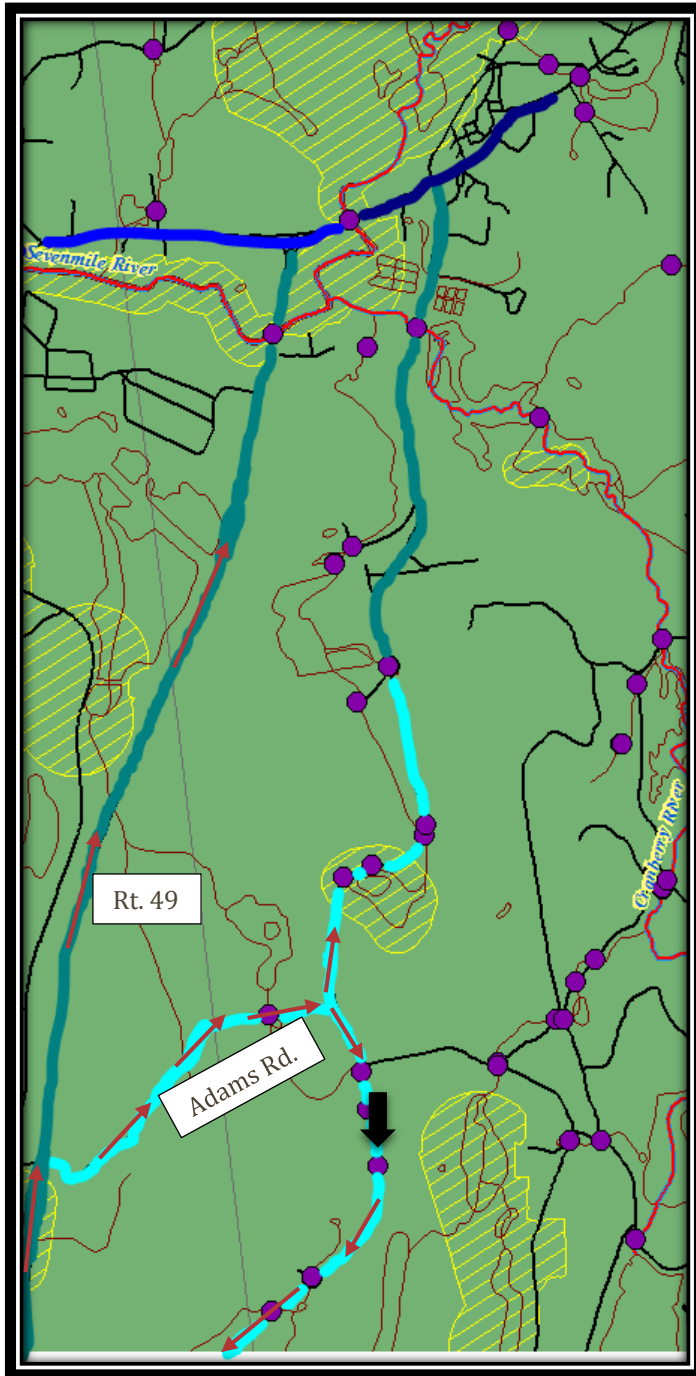

South Spencer Road 3

Impact

- ❖ The use of South Spencer Rd. decreases as you drive away from downtown Spencer. The road leads into rural terrain parallel to Rt. 49. This makes the detour around culvert reconstruction efficient. Traffic flow to Main St. in Spencer can be diverted to Rt. 49 and/or Adams Rd. back to South Spencer Rd.
- ❖ There has been no traffic count performed this far South on South Spencer Rd. Traffic flow is generally low in the area and the nearest priority habitat exists on the east side of South Spencer Rd.
- ❖ The aquatic wildlife in the area find rough passage along the road where the water is diverted in swales. Land adjacent to this section of the road is primarily used for rural residential and agricultural purposes.



WPI



SPENCER



INLET

Characteristic	Field Observation
Date observed	12/14/2014
Type	Concrete Pipe
Diameter	14.5"
Length	34'
Funding	Town
Stream Name (Tributary)	Unknown (Cranberry River)
Water Depth	3"
Outlet Drop	2", Cascade

South Spencer Road: Culvert 4

Structural assessment results:
good condition (0.76*/1)

Aquatic assessment results:
moderate barrier (0.70/1)

Major Problems:

- * Headwall
- Clogging
- Erosion
- Low Flow

Improvement Considerations

Short Term:

- Address clogging concerns

Long Term:

- Continued maintenance

Relative Fill Needed:

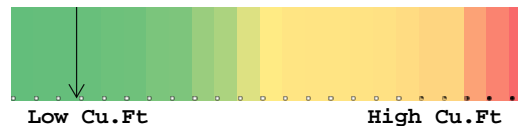

*ranked relatively against observed culverts



OUTLET

[FIELD NOTES]

- ❖ Headwall is in poor condition
- ❖ Road was recently paved above culvert

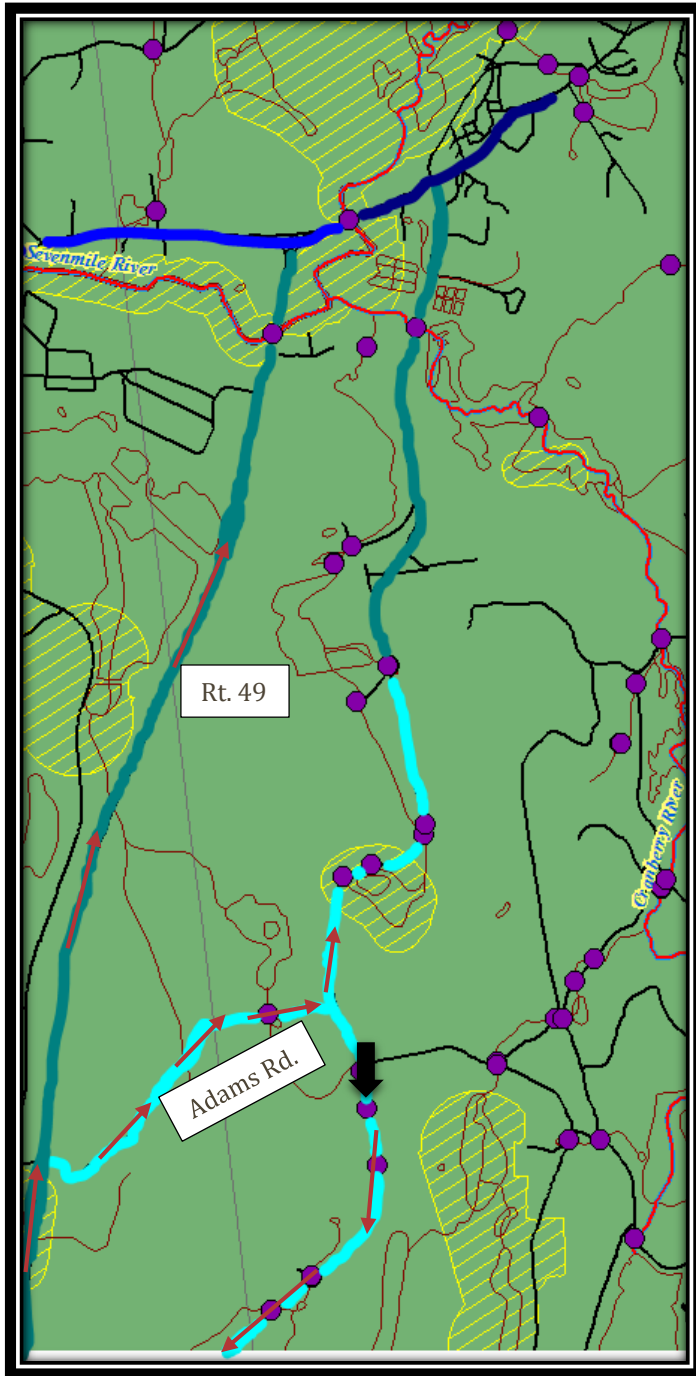

South Spencer Road 4

Impact

- ❖ The use of South Spencer Rd. decreases as you drive away from downtown Spencer. The road leads into rural terrain parallel to Rt. 49. This makes the detour around culvert reconstruction efficient. Traffic flow to Main St. in Spencer can be diverted to Rt. 49 and/or Adams Rd. back to South Spencer Rd.
- ❖ There has been no traffic count performed this far South on South Spencer Rd. Traffic flow is generally low in the area and the nearest priority habitat exists on the east side of South Spencer Rd.
- ❖ The aquatic wildlife in the area find rough passage along the road where the water is diverted in swales. Land adjacent to this section of the road is primarily used for rural residential and agricultural purposes.



WPI



SPENCER



INLET

Characteristic	Field Observation
Date observed	12/14/2014
Type	Concrete/Metal Pipe
Diameter	20"
Length	33'
Funding	Town
Stream Name (Tributary)	Unknown (Cranberry River)
Water Depth	13"
Outlet Drop	6", Freefall

South Spencer Road: Culvert 5

Structural assessment results:
fair condition (0.60*/1)

Aquatic assessment results:
moderate barrier (0.60/1)

Major Problems:

- * **Cracking**
 - Culvert split in two pieces
 - Scouring/Erosion
 - Ponding

Improvement Considerations

Short Term:

- Routine tracking of integrity of culvert/road

Long Term:

- Pipe replacement

Relative Fill Needed:

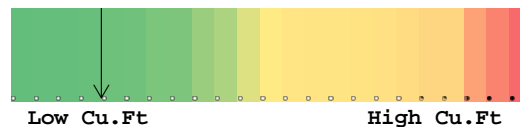

*ranked relatively against observed culverts



OUTLET

[FIELD NOTES]

- ❖ Half the road is recently paved above culvert
- ❖ Concrete pipe at inlet and metal pipe at outlet
- ❖ Stream flow internally cascades from one half to the other

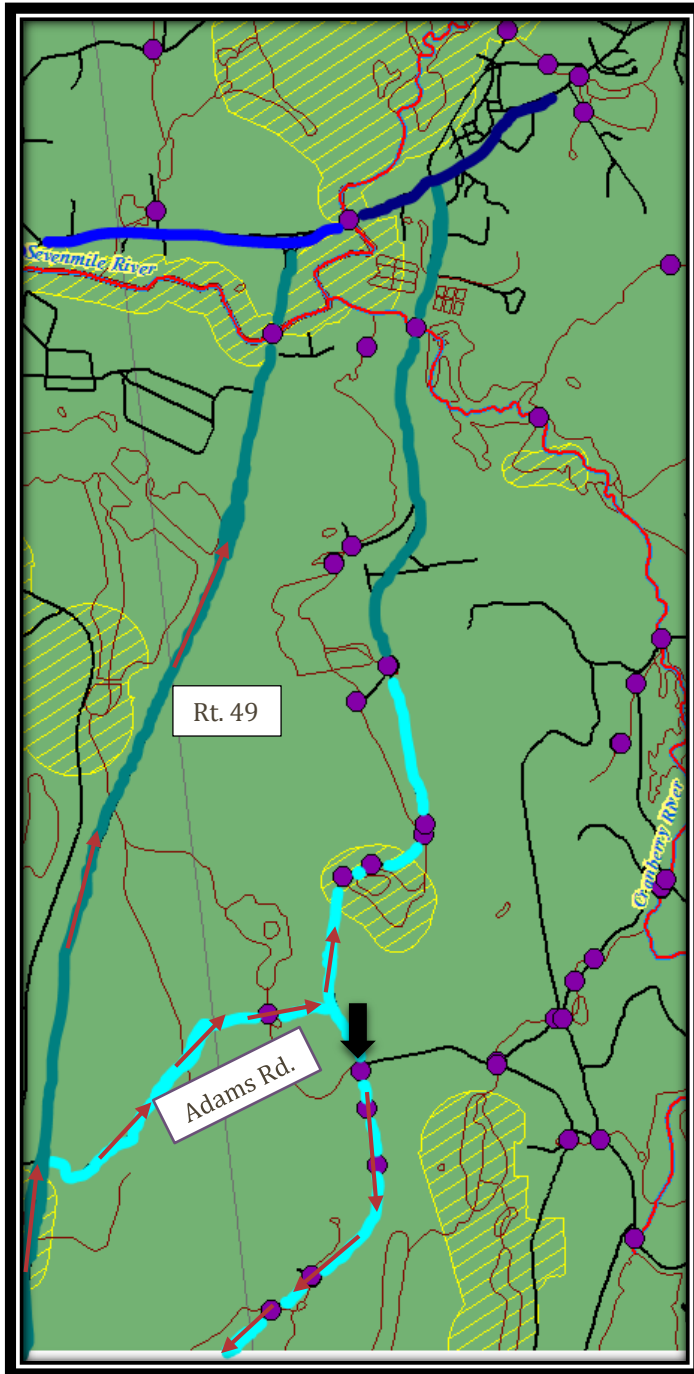

South Spencer Road 5

Impact

- ❖ The use of South Spencer Rd. decreases as you drive away from downtown Spencer. The road leads into rural terrain parallel to Rt. 49. This makes the detour around culvert reconstruction efficient. Traffic flow to Main St. in Spencer can be diverted to Rt. 49 and/or Adams Rd. back to South Spencer Rd.
- ❖ There has been no traffic count performed this far South on South Spencer Rd. Traffic flow is generally low in the area and the nearest priority habitat exists on the east side of South Spencer Rd.
- ❖ The aquatic wildlife in the area find rough passage along the road where the water is diverted in swales. Land adjacent to this section of the road is primarily used for rural residential and agricultural purposes.



WPI



SPENCER



INLET

Characteristic	Field Observation
Date observed	12/14/2014
Type	Masonry Box
Height x Width	24" x 24"
Length	32'
Funding	Town
Stream Name (Tributary)	Unknown Bog (Cranberry River)
Water Depth	16"
Outlet Drop	N/A

South Spencer Road: Culvert 6

Structural assessment results:
fair condition (0.62*/1)

Aquatic assessment results:
minor barrier (0.80/1)

Major Problems:

- * Scouring/Erosion
- Ponding
- Not enough capacity
- Debris

Improvement Considerations

Short Term:

- Remove debris

Long Term:

- Box replacement (more capacity)

Relative Fill Needed:

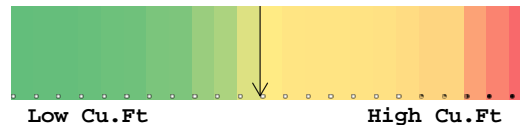

*ranked relatively against observed culverts



OUTLET

[FIELD NOTES]

- ❖ Chain link fence about 5' in front of inlet
- ❖ Bog being filled by underground tributaries
- ❖ Inlet and outlet are almost submerged
- ❖ Large amount of scour on outlet side

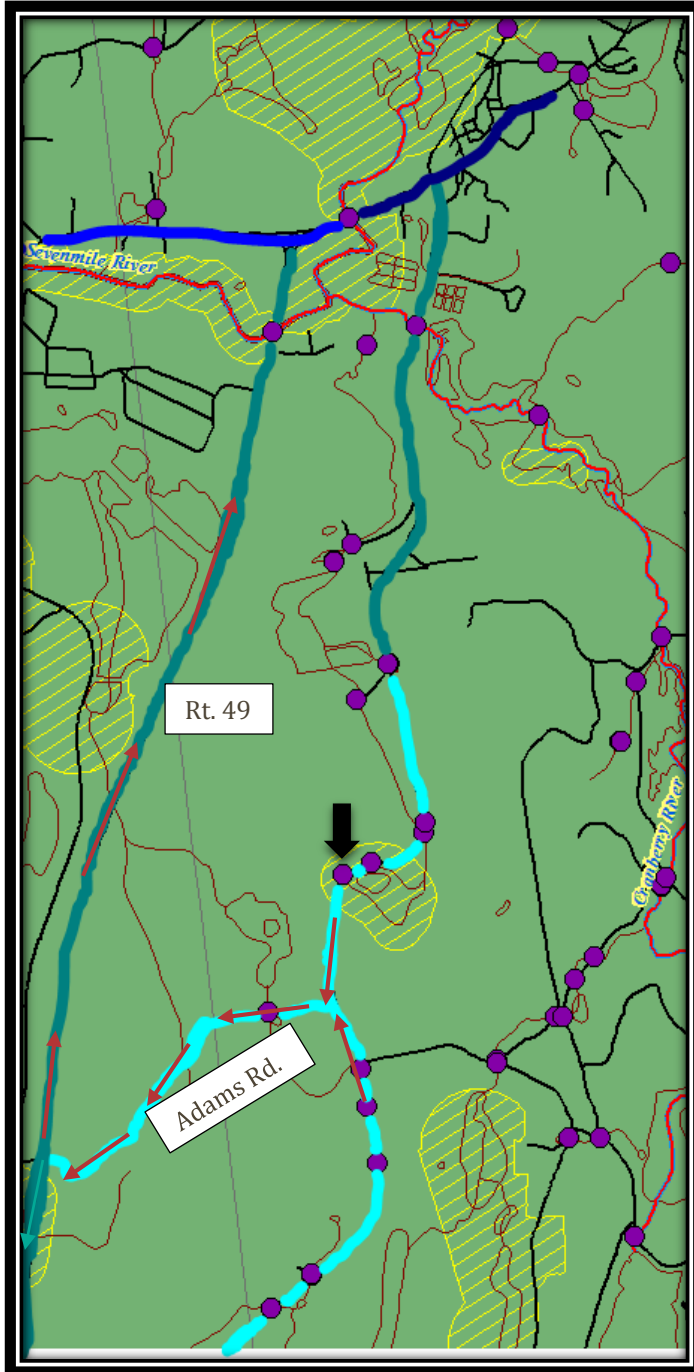

South Spencer Road 6

Impact

- ❖ The use of South Spencer Rd. decreases as you drive away from downtown Spencer. The road leads into rural terrain parallel to Rt. 49. This makes the detour around culvert reconstruction efficient. Traffic flow to Main St. in Spencer can be diverted to Rt. 49 and/or Adams Rd. back to South Spencer Rd.
- ❖ The estimated ADT is determined to be +/-2000 by CMRPC.
- ❖ This area is made up of a wetland, a priority habitat, and several runoff streams. The bog has a heavy presence of beavers. Because of the size of the bog and potential for runoff, the road is threatened by floods.



WPI



SPENCER



INLET

Characteristic	Field Observation
Date observed	12/14/2014
Type	Metal Pipe
Diameter	12"
Length	32'
Funding	Town
Stream Name (Tributary)	Unknown Bog (Cranberry River)
Water Depth	1"
Outlet Drop	N/A

South Spencer Road: Culvert 7

Structural assessment results:
fair condition (0.60/1)

Aquatic assessment results:
moderate barrier (0.60/1)

Major Problems:

- Scouring/Erosion
- Low Flow
- Clogging
- Debris

Improvement Considerations

Short Term:

- Remove debris

Long Term:

- Pipe replacement

Relative Fill Needed:

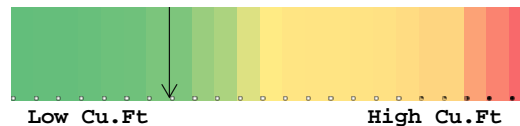

*ranked relatively against observed culverts

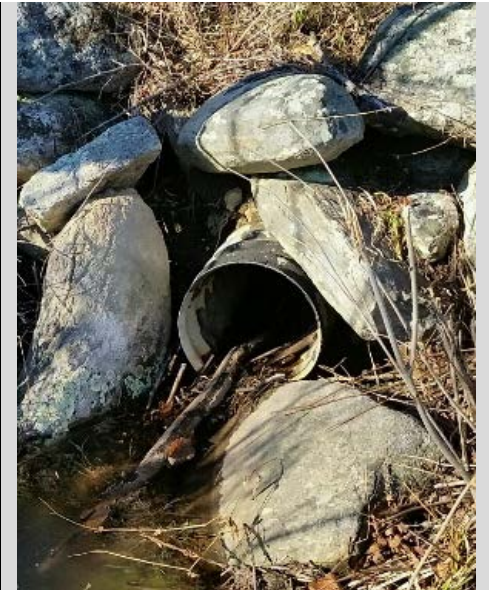

OUTLET

[FIELD NOTES]

- ❖ Bog being filled by underground tributaries
- ❖ Both inlet and outlet are surrounded by debris
- ❖ Underground stream feeding inlet from both directions

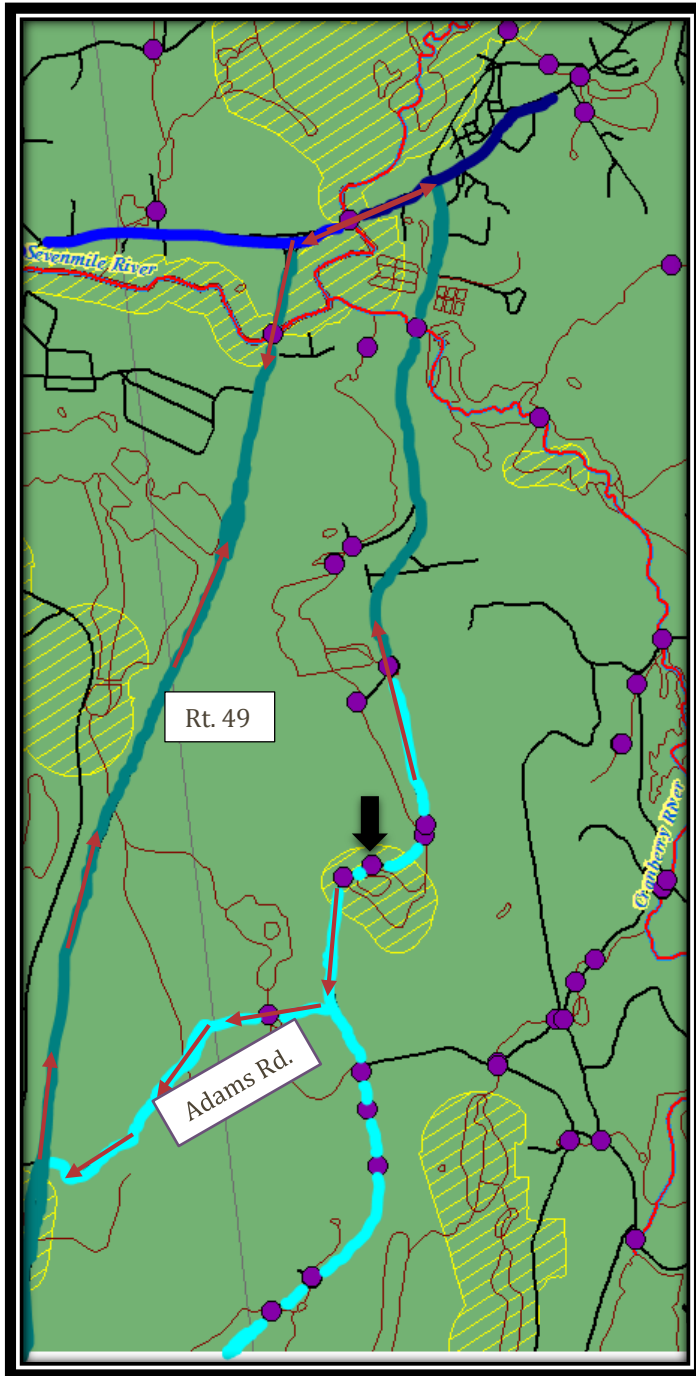

South Spencer Road 7

Impact

- ❖ The use of South Spencer Rd. decreases as you drive away from downtown Spencer. The road leads into rural terrain parallel to Rt. 49. This makes the detour around culvert reconstruction efficient. Traffic flow to Main St. in Spencer can be diverted to Rt. 49 and/or Adams Rd. back to South Spencer Rd.
- ❖ The estimated ADT is determined to be +/-2000 by CMRPC.
- ❖ This area is made up of a wetland, a priority habitat, and several runoff streams. The bog has a heavy presence of beavers. Because of the size of the bog and potential for runoff, the road is threatened by floods.



WPI



SPENCER



INLET

Characteristic	Field Observation
Date observed	12/14/2014
Type	Masonry
Length x Width	24" x 18"
Length	32'
Funding	Town
Stream Name (Tributary)	Unknown (Cranberry River)
Water Depth	6"
Outlet Drop	N/A

South Spencer Road: Culvert 8

Structural assessment results:
fair condition (0.50/1)

Aquatic assessment results:
minor barrier (0.70/1)

Major Problems:

- Scouring/Erosion
- Low Flow
- Clogging
- Debris

Improvement Considerations

Short Term:

- Remove debris

Long Term:

- Install pipe or
- Retrofit masonry structure

Relative Fill Needed:

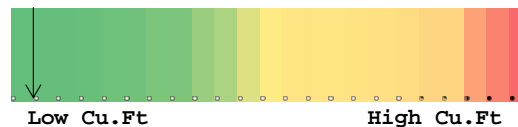

*ranked relatively against observed culverts

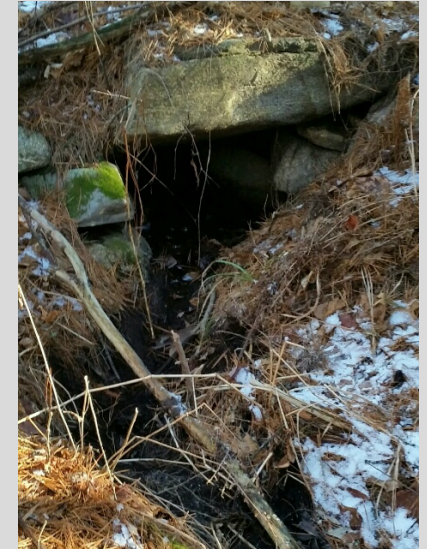

OUTLET

[FIELD NOTES]

- ❖ Significant pothole on road above crossing
- ❖ Stream goes underground after outlet for about 5 ft. then resurfaces and leads to a wetland

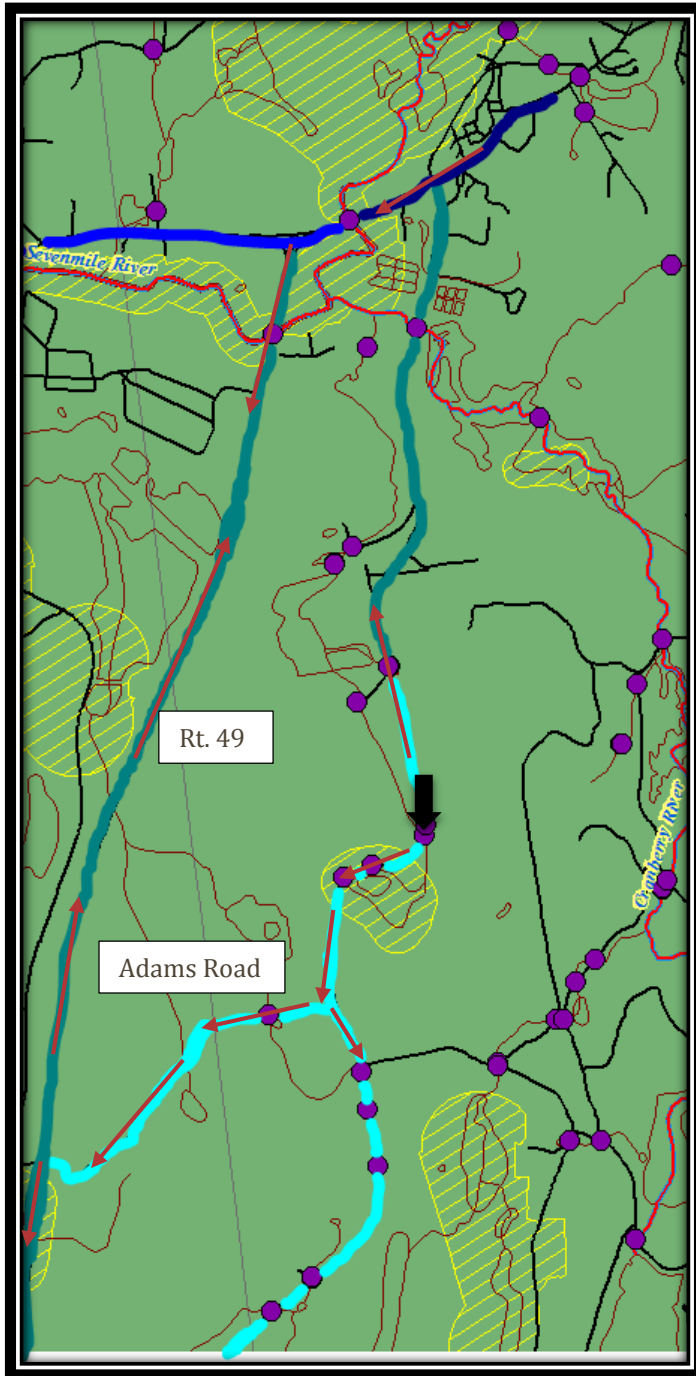

South Spencer Road 8

Impact

- ❖ The use of South Spencer Rd. decreases as you drive away from downtown Spencer. The road leads into rural terrain parallel to Rt. 49. This makes the detour around culvert reconstruction efficient. Traffic flow to Main St. in Spencer can be diverted to Rt. 49 and/or Adams Rd. back to South Spencer Rd.
- ❖ The estimated ADT is determined to be +/-2000 by CMRPC.



WPI



SPENCER



INLET

Characteristic	Field Observation
Date observed	12/14/2014
Type	Metal Pipe
Diameter	15.5"
Length	34'
Funding	Town
Stream Name (Tributary)	Unknown (Cranberry River)
Water Depth	4"
Outlet Drop	7", Freefall

South Spencer Road: Culvert 9

Structural assessment results:
good condition (0.79/1)

Aquatic assessment results:
moderate barrier (0.60/1)

Major Problems:

- Minor Scouring
- Debris

Improvement Considerations

Short Term:

- Remove debris

Long Term:

- Retrofit pipe to match stream slope

Relative Fill Needed:



*ranked relatively against observed culverts



OUTLET

[FIELD NOTES]

- ❖ About 50 ft. from outlet stream becomes a wetland area
- ❖ Multiple hydraulic jumps within first 20 ft. downstream
- ❖ Rocks and debris gathering at inlet

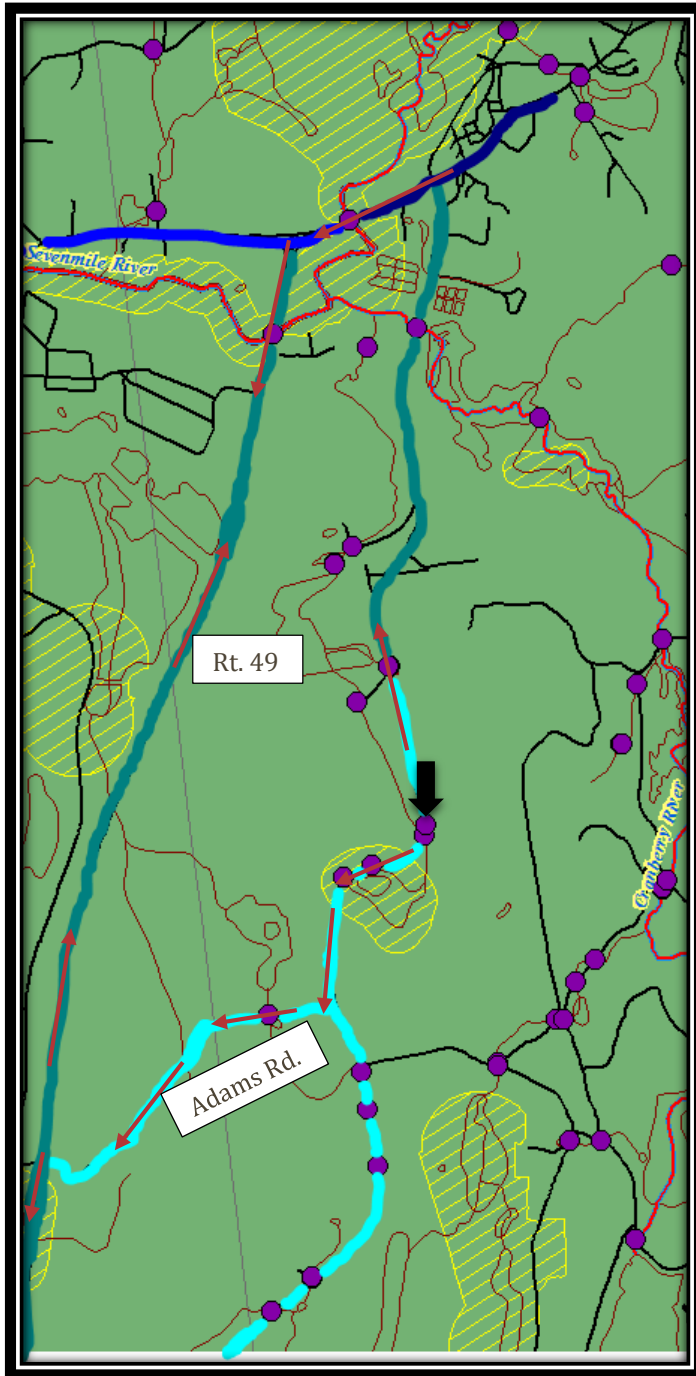

South Spencer Road 9

Impact

- ❖ The use of South Spencer Rd. decreases as you drive away from downtown Spencer. The road leads into rural terrain parallel to Rt. 49. This makes the detour around culvert reconstruction efficient. Traffic flow to Main St. in Spencer can be diverted to Rt. 49 and/or Adams Rd. back to South Spencer Rd.
- ❖ The estimated ADT is determined to be +/-2000 by CMRPC.



WPI



SPENCER



INLET

Characteristic	Field Observation
Date observed	12/14/2014
Type	Dam/Metal Pipe
Diameter	14.5"
Length	43'
Funding	Town
Stream Name (Tributary)	Unknown (Cranberry River)
Water Depth	1"
Outlet Drop	2", Freefall onto Cascade

South Spencer Road: Culvert 10

Structural assessment results:
good condition (0.76/1)

Aquatic assessment results:
moderate barrier (0.70/1)

Major Problems:

- Debris

Improvement Considerations

Short Term:

- Watch pond depth and outlet flow

Long Term:

- N/A

Relative Fill Needed:

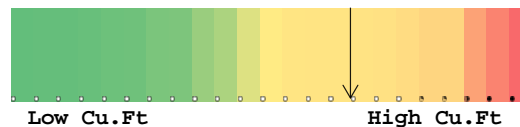

*ranked relatively against observed culverts

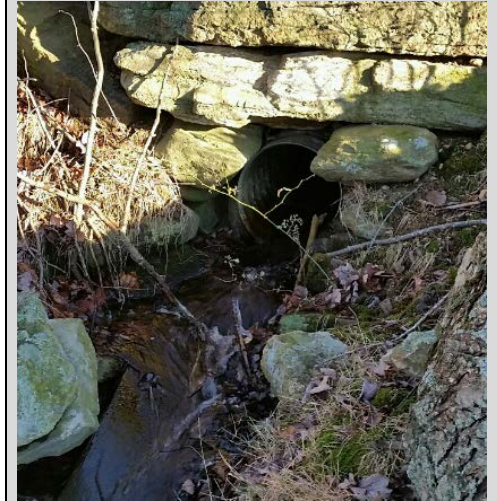

OUTLET

[FIELD NOTES]

- ❖ Inlet is a rectangular dam
- ❖ Fish passage here is impossible as stream ends at horse farm on West side

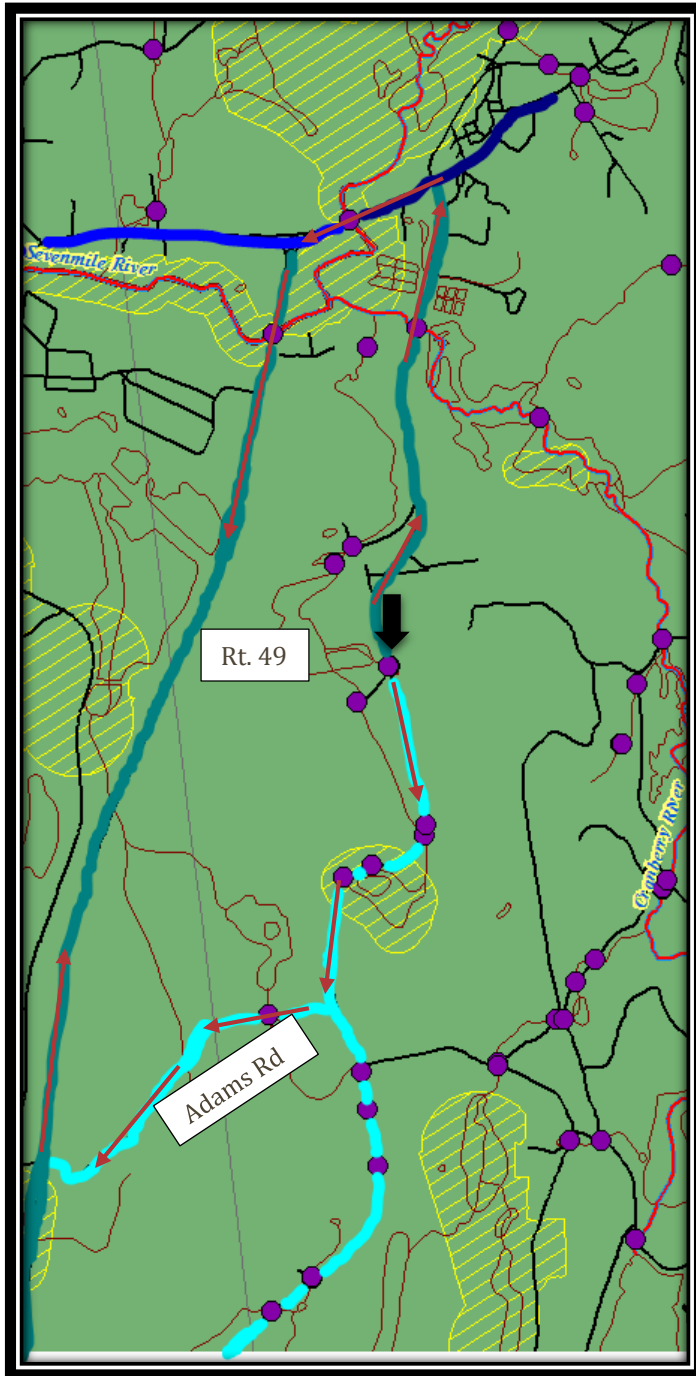

South Spencer Road 10

Impact

- ❖ The use of South Spencer Rd. decreases as you drive away from downtown Spencer. The road leads into rural terrain parallel to Rt. 49. This makes the detour around culvert reconstruction efficient. Traffic flow to Main St. in Spencer can be diverted to Rt. 49 and/or Adams Rd. back to South Spencer Rd.
- ❖ The section of road leading to the culvert has an estimated ADT of +2500. Nearby residents would have their daily routines impeded upon.
- ❖ The crossing works as a dam and holds a manmade pond on the East side of the road.



WPI



SPENCER



INLET

Characteristic	Field Observation
Date observed	12/14/2014
Type	Open-Bottom Box
Width x Height	12' x 5' 6"
Length	27'
Funding	Town
Stream Name (Tributary)	Cranberry River
Water Depth	18"
Outlet Drop	N/A

South Spencer Road: Culvert 11

Structural assessment results:
good condition (0.84/1)

Aquatic assessment results:
minor barrier (0.80/1)

Major Problems:

- Contrasting structure substrate
- Minor scouring

Improvement Considerations

Short Term:

- Watch scouring/erosion

Long Term:

- Continue routine structural assessments

Relative Fill Needed:

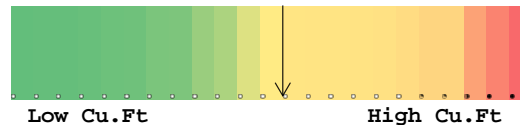

*ranked relatively against observed culverts



OUTLET

[FIELD NOTES]

- ❖ Built in 1938
- ❖ Bridge No. – S-23-019
- ❖ Small scour pool at outlet

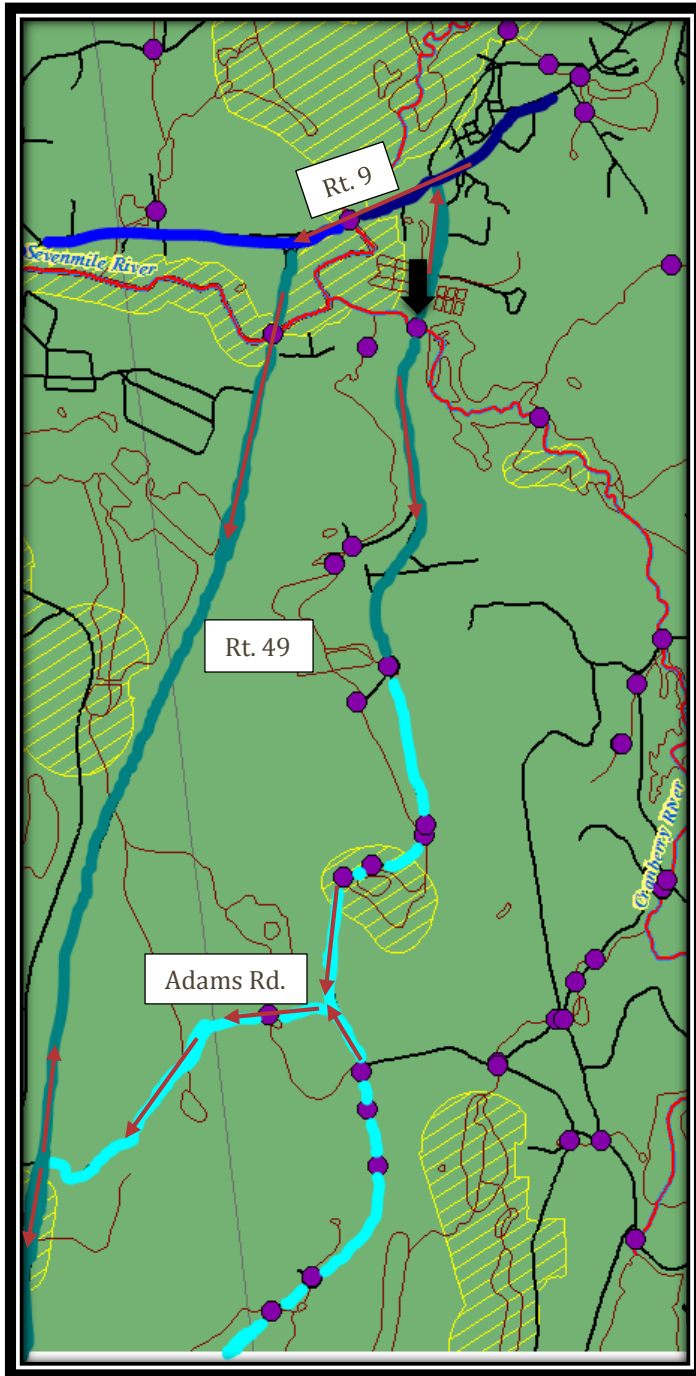

South Spencer Road 11

Impact

- ❖ The use of South Spencer Rd. decreases as you drive away from downtown Spencer. The road leads into rural terrain parallel to Rt. 49. This makes the detour away from culvert reconstruction efficient. Detour for traffic towards the local area becomes difficult diverting to Rt. 49. Time spent on avoiding construction could be +10 minutes to destination.
- ❖ The section of road leading to the culvert has an estimated ADT of +2500.
- ❖ AASHTO rating of 33.



WPI



S P E N C E R



INLET

Characteristic	Field Observation
Date observed	12/14/2014
Type	Box
Width x Height	12' x 6' 7"
Length	68'
Funding	MassDOT
Stream Name (Tributary)	Muzzy Brook
Water Depth	12"
Outlet Drop	N/A

West Main St. (Rt. 9): Culvert 1

Structural assessment results:
good condition (0.80/1)

Aquatic assessment results:
moderate barrier (0.60/1)

Major Problems:

- Minor scouring
- Damming at inlet

Improvement Considerations

Short Term:

- Address dam at inlet, open up larger passage
- Check water quality

Long Term:

- Continue routine structural assessments

Relative Fill Needed:

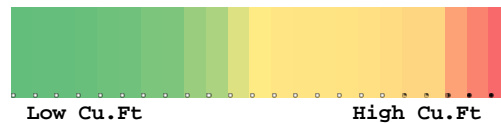

*ranked relatively against observed culverts



OUTLET

[FIELD NOTES]

- ❖ Built in 1956
- ❖ Bridge No. – S-23-022
- ❖ Large wetland area on inlet side
- ❖ Beaver dam at inlet creating fast waterfall (restricted fish passage)
- ❖ Runoff pipe contributing to stream on outlet side
- ❖ Sulfur-like smell in area

Impact

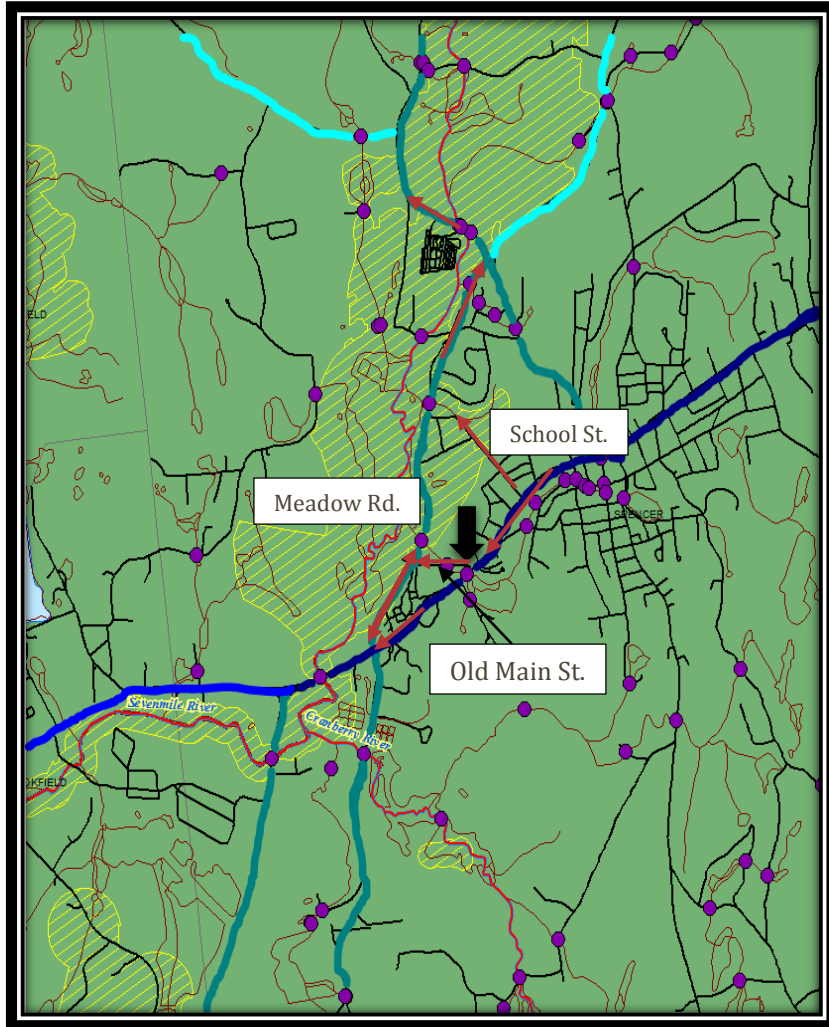

West Main Street 1

- ❖ The use of West Main St. in Spencer has been increasing according to MassDOT. There are multiple detours available to avoid any necessary work. The use of Old Main St or School St. could slow the traffic flow down but be used as a minor detour.
- ❖ The ADT of this section of Rt 9 was counted at +18,000 by MassDOT.
- ❖ The culvert is in good condition but environmental complications are evident. Muzzy Brook is dammed on the South side of the road by a beaver. There is evidence of turbidity and nutrients in the water.
- ❖ AASHTO rating of 38.8.



S P E N C E R



INLET

Characteristic	Field Observation
Date observed	11/22/2014
Type	Double Pipe
Diameter	48"
Length	44'
Funding	Town
Stream Name (Tributary)	Muzzy Brook
Water Depth	18"
Outlet Drop	N/A

Meadow Road: Culvert 1

Structural assessment results:
good condition (0.89/1)

Aquatic assessment results:
moderate barrier (0.70/1)

Major Problems:

- Erosion/scouring

Improvement Considerations

Short Term:

- Address scouring on outlet side

Long Term:

- Box replacement

Relative Fill Needed:

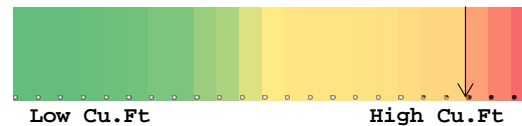

*ranked relatively against observed culverts



OUTLET

[FIELD NOTES]

- ❖ Large scour pool on outlet side
- ❖ Small scouring at inlet
- ❖ Culvert constricts stream natural bank width

Impact

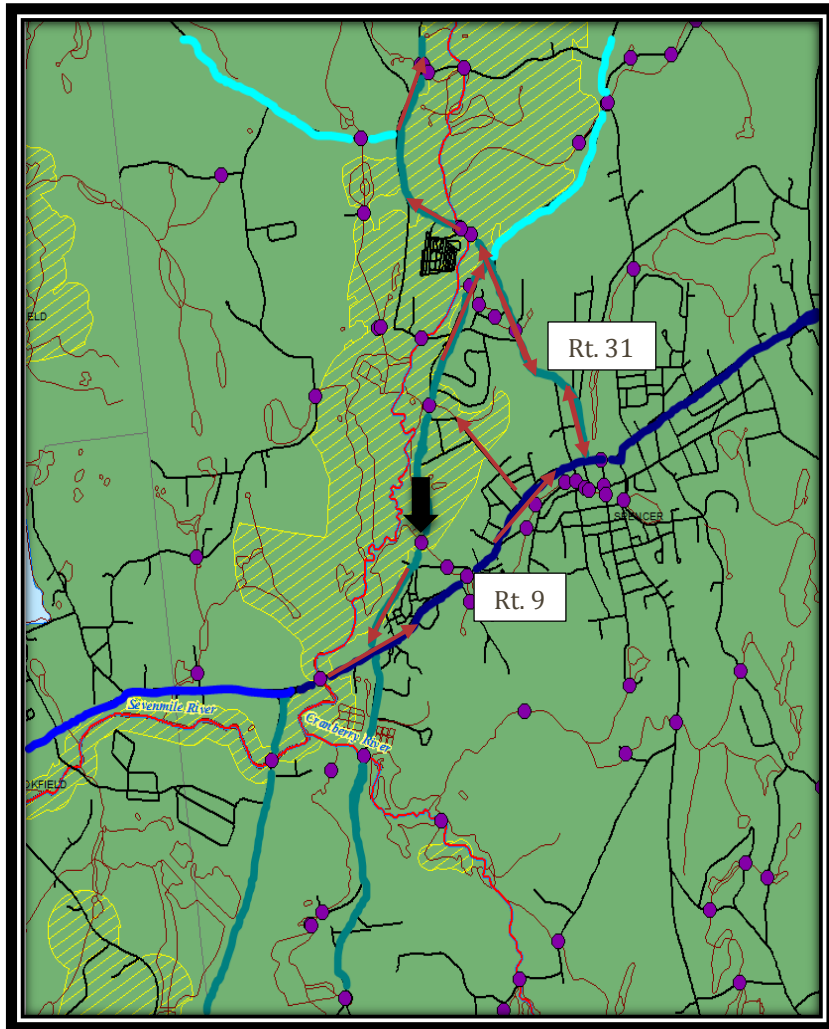

Meadow Road 1

- ❖ Meadow Rd. is a highly depended upon collector road leading from Rt. 9 to Rt. 31, the major arterial roads running through Spencer. According to CMRPC's latest traffic counts (5/24/13) the ADT is +/- 4500 with little variance between NB and SB.
- ❖ The peak hours calculated were 7 a.m. and 5 p.m. and the count shows consistent traffic during business hours. Construction on a culvert on Meadow Rd. will ultimately take away a time saving route for commuters from the West (Brookfield, East Brookfield, Warren...) to their destination in the North (Paxton, Oakham...) or vice versa.
- ❖ Depending on conditions of downtown Spencer the nearest detour doubles the time that would be spent on Meadow Rd.



WPI



S P E N C E R



INLET

Characteristic	Field Observation
Date observed	12/18/2014
Type	Concrete Pipe
Diameter	36"
Length	60'
Funding	Town
Stream Name (Tributary)	unknown
Water Depth	22"
Outlet Drop	N/A

Meadow Road: Culvert 2

Structural assessment results:
fair condition (0.63/1)

Aquatic assessment results:
minor barrier (0.80/1)

Major Problems:

- Scouring and Erosion
- Road Condition
- Submerged Outlet

Improvement Considerations

Short Term:

- Watch for flooding in area

Long Term:

- Box replacement

Relative Fill Needed:

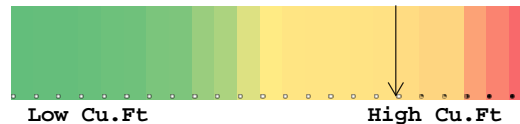

*ranked relatively against observed culverts



OUTLET

[FIELD NOTES]

- ❖ Lots of litter in area
- ❖ Outlet is almost submerged
- ❖ Water is very deep and widening outlet area
- ❖ Turns into wetland area downstream

Impact

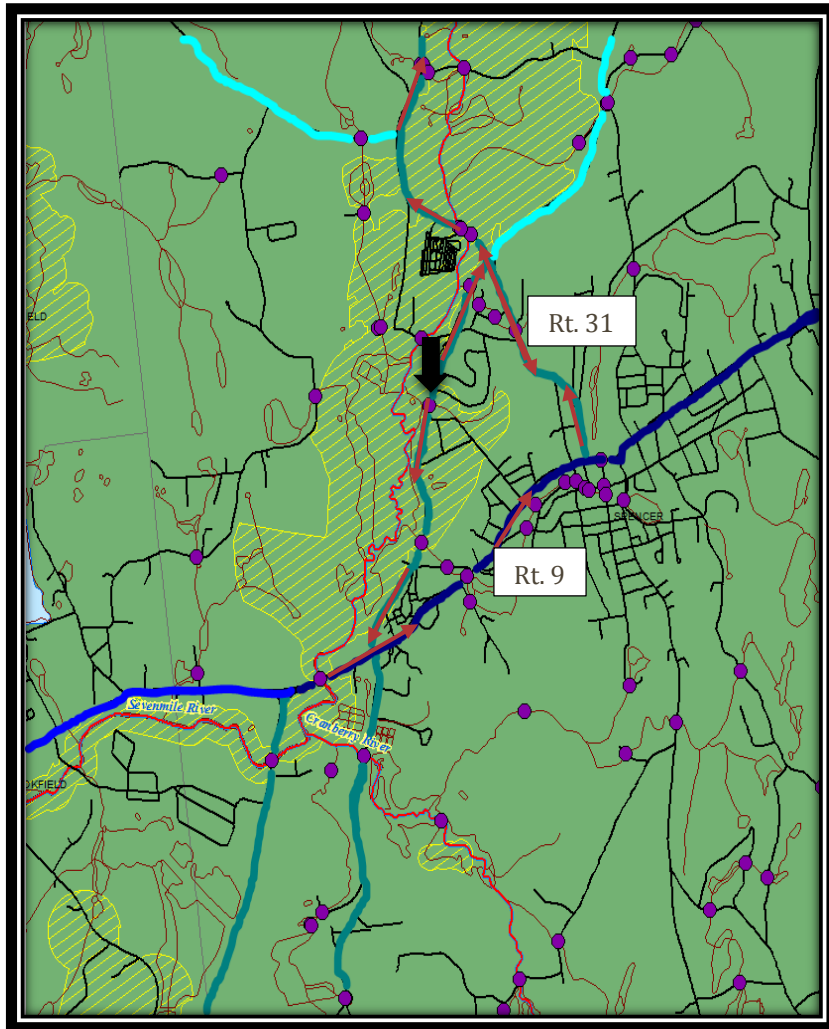

Meadow Road 2

- ❖ Meadow Rd. is a highly depended upon collector road leading from Rt. 9 to Rt. 31, the major arterial roads running through Spencer. According to CMRPC's latest traffic counts (5/24/13) the ADT is +/- 4500 with little variance between NB and SB.
- ❖ The peak hours calculated were 7 a.m. and 5 p.m. and the count shows consistent traffic during business hours. Construction on a culvert on Meadow Rd. will ultimately take away a time saving route for commuters from the West (Brookfield, East Brookfield, Warren...) to their destination in the North (Paxton, Oakham...) or vice versa.
- ❖ Depending on conditions of downtown Spencer the nearest detour doubles the time that would be spent on Meadow Rd.



WPI



SPENCER



INLET

Characteristic	Field Observation
Date observed	12/18/2014
Type	Open-Bottom Box
Length x Width	45' x 12'
Length	32'
Funding	MassDOT
Stream Name (Tributary)	Seven Mile River
Water Depth	24"
Outlet Drop	N/A

North Spencer Rd. (Rt.31): Culvert 1

Structural assessment results:
good condition (0.71*/1)

Aquatic assessment results:
insignificant barrier (1/1)

Major Problems:

- * **Scouring and Erosion**

Improvement Considerations

Short Term:

- N/A

Long Term:

- Continue routine structural assessments
- Watch scouring patterns

Relative Fill Needed:

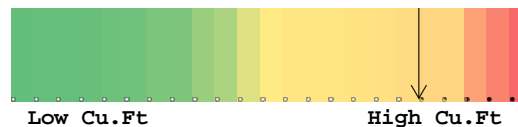

*ranked relatively against observed culverts



OUTLET

[FIELD NOTES]

- ❖ Built in 1952
- ❖ Bridge No. – S-23-002
- ❖ Scour pools developing at inlet
- ❖ Mild constriction of river

Impact

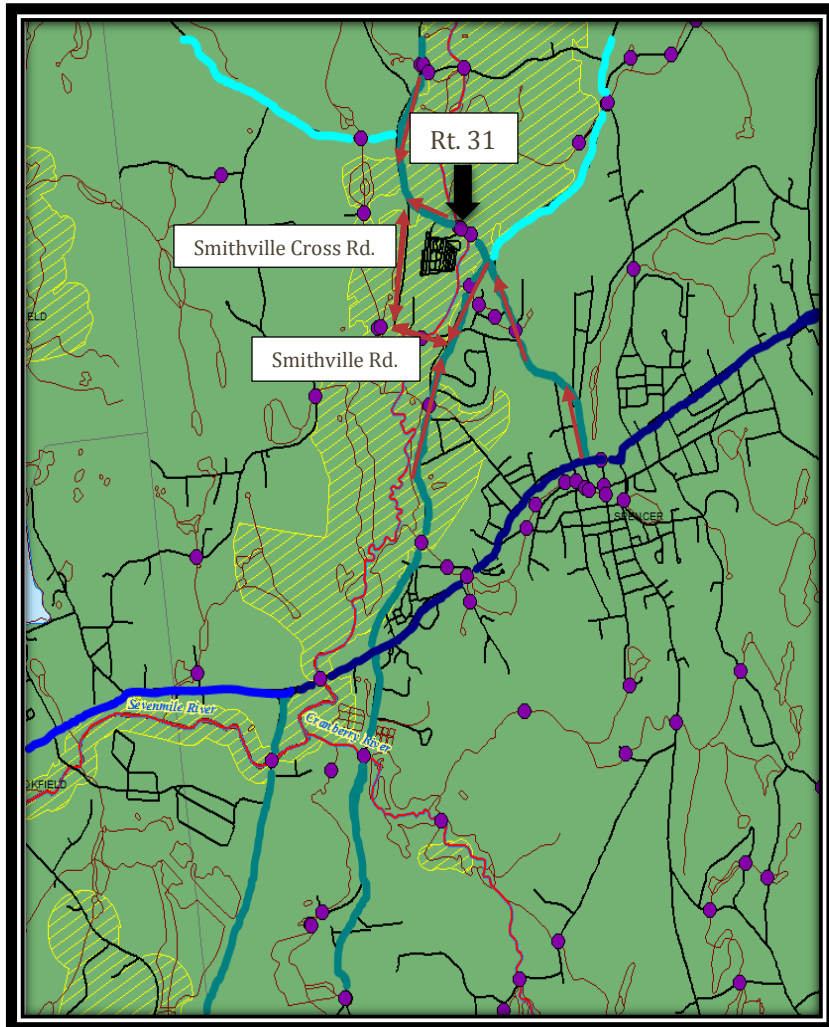

North Spencer Road 1

- ❖ MassDOT last recorded the ADT of this section of Rt. 31 at +7500. The most convenient detour would include multiple roads, leading West on Smithville Cross Rd. to Smithville Rd.
- ❖ The span of the bridge may have originally been similar to the dimensions of the bank. Scouring has continued to widen and deepen this bend in the river underneath North Spencer Road.
- ❖ AASHTO rating of 53.2



WPI



SPENCER



INLET

Characteristic	Field Observation
Date observed	12/18/2014
Type	Concrete Pipe
Diameter	24"
Length	31'
Funding	Town
Stream Name (Tributary)	unknown (Seven Mile River)
Water Depth	10"
Outlet Drop	N/A

North Spencer Rd. (Rt.31): Culvert 2

Structural assessment results:
good condition (0.78/1)

Aquatic assessment results:
moderate barrier (0.70/1)

Major Problems:

- Scouring and Erosion

Improvement Considerations

Short Term:

- N/A

Long Term:

- Watch scouring patterns

Relative Fill Needed:

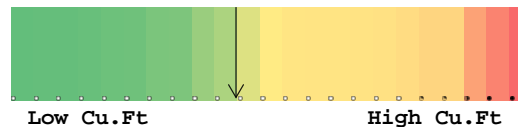

*ranked relatively against observed culverts



OUTLET

[FIELD NOTES]

- ❖ Off to the side of Rt. 31 with lawn separating road and second culvert in system
- ❖ Approx. 10 ft. open gap between road crossing and this culvert
- ❖ Large scouring at outlet

Impact

- ❖ This culvert does not cross underneath road
- ❖ The reconstruction of this system may require attention to the culvert on Cooney Rd. that crosses the same stream.

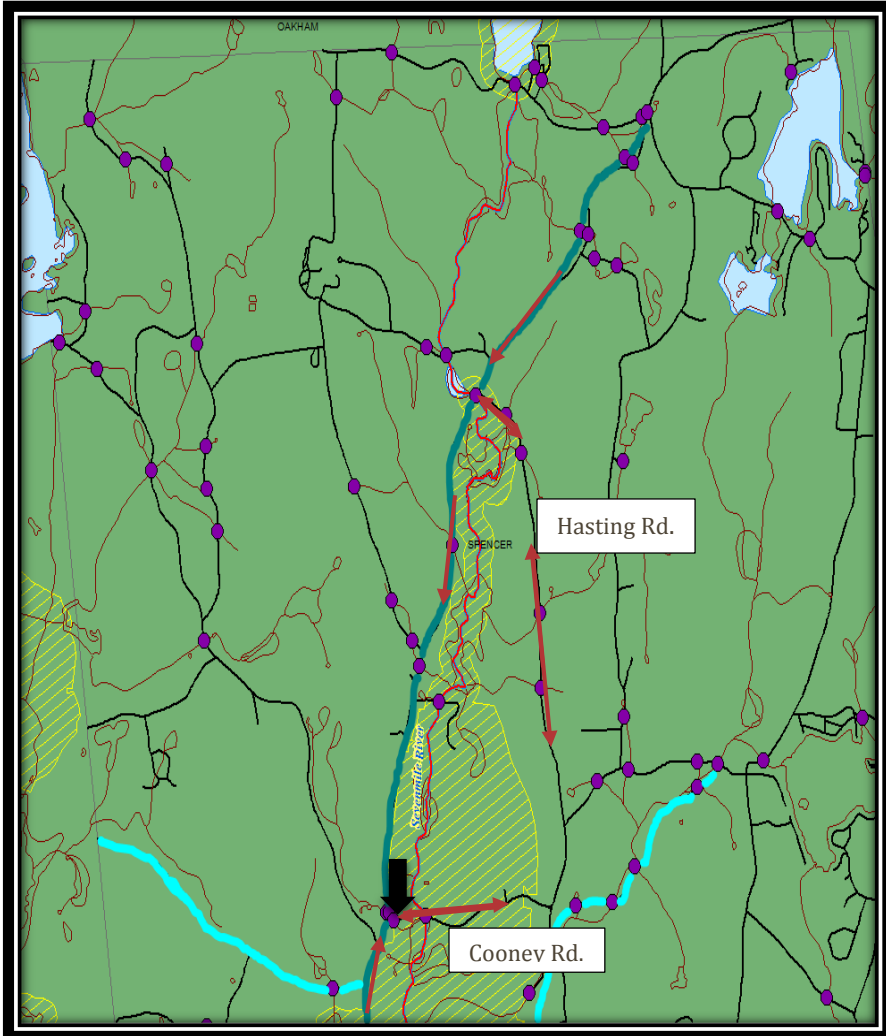

North Spencer Road 2



S P E N C E R



INLET

Characteristic	Field Observation
Date observed	12/18/2014
Type	Concrete Pipe
Diameter	24"
Length	40'
Funding	Town
Stream Name (Tributary)	unknown (Seven Mile River)
Water Depth	2"
Outlet Drop	10", Freefall

North Spencer Rd. (Rt.31): Culvert 3

Structural assessment results:
good condition (0.77*/1)

Aquatic assessment results:
significant barrier (0.50/1)

Major Problems:

- * **Headwall**
 - Scouring and Erosion
 - Debris

Improvement Considerations

Short Term:

- Address debris at inlet

Long Term:

- Routine assessments
- Ensure no further erosion in pool between the two culverts

Relative Fill Needed:

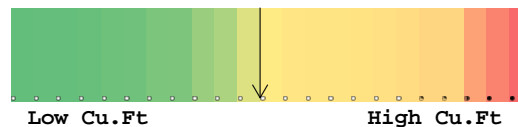

*ranked relatively against observed culverts



OUTLET

[FIELD NOTES]

- ❖ Headwall is in poor condition
- ❖ Multiple hydraulic jumps within 30 ft. upstream
- ❖ Mild constriction of stream
- ❖ Leads into pool separating this culvert from North Meadow Rd Culvert 2

Impact

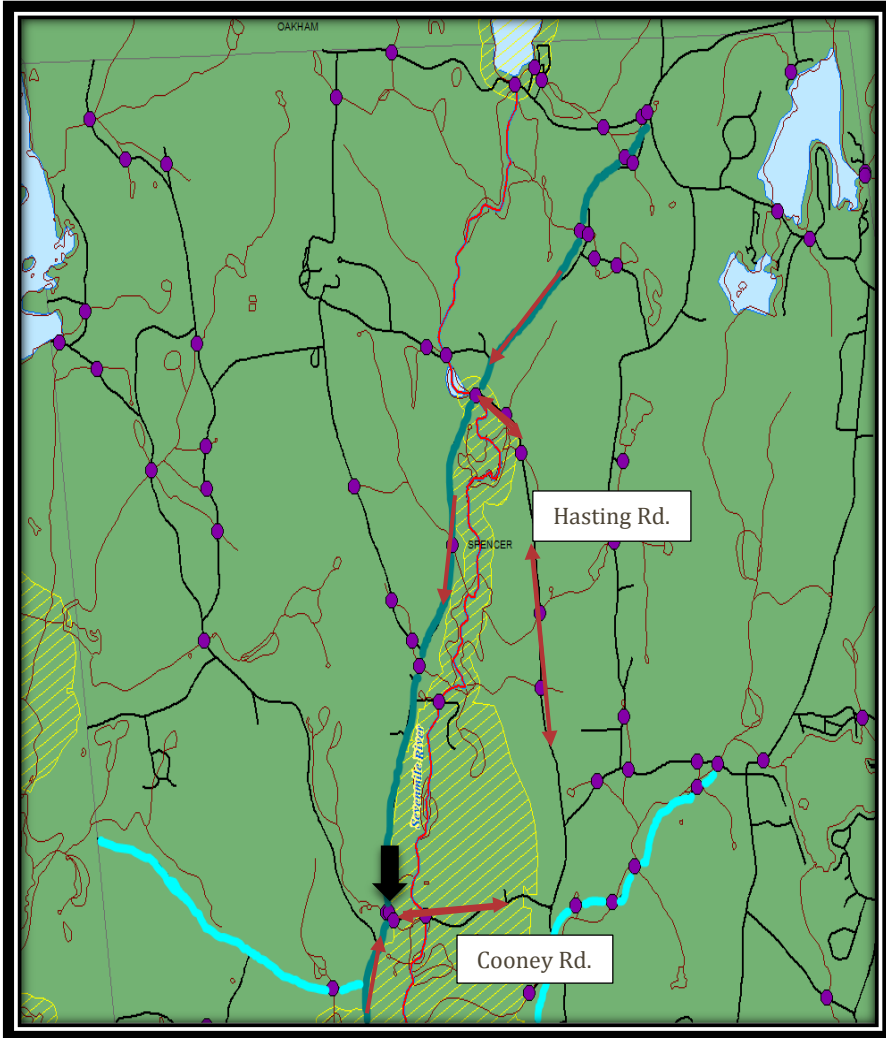

- ❖ This span of Rt. 31 would require a detour East down Cooney Rd. and North on Hasting Rd. or vice versa. The closest ADT taken by the MassDOT on Rt. 31 had 7863 cars recorded.
- ❖ The suggested detour circumnavigates a large portion of Spencer's priority habitats and several miles of the Seven Mile River.
- ❖ The reconstruction of this system may require attention to the second culvert in this system of two.

North Spencer Road 3



SPENCER



INLET

Characteristic	Field Observation
Date observed	11/22/2014
Type	Metal Pipe
Diameter	32"
Length	129'
Funding	Town
Stream Name (Tributary)	unknown (Seven Mile River)
Water Depth	5"
Outlet Drop	4" to stream bed

North Spencer Rd. (Rt.31): Culvert 4

Structural assessment results:
fair condition (0.67/1)

Aquatic assessment results:
significant barrier (0.50/1)

Major Problems:

- Scouring and Erosion
- Debris
- Low Flow

Improvement Considerations

Short Term:

- Address debris at inlet

Long Term:

- Routine assessments

Relative Fill Needed:

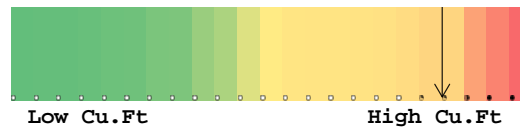

*ranked relatively against observed culverts



OUTLET

[FIELD NOTES]

- ❖ Sound like a physical barrier is present inside
- ❖ Mild constriction of stream
- ❖ Skewed alignment of stream

Impact

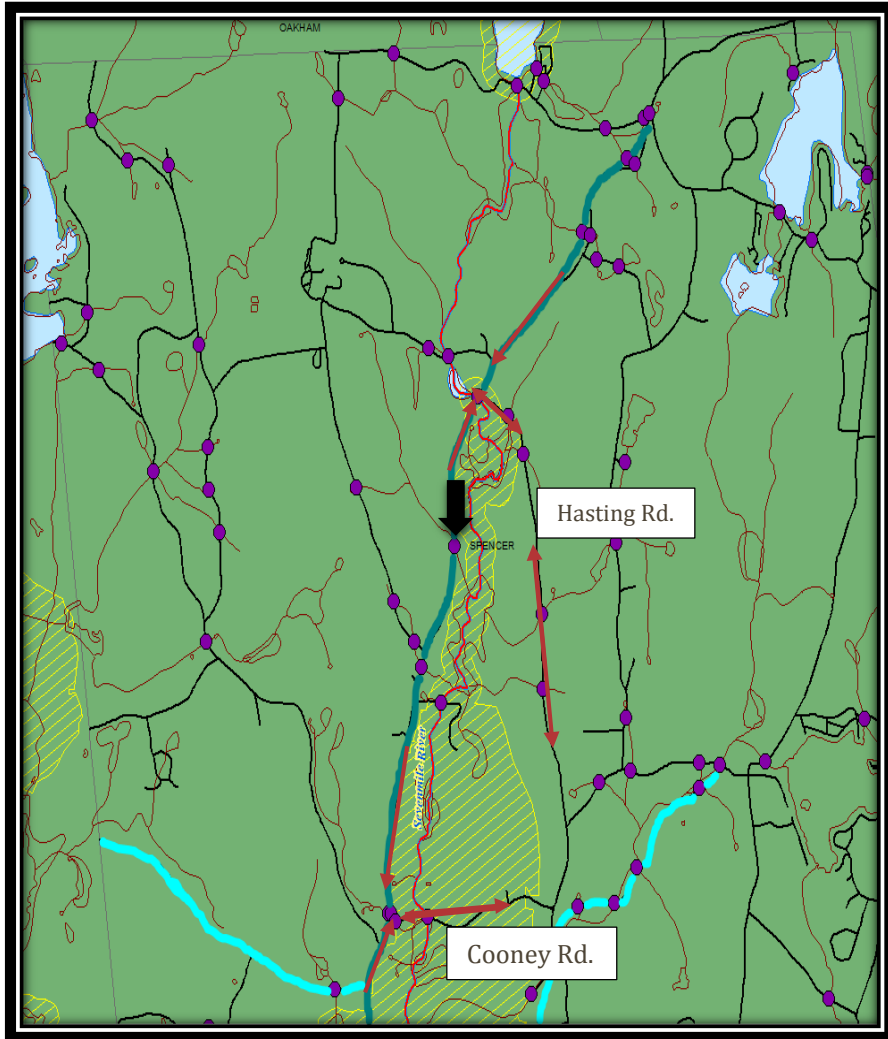

- ❖ This span of Rt. 31 would require a detour East down Cooney Rd. and North on Hasting Rd. or vice versa. The closest ADT taken by the MassDOT on Rt. 31 had 7863 cars recorded.
- ❖ The suggested detour circumnavigates a large portion of Spencer's priority habitats and several miles of the Seven Mile River.

North Spencer Road 4



Impact

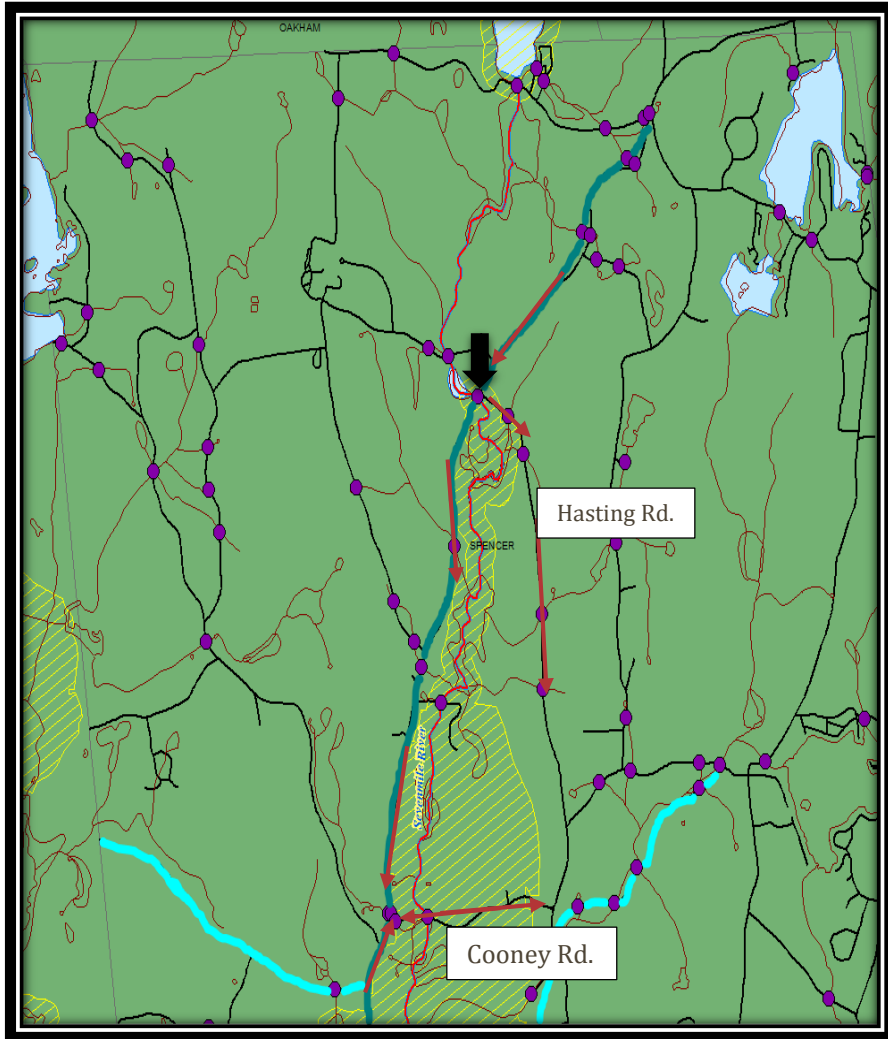

- ❖ This span of Rt. 31 would require a detour East down Cooney Rd. and North on Hasting Rd. or vice versa. The closest ADT taken by the MassDOT on Rt. 31 had 7863 cars recorded.
- ❖ The suggested detour circumnavigates a large portion of Spencer's priority habitats and several miles of the Seven Mile River.
- ❖ AASHTO rating of 67.7

North Spencer Road 5



SPENCER

*Inlet Unreachable



NOTE BROWN WATER AT OUTLET

Characteristic	Field Observation
Date observed	12/18/2014
Type	Metal/Concrete Pipe
Diameter	24"/30"
Length	120'
Funding	Town
Stream Name (Tributary)	unknown (Seven Mile River)
Water Depth	5"
Outlet Drop	48", Freefall

North Spencer Rd. (Rt.31): Culvert 6

Structural assessment results:
fair condition (0.67*/1)

Aquatic assessment results:
significant barrier (0.50/1)

Major Problems:

- * Embankment
- Scouring and Erosion
- Pipe in two pieces
- Road Condition

Improvement Considerations

Short Term:

- Check water quality
- Routine assessments

Long Term:

- Pipe replacement (match slope of stream and increase capacity)

Relative Fill Needed:

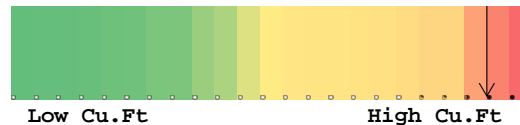

*ranked relatively against observed culverts



OUTLET

[FIELD NOTES]

- ❖ Dried out pipe to the right of outlet approx. 5 ft. high
- ❖ Water is brown and has distinct smell
- ❖ Concrete pipe on inlet side
- ❖ Metal pipe on outlet side
- ❖ Significant outlet drop
- ❖ Embankment experiencing some erosion

Impact

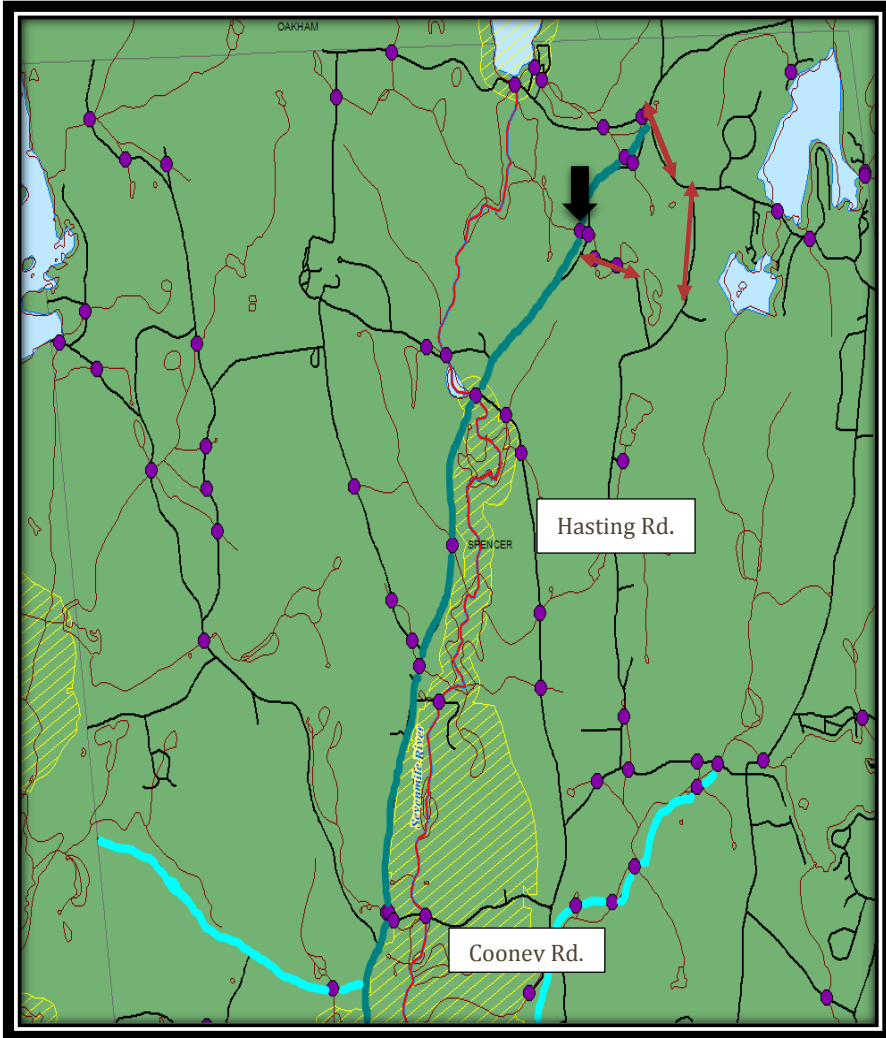

- ❖ This crossing system includes water leading to multiple priority habitats to the North.
- ❖ The detour during construction would lead to the East, down McCormick to Thompson Pond Rd. This adjustment would allow for steady flow of traffic but the road conditions may limit larger vehicles.
- ❖ High elevation levels between the road crossing and the stream bed could make failure a major concern. Lengthy reconstruction time would impact Spencer commuters heading towards Paxton and I-190.

North Spencer Road 6



SPENCER



INLET

Characteristic	Field Observation
Date observed	12/18/2014
Type	Concrete Pipe
Diameter	30"
Length	100'
Funding	Town
Stream Name (Tributary)	unknown (Seven Mile River)
Water Depth	1.5"
Outlet Drop	13", Freefall

North Spencer Rd. (Rt.31): Culvert 7

Structural assessment results:
fair condition (0.60*/1)

Aquatic assessment results:
significant barrier (0.50/1)

Major Problems:

- * Embankment
- Scouring and Erosion
- Pipe in two pieces
- Road Condition
- Clogging
- Low Flow

Improvement Considerations

Short Term:

- Clear debris
- Routine assessments

Long Term:

- Pipe replacement

Relative Fill Needed:

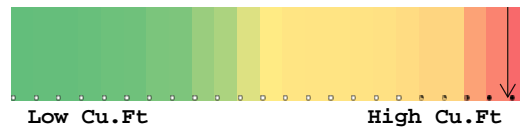

*ranked relatively against observed culverts



OUTLET

[FIELD NOTES]

- ❖ Pipe is broken at outlet
- ❖ Significant outlet drop
- ❖ Wetland area leading to inlet
- ❖ Runoff pipes leading to pool directly before inlet

Impact

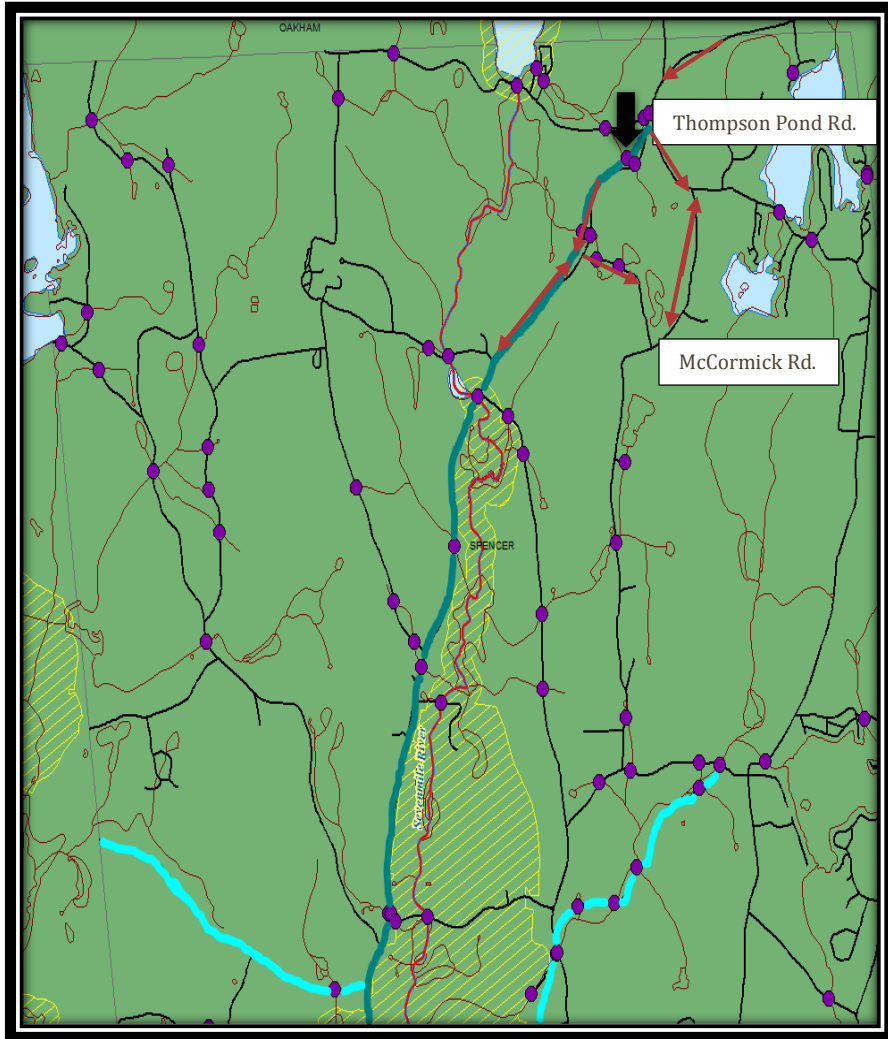

- ❖ This crossing system includes water leading to multiple priority habitats to the North.
- ❖ The detour during construction would lead to the East, down McCormick to Thompson Pond Rd. This adjustment would allow for steady flow of traffic but the road conditions may limit larger vehicles.
- ❖ High elevation levels between the road crossing and the stream bed could make failure a major concern. Lengthy reconstruction time would impact Spencer commuters heading towards Paxton and I-190.

North Spencer Road 7



SPENCER



INLET

Characteristic	Field Observation
Date observed	12/18/2014
Type	Metal Pipe
Diameter	30"
Length	48'
Funding	Town
Stream Name (Tributary)	unknown (Seven Mile River)
Water Depth	1"
Outlet Drop	2", Freefall

North Spencer Rd. (Rt.31): Culvert 8

Structural assessment results:
fair condition (0.73/1)

Aquatic assessment results:
moderate barrier (0.60/1)

Major Problems:

- Scouring and Erosion
- Clogging
- Ponding

Improvement Considerations

Short Term:

- Clear debris

Long Term:

- Adjust stream path through wetland area
- Pipe replacement

Relative Fill Needed:

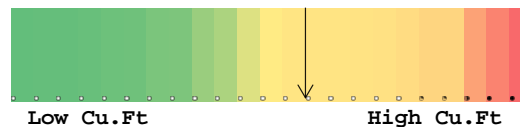

*ranked relatively against observed culverts



OUTLET

[FIELD NOTES]

- ❖ Side road off of Rt. 31, crossing runs underneath it
- ❖ Constricting culvert about 40 ft. upstream
- ❖ Wetland area with low flow and ponding
- ❖ Large scour pond at outlet

Impact

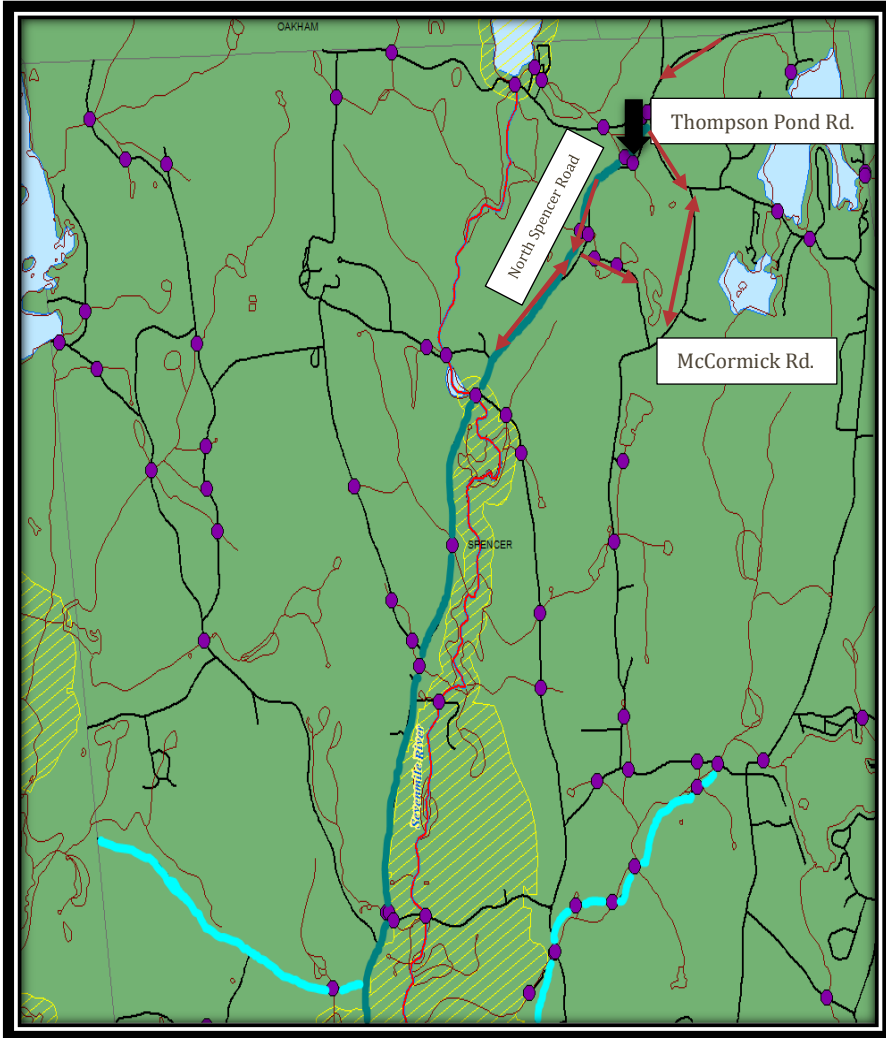

- ❖ This crossing system includes water leading to multiple priority habitats to the North.
- ❖ There would be no necessary detour for this crossing if the integrity of North Spencer Road culvert 7 crossing remains unaffected.
- ❖ The stream leads downhill from the direction of Thompson Pond about a half mile east. At the foot of North Spencer Road, the stream leads to wetlands full of wildlife. The high road elevation levels act as a barrier to this habitat.

North Spencer Road 8



5.0 Conclusion

In summary, this project involved the GPS mapping, River and Stream Continuity Project assessment, and an original structural field assessment of infrastructure crossings in Spencer, Massachusetts. The overall assessment led to recommendations for the Town of Spencer, in terms of long and short term maintenance needs. The team concluded that the integrated methods provided in this report could benefit and assist Spencer or any town encountering assessment complications with culverts, bridges, or dams.

5.1 Limitations

The team's initial design considerations were limited by field conditions in a significant way. Initial intentions to redesign specific crossings were inhibited by the level of access in the winter months determined by snow accumulation. Further examination was extremely difficult and confined to inspection data and the most recent photographic evidence. The design requirement had to be revised and conferred with the discretion of Steve Tyler. It was agreed that without further measurements and evaluations of the particular crossings chosen for redesign a full redesign would be unachievable. As a result of this constraint, the design of a new field structural assessment form was achieved.

5.2 Future Research: River and Stream Continuity Project

The designed structural assessment can be used in collaboration with the existing aquatic life assessment. The package includes various national and state standards and regulations found through extensive research on the subject. The team concluded the package could be used as a guideline for future advancements in the River and Stream Continuity

Database. According to Scott Jackson, it was the intention of the River and Stream Continuity Project to include a more comprehensive structural assessment for crossings.

One goal of the River and Stream Continuity Project was the ability to address municipalities during crossing reconstruction to minimize impediments on the ecological system. The package provided in this MQP can be used as an independent structural assessment in collaboration with their established system. Including an evaluation of this type may prove valuable in future consultations alongside the Aquatic Passage Score. The collaboration of assessments would also provide a further in-depth prioritization of crossings for their extensive inventory. Future research by the River and Stream Continuity Partnership could assist their goal of efficiently replacing failing culverts while being conscientious of the ecosystem involved. With technological advances in their inventory system this template for structural assessment could easily be used by a volunteer on a tablet or smartphone.

5.3 Town of Spencer: Environment and Community

The areas inspected in this report for Spencer, MA were chosen based on several factors. South Spencer Road, Meadow Road, and North Spencer Road are all being assessed by the Town for necessary maintenance and upgrades. The CMRPC has intentions of addressing issues along the Route 31 corridor (North Spencer Road and Meadow Road). Spencer has independent plans to improve the condition of certain sections of South Spencer Road. Finally, West Main Street functions as an important transition in the Northbound and Southbound flow of these roads. The widening of roads, replacement of culverts, maintenance of bridges, and possible realigning of these roads are all being considered as potential improvements, each addressing different sections of the roads.

In order for Spencer and the CMRPC to complete the most significant improvements, they will need to provide thorough proof of their project's necessity. Without extensive assessments, proper State and Federal funding will most likely not be achieved. The cooperation with the River and Stream Continuity Project may be one aspect that can improve a case for funding. With sufficient funding, all parties involved can ensure the upcoming infrastructure projects will be conscientious of all constraints during the design and maintenance processes of the crossings.

Spencer now has the capability to reference the crossing profiles and structural assessments as an expansive illustration in future projects involving the infrastructure reviewed. Possible complications with each of the twenty-two crossings have been predicted, estimated, and analyzed to the degree discussed in the methods. This model of analysis should continue for all crossings in Spencer on a biannual schedule in order to correlate with NBIS. Ultimately, inspection to this degree will advance the integrity of Spencer's river and stream ecosystems and ensure the safety of the residents and pedestrians using the Town's roads in the future.

Bibliography

- 3, Chapter. CULVERTS (n.d.): n. pag. Web. 10 Oct. 2014.
http://water.epa.gov/polwaste/nps/urban/upload/2003_07_24_NPS_unpavedroads_ch3.pdf
- Action Steps for Improved Infrastructure in Massachusetts*. Rep. Boston: BSCES, 2013. Print.
- "Asset Management." *Background*. N.p., n.d. Web. 03 Nov. 2014.
http://www.fhwa.dot.gov/infrastructure/asstmgmt/tamcs_cms02.cfm
- Cabbage, Michael, and Leslie McCarthy. "NASA Science Leads New York City Climate Change 2015 Report." *Climate Change: Vital Signs of the Planet*. NASA, 18 Feb. 2015. Web. 26 Feb. 2015
- "Code of Ethics." Code of Ethics. N.p., n.d. Web. 13 Oct. 2014.
<http://www.asce.org/Ethics/Code-of-Ethics>
- CMRPC. "Route 31 Corridor Study Draft". Central Massachusetts Regional Planning Commission. 12 Feb. 2015. *awaiting publication
- "Culverts — Proper Use and Installation." *Wisconsin Transportation Bulletin No. 15 (2004)*: n. pag. Web. 10 Feb. 2015.
- Culvert Repair Practices Manual*. McLean, VA: U.S. Dept. of Transportation, Federal Highway Administration, Research and Development, Turner-Fairbank Highway Research Center, 1995. Web.
- "Culverts Types, Design, Installation and Materials." Culvert. N.p., n.d. Web. 14 Oct. 2014.
<http://www.aboutcivil.org/culvert-definition-types-culvert-materials.html>
- Delaney, Eileen P., ed. "Assessment and Rehabilitation of Existing Culverts." *National Cooperative Highway Research Program*. N.p., 2002. Web. 14 Oct. 2014.
<onlinepubs.trb.org/onlinepubs/nchrp/nchrp_syn_303.pdf>
- Hunt, John H., Stephen M. Zerges, Brian C. Roberts, and Bart Bergendahl. "Culvert Assessment and Decision-Making Procedures Manual For Federal Lands Highway." (n.d.): n. pag. Federal Highway Administration, Sept. 2010. Web. 1 Feb. 2015.
- "Hydraulic Design of Energy Dissipators for Culverts and Channels." (n.d.): n. pag. Federal Highway Administration. Web.
- "Low Volume Roads BMPs." *BLM - The Bureau of Land Management*. N.p., n.d. Web. 10 Mar. 2015.
- "MassGIS Datalayers." *MassGIS*. N.p., n.d. Web. 15 Feb. 2015.
<<http://www.mass.gov/anf/research-and-tech/it-serv-and-support/application-serv/office-of-geographic-information-massgis/datalayers/layerlist.html>>

- "River and Stream Continuity Project." River and Stream Continuity. N.p., n.d. Web. 14 Oct. 2014. <http://www.streamcontinuity.org/index.htm>
- "Transportation." *Transportation | Central Massachusetts Regional Planning Commission (CMRPC)*. CMRPC, n.d. Web. 03 Nov. 2014.
- Trevis, Robert E., P.E. "Culvert Inspection & Inventory Field Handbook." (n.d.): n. pag. Oregon Department of Transportation, 13 Mar. 2013. Web. 1 Feb. 2015.
- "Tropical Storm Irene By the Numbers." *Climate Change Team*. Vermont Agency of Natural Resources, 3 Oct. 2011. Web. 01 Feb. 2015.
- Tuan, Le Anh. *Open Channel Hydraulics for Engineers: A Textbook for Students on the Fields of Hydraulic Works, Construction, and Environmental Engineering*. Saarbrücken: LAP Lambert Academic, 2011. Print.
- Wargo, R. S. and Weisman, R. N. (2006), A COMPARISON OF SINGLE-CELL AND MULTICELL CULVERTS FOR STREAM CROSSINGS. *JAWRA Journal of the American Water Resources Association*, 42: 989–995. doi: 10.1111/j.1752-1688.2006.tb04509.x
- "Who We Are." *Central MA Regional Stormwater Coalition - Who We Are*. CMRSWC, n.d. Web. 04 Mar. 2015.
- Wilson, Pete. "Culvert Inspection, Condition Ratings & Inventory Coding." (n.d.): n. pag. Minnesota Department of Transportation. Web. 1 Feb. 2015

Appendix A – Project Proposal

SPENCER INFRASTRUCTURE ANALYSIS

A Proposal for a Major Qualifying Project Report:

Submitted to Faculty of

WORCESTER POLYTECHNIC INSTITUTE

In partial fulfillment of the requirements for the

Degree of Bachelor of Science

By

Ryan Bagge

Kevin Galvin

Seamus Gallagher

Date: November 4, 2014

Approved:

Professor Suzanne LePage, Advisor

Capstone Design

To meet the requirements put forth by the Accreditation Board for Engineering and Technology (ABET) this Major Qualifying Project will culminate in a design portion that incorporates engineering standards and realistic constraints. “These constraints will include most of the following considerations: economic; environmental; sustainability; constructability; ethical; health and safety; social; and political”. This section will provide a brief description on how each of these considerations will be addressed during this project.

Economic

This project will culminate in a redesign of high priority culverts. In order to categorize which culverts rank the highest, an economic consideration will be included. Cost estimates will be made for the materials chosen for the culvert as well as construction costs, and any other general requirements. These estimates will be presented to the Town of Spencer for review.

Environmental

An emerging factor in culvert and stream crossing design is how it affects the environment surrounding it. Stream Continuity Groups have started a push for culvert design that considers how the crossing could affect aquatic life, the hydrology of the stream, and the erosion surrounding it. These factors will be considered during the project and impact the culvert design process.

Sustainability

Sustainability clearly plays a huge part in the design of any type of infrastructure. Designs need to be able to hold through storms, handle high water flow periods, and maintain a

good driving surface for vehicles. Proper diligence when analyzing the ecological conditions will also improve the chance of sustaining the populations of the aquatic life that interact with the crossings.

Constructability

When redesigning high priority culverts the team will need to address factors revolving around the constructability of the recommendation. This project will need to account for traffic patterns, the amount of storage on the side of the road for materials, and how the surrounding community will be affected by job.

Ethical

The American Society of Civil Engineers (ASCE) Code of Ethics will be abided by during the completion of this Major Qualifying Project. The Code states that “engineers shall hold paramount the safety, health and welfare of the public; perform services only in areas of their competence; act in such a manner as to uphold and enhance the honor, integrity, and dignity of the engineering profession and shall act with zero-tolerance for bribery, fraud, and corruption” (Code of Ethics, 2). This Code will be followed throughout this project with the intention of providing the Town of Spencer with the best recommendations that will promote public safety and enhance the infrastructure in Spencer.

Health and Safety

The redesign of proposed culverts will be structurally sound for all dead load and live loads that may occur once they are constructed. This will ensure the safety of all pedestrians

and motorists that pass the crossing. All standards and guidelines will be followed explicitly and calculations will be thorough.

Social and Political

During this project, the team will work alongside the Town of Spencer in developing recommendations for culvert redesign. Socially this will affect the citizens of the Town if any recommendations are deemed ready for construction. A political aspect will be involved when addressing where the funding for a construction project will come from. The Town's government will need to be involved when budgeting the project.

Table of Contents

Capstone Design	i
Economic.....	i
Environmental.....	i
Sustainability.....	i
Constructability.....	ii
Ethical.....	ii
Health and Safety.....	ii
Social and Political	iii
Table of Figures.....	2
1. Introduction	3
2. Background	6
Type of Culverts	6
Inventory Procedures.....	9
River and Stream Continuity Project.....	11
Environmental Significance.....	11
3. Methodology.....	13
Geographic Scope of Work	13
Schedule.....	14
GPS Mapping.....	15
Inventory of Culverts.....	15
Prioritizing Problem Culverts	16
Culvert Design	16
Project Deliverables	16
Bibliography	18

Table of Figures

Figure 1 - Scope of Work in Spencer (Souce: Google Maps, 2014).....	4
Figure 2 - Corrugated Metal Pipe Culvert (Photo: Ryan Bagge, 2014).....	7
Figure 3 - Concrete Pipe Culvert (Photo: Ryan Bagge, 2014).....	7
Figure 4 - Double Arch Culvert (Photo: Ryan Bagge, 2014)	8
Figure 5 - Stone Masonry Embedded Culvert (Photo: Ryan Bagge, 2014)	8
Figure 6 - Proposed Schedule for Project	14

1. Introduction

The Town of Spencer, Massachusetts is a rural town with a population of over 11,500. The Town covers roughly 34 square miles of land, 1.2 of those miles are bodies of water. The methods of this project will assess the way a portion of Spencer's infrastructure interacts with the streams, brooks, rivers, and reservoirs with the use of culverts and bridges. Stream and habitat continuity is a conscientious effort gaining recognition by municipalities in regards to infrastructure construction. The status of infrastructure in the areas to be assessed is vital to the Town both environmentally and socially. Our final report intends to give the necessary attention to all the impacts the bridges and culverts may have using several established methods of analysis together for a sound conclusion.

Currently there is no coherent inventory able to prioritize the redesign of outdated infrastructure in Spencer. Massachusetts and particularly Central MA is in the process of several audits on the status of infrastructure. A joint initiative led by Scott Jackson of UMass Department of Environmental Conservation focused on an inventory to account for the level of environmental impact created by the road-crossings in Massachusetts. This inventory takes into account constraints not currently regulated by the state. Current inventory in Spencer was conducted with NBIS standard analysis and recent analysis has been conducted by the CMRPC (Central Massachusetts Regional Planning Commission). Those inventories take into account several significances such as structural integrity, level of maintenance, volume of traffic, size and shape. Future State and Federal funding will be in best use when all possible constraints are considered.

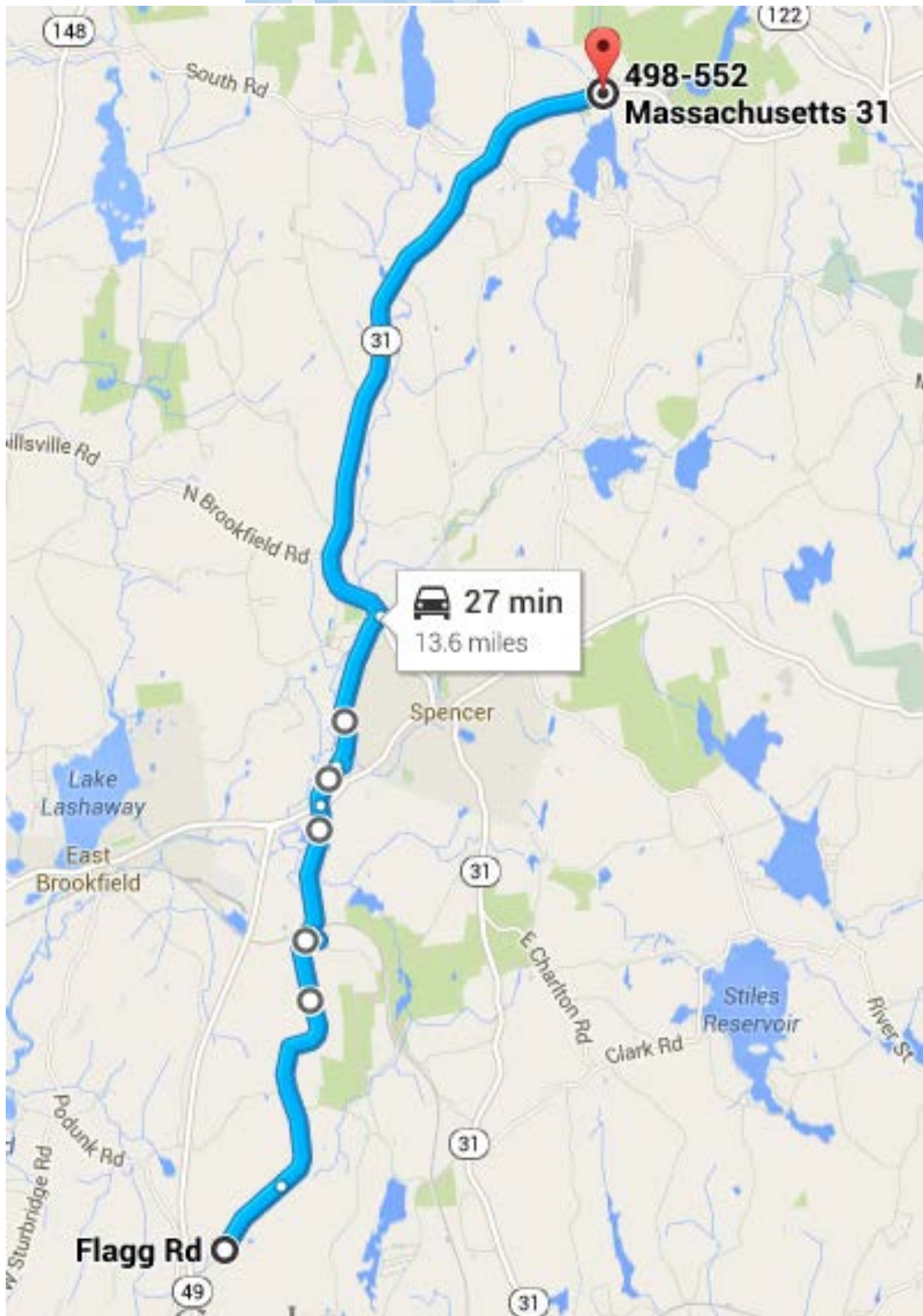

Figure 1 - Scope of Work in Spencer (Source: Google Maps, 2014)

This project will primarily follow South Spencer Rd. and the Route 31 buffer zone, which includes crossings on Meadow Rd. and over Muzzy Brook. Meadow Road, North and South Spencer Road junction to span the entire length of the Town from its Northeast to Southwest borders. Much of the land parallel to this area is marshland. Developed within the Route 31 corridor are multiple wells supplying the Town with their drinking water. Perpendicular to that area is Muzzy Brook, which runs parallel with Main Street in the most urbanized section of Spencer. These areas play a significant role in the wellbeing of Spencer's citizens. Assessment of all crossings in the area should lead to necessary maintenance and future design upgrades prioritized in a coherent arrangement for the Town.

2. Background

Type of Culverts

The scope of this project will include assessing several different types of culverts with ranging sizes and materials. A culvert is defined as “an opening through an embankment for the conveyance of water by mean of pipe or an enclosed channel” (Culvert Types, 3). It is also important to note that any crossing longer than 20 feet wide is characterized as a bridge. This limit makes distinguishing between a culvert and a bridge straightforward.

One type of culvert the team will be assessing is a single pipe culvert. This type can be made from corrugated metal as well as concrete. Pipe culverts tend to be the cheapest option but can lead to issues including hydraulic jumps and erosion of embankments during high flow periods. A hydraulic jump is defined as “the rise in water level, which occurs during the transformation of the unstable “rapid” or supercritical flow to the stable “tranquil” or subcritical flow” (Tuan, 76). These types of jumps create unnatural environments for wildlife and can endanger their habitats. Examples of a corrugated metal and concrete pipe in Spencer can be seen below in Figures 2 and 3.



Figure 2 - Corrugated Metal Pipe Culvert (Photo: Ryan Bagge, 2014)



Figure 3 - Concrete Pipe Culvert (Photo: Ryan Bagge, 2014)

Another type of culvert we will be adding to the inventory is single and multiple arch culverts. These culverts can also be made out of corrugated metal or precast concrete. When examining older culverts, stone masonry passages can even be found. Pictures of a double arch concrete culvert and a stone masonry embedded culvert are shown below in Figures 4 and 5.



Figure 4 - Double Arch Culvert (Photo: Ryan Bagge, 2014)



Figure 5 - Stone Masonry Embedded Culvert (Photo: Ryan Bagge, 2014)

With many stream crossings, comes the task of inspecting and maintaining them to ensure safety for people of the Town. Different agencies have used different procedures when performing an inventory but essentially the same characteristics are documented. This section will discuss the inventory methods of transportation agencies as well as the Town of Spencer and where the field is now trending.

Inventory Procedures

Transportation agencies of all municipality levels have to deal with the maintenance and rehabilitation of pipes and culverts. Whether it is on the local, state, or federal level, agencies should have plans in place to handle culvert inspection and ensure the safety of the public. Realizing that there is no universal method to running these programs, the National Cooperative Highway Research Program conducted a research project in 2002 titled the “Assessment and Rehabilitation of Existing Culverts”. The result was a study that presents “what management systems and methods are being used by transportation agencies to predict the service life of pipes” (Delaney, 7). The study found that State DOT’s had pipe assessment programs that ranged from none to a system that included a central database. MaineDOT initiated one of the more advanced programs. The agency created a database that would become their main data source for a transportation management system and allow maintenance personnel to be more “proactive, rather than reactive, in their pipe management program” (Delaney, 8). A common need among transportation agencies is the need for a system that promotes repair before accidents occur.

The Federal Highway Administration (FHWA) designed a Culvert Management System (CMS) in the early 2000’s under the Local Technical Assistance Program. Many agencies already performed some of the functions provided by the CMS. However, the new program gathered all the functions already in use and formalized and automated them (Asset Management, 1). Once the key features were determined, FHWA created five modules that could be used by agencies as part of a software program. The modules were: inventory, condition, maintenance and repair, work funding, schedule (Asset Management, 2). The CMS provided municipalities with a

means of tracking conditions of their culverts, determining when maintenance was needed, and assistance in funding and scheduling repair work. However, the NCHRP study found through a questioner, that not many of the agencies used this program in their work (Delaney, 10). Although it may not have been widely used, the concepts used in the CMS program are used by every agency in one way or another.

The Town of Spencer alongside MassDOT has performed a culvert inventory using National Bridge Inspection Standards (NBIS). Their inventory criterion consists of a rating system for the deck, superstructure, substructure, an AASHTO rating, and other general information about the bridge or culvert. These ratings allow for a quick ranking of which crossings need the most work and which are suitable for the time being. The Town also uses a GPS device to map bridges outfalls and upload them to their GIS database run by the Central Massachusetts Regional Stormwater Coalition. This database contains all roadways in the Town as well as point locations of outfalls, catch basins, and any other infrastructure of interest.

The CMRCP has also performed an inventory of the crossings in Spencer on Rt. 31. This Commission works to assist local municipalities in developing present and future plans for transportation maintenance while accounting for safety and environmental impacts (Transportation, 1). Their inventory includes a GIS mapping of the crossings and an excel sheet containing the following information: pipe size and length, type of material, condition of the pipe, and a field observations section. While the field observations section allows for helpful notes to be taken, a more structured form would ensure that a repeated process takes place.

River and Stream Continuity Project

This project will introduce a new inventory system to the Town of Spencer. The scope of the project will be included in the Stream Continuity Database. UMass Amherst started the database in 2000 in cooperation with several other agencies and organizations. The inventory contains stream crossings in over five states in the Northeast. The information includes requirements for wildlife passages, culvert designs, evaluating barriers to wildlife passages, and field protocol. GPS coordinates have been located for nearly eight thousand crossings.

It has been a growing practice to pay special attention to wetlands and water bodies used as a working habitat since 1970 with the Clean Water Act and the Environmental Protection Act. The stream continuity database embodies this involvement and displays data regarding the level of impediment on the crossing's original natural state. This initiative is now a major concentration for UMass Professor of Environmental Conservation, Scott Jackson. Jackson has helped to create a database representing the Massachusetts Stream Crossing Handbook and collected by trained delegates. The work in Spencer will be the beginning of this process in the town. Each crossing is given a crossing code, aquatic score, and a terrestrial passage score. The inventory creates approaches towards prioritizing the replacement of road-stream crossings. Reviewing and comparing stream and river crossings on a large scale with this efficiency can greatly impact the effects of infrastructure on wildlife and river health.

Environmental Significance

Multiple characteristics of the region to be reviewed make the water bodies essential to the ecological well-being in Spencer. Spencer has several reservoirs within its immediate watershed. Also being reviewed are the stream crossings on Meadow Road, where one of the

Town's major well sources of drinking water is located. The Town Center is located not far from the source of water along Route 9, which is maintained by the state. After initial field visits, it is apparent that the buffer of infrastructure on Route 9 could be a major constraint on wildlife passage and river health, depending on structural integrity of crossings, and the amount of pollution. Route 31 and South Spencer Road have a similar relationship with the watershed system they pass through. A significant amount of wildlife resides in the area including over 20 potential vernal pools serving as active habitats. The environmental impact can vary from dry streams collecting stormwater with outdated culverts to serious scour pools in riverbeds blocking fish passage. Through the inventory collected in the area, the crossings with the most significant need for maintenance and reconstruction will be determined.

3. Methodology

The goal of this project is to assist the Town of Spencer in creating a database of the town's culverts and prioritize them to determine which culverts are the most critical to be redesigned. The team will accomplish this goal through the following objectives:

- GPS Mapping of the location of culverts on South Spencer Road and the Route 31 buffer zone
- Taking inventory of the culverts with a hybrid method created by combining Scott Jackson's inventory method with the current method that the Town of Spencer uses
- Prioritizing problem culverts by developing evaluation criteria for all culverts within the scope of the project with the help of the Town of Spencer
- Performing a Redesign of the culvert that is in the most critical condition

Geographic Scope of Work

This project will be conducted in the Town of Spencer and will primarily follow South Spencer Road and the Route 31 buffer zone, including crossings along Meadow Road and Muzzy Brook, the North and South Spencer Road junction. The area that the project focuses on spans the entire length of the Town of Spencer from its Northeast to Southwest borders providing a good sample of culverts that are found within the town.

Schedule

Term	B-Term								Winter Break	C-Term							
	28-Oct	3-Nov	10-Nov	17-Nov	24-Nov	1-Dec	8-Dec	15-Dec		15-Jan	20-Jan	26-Jan	2-Feb	9-Feb	16-Feb	23-Feb	2-Mar
Week Starting																	
Finish GPS Mapping																	
Attend Scott Jackson training session																	
Create hybrid Inventory data sheet																	
Complete Inventory																	
Prioritize Inventory																	
Select Candidates for Redesign																	
Begin Redesign																	
Complete Final Rough Draft																	
Hand in Final Paper																	
Background & Introduction																	
Methodology																	
Results																	
Conclusion																	
Abstract & Executive Summary																	
Editing Report																	
Presentation																	

Figure 6 - Proposed Schedule for Project

The image above contains the proposed schedule that the team plans to use to complete the project. The GPS Mapping will be performed with a Leica GPS device to map the locations of the culverts within the geographic scope of work for the project. In order to use Scott Jackson’s inventory method, the team must attend a training session with him to be qualified to enter data into his database of culverts. The team will combine some aspects of the Town of Spencer’s inventory data sheet with Scott Jackson’s inventory data sheet to create a hybrid inventory data sheet. The team will consult with the Town of Spencer to develop evaluation criteria in order to prioritize the inventory the team will take. To select the candidate for redesign, the team will review the prioritized list of culverts to determine which has the greatest need to be redesigned. Then the team will perform a redesign for the culvert that has been selected as the most critical. The final step of the project will be writing the report, which will largely take place during C Term (Figure 6). Upon completion of the written report, the team will present our findings to the project liaison Steve Tyler.

GPS Mapping

The project team will use a Leica GPS device to map the location of culverts in Spencer on South Spencer Road and the Route 31 buffer zone, including Meadow Road, Muzzy Brook, and North Spencer Road. The culverts will be located by using paint markings on the street that signify water is crossing under the road in addition to a map provided by the project liaison, Steve Tyler, showing the general location of culverts in the specified project area. The locations of these culverts will be mapped and uploaded to the Spencer CMRSWC website for the team to review and use as a reference for future work.

The Leica device that the team will use has a data sheet that includes information such as the structural details of the culvert including pipe diameter, pipe condition, and pipe material in addition to GPS coordinates. From this additional information, the group will categorize the culverts based on the material and size of the culvert in an effort to better analyze the different types of culverts that the Town of Spencer has.

Inventory of Culverts

The project team will take inventory of all the culverts that have been mapped by creating a hybrid of the current method that the Town of Spencer uses to take inventory of culverts and the method that Scott Jackson employs. This hybrid inventory will be created after completing a training session with Scott Jackson to ensure that the project team follows all the protocols required for his road-stream crossing assessment database. The team will be using a hybrid inventory data sheet to assist the Town of Spencer in updating their current method of inventory with some of the protocols that Scott Jackson requires for his river-stream crossing

assessment inventory method because Scott Jackson's method is becoming a more accepted method for the inventory of culverts.

Prioritizing Problem Culverts

The team will prioritize the list of culverts that are inventoried to identify those that are the most critical to redesign. Some factors that may influence the prioritizing of the culverts could be the condition of the pipe, the area where the culvert is located, the body of water that is crossing underneath the road, and the condition of the road above the culvert. The team will consult with Steve Tyler to develop the evaluation criteria for the culverts in the inventory allowing the team to rank the problem culverts based on the needs of the Town of Spencer.

Culvert Design

The project team will propose a redesign of the culvert in the most critical condition based on our prioritization of the problem culverts within the Town of Spencer. If time permits, the team will propose additional redesigns of other critical culverts within the focus area of the project. The redesigned culvert will meet all specifications and regulations enforced by the State and the involved transportation agencies.

Project Deliverables

At the conclusion of the project, the team will present our report and turn in the project deliverables to the project liaison Steve Tyler. The final deliverables for the project will include the GPS Mapping data that will be uploaded to the Spencer CMRSWC website. Another project deliverable will be the inventory data sheets for each of the culverts under investigation. The team will also provide the prioritized list of culverts that helped to determine which culvert was

the most critical to be redesigned. The final deliverable will be the team's suggested redesign of the culvert that was determined to be the most critical.

Bibliography

- 3, Chapter. CULVERTS (n.d.): n. pag. Web. 10 Oct. 2014.
http://water.epa.gov/polwaste/nps/urban/upload/2003_07_24_NPS_unpavedroads_ch3.pdf
- "Asset Management." *Background*. N.p., n.d. Web. 03 Nov. 2014.
http://www.fhwa.dot.gov/infrastructure/asstmgt/tamcs_cms02.cfm
- "Code of Ethics." Code of Ethics. N.p., n.d. Web. 13 Oct. 2014. <http://www.asce.org/Ethics/Code-of-Ethics>
- "Culverts Types, Design, Installation and Materials." Culvert. N.p., n.d. Web. 14 Oct. 2014.
<http://www.aboutcivil.org/culvert-definition-types-culvert-materials.html>
- Delaney, Eileen P., ed. "Assessment and Rehabilitation of Existing Culverts." *National Cooperative Highway Research Program..* N.p., 2002. Web.
<onlinepubs.trb.org/onlinepubs/nchrp/nchrp_syn_303.pdf>
- "River and Stream Continuity Partnership." River and Stream Continuity. N.p., n.d. Web. 14 Oct. 2014.
http://www.streamcontinuity.org/introduction/continuity_partners.htm
- "Transportation." *Transportation | Central Massachusetts Regional Planning Commission (CMRPC)*. CMRPC, n.d. Web. 03 Nov. 2014.
- Tuan, Le Anh. *Open Channel Hydraulics for Engineers: A Textbook for Students on the Fields of Hydraulic Works, Construction, and Environmental Engineering*. Saarbrücken: LAP Lambert Academic, 2011. Print.

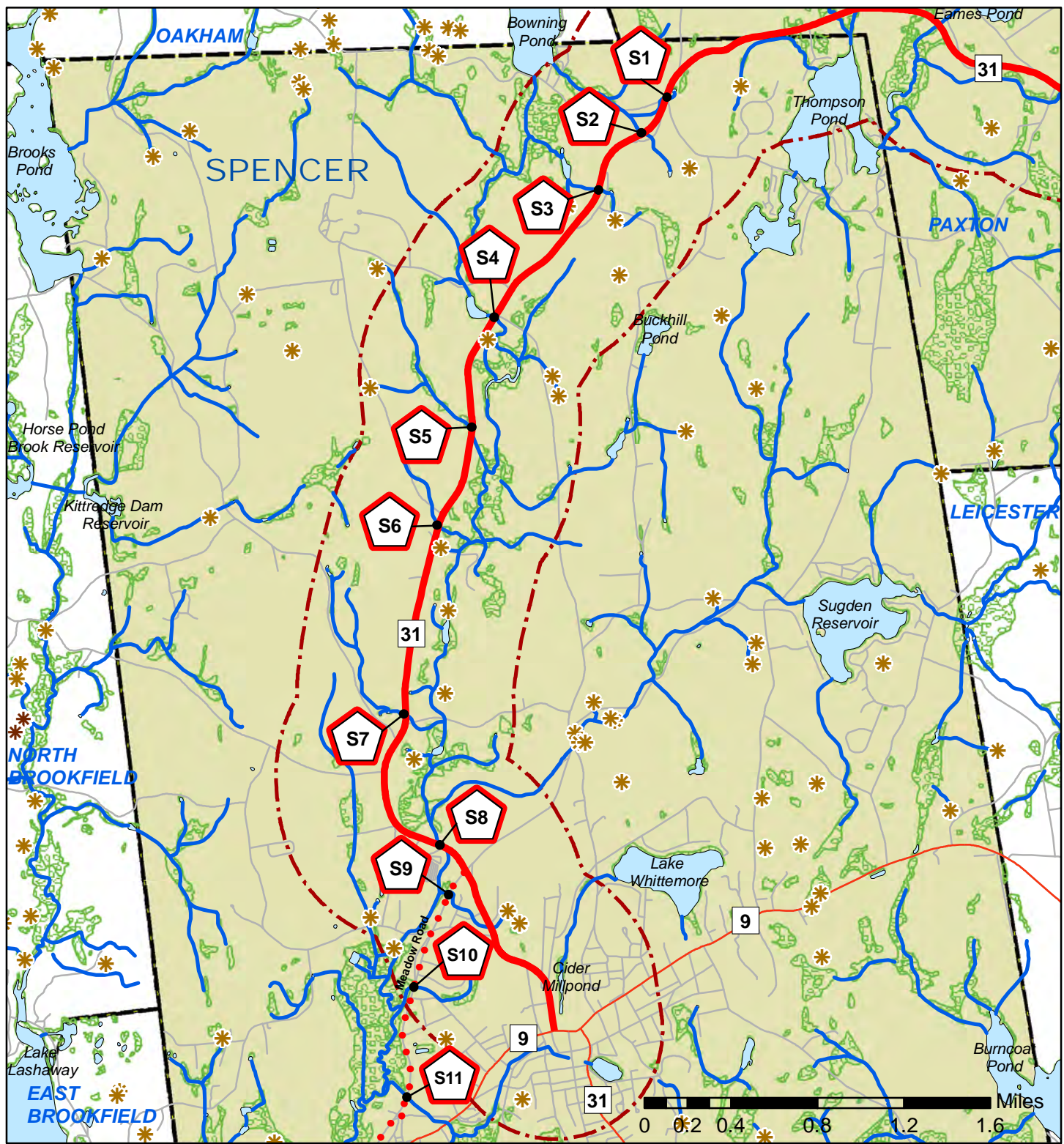

ROUTE 31 CORRIDOR PROFILE: SPENCER

Major Drainage Structures

Figure 47



Legend

- Route 31 - Holden, Paxton, Spencer
- Route 31 1-Mi Buffer Zone
- Streams Intersecting Rt 31
- Rivers & Streams
- NHESP Certified Vernal Pools
- Potential Vernal Pools
- Drainage structure or bridge
- DEP Wetlands (Jan. 2009)
- Waterbodies Intersecting Rt 31
- Waterbodies
- Towns

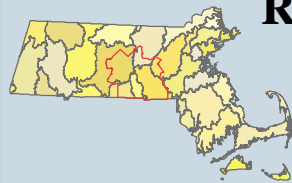

Major Watersheds

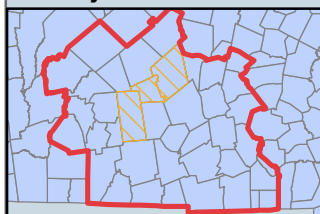

River and Stream Continuity Project

**Instruction Guide for the 3/15/13 Field Data Form:
Road–Stream Crossing Inventory**

Developed by the

River and Stream Continuity Partnership

Including:

University of Massachusetts Amherst

The Nature Conservancy

Massachusetts Division of Ecological Restoration-Riverways Program

American Rivers

CONTACTS

Scott Jackson

Department of Environmental Conservation
Holdsworth Hall
University of Massachusetts
Amherst, MA 01003
(413) 545-4743; sjackson@umext.umass.edu

Alison Bowden

The Nature Conservancy
99 Bedford St., 5th Floor
Boston, Massachusetts, 02111
(617) 532-8300; abowden@TNC.ORG

Carrie Banks

Division of Ecological Restoration – Riverways Program
MA Department of Fish and Game
577 Western Ave.
Wilson Hall, Room 209
Westfield, MA 01086
(413) 579-3015; Carrie.Banks@state.ma.u

Amy Singler

American Rivers
25 Main Street, Suite 220
Northampton, MA 01060
413-584-2183; asingler@americanrivers.org

For more information go to: **www.streamcontinuity.org**.

OVERVIEW

The River and Stream Continuity Project is a program that trains volunteers and technicians to inventory river and stream road crossings (culverts, bridges, etc.). This information will be used to help determine if crossings are barriers to fish and wildlife movement, and cause habitat fragmentation. Barriers that are identified can then be prioritized for remediation.

These instructions provide additional explanations for the questions on the Road–Stream Crossing Inventory Field Data Form. Remember that the data form is for the entire river or stream crossing, which might include multiple culverts or multiple cell bridges. With the exception of dimensions, answer each question for the crossing as a whole. It is not necessary that every cell of a multiple cell bridge crossing span the channel. Look instead to determine whether, for example, the combination of cells collectively spans the stream channel.

It can be difficult to determine how best to evaluate multiple culvert/cell crossings. Please use the following as a guide for these inherently confusing situations.

1. When the multiple culverts/cells are similar in material, size and elevation use the best case for answering questions on page one of the crossing form. For example if a crossing has two similar sized culverts and where only one of the culverts contains substrate that is comparable to that found in the natural stream channel and the other does not, then answer “comparable” to question #12 (Crossing substrate).
2. When the culverts/cells are significantly different in either material, size, elevation or other characteristics then focus the review on the structure that carries most of the stream flow.
3. When the culverts/cells are significantly different but no single structure carries the majority of the stream flow then focus the review on the “best case” structure considering the full range of characteristics on the data form. If it is not clear which structure is the “best case” structure then consult with the survey coordinator.

Please be sure to answer every question.

SHADED BOXES

The Survey Coordinator will provide the necessary information for these boxes. These include “Coordinator,” “Crossing ID#,” “Stream/River,” “Road,” “Town” and “Flow condition” as well as information related to entering and reviewing data in the Crossings Database. *Do not enter data in these boxes.*

Survey teams in the field they may encounter unmapped crossings or be unclear as to whether or not the crossing they are assessing is one of the crossings depicted on the map. A crossing may exist on the map that does not exist in the field (in this case the “No crossing” option should be checked on line 3 of the field data form). Survey teams also may encounter unmapped crossings because either the road or the stream was unmapped or due to errors in the GIS analysis that generated the crossings. In some cases the crossing on the map may just be a little off.

When an unmapped crossing is encountered in the field survey teams should write “Unmapped crossing #__” (providing a unique number for each unmapped crossing) at the top of the field data form. Later the Survey Coordinator will forward the record to the National Coordinators for assignment of a crossing code.

BASIC INFORMATION

GPS Coordinates (lat/long) – Use of a GPS (Global Positioning System) unit is required.

- Map Datum: It is best to use datum WGS84 but NAD 83 (North American Datum 1983) or NAD 83 Conus are acceptable as well.
- Location Format: Use projection Latitude-Longitude decimal-degrees (hddd.ddddd or dd.ddd) with 6 decimals if possible.
- If coordinates are collected in decimal degrees then check the “Decimal degrees” check box and enter coordinates in the spaces provided.
- If coordinates are collected in degrees, minutes and seconds then check the “Degrees, minutes, seconds” check box and enter coordinates in the spaces provided.
- Make sure that you are standing on the road above the culvert when taking the GPS point.

Date – Date that the crossing was evaluated.

Location – Provide enough information about the exact location of the crossing so that another person using your data sheet will be confident that they are at the same crossing that you evaluated. For example “between telephone poles # 162 and 163” or “right across from the Depot Restaurant.”

Observer – Your name.

Photo IDs – If you took digital photos record the ID numbers from your camera. Enter “none” if you did not take photos.

Digital photographs are an extremely useful tool to use in assessing potential barriers to aquatic organism passage. When taking photos, be sure to use the date/time stamp to code each photo if possible, and record the ID number from the camera of each photo in the appropriate blank on the form. It is important to set the camera to record in low to medium resolution so that the photos do not take up too much space when downloaded for storage. Ideally, to minimize storage space required, but still allow a reasonable image, each photo would be between 100 and 500 kilobytes in size when downloaded.

You can take and submit to the survey coordinator as many photographs as it takes to thoroughly document the site. Only two photographs from each site can be uploaded to the database. Please ensure that you have one good photo of the inlet taken from upstream of the crossing and another of the outlet taken from downstream of the crossing.

A simple way to know which photos were taken at a particular site is to use a black marker to write the date, crossing ID # and inlet/outlet on a dry-erase board or an 8 ½”X11” paper (waterproof if available). The white board should be strategically placed in the photo to make it legible and to not block key features of the crossings. This will make the photo readily identifiable with the appropriate crossing # and will denote whether the image is of the outlet or inlet of the structure. Some people have noted that white dry-erase boards and white paper reflect so much light that they are often “washed out” in the photos and the codes written on the board impossible to read. Use of a small blackboard and chalk may be preferable depending on light conditions.

ROAD /RAILWAY CHARACTERISTICS

Road surface - Check "Paved," "Unpaved" or "Railroad."

Road type – Check the most appropriate box for the type of road at the crossing location.

1-Lane road – Check this option for one-lane roads and smaller, including cart paths, bike paths, trails, and abandoned rail beds. If the road is greater than 18 feet wide it should be considered a 2-lane road.

2-Lane road – Use this option for typical roads – with or without shoulders/breakdown lanes – that have two travel lanes. Include in this category unpaved roads that are of comparable width to paved, two-lane roads.

Multilane road – This category includes roadways with three or more travel lanes but not divided highways.

Divided highway – Include any divided highway with a total of four or more travel lanes (e.g. two lanes eastbound + two lanes westbound). Any multi-lane (>2 lanes) roadway with a median, vegetated island, Jersey barriers, or guardrails should be considered a divided highway. When travel lanes are separated by a median you can get two crossings (e.g. one for eastbound and one for west bound traffic). Where you have a divided highway but no median you often get a single crossing. In both cases, the road type should be "divided highway."

Railroad – Use this category for rail beds with railroad tracks regardless of how many sets of tracks may be involved. Use "1-Lane road" for abandoned rail beds and rail trails.

Buried Stream – Use this category for a segment of stream that has been buried within a pipe extending well beyond the road crossing itself.

CROSSING / STREAM CHARACTERISTICS – Assess the following for the entire crossing

Crossing type – If a crossing exists at an assessment location check the most appropriate choice among "Ford," "Bridge," "Open bottom arch," "Single culvert" and "Multiple culverts" to identify the crossing type (for additional information see descriptions in the glossary). For an open-bottom box culvert check "Bridge." If there is no crossing at the assessment location check either "Removed" if there was once a structure there that had since been removed or "No crossing" if it appears that there was never a crossing at that location. If you choose the "No crossing" option then it is not necessary for you to fill out the remainder of the data form.

Condition of crossing – Check the appropriate box: "New," "Excellent," "Fair" or "Poor."

Does the stream at the crossing support fish? – Check "Yes" if you see fish or believe that the stream segment at the crossing supports fish. Also check "Yes" if you think that the stream both above and below the crossing supports fish. Check "Not likely" if you think that it is almost certain that the stream segment does not support fish (including fish just passing through). Otherwise check "Don't know."

Is the stream flowing? – Check "Yes" if stream is flowing in the channel upstream and downstream of the crossing. To answer "yes" water in the channel must be moving (even if very slow) and consistent. Puddled areas separated by dry land and rocks does not constitute flow.

Crossing span: Natural streams are variable in width. In selecting the appropriate category consider the average conditions in the natural stream channel outside the influence of the crossing itself.

Bankfull is amount of water that just fills the stream channel and where additional water would result in a rapid widening of the stream or overflow into the floodplain. Indicators of bankfull width include¹:

- Abrupt transition from bank to floodplain. The change from a vertical bank to a horizontal surface is the best identifier of the floodplain and bankfull stage, especially in low-gradient meandering streams.
- Top of point bars. The point bar consists of channel material deposited on the inside of meander bends. Set the top elevation of point bars as the lowest possible bankfull stage.
- Bank undercuts. Maximum heights of bank undercuts are useful indicators in steep channels lacking floodplains.
- Changes in bank material. Changes in soil particle size may indicate the operation of different processes. Changes in slope may also be associated with a change in particle size.
- Change in vegetation. Look for the low limit of perennial vegetation on the bank, or a sharp break in the density or type of vegetation.

Check the appropriate description from the list below.

Severe constriction: The crossing is half as wide, or narrower, than the bankfull width of the natural stream.

Mild constriction: The crossing is narrower than bankfull width in the natural channel upstream and downstream of the crossing but not enough to qualify as a severe constriction.

Spans bank to bank: Choose this option if the crossing spans the bankfull width of the channel, but does not include the banks of the stream.

Spans channel and banks: Choose this option if the crossing structure spans the bankfull channel width and one or more of the banks with sufficient headroom to allow dry passage for some wildlife.

Tailwater scour pool: These are pools created downstream as a result of high flows exiting the crossing. Use as a reference natural pools occurring in a portion of the stream that is outside the influence of the crossing structure and not otherwise altered. A scour pool is considered to exist when its size (a combination of length, width and depth) is larger than pools found in the natural stream. Check "Large" if the width or depth of the pool is twice that of pools in the natural stream channel or more. Otherwise, check either "Small" if a smaller pool exists or "None" if there is no scour pool.

¹ Adapted from Georgia Adopt-A-Stream "Visual Stream Survey" manual. Georgia Department of Natural Resources, 2002.

Crossing alignment matches stream? – Assess crossing alignment at the structure inlet. Use as reference a line connecting the center of the channel where it enters the structure and the center of the channel as it exits the structure. If within 30 feet upstream of the structure the channel deviates from this line by 45 degrees or more check “No (skewed).” If the channel deviates by less than 45 degrees check “Yes (flow aligned).”

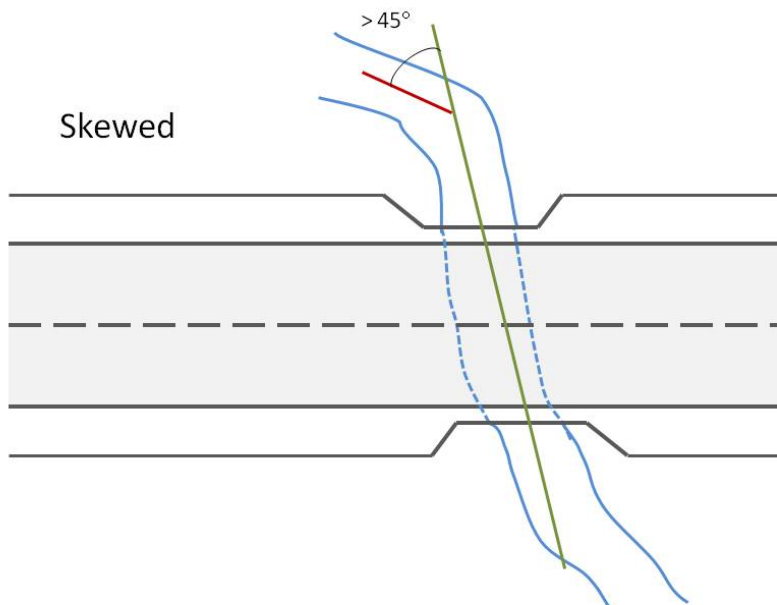
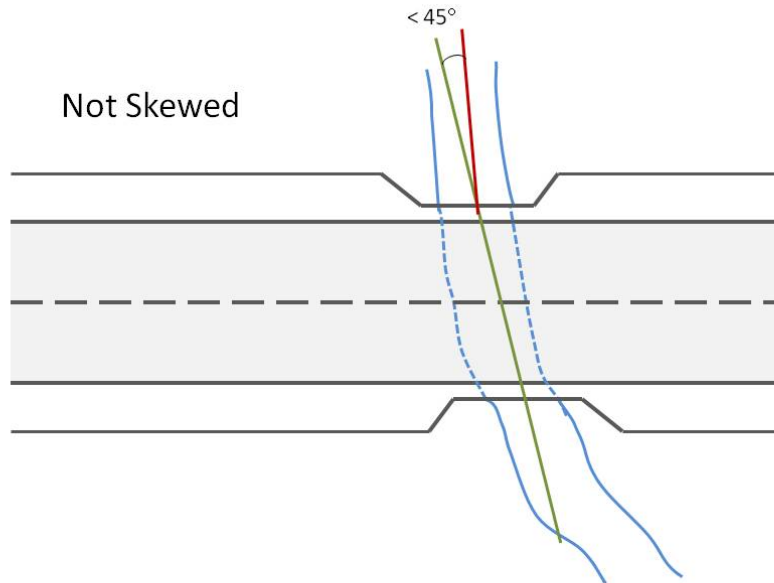

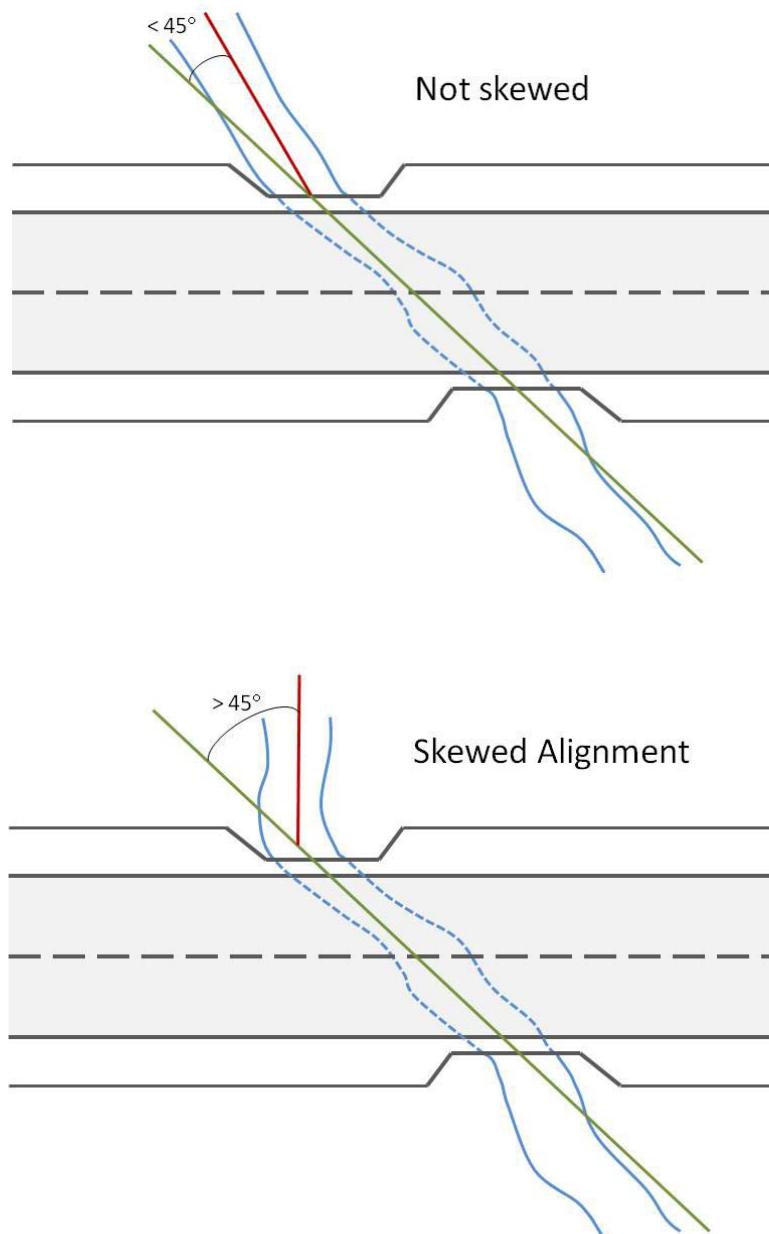

CULVERT/BRIDGE CELL CHARACTERISTICS – Assess the following for each structure that makes up the crossing

Structure embedded?: An embedded culvert is a culvert that is installed in such a way that the bottom of the structure is below the stream bed and there is substrate in the culvert. Indicate on the data form whether or not the culvert is embedded and the degree that the culvert is embedded.

- If the culvert is not buried and generally lacks substrate, then check “Not embedded”.
- If the culvert is partially buried and contains substrate for half or more of its length, check “Partially embedded.”
- If the culvert is buried for its entire length, check “Fully embedded”.
- If the structure has no bottom (bridge, open bottom arch, etc.) or is a ford then check “No bottom.”

Structure substrate: Record whether the substrate in the crossing is “Inappropriate,” “Contrasting,” “Comparable,” or absent (“None”).

- If the culvert is not fully embedded check “None.” If a culvert is only partially embedded then the substrate should be considered “none.”
 - Check “None (smooth)” if the structure bottom lacks corrugations or other roughened conditions
 - Check “None (rough/corrugated)” if the structure bottom is corrugated (e.g. metal or plastic pipe), contains some substrate (but not enough to be considered fully embedded) or is otherwise roughened.
- Large riprap and broken slabs of concrete are examples of substrates that are “Inappropriate” for river and stream continuity.
- Check “Contrasting” if the substrate is not wholly inappropriate, but contrasts with the substrate in the natural stream channel. For example, if the crossing’s predominant substrate is boulders and large cobble on a stream where the natural stream bottom is predominantly mud/muck.
- Check “Comparable” if the substrate in the crossing is similar to that found in the natural stream channel.

Internal features: Check the appropriate box(es) if any of the following features are present within the crossing structure. If no such features are present check “none.”

- Slip lined – Slip lining is when a small liner pipe is inserted into a larger culvert and sealed in place as a way of repairing a crossing without having to replace the structure.
- Baffles/sills – These are low structures that run roughly perpendicular to the flow of water to either reduce velocity or trap/hold sediment. Typically a series of baffles or sills are used within a structure.
- Weirs – Are substantial structures that typically run perpendicular to the flow to back water up (increase depth), reduce velocity or confine low flows to create a channel. One or more weirs might be present within a structure.
- Support structures – Include any internal supports that intercept or interfere with the flow of water.

Physical barriers to fish and wildlife passage: This includes any durable structure that physically blocks fish or wildlife movement. Do not include temporary barriers such as debris or sediment accumulations that are not likely to persist for a number of years. If physical barriers exist at a crossing indicate whether the barrier effect is:

- “Severe” (essentially blocking all fish and wildlife passage),
- “Moderate” (blocking passage for some species or individuals but not others) or
- “Minor” (blocking passage for only a few species or individuals or for only a small proportion of the year) and describe them on the data form.
- Otherwise check “None.”

Is there a clear line of sight through the structure? – Look through the structure if you can see clear through the structure to the other side and check “yes.” Otherwise check “no.”

Does the structure provide dry passage suitable for use by terrestrial wildlife? – Check “yes” if at the time of the assessment the structure provides dry passage with sufficient headroom for semi-aquatic and terrestrial wildlife (e.g. along banks or within the stream channel). Otherwise check

“no.” If “yes” is checked then also record the maximum structure height in the portion of the structure that offers dry passage.

Comments – Add anything you feel may not have been included, but is important for describing the crossing.

Water depth matches stream? – To evaluate water depth use as a reference a portion of the natural stream channel that is outside the influence of the crossing structure and not otherwise altered. Depth is considered comparable if water depths in the crossing are similar to the depths upstream and downstream in the natural stream channel. Comparable means that the depth in the crossing falls within the range of depths naturally occurring in that reach of the stream and for comparable distances. For example a crossing that has water depths that are similar to those found in deeper pool sections of the stream but that extend for longer distances along the stream than do the pools would not be considered comparable. After evaluating the crossing relative to the natural stream check the most appropriate option among “Yes (comparable),” “No (deeper),” “No (shallower)” or “Dry.”

Water velocity matches stream? – To evaluate water velocity use as a reference a portion of the natural stream channel that is outside the influence of the crossing structure and not otherwise altered. Velocity is considered comparable if water velocities in the crossing are similar to the velocities in the nature stream channel upstream and downstream of the crossing. Comparable means that the velocities in the crossing fall within the range of velocities naturally occurring in that reach of the stream and for comparable distances. For example a crossing that has water velocities that are similar to those found in riffle sections of the stream but that extend for longer distances along the stream than do the riffles would not be considered comparable. After evaluating the crossing relative to the natural stream check the most appropriate option among “Yes (comparable),” “No (slower),” “No (faster)” or “Dry.”

Structure Slope matches stream? – To evaluate structure slope use as a reference a portion of the natural stream channel that is outside the influence of the crossing structure and not otherwise altered. Slope is considered comparable if the structure slope is similar to the slopes found in the nature stream channel upstream and downstream of the crossing. Comparable means that the structure slope falls within the range of slopes naturally occurring in that reach of the stream and for comparable distances. For example a structure that has a slope that is similar to that found in short, high-gradient sections of the stream but that extend for longer distances than found in the natural stream would not be considered comparable. After evaluating the structure relative to the natural stream check the most appropriate option among “Yes (comparable),” “No (flatter)” or “No (steeper).”

Length of stream through structure (ft.) Measure the distance from inlet to outlet by walking through the structure if it is large enough and safe to do so. If walking through culvert is not possible, then hold measuring tape at inlet and let current carry it to the outlet where someone else catches it and measure the length. Another option is to estimate length by measuring distance from inlet to outlet on the road above the structure.

Upstream/Downstream Crossing Type – Choose the most appropriate choice from #1-9 or Ford that describes the type of crossing. Record crossing type separately for upstream and downstream portions of the structure. If you have a partially embedded culvert you will have a different culvert type at one end (e.g. round culvert) compared to the other (e.g. embedded round culvert) and will need to record different dimensions.

1.-Open Bottom Arch will look like a pipe culvert on the top half, but you will not see a bottom half. Instead for the bottom, it has metal footings that are sunk into concrete below the stream channel. For recording dimensions a stone arch bridge should be considered an open bottom arch.

2.-Bridge with abutments will have sides at right angles, but no bottom structure.

3.-Bridge with side slopes will have angled sides, and no bottom structure.

4.-Bridge with side slopes and abutments will have both sloping sides as well as sides at right angles to give the bridge height over the stream.

5.-Round Culvert will be a circular pipe. If the culvert typically contains a significant amount of water then choose “Round Culvert Embedded or with Persistent Water” instead.

6. Elliptical Culvert will have a wider, squashed look than a round pipe culvert. If the culvert typically contains a significant amount of water then choose “Elliptical Culvert Embedded or with Persistent Water” instead.

7. Box Culvert will usually be made of concrete.

8. Round Culvert Embedded or with Persistent Water Use this option for a round culvert where the bottom has been buried below the stream channel or for a round culvert that typically contains significant amounts of water, even if not truly embedded.

9. Elliptical Culvert Embedded or with Persistent Water Also known as a “pipe arch” use this option for an elliptical culvert where the bottom has been buried below the stream channel or for an elliptical culvert that typically contains significant amounts of water, even if not truly embedded. If substrate or persistent water is higher than the widest part of the culvert then treat it as a type 1 structure (open-bottom arch).

Ford is a shallow water crossing directly across the streambed, often with logs, stone, or gravel to protect or stabilize the bottom. These are rare, and are mostly found on roads that are not frequently used.

Upstream /Downstream dimensions (ft.) Provide the measurements shown in the appropriate diagram for the crossing type. **(If measurements cannot be taken, please estimate and write EST. after estimated measurement.)**

- A. Measure interior width of crossing at its widest point above the water line at the time of the assessment.
- B. Measure height from underside of crossing to:
 - Water surface or top of bank whichever is higher for bridges, open-bottom arches, and embedded culverts
 - Water surface for box culverts and culverts with persistent water
 - Structure bottom for non-embedded culverts lacking persistent flow
- C. Measure width of actual stream channel (wetted width) through crossing structure if natural bottom exists (i.e. bridges or embedded culverts).
- D. Measure either:
 - The height of vertical abutments from underside of bridge to where sides start sloping (structure type #4) or
 - The height from highest point of the opening to an imaginary line at the widest point of the structure (structure type #9)

If the opening of the culvert is completely submerged under water then check “Submerged.”

Inlet/Outlet Water Depth: Measure (if possible/safe) or estimate the water depth at the deepest point where the stream enters and exits the structure (at edge of structure).

Inlet drop: Where water level drops suddenly at the crossing inlet, causing changes in water speed and turbulence. In addition to the higher velocities and turbulence, these jumps can be physical barriers to fish and other aquatic animals when they are swimming upstream and are unable to swim out of the culvert. Only measure if it is safe to access the pipe, otherwise estimate the drop and check the appropriate box. Measure or estimate the distance that water has to drop to enter the culvert (e.g. from the top of the water in the stream just above the inlet to the top of the water in the culvert at the inlet) and record the measurement (in inches). If there is no inlet drop then check "None."

Outlet Drop: An outlet drop occurs when water drops off or cascades down from the outlet, usually into a receiving pool. This may be due to the original design/construction or subsequent erosion of material at the downstream end of crossing. Outlet drops create barriers to the upstream movement of fish and other aquatic animals that are unable to jump up over the drop. Only measure if it is safe to access the pipe, otherwise estimate the two drop characteristics. Record the measurements (in inches) and check the appropriate boxes (measured or estimated).

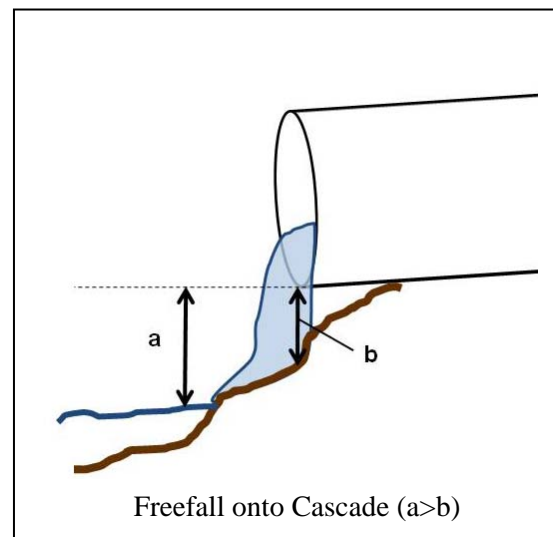
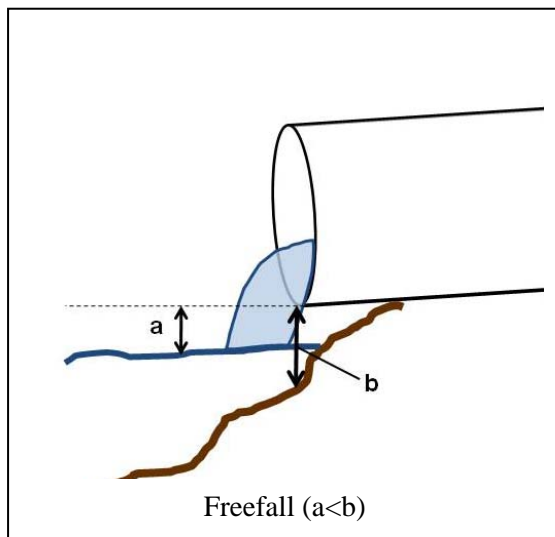
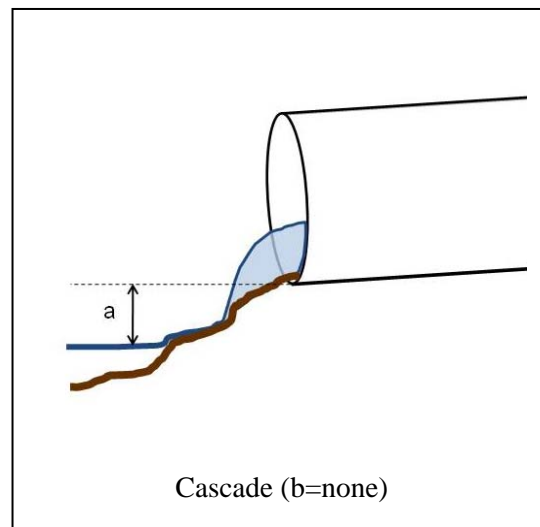
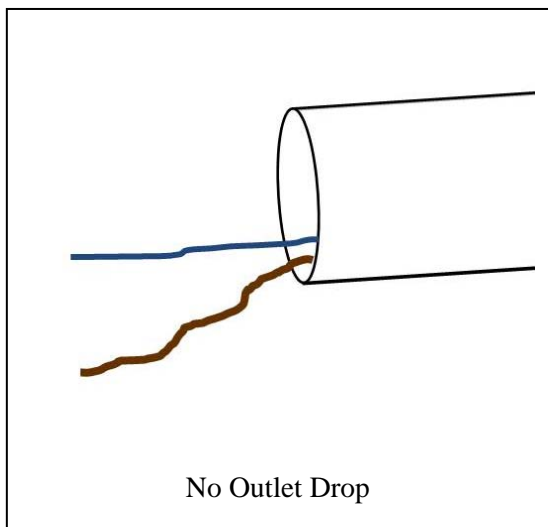

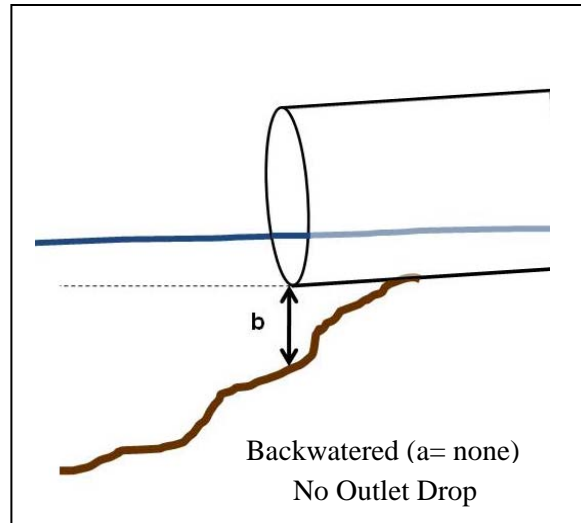

- Culvert bottom to water surface – Measure or estimate the distance from the bottom of the culvert to the water surface in the first pool large enough to provide resting habitat for fish swimming upstream. If there is no outlet drop then check “None.”
- Culvert bottom to stream bed – Measure or estimate the distance from the bottom of the culvert to the bottom of the channel in the stream bed directly below the outlet. If there is no outlet drop then check “None.”
- If there is an outlet drop, check “Cascade” if the water tumbles over rocks, logs, or other debris; or “Freefall”, if the water falls directly into the pool below. Use “Freefall onto cascade” for a combination of characteristics (see illustrations below). If there is no outlet drop then check “No drop.” If the structure is backwatered (see below) check “No drop.”

Armored Streambed at Outlet: This includes concrete aprons, plastic aprons, riprap or other structures added to the *streambed* at the crossing outlet to facilitate flow and prevent erosion. This does not include wing walls, retaining walls, or armored stream banks. Indicate on the data form whether tailwater armoring at the outlet of the crossing is “extensive”, “not extensive” or absent (“none”). Armoring is considered extensive if it covers the entire width of the channel at the outlet and extends downstream for a length equal to or greater than half the bankfull width of the natural stream.

MULTIPLE CULVERT OR BRIDGE CELL CROSSINGS

When inventorying multiple culverts or bridge cells, label left culvert/cell #1 and go in increasing order from left to right from downstream end (outlet) looking upstream. Record data for culvert/cell #1 on pages 1 and 2 of the data sheet. Use page #3 for additional culverts or cells.

Culvert or Bridge Cell #: Record the culvert/cell number.

Record Data: Follow the same instructions as above to complete data on page #3.

Glossary

- **Bankfull Width** – Bankfull is amount of water that just fills the stream channel and where additional water would result in a rapid widening of the stream or overflow into the floodplain. Indicators of Bankfull width include:
- Abrupt transition from bank to floodplain. The change from a vertical bank to a horizontal surface is the best identifier of the floodplain and Bankfull stage, especially in low-gradient meandering streams.
 - Top of pointbars. The pointbar consists of channel material deposited on the inside of meander bends. Set the top elevation of pointbars as the lowest possible Bankfull stage.
 - Bank undercuts. Maximum heights of bank undercuts are useful indicators in steep channels lacking floodplains.
 - Changes in bank material. Changes in soil particle size may indicate the operation of different processes. Changes in slope may also be associated with a change in particle size.
 - Change in vegetation. Look for the low limit of perennial vegetation on the bank, or a sharp break in the density or type of vegetation.
- **Bridge** – A crossing structure typically consisting of abutments and a deck spanning the stream.
- **Culvert** – Round, elliptical or rectangular structures that are fully enclosed (contain a bottom) designed primarily for channeling water beneath a road, railroad or highway.
- **Embedded Culvert** – A culvert that is installed in such a way that the bottom of the structure is below the stream bed and there is substrate in the culvert.
- **Ford** – Modified or unmodified portions of a stream or river where vehicle drive through rather than over the streambed. Vented fords provide culverts to pass water during low flows while higher flows pass over the ford.
- **Inlet drop** – Where water level drops suddenly at an inlet, causing changes in water speed and turbulence. In addition to the higher velocities and turbulence, these jumps can be physical barriers to fish and other aquatic animals when they are swimming upstream and are unable to swim out of the culvert.
- **Open Bottom Arch** – An arched crossing structure that spans all or part of the stream bed, typically constructed on buried footings and without a bottom.
- **Open Bottom Box Culvert** – A pre-cast box culvert with no bottom that spans all or part of the stream bed. Difficult to distinguish from a bridge.
- **Openness ratio** – Equals cross-sectional area of the structure divided by crossing length when measured in feet. For a box culvert, openness = (height x width)/ length.
- **Outlet drop** – An outlet drop occurs when water drops off or cascades down from the outlet, usually into a receiving pool. This may be due to the original culvert placement or erosion of material at the downstream end of culvert. Outlet drops are barriers to fish and other aquatic animals that can't jump to get up into the culvert.

- **Physical barriers to fish and wildlife passage** – Any structure that physically blocks fish or wildlife movement as well as structures that would cause a culvert to become blocked. Beaver dams, debris jams, fences, sediment filling culvert, weirs, baffles, aprons, and gabions are examples of structures that might be or cause physical barriers. Weirs are short dams or fences in the stream that constrict water flow or fish movements. Baffles are structures within culverts that direct, constrict, or slow down water flow. Gabions are rectangular wire mesh baskets filled with rock that are used as retaining walls and erosion control structures.
- **Pipe Arch** – A pipe that has been factory deformed from a circular shape such that the width (or span) is larger than the vertical dimension (or rise), and forms a continuous circumference pipe that is not bottomless.
- **Tailwater armoring** – Concrete aprons, plastic aprons, riprap or other structures added to culvert outlets to facilitate flow and prevent erosion.
- **Tailwater scour pool** – A pool created downstream from high flows exiting the culvert. The pool is wider than the stream channel and banks are eroded.

Designing a Culvert Management System for the Town of Spencer, MA

Structural Condition Assessment for Culverts

Invert Deterioration

Good



No visual damage or only superficial corrosion or scaling of the invert.¹

Fair



Minor corrosion and pitting, no holes or distortion. Cannot penetrate metal with sharp point of geology hammer. Minor isolated spalls in concrete.¹

Poor



Perforations visible and/or connection hardware failing (metal). Heavy abrasion and scaling with exposed steel reinforcement (concrete). Heavy abrasion or scour damage (plastic). Displaced mortar and/or blocks, holes in invert area (masonry).²

Critical

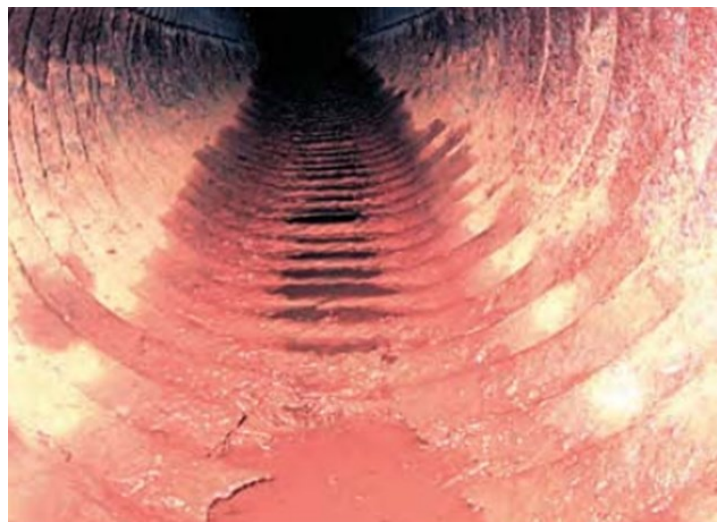

Holes or section loss with extensive voids beneath invert and/or embankment/roadway damage. Holes and gaps with extensive infiltration of soil, bedding, or backfill material (masonry).²

Joints & Seams

Good



Joints and seams are tight with no openings.¹

Fair



Minor separation of joints and seams up to 1", minor backfill infiltration.¹

Poor



Significant separation of joints and seams between 1" to 3"; infiltration of backfill into culvert; voids visible in fill through offset of joints.¹

Critical



Severe separation of joints and seams greater than 3"; infiltration of backfill into culvert; large voids visible in fill through offset of joints.¹

Cracking (Concrete)

Good



No visual evidence of cracking, or only minor hairline cracking at isolated locations, or minor scaling of invert.¹

Fair



Longitudinal cracks less than 1/8" in width, spalls up to 1/4" deep.¹

Poor



Longitudinal cracks between 1/8"-1/4" in width, spalls larger than 1/2" deep, and spalls have exposed rebar.¹

Critical



Severe cracking and spalls greater than 1/2" on culvert walls, sections of culvert are partially collapsed, major corrosion of rebar.¹

Cracking (Metal)

Good

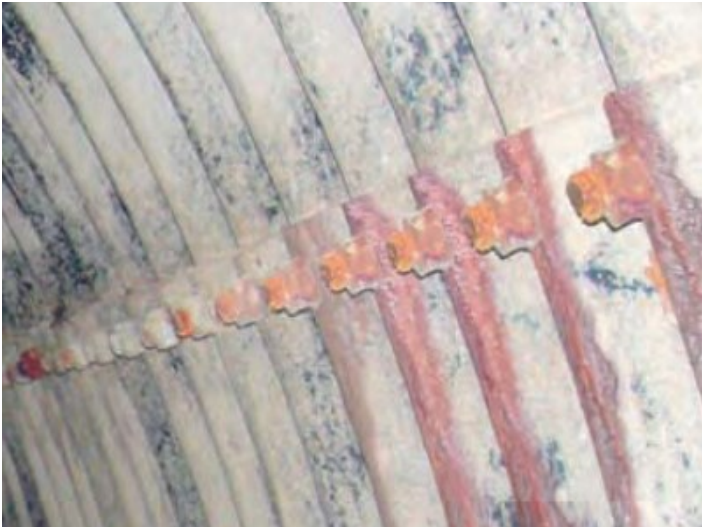

No visual evidence of cracking along bolt holes or seams.¹

Fair



Minor cracking around bolt holes or seams at isolated sections.¹

Poor



Significant cracking and/or deterioration along bolt holes and isolated seams of plates.¹

Critical



Severe cracking and or deterioration along bolt holes and along seams of plates.¹

Cracking (Plastic)

Good



No visual evidence of damage, cracking, or rips in the culvert material.¹

Fair



Minor isolated rip or tear caused by debris less than 6" in length and 1/2" in width. Minor cuts or gouges to end sections from maintenance or construction activities.¹

Poor



Cracking, splits or tears over 6" in length and up to 3/4" in width. Openings in pipe causing loss of backfill material.¹

Critical



Cracking, splits, punctures, or tears over 6" in length and over 1" in width. Openings in pipe causing loss of backfill material.¹

Cracking (Masonry)

Good



Little or no deterioration. Masonry may have minor weathering (mortar joints are sound). Joints have no leakage.³

Fair



Minor to moderate deterioration. Masonry may have moderate weathering or cracking (mortar joints may have minor deterioration). Joints may have minor separation, misalignment, or leakage.³

Poor



Extensive deterioration, but the function or structural capacity of the culvert has not been significantly impaired. Masonry may have weathering or cracking. Joints may have significant separation, misalignment, or leakage (there may be evidence of backfill infiltration).³

Critical



Culvert has severe or critical deterioration. Function or structural capacity of the culvert has been severely impacted—immediate repairs or structural analysis may be required. Masonry may have severe weathering or spalling. Joints may have severe misalignment or leakage.³

Headwall/Wingwall

Good



Little or no cracking, rotation, or displacement. Light concrete scaling, metal corrosion, or other surface deterioration.⁴

Fair



Minor cracks and spalls in concrete. Minor rotation and/or displacement with gap in barrel seam. Minor footing exposure.⁴

Poor



Area affected by cracking and spalling is >50% and/or rebar exposed. Significant displacement at cracks or wall rotation causing a gap at the wall-to-barrel interface >4". Footing exposed and undermined.⁴

Critical



Partially or totally collapsed, with resultant damage to embankment and/or roadway damage.⁴

Apron

Good



No cracking, piping, or undermining.⁴

Fair



Minor cracking but no visible piping or undermining.⁴

Poor



Significant cracking affects >50% of apron.
Significant piping or undermining.⁴

Critical



Partially or totally collapsed, significantly effecting performance and/or causing embankment and/or roadway damage.⁴

Pipe Damage

Good



No signs of flow through embankment on outside of culvert barrel.¹

Fair



Embankment moist only in areas surrounding culvert barrel. No evidence of flow or sediment transport observed.¹

Poor



Evidence of seepage through the embankment along the outside of the culvert barrel, sediment transport not observed.¹

Critical



Evidence of flow through embankment along the outside of culvert barrel. Evidence of sediment transport observed.¹

Scour

Good



No visual evidence of culvert undermining or exposed footings. Only minor scour hole is present. Culvert span to scour hole depth ratio is greater than 10.¹

Fair



Minor undermining of the culvert barrel or top of footing is exposed. Culvert span to scour hole depth ratio is between 5 to 10.¹

Poor



Significant undermining of the culvert barrel or undermining of the footing. Culvert span to scour hole depth ratio is between 2 to 5.¹

Critical



Extensive undermining of the culvert barrel or footing. Culvert span to scour hole depth ratio is less than 2.¹

Cross-Section Deformation (Concrete)

CONCRETE	CULVERT SIZES						
	12"	24"	36"	48"	60"	72"	84"
GOOD	< 12 ^{1/8}	< 24 ^{1/4}	< 36 ^{3/8}	< 48 ^{1/2}	< 60 ^{3/4}	< 72 ^{3/4}	< 85
FAIR (1% - 5%)	12 ^{1/8} - 12 ^{1/2}	24 ^{1/4} - 25 ^{3/16}	36 ^{3/8} - 37 ^{3/4}	48 ^{1/2} - 50 ^{1/4}	60 ^{3/4} - 63	72 ^{3/4} - 75 ^{1/2}	85 - 88 ^{1/4}
POOR (5% - 10%)	12 ^{1/2} - 13 ^{1/4}	25 ^{3/16} - 26 ^{3/8}	37 ^{3/4} - 39 ^{1/2}	50 ^{1/4} - 52 ^{3/4}	63 - 66	75 ^{1/2} - 79 ^{1/4}	88 ^{1/4} - 92 ^{1/2}
CRITICAL (>10%)	> 13 ^{1/4}	> 26 ^{3/8}	> 39 ^{1/2}	> 52 ^{3/4}	> 66	> 79 ^{1/4}	> 92 ^{1/2}

Good	No visual evidence of flattening of invert and/or crown. Barrel has smooth symmetrical curvature. ¹
Fair	Minor distortions isolated within the pipe resulting in flattening of invert and/or crown. Isolated sections are slightly non-symmetrical. Span dimension is within 1-5% of design. ¹
Poor	Significant distortions within the pipe resulting in flattening of invert and/or crown of pipe. Span dimension is within 5-10% of design. ¹
Critical	Severe distortions and deflection within the pipe; flattening of the crown or invert; structure is partially collapsed. Span dimension is greater than 10% of design. ¹

Cross-Section Deformation (Metal)

METAL	CULVERT SIZES						
	12"	24"	36"	48"	60"	72"	84"
GOOD	< 12 ^{1/2}	< 25 ^{3/16}	< 37 ^{3/4}	< 50 ^{1/4}	< 63	< 75 ^{1/2}	< 88 ^{1/4}
FAIR (5% - 15%)	12 ^{1/2} - 13 ^{3/4}	25 ^{3/16} - 27 ^{1/2}	37 ^{3/4} - 41 ^{1/2}	50 ^{1/4} - 55 ^{1/4}	63 - 69	75 ^{1/2} - 82 ^{3/4}	88 ^{1/4} - 96 ^{1/2}
POOR (15% - 20%)	13 ^{3/4} - 14 ^{1/2}	27 ^{1/2} - 28 ^{3/4}	41 ^{1/2} - 43 ^{1/4}	55 ^{1/4} - 57 ^{1/2}	69 - 72	82 ^{3/4} - 86 ^{1/2}	96 ^{1/2} - 101
CRITICAL (>20%)	> 14 ^{1/2}	> 28 ^{3/4}	> 43 ^{1/4}	> 57 ^{1/2}	> 72	> 86 ^{1/2}	> 100

Good	No visual evidence of flattening of invert and/or crown. Barrel has smooth symmetrical curvature. ¹
Fair	Minor distortions isolated within the pipe resulting in flattening of invert and/or crown. Isolated sections are slightly non-symmetrical. Span dimension is within 5-15% of design. ¹
Poor	Significant distortions within the pipe resulting in flattening of invert and/or crown of pipe. Span dimension is within 15-20% of design. ¹
Critical	Severe distortions and deflection within the pipe; flattening of the crown or invert; structure is partially collapsed. Span dimension is greater than 20% of design. ¹

Cross-Section Deformation (Plastic)

PLASTIC	CULVERT SIZES						
	12"	24"	36"	48"	60"	72"	84"
GOOD	< 12 ^{1/2}	< 25 ^{3/16}	< 37 ^{3/4}	< 50 ^{1/4}	< 63	< 75 ^{1/2}	< 88 ^{1/4}
FAIR (5% - 10%)	12 ^{1/2} - 13 ^{1/4}	25 ^{3/16} - 26 ^{3/8}	37 ^{3/4} - 39 ^{1/2}	50 ^{1/4} - 52 ^{3/4}	63 - 66	75 ^{1/2} - 79 ^{1/4}	88 ^{1/4} - 92 ^{1/2}
POOR (10% - 15%)	13 ^{1/4} - 13 ^{3/4}	26 ^{3/8} - 27 ^{1/2}	39 ^{1/2} - 41 ^{1/2}	52 ^{3/4} - 55 ^{1/4}	66 - 69	79 ^{1/4} - 82 ^{3/4}	92 ^{1/2} - 96 ^{1/2}
CRITICAL (>15%)	> 13 ^{3/4}	> 27 ^{1/2}	> 41 ^{1/2}	> 55 ^{1/4}	> 69	> 82 ^{3/4}	> 96 ^{1/2}

Good	No visual evidence of distortions within the pipe. Barrel has smooth symmetrical curvature. Pipe deflection up to 5% from original shape. ¹
Fair	Minor isolated distortions and dimpling within the pipe. Pipe deflection 5-10% from original shape. ¹
Poor	Significant distortions; wall buckling; flattening of invert/crown throughout the pipe. Pipe deflection 10-15% from original shape. ¹
Critical	Severe distortions; wall buckling; flattening of invert/crown throughout the pipe; cracking/tearing present. Pipe deflection greater than 20% of original shape. ¹

Longitudinal Alignment

Good



Angle measured from upstream channel to centerline of culvert barrel is from 0-15 degrees.¹

Fair



Angle measured from upstream channel to centerline of culvert barrel is from 15-45 degrees.¹

Poor



Angle measured from upstream channel to centerline of culvert barrel is from 45-75 degrees.¹

Critical



Angle measures from upstream channel to centerline of culvert barrel is larger than 75 degrees.¹

Footing

Good



Little or no deterioration. Concrete - minor cracking, leaching, or scaling. Masonry - minor weathering (joints are sound). No footing exposed.³

Fair



Minor to moderate deterioration. Concrete - moderate cracking, scaling or leaching (minor delamination or spalling). Masonry - moderate weathering (minor joint deterioration). Slight settlement or undermining. Minor footing exposure.³

Poor



Extensive deterioration. Concrete - extensive cracking, scaling or leaching (delamination or spalling may be prevalent). Masonry - extensive weathering (significant joint deterioration). Significant settlement or undermining. Footing exposed and undermined.³

Critical



Severe or critical deterioration. Function or structural capacity of the culvert has been severely impacted - immediate repairs or structural analysis may be required. Concrete - severe cracking, scaling, delamination, or spalling. Masonry - severe weathering (failed joints or displaced masonry blocks) Severe settlement or undermining.³

Roadway Over Culvert

Good

Fair



Pavement has no visible defects, small cracks, or maintenance patches.¹

Minor isolated cracking and spalled areas.¹

Poor

Critical



Significant cracking, spalling, potholes, or maintenance patches affecting up to 20% of any single travel lane or shoulder.¹

Extensive cracking, spalling, potholes, or maintenance patches affecting 20% or more of any single travel lane or shoulder.¹

Blockage at Inlet

Good



Blockage occupies less than 10% of opening.¹

Fair



Blockage occupies 10-30% of opening.¹

Poor



Blockage occupies 30-75% of opening.¹

Critical



Blockage occupies >75% of opening.¹

Embankment

Good



No noteworthy deficiencies which affect the condition of the embankment protection.¹

Fair



Riprap starting to wash away, minor erosion, and embankment protection is in need of minor repairs.¹

Poor



Embankment protection is severely undermined causing significant erosion of embankment and should be reviewed for repairs.¹

Critical



Embankment protection has failed causing severe scour of embankment and threatening the stability of the roadway embankment.¹

Sources

¹Trevis, Robert E., P.E. "Culvert Inspection & Inventory Field Handbook." (n.d.): n. pag. Oregon Department of Transportation, 13 Mar. 2013. Web. 1 Feb. 2015.

²Culvert Condition Assessment Form provided by Scott Jackson

³Wilson, Pete. "Culvert Inspection, Condition Ratings & Inventory Coding." (n.d.): n. pag. Minnesota Department of Transportation. Web. 1 Feb. 2015

⁴Hunt, John H., Stephen M. Zerges, Brian C. Roberts, and Bart Bergendahl. "Culvert Assessment and Decision-Making Procedures Manual For Federal Lands Highway." (n.d.): n. pag. Federal Highway Administration, Sept. 2010. Web. 1 Feb. 2015.

Appendix E – Infill Calculations

Rank	Culvert #	Road	Inlet_Structure	Fill above culvert (ft)	Length (ft)	Width (ft)	Infill (ft ³)
1	8	SS	Round Culvert	1	32	1	32
2	2	SS	Round Culvert	1	40.58	1	41
3	4	SS	Round Culvert	1	34	1.2	41
4	5	SS	Round Culvert	1	32.66	1.66	54
5	1	SS	Round Culvert Embedded	1	37.08	2	74
6	3	SS	Round Culvert	2	34.33	1.2	82
7	7	SS	Round Culvert	4	32	1	128
8	9	SS	Round Culvert	2	34	2	136
9	16	NS	Round Culvert	4	31	2	248
10	17	NS	Round Culvert	4	40	2	320
11	6	SS	Box Culvert	8	32	2	512
12	11	SS	Box Culvert bridge	2	26.75	12	642
13	22	NS	Round Culvert	10	48	2.5	1,200
14	19	NS	Bridge with Abutments	2	38.5	17.1	1,317
15	10	SS	Box Culvert	8	42	4	1,344
16	14	MR	Round Culvert	8	60	3	1,440
17	15	NS	Box Culvert bridge	2	32	24	1,536
18	18	NS	Round Culvert	6	129	2.6	2,012
19	13	MR	Round Culvert Embedded	15	43.5	4	2,610
20	20	NS	Round Culvert	30	120	2	7,200
21	21	NS	Round Culvert	40	100	2.5	10,000
22	12	Rt 9	Box Culvert bridge	15	68	12	12,240

Appendix F – Instructions for viewing results on River and Stream Continuity Database

1. Navigate to https://www.streamcontinuity.org/cdb2/search_crossings.cfm
2. In the Search module, input Massachusetts as the State and Spencer as the Town. Press Search.
3. The database will display 22 records for the Town of Spencer.
 - a. To view individual crossings, click on the crossing code coordinate.
 - b. To view a map of the crossings, click on map results.
 - c. To view an Excel sheet containing the data for each crossing, click on simple or detailed in the export section.
 - d. To export a map of the crossings that can be used with other programs, click on Shapefile in the export section.

STRUCTURAL ASSESSMENT FIELD DATA FORM

Date: _____ Technicians: _____ Weather: _____ Road: _____ Town: _____

GPS Coordinates: _____ Other Location Notes: _____

NOTE THIS FORM SHOULD BE COMPLETED USING THE STRUCTURAL ASSESSMENT PACKET AS A REFERENCE

	Good (1.00)	Fair (0.67)	Poor (0.33)	Critical (0.00)	Unknown	N/A
Invert Deterioration	<input type="checkbox"/>	<input type="checkbox"/>	<input type="checkbox"/>	<input type="checkbox"/>	<input type="checkbox"/>	<input type="checkbox"/>
Joints & Seams	<input type="checkbox"/>	<input type="checkbox"/>	<input type="checkbox"/>	<input type="checkbox"/>	<input type="checkbox"/>	<input type="checkbox"/>
Cracking	<input type="checkbox"/>	<input type="checkbox"/>	<input type="checkbox"/>	<input type="checkbox"/>	<input type="checkbox"/>	<input type="checkbox"/>
Headwall/Wingwall	<input type="checkbox"/>	<input type="checkbox"/>	<input type="checkbox"/>	<input type="checkbox"/>	<input type="checkbox"/>	<input type="checkbox"/>
Apron	<input type="checkbox"/>	<input type="checkbox"/>	<input type="checkbox"/>	<input type="checkbox"/>	<input type="checkbox"/>	<input type="checkbox"/>
Pipe Damage	<input type="checkbox"/>	<input type="checkbox"/>	<input type="checkbox"/>	<input type="checkbox"/>	<input type="checkbox"/>	<input type="checkbox"/>
Scour	<input type="checkbox"/>	<input type="checkbox"/>	<input type="checkbox"/>	<input type="checkbox"/>	<input type="checkbox"/>	<input type="checkbox"/>
Cross-section deformation	<input type="checkbox"/>	<input type="checkbox"/>	<input type="checkbox"/>	<input type="checkbox"/>	<input type="checkbox"/>	<input type="checkbox"/>
Longitudinal alignment	<input type="checkbox"/>	<input type="checkbox"/>	<input type="checkbox"/>	<input type="checkbox"/>	<input type="checkbox"/>	<input type="checkbox"/>
Footing	<input type="checkbox"/>	<input type="checkbox"/>	<input type="checkbox"/>	<input type="checkbox"/>	<input type="checkbox"/>	<input type="checkbox"/>
Roadway over Culvert	<input type="checkbox"/>	<input type="checkbox"/>	<input type="checkbox"/>	<input type="checkbox"/>	<input type="checkbox"/>	<input type="checkbox"/>
Blockage at Inlet	<input type="checkbox"/>	<input type="checkbox"/>	<input type="checkbox"/>	<input type="checkbox"/>	<input type="checkbox"/>	<input type="checkbox"/>
Embankment	<input type="checkbox"/>	<input type="checkbox"/>	<input type="checkbox"/>	<input type="checkbox"/>	<input type="checkbox"/>	<input type="checkbox"/>

Performance Problems:

Additional Comments:

Structural Condition Score: