

WPI

Low Ambient Air Source Heat Pumps Utilizing Cascade Cycles

A Major Qualifying Project Report:

Submitted to the Faculty of the:

WORCESTER POLYTECHNIC INSTITUTE

In partial fulfillment of the requirements for the degree of Bachelor of science

by

Stephan Barthold

Brandon Cohen

Michelle Hull

Tyler Wilson

Date: April 15th, 2019

Approved by:

Professor Robert Daniello, Major Advisor

Professor Christopher Scarpino, Major Advisor

Table of Contents:

Section 1.0 Abstract	4
Section 2.0 Acknowledgments	5
Section 2.0 Background	6
Section 2.1 Heat Pump Cycle	6
Section 2.2 Types of Heat Pumps	8
Section 2.2.1 Ductless Mini-Splits	8
Section 2.2.2 Water Source	9
Section 2.2.3 Air Source	10
Section 2.2.4 Ground Source	10
Section 2.3 Refrigerants	11
Section 2.4 Compressors	12
Section 2.5 Low Ambient Conditions	13
Section 2.6 Previous Research	14
Section 2.6.1 Variable Refrigerant Flow	15
Section 2.6.2 Cascade Cycle	15
Section 2.7: Proposed Research	16
Section 3.0 Test Plan and Methodology	17
Section 3.1 Cascade Cycle Refrigerant Selection	18
Section 3.2 Pre-Test Preparations	21
Section 3.3 EES Modeling	22
Section 3.3.1 State Point 1	23
Section 3.3.2 Compression	23
Section 3.3.3 State Point 2	24
Section 3.3.4 Condensing	24
Section 3.3.5 State Point 3	25
Section 3.3.6 Evaporating	25
Section 3.3.7 State Point 4	25
Section 3.4 Testing	26
Section 3.5 Refrigeration Diagram 1: Valve Locations	27
Section 3.6 Refrigeration Diagram 2: Thermocouple locations	28
Section 4.0 Results	29
Section 4.1 Data	29
Section 4.2 Trends in Data	30
Section 4.3 EES Code Model	31
Section 5.0 Conclusion and Recommendations	33

Section 6.0 Appendices	35
6.1 3/19/2019 Test Data	35
6.2 4/1/2019 Test Data	36
6.3 Master Test Data	38
6.4 Unit Nameplate	40
6.5 Unit Set Up	41
Section 6.6 Fans Speeds (fpm)	44
Section 6.7 EES Code	45
Section 7.0 References	48
Section 1.0 Abstract	4
Section 2.0 Acknowledgments	5
Section 2.0 Background	6
Section 2.1 Heat Pump Cycle	6
Section 2.2 Types of Heat Pumps	8
Section 2.2.1 Ductless Mini-Splits	8
Section 2.2.2 Water Source	9
Section 2.2.3 Air Source	10
Section 2.2.4 Ground Source	10
Section 2.3 Refrigerants	11
Section 2.4 Compressors	12
Section 2.5 Low Ambient Conditions	13
Section 2.6 Previous Research	15
Section 2.6.1 Variable Refrigerant Flow	15
Section 2.6.2 Cascade Cycle	15
Section 2.7: Proposed Research	16
Section 3.0 Test Plan and Methodology	18
Section 3.1 Cascade Cycle Refrigerant Selection	19
Section 3.2 Pre-Test Preparations	22
Section 3.3 EES Modeling	23
Section 3.3.1 State Point 1	24
Section 3.3.2 Compression	24
Section 3.3.3 State Point 2	25
Section 3.3.4 Condensing	25
Section 3.3.5 State Point 3	26
Section 3.3.6 Evaporating	26
Section 3.3.7 State Point 4	26

Section 3.4 Testing	27
Section 3.5 Refrigeration Diagram 1: Valve Locations	28
Section 3.6 Refrigeration Diagram 2: Thermocouple locations	29
Section 4.0 Results	30
Section 4.1 Data	30
Section 4.2 Trends in Data	31
Section 4.3 EES Code Model	32
Section 5.0 Conclusion and Recommendations	34
Section 6.0 Appendices	36
6.1 3/19/2019 Test Data	36
6.2 4/1/2019 Test Data	37
6.3 Master Test Data	39
6.4 Unit Nameplate	41
6.5 Unit Set Up	42
Section 6.6 Fans Speeds (fpm)	45
Section 6.7 EES Code	46
Section 7.0 References	49

Section 1.0 Abstract

The goal of this project was to determine if the addition of a cascade cycle to a commercial air to air source heat pump would increase the efficiency of the unit in low ambient temperatures. This project explores heat capacities and efficiencies of heat pumps as temperatures drop below 25 °F. The testing acquired anemometer and thermocouple readings and simulated the effects of a cascade cycle on an R-410a Trane 5 ton Precedent Heat Pump unit utilizing a scroll compressor and normal operating conditions of 45/130/15 (saturated suction temperature/ saturated discharge temperature/degrees of superheat) at 3-phase nominal voltage 208-240V. Engineering Evaluation Software (EES) was utilized to simulate the heat pump model with and without the cascade cycle.

Section 2.0 Acknowledgments

Our team would like to thank our advisors, Professor Robert Daniello and Christopher Scarpino for their guidance. We would also like to thank our sponsor Trane and our contact Lane Liudahl for their donation of the heat pump unit as well as Mr. Liudahls continued support in providing insight and information for our project. Without the help of our advisors and sponsor, this project would not have been possible to coordinate or complete. We would like to extend our sincerest gratitude to them for their continued support.

Section 2.0 Background

Section 2.1 Heat Pump Cycle

The need for a device able to control the temperature of an enclosed space has existed since the expansion of highly populated facilities and buildings. The conception of the heat pump arose from this necessity. Heat pumps are more efficient than both electrical and combustible means of heating. Electrical heating devices use large amounts of energy to produce thermal heat. A refrigeration cycle adds creates similar heat using less electrical power. Gas and combustible heat sources use a lot of natural resource to function and have adverse effects to the environment. A heat pump utilizes thermodynamic properties to increase its efficiency. While in the process of heating, a heat pump is a device that applies work to heat energy in the opposite direction of ideal gas conditions, which states areas of a higher temperature and pressure naturally disperse to areas of lower pressure and temperature and vice versa. The purpose of a heat pump is to use electrical energy to pump thermal energy opposite to its natural state. Heat pump systems are reversible and can act as both a cooling unit as well as a heating source. Heat pump units occupy two different spaces; one where thermal energy is consumed and one where it is dissipated; (indoor and outdoor environment (Wiley, 2017)). The space that loses energy is cooled and the space which gains energy is heated. Operating in areas of varying pressures and temperatures creates a load on the system and work must be done to account for the pressure differential created between spaces.

To operate, the device utilizes the principles of thermodynamics to dissipate heat to a desired area. The first law of thermodynamics states that energy through a system will be conserved. This law holds true based upon the law of the conservation of energy, which states that energy cannot be created nor destroyed. Theoretically, in a heat pump system, the energy flow into the system is equivalent to the energy flow out of the system. In practice, energy is lost due to a combination of mechanical, hydraulic, and volumetric efficiencies. Efficiency loss is derived from factors such as friction in the pump, working fluid property restrictions, and the effect of hydraulic flow rate on pipe friction (Wiley, 2017). Energy is added to a heat pump by electrical power delivered by a compressor. The continuous addition of electrical energy to the system translates into work provided by the pump. In order to achieve the transfer of thermal

energy across two areas, a heat pump will operate following the model of the Carnot refrigeration cycle.

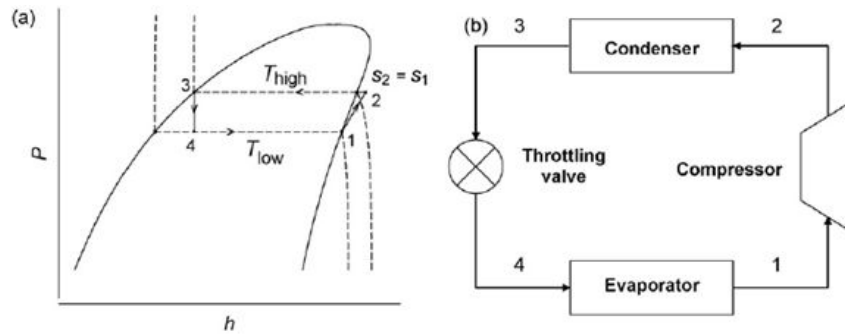

Figure 1: Ideal Refrigeration Cycle (Figuroa-Gerstenmaier et al., 2007)

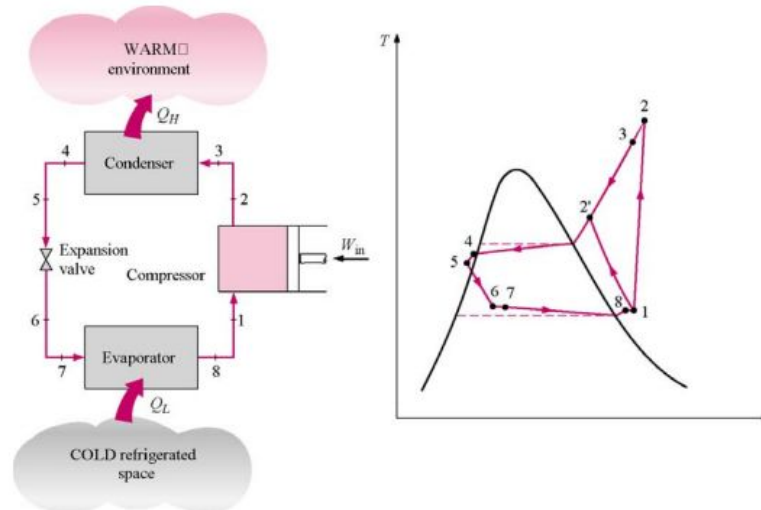

Figure 2: Actual Refrigeration Cycle (Figuroa-Gerstenmaier et al., 2007)

To heat or refrigerate a given area, a working fluid with a low boiling point is used in a series of pipes to collect thermal energy from the surrounding area. The working fluid is known commonly as a refrigerant and exists in different forms, each with varying properties. The series of pipes that collect thermal energy is commonly known as the evaporator. Increasing surface area of piping helps to make this component more efficient in energy collection. The evaporator can collect energy from ground, air, or water surroundings by means of heat transfer properties (A Dictionary of Energy Science, 2017). The thermal energy collected from surroundings boils the refrigerant, creating a higher temperature vapor. This vapor is then compressed by the compressor to a higher pressure and temperature. The pressurized vapor then travels to the

condenser, which dissipates the thermal energy from the vapor to the conditioned space. This loss of thermal energy condenses the refrigerant to a liquid. The refrigerant then travels to the expansion valve, which lowers pressure in the system. In an ideal cycle with no friction and heat loss, this process is known as isentropic expansion. Isentropic expansion is both adiabatic and reversible. A non-ideal cycle, which is one that the heat pump follows, undergoes isenthalpic expansion. The isenthalpic process means that the cycle has no change in specific enthalpy in the system.

The process of condensing a working fluid to a higher pressure and temperature then dissipates the thermal energy to reach a lower pressure and temperature is known as the Carnot cycle. The working fluid then travels to the evaporator. In modern heat pump units, a reversing valve exists after the compressor. The purpose of the reversing valve is to redirect the flow of refrigerant in the system. (MassCEC, 2015).

For example, a low-pressure low-temperature working fluid leaving the valve is redirected to the heat exchanger in the conditioned space to collect heat and dissipate to the outdoor environment. By reversing the direction of the fluid, the evaporator used in the heating cycle acts as the condenser and vice versa (K.J Chua, S.K Chou and W.M Yang, 2010). These systems also include a fan on both the evaporator and condenser for surrounding air to pass through the system faster. The flow of air aids the heat convection in both components.

Section 2.2 Types of Heat Pumps

Although the refrigeration cycle for heat pumps is generally the same, there are many types of heat pumps, all making use of the same basic thermodynamic cycle, but differing in their packaging and installation in a building. They vary by the method they remove/dissipate heat into a conditioned space. This can be through mediums such as air, water, direct contact with the conditioned space or geothermal energy (Consumer Reports, 2018).

Section 2.2.1 Ductless Mini-Splits

One type of heat pump that is ideal for single room additions or spaces without ductwork, called ductless mini-splits. The compressor and condenser tubing section (when in cooling mode) are outside the conditioned space, while the evaporator tubing section is located inside the conditioned space. When in heating mode, the reversing valve is activated and the

condenser becomes the evaporator and the evaporator becomes the condenser, with the evaporator and condenser outside and inside the conditioned space, respectively. This is called a ductless mini split because it does not require ductwork and is 'split' between the inside and outside of the conditioned space, much like a split direct expansion refrigeration system. These are used when ductwork will not fit in the space available for installation, such as apartment buildings (Compact Appliance, 2015).



Figure 3: Ductless Mini Split from “Ductless Solutions | Ductless Air Conditioner | VRF, Multi and Mini Split | Trane Commercial HVAC.” Trane-Commercial

Section 2.2.2 Water Source

Heat pumps that utilize water to transport heat are called water source heat pumps. These units utilize refrigerant-to-water heat exchangers. These systems require less refrigerant line and refrigerant charge, have high efficiencies and less CO₂ emissions than conventional heating systems. The downside to these types of system is the need for a water loop, as the water source needs to be close to the conditioned space (Hepbasli & Kalinci, 2009).

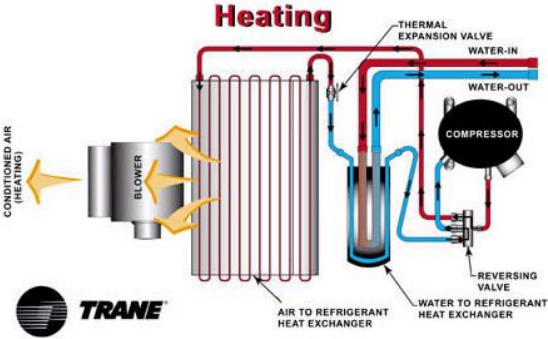

Figure 4: Trane water source heat pump from Luther, Robb. “Heat Pumps.” NaturalGasEfficiency.org

Section 2.2.3 Air Source

The most common method of heat transfer is through air source heat pumps. These units utilize outside air as a mode of heat transfer. Air source heat pumps have low fuel costs, water and space heating, minimal maintenance, lower carbon emissions, and easy installation in comparison to ground source heat pumps. These pumps work by utilizing refrigeration lines that absorb heat from ambient air. The refrigerant then goes through the vapor compression cycle and either transfers this heat to a water loop or to an air handling unit that ducts conditioned air to the conditioned space (MassCEC, 2015).

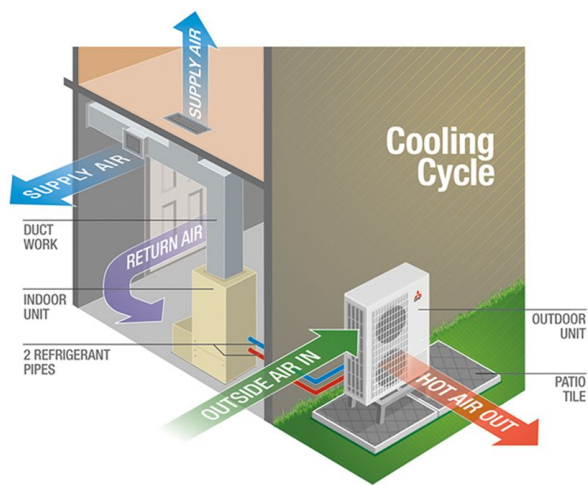

Figure 5:. Air source heat pump from Sankrityayan, Rahul. “Air Source Heat Pump Market Categories By Product, Application and Regional Outlook - 2024.” The Camping Canuck, 10 May 2018

Section 2.2.4 Ground Source

Ground source heat pumps utilize pipes buried in soil to take in heat from the ground and supply it to radiators, radial floor heating, forced hot air heating, or hot water. The ground loop, filled with a refrigerant or fluid that carries heat into the evaporator, is buried underground, absorbs heat from the ground and passes through a heat exchanger. The advantage of these systems lies in the relatively uniform ground temperatures that allow the heat pump to continue working even as outdoor air temperatures become cold. The evaporator temperature provides the limiting cold temperature in a vapor compression heat pump cycle. These units require minimal maintenance, additional hot water heating, and lower carbon emissions. The

disadvantage of this type of heat pump is that the ground loop is costly to install and requires a large amount of space (Mustafa Omer, 2008).

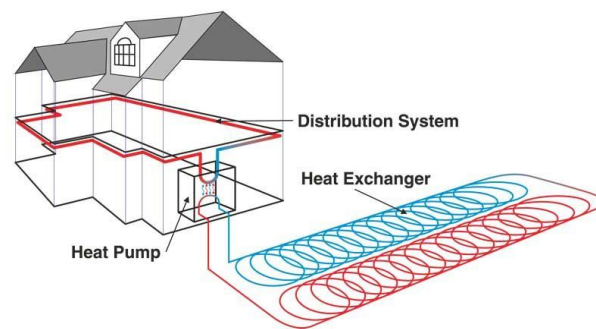

Figure 6: Ground source heat pump from “Is This Ground-Source Heat Pump Plan Workable?”
GreenBuildingAdvisor, 8 Aug. 2018

Section 2.3 Refrigerants

While refrigeration systems vary in the way they transfer heat and conditioned air, they also differ in the working fluid used to do so. Many refrigerants have been invented, used, and discontinued based on system design, size, cost, system performance, safety, reliability, and serviceability, as well as regulations put in place by the Environmental Protection Agency (EPA) (EPA, 2016).

One of the first refrigerants was water, dating back to 3000 B.C. Water was used in the first continuous refrigeration system by William Cullen in 1755 until he discovered ethyl ether, which was used in Jakob Perkins’ invention of vapor compression refrigeration system. Ethyl Ether, however, was not an ideal refrigerant due to its toxicity, flammability, and high normal boiling point, and more refrigerants followed to avoid these issues (Kharagpur, 2008). Some of the common refrigerants used in modern heat pump technology are R-134a, R407c, R600, R744 (CO₂), and R410a, with R410a being the most common for small to medium sized units that both heat and cool (Kharagpur, 2008). The selection of the right refrigerant for the application based on temperature and pressure requirements greatly impacts the efficiency of the heat pump.

Refrigerant	Pressure at 15 °C [bar a]	Pressure at 70 °C [bar a]	Pressure ratio [bar a / bar a]	Heat of evaporation at 70 °C [kJ/kg]	Density at 15 °C [kg/m ³]
R134a	4,9	21,2	4,3	124	23,8
R407c	7,5	35,0	4,7	107	31,9
R600 (n-butaan)	1,8	8,1	4,5	307	4,5
R600a (isobutaan)	2,6	10,9	4,2	269	6,8
R717 (NH ₃)	7,3	33,1	4,5	939	5,7
R410A*	12,5	47,7	3,8	45	48,0
R744 (CO ₂)	50,9	Critical temperature is 31 °C			160,7

* Critical temperature R410A is 71 °C

Figure 7: Frequently used Refrigerants from De Kleijn Energy Consultants and Engineers. “Refrigerants for Heat Pumps.” Industrial Heat Pumps, 2019.

Section 2.4 Compressors

Another major consideration in heat pump design is the type of compressor that is suitable for the application. There are many different types of compressors including reciprocating, rotary, scroll, screw, and centrifugal that compress the working fluid. The most common type of compressor for modern air-air source heat pumps is the scroll compressor due to its high efficiency, long service life, and low operating noise when compared to other compressor types. Scroll compressors consist of two scrolls; one remaining fixed and the other rotating around the other. As fluid enters the compressor, it is sucked in between the two scrolls and is continuously forced into a smaller and smaller area by the rotating scroll. By the time the fluid reaches the middle of the scrolls, a large amount of compression has occurred, and the fluid is ready to continue through the cycle (Macmichael, 2013).

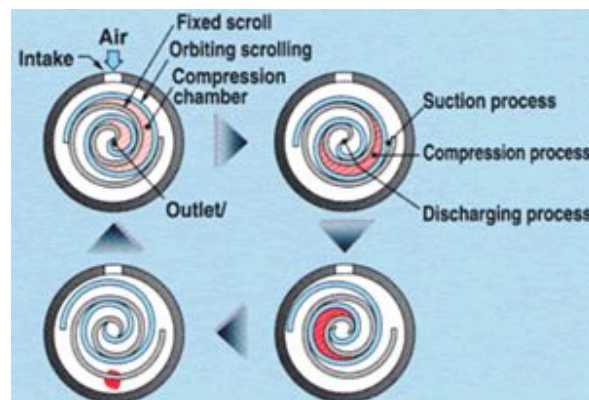

Figure 8: Rotary Scroll Compressor from Aermerch. “Rotary Scroll Compressor.” Aermerch 2015.

Section 2.5 Low Ambient Conditions

Some air source heat pumps (ASHP) have the capability of working in climates as low as -15°F or colder utilizing supplemental heating such as electric heat. When supplemental heating is used the ASHPs consume more energy and are not able to take advantage of the COP of the vapor compression cycle. Eventually the ASHP will not be able to produce air temperature warm enough on its own. 25°F is a common cut off point where the heat pump switches to an additional heating source. Recent developments have worked towards maximizing the electrical efficiency in colder climates. The efficiency is measured by the electrical use (btu/hr) and the Coefficient of Performance (COP) vs the outside temperature. COP is the ratio of heating and cooling to work required. By providing a supplemental source, the ASHP can successfully run in cooler climates. Thermal storage solutions, electrical furnaces, and baseboard heating are examples of additional heating sources (Brown, Burke-Scoll, & Stebnicki, 2011).

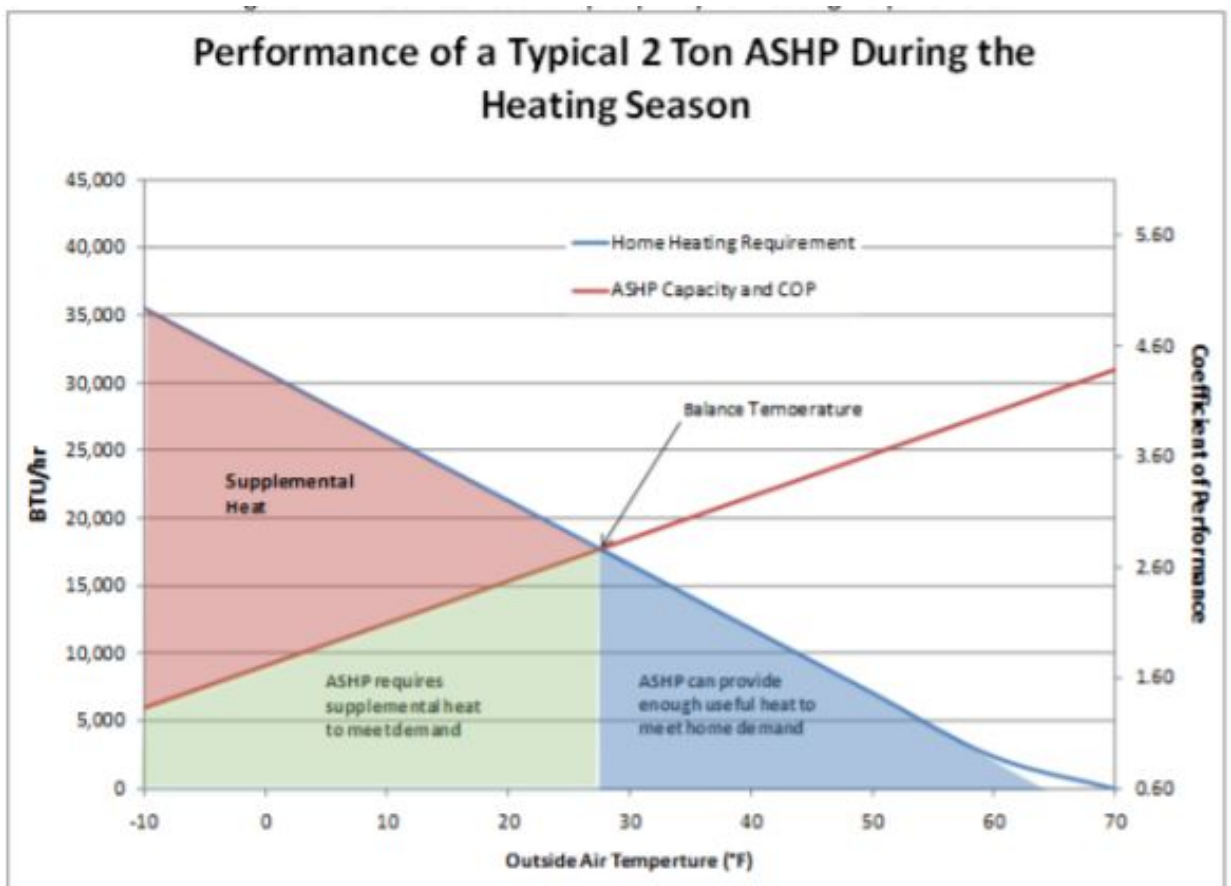

Figure 9 - Air source Heat Pump Capacity vs Heating Requirements (Brown, Burke-Scoll, & Stebnicki, 2011 pp. 7)

By using ASHP, consumers can benefit in energy savings compared to conventional home heating systems. Installation is easier and requires low maintenance compared to GSHP. This provides a cheaper solution. When comparing COP, typically a gas or electric furnace will have a COP of 1 or less while a ASHP can show anywhere from 2.3 or more (Kohler and Lewis, 2008). Although ASHP are more efficient, there are downfalls when compared to traditional heating systems. In cooler climates, there is less effect due to the lowered COP. One study done by Franklin Energy shows the typical performance of a ASHP during the heating season. The purpose of this study was to compare the energy savings of supplemental heating in addition to ASHP in lower ambient temperatures followed by a 12 week in-home testing and data collection.

As shown, when temperatures begin to cool, the COP drops. Once the outside temperature reaches about 27°F the heat pump can no longer provide a “satisfactory temperature,” which in this study is about 95°F. The pumps that do not have supplemental heating source may take more time to heat up and stay on constantly throughout the winter. This may cause the pump to become noisy through wear and tear. Homes using ASHP must be well insulated to avoid heat loss. (Liu & Hong, 2010)

Section 2.6 Previous Research

There have been proposed solutions in order to avoid the lower capacity in cooler climates. A study done by the US Department of Energy investigated the energy performance of a dual compressor low ambient ASHP. The dual compressor systems' purpose is to minimize the supplemental electrical heating. The heat pump has four modes, each using the compressors differently depending on the outside temperature. This differs from a typical heat pump that has one or two modes. This study was done over the course of two heating seasons (19 months) in Connecticut. It was found that little to no supplemental heating was required. Most usage of the electrical heating (mode 4) was to defrost the coils and was only activated in temperature below 12°F. (R.K. Johnson, 2013)

Section 2.6.1 Variable Refrigerant Flow

Variable Refrigerant Flow heat pumps are another solution that includes several features to increase efficiency. They typically used in electric systems with variable speed compressors and fans, expansion valves, and refrigerant used for heat transfer. This allows for the ability to control the amount of refrigerant sent to each area which improves temperature control, increases the performance in lower temperatures, and allows more sustainability of the compressor. The conventional heat pump switches to additional heating supplements after the cut-off. VRF heat pumps are able to operate at temperatures below 0°F. Daikin and Mitsubishi make low ambient heat pumps that use Refrigerant 410a. These systems use variable refrigerant volume and inverted compressors to provide a high COP (Kohler and Lewis, 2008).

Section 2.6.2 Cascade Cycle

As previously stated, providing supplemental heating can be essential to improving efficiency at low ambient conditions. One method of providing this supplemental heat is by adding a cascade cycle.

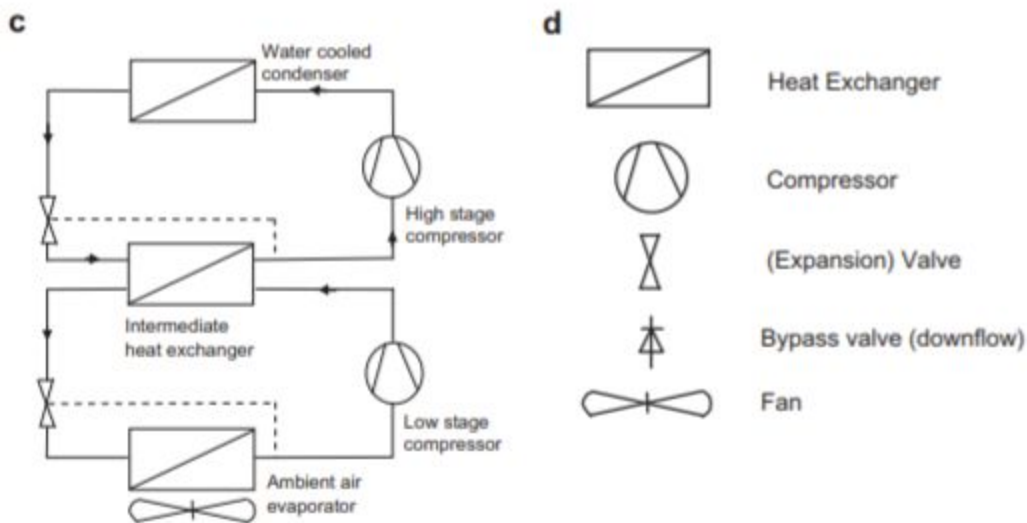

Figure 10: Cascade cycle with legend (Chua, Chou, & Yang, 2010)

Cascade systems are contain two or more separate refrigeration cycles dedicated to different temperature ranges, evenly distributing the load to increase efficiency across a broader

range of temperatures. Each cycle contains refrigerants most suitable for its dedicated temperature range to absorb the most heat from the surroundings. The cycles are then coupled together with an intermediate heat exchanger to transfer heat to the next stage of the system. Cascade cycles have been found to improve the efficiency of heat pumps by upwards of 20% (Chua, Chou, & Yang, 2010).

This efficiency improves the stability of the air heating operations with a higher overall outlet temperature when compared to single stage heat pumps. One key component of a cascade cycle's improved efficiency is the intermediate heat exchanger connecting multiple cycles together. Previous research determined that the optimal performance temperature is determined by measurements of the condensing and evaporating temperatures, difference in temperatures and the efficiency of the independent cycles (Qu et al., 2017).

Section 2.7: Proposed Research

Previous research indicates that heat pump technology in all conditions has advanced significantly through the years, however, it still suggests there is room for improvement in low ambient conditions. While both cascade cycles and VRF were options for this project, the cascade cycle was much simpler to model, therefore we chose to focus on the addition of a cascade cycle. The cascade system requires two cycles to both run continuously, something that is not energy efficient. An issue this project aims to tackle is to increase the coefficient of performance for Trane R410A 5 ton heat pumps in low ambient temperatures using a cascade cycle. Utilizing a second evaporator on the main cycle, throttling valves will control the flow of refrigerant to either evaporator depending on ambient temperatures. A smaller cascade cycle with an alternative refrigerant that boils at a lower temperature than R410A will share its condenser heat exchanger box with this second main cycle evaporator, rejecting heat from this second cycle condenser to the throttled refrigerant in the second main cycle evaporator. By increasing the temperature in this evaporator, the delta T across the first main cycle evaporator will increase.

Section 3.0 Test Plan and Methodology

This test simulated the effects of a cascade cycle on an R-410a Trane 5 ton Precedent Heat Pump unit utilizing a scroll compressor and normal operating conditions of (insert saturated suction temperature here)/(insert saturated discharge temperature here)/(insert degrees of superheat here) at 3-phase nominal voltage 208-240V. Engineering Evaluation Software (EES) was utilized to simulate the heat pump model with and without the cascade cycle. The unit was be altered to simulate a cascade cycle.

1. Step 1: Research
 - a. Cascade Cycles
 - i. Effective flow rates and operating temperatures
 - ii. Size of system and feasibility
 - iii. Efficiency value added to the system
 - b. Refrigerants for cascade cycle
 - i. Ideal operating temperatures for low ambience
 - ii. Compatibility with normal cycle
 - iii. Accessibility and price
 - iv. Non conventional refrigerants
2. Step 2: Pre-Test Preparations
 - a. Create cart to mobilize and store unit with
 - i. Must be mobile and strong
 - ii. Match the dimensions of the given unit curb
 - iii. Keep the unit from sliding off
 - b. Create Labview program to read thermocouples
 - i. Determine where to take these readings
 - ii. Map out delta values
 - c. Figure out heat source to recreate 2nd heat exchanger in EES
 - i. How to trap the heat
 - ii. Best approach to the most successful transfer between coils
 - d. Install Instrumentation
 - i. 10 Type T thermocouples
 - ii. Pressure taps

3. Step 3: EES Modeling
 - a. Model a normal operation heat pump
 - b. Operate Trane heat pump, compare to MQP model
 - c. Configure model to align with Trane heat pump
 - d. Utilize ASHRAE literature; charts and curves
4. Step 4: Testing
 - a. Test Trane unit at normal operating conditions at various setpoints
 - b. Test Trane unit at low ambient conditions at various setpoints
 - c. Test Trane unit with simulated cascade cycle

Section 3.1 Cascade Cycle Refrigerant Selection

In order to quantify the effectiveness of a proposed cascade cycle, the power consumption of the device must be lessened by the addition of the cascade cycle. This cycle can either contain the same refrigerant as the main cycle or a different refrigerant. A refrigerant with properties that favor low temperature working conditions utilized in the cascade cycle that is paired with the existing 410a refrigerant cycle would have an advantage, as both refrigerants can work in their optimum design range (Purdue 2006).

Alternative refrigerants are a widely researched field as environmental regulations continue to become prominent in the field. A few examples of natural alternatives to conventional refrigerants being researched include propane, isobutene, and ammonia. To be effective as an alternative refrigerant, the power consumption of the heat pump while using an alternative refrigerant must be comparable to the power consumption of a traditional refrigerant such as R410A (Bengtsson 2016). The instrumentation required to remove, store and measure these alternative refrigerants are out of the scope for this current project, however the properties of these substances can be applied theoretically.

Propane (R290) and Isobutene (R600) are used as alternative refrigerants in small range applications such as air conditioners, but they are unsuitable for use in commercial heat pumps because of its flammable properties (Linde 2019). Ammonia is a suitable working fluid with a boiling point of -28 degrees Celsius, however there are many complications while trying to use it as an alternative refrigerant. Ammonia must be kept as pure as possible in order for it to be a feasible working fluid. Systems such as our heat pump could easily contaminate the ammonia with either oil or consistent charges to the fluid, leading to system failure. This makes ammonia

expensive to maintain as well as a financial risk for any company using this refrigerant (OSHA 2019). For this project, exploring the possibilities of ammonia would require a complete overdrive of modern refrigeration systems in order to assure feasible use in the system.

While natural refrigerants are an option, we also must consider refrigerants in the current market, such as R407C, R410A and R134A. A study by Bertsch & Groll at the International Refrigeration and Air Conditioning Conference at Purdue analyzed a cascade cycle system consisting of two R410A cycles. While this was considered by our team, the study concluded that a cascade cycle containing the same refrigerant “greatly reduces the potential of the system (Bertsch & Groll, 2006),” and a system with different refrigerants would have an advantage, as both refrigerants can work in their optimum design range (Bertsch & Groll, 2006).

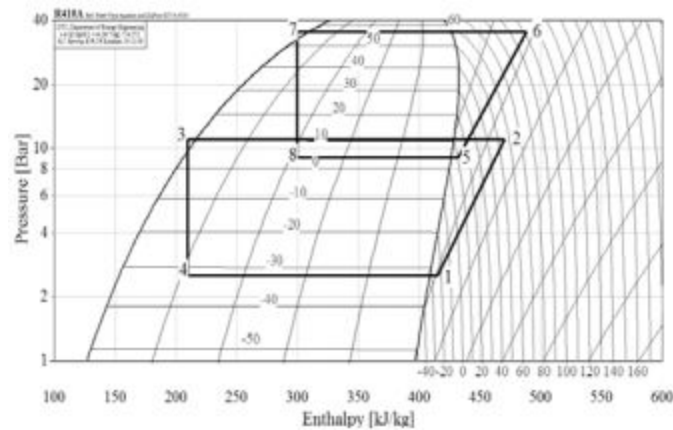

Figure 11: Pressure-enthalpy diagram of a main and cascade cycle (R410a) (Bertsch & Groll, 2006)

A study by Ali Tarrad of the Asian Journal of Engineering and Technology on cascade cycles in heat pumps analyzed the performance of two systems; 410A/134A and 407C/134A. The table and figures below give the properties of these refrigerants and the heat load-temperature results from the study. This study concluded that R410A was a better choice over R407C due to its evaporation and condensation heat transfer coefficient characteristic, which allows for a smaller surface area than R407C, despite R410A's higher operating pressure. It also showed that the “best thermal performance was obtained at 28.4 °F and 158 °F for LT evaporator and HT condenser temperatures respectively for the whole range of intermediate temperature. It is ranged between 35.96 and 37 for intermediated temperature in

the range of 83.3 °F to 102.2 °F . The best performance can be achieved in the intermediate temperature range close to 91.4°C to 98.6 °C” (Tarrad 2017). The “best thermal performance” is referring to the highest COP for the best intermediate temperature produced between both sides of the cascade heat exchanger. This data was especially helpful to our project, since we are working with R410A as the main cycle refrigerant. This led us to test R134A in our EES software as the cascade cycle refrigerant.

Property	R-407C	R-410A	R134a
Composition and Refrigerant (Formula)	R32/125/134a (23/25/52) % by Weight	R32/125 (50/50) % by Weight	CF3CH2F (100) %
Molecular Weight (kg/kmol)	86.2	72.58	102.03
Normal Boiling Point (°C)	-43.4	-51.58	-26.06
Temperature Glide (°C)	7.4	<0.2	0
Critical Pressure (MPa)	4.62	4.926	4.0603
Critical Temperature (°C)	86.2	72.13	101.08
Ozone Depletion Potential	0	0	0.005
Global Warming Potential	1600	1725	1430

Table 1: Physical Properties for Refrigerants (Tarrad, 2017)

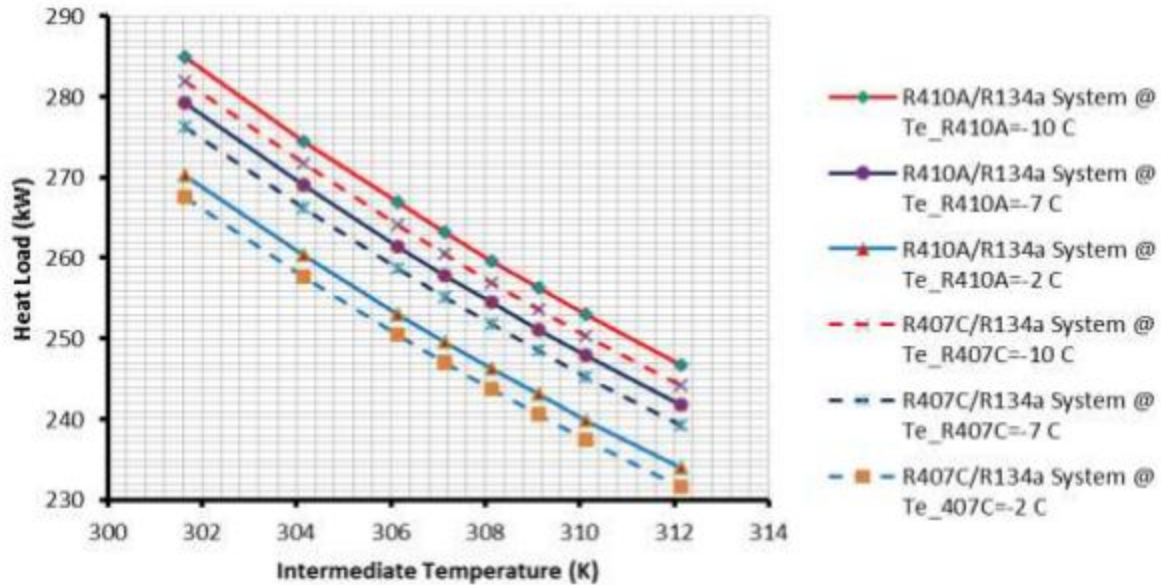

Figure 12: High Temperature cycle condensation (75°C) (Tarrad, 2017)

The physical addition of the cascade cycle is beyond the scope of our project, so the cascade cycle must be simulated in some way on the existing unit. In this system, the heat rejected by the condenser of the cascade cycle is absorbed by the evaporator of the main

refrigeration cycle, creating a load on the evaporator. This heat is then rejected to the conditioned space by the condenser of the main cycle. To simulate this load on our project, we blocked sections of the evaporator. This is reflected by the EES program we created.

Section 3.2 Pre-Test Preparations

Prior to testing a cart needed to be created to move the unit to the necessary location for data collection. The cart was constructed to match the dimensions of the given roof curb and support the weight for storage purposes. The data collection took place outside the storage where a power outlet could be reached. This area was sufficient to provide the ambient air for testing. Thermocouples and pressure gauges gave the team data measurements for temperature and pressures. These locations were chosen based on the predicted changes in pressure and temperature throughout refrigeration cycle.

The heat pump unit was fitted with six Schrader valve fittings which were installed by Trane. The location of these valves can be seen in Refrigeration diagram 1. The Schrader valves were fitted with refrigerant hoses and a high pressure gauge so that measurements at these points can be used in the EES code. The refrigerant hoses and gauges are all compatible with 410a, assuring the safety in testing.

In addition to pressure readings, temperature readings were recorded using type T thermocouples. Prior to collecting data, the team connected thermocouples using thermal conductive epoxy and insulation. The location of these thermocouples can be seen in Refrigeration diagram 2. The data for the thermocouples was planned to be processed by a LabView program code and collected using a 16 bit processor, however, due to time and resource limitations, the data was collected using a handheld thermocouple reader. Since the unit was steady state, it was possible to take reliable data in this way. The temperature measurements allowed for a greater understanding of the machines overall performance and were used in the EES program to help determine the coefficient of performance.

Controlling power to the heat pump was a thermostat from which operational output temperature can be set. In addition, it gave the reading for the ambient temperature used in analyzing data. The thermostat can also dictate whether the pump is in either heating or cooling mode and the operation of the evaporator fan.

The air velocity was measured using a handheld anemometer. The face velocity of the fan is used to calculate the cubic feet per minute (CFM) of the air, allowing the team to determine the heat output of the unit in BTU/hr.

Section 3.3 EES Modeling

To model the unit, Engineering Equation Solver (EES) software was used. Below are diagrams showing an ideal and actual refrigeration cycle and corresponding points used in EES.

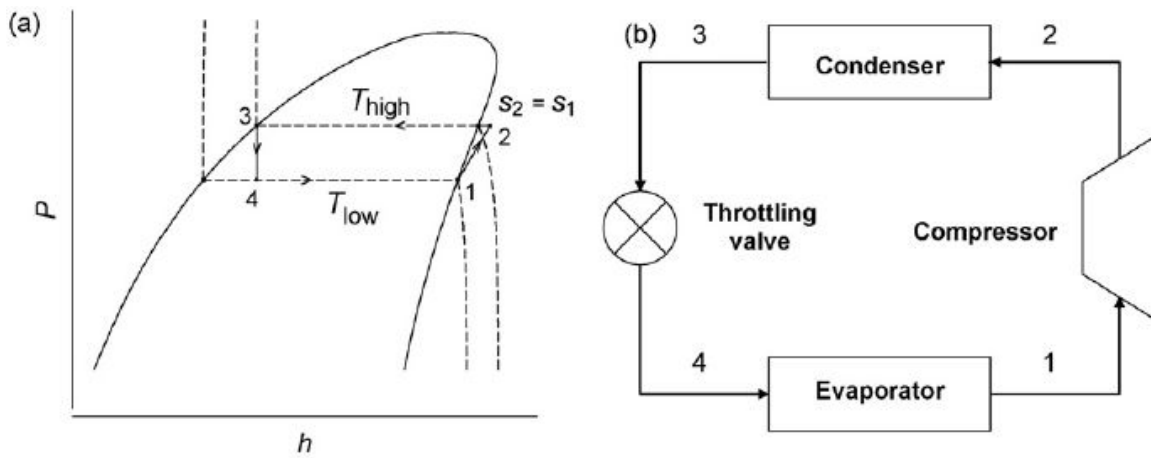

Figure 13: Ideal Refrigeration Cycle (Figueroa-Gerstenmaier et al., 2007)

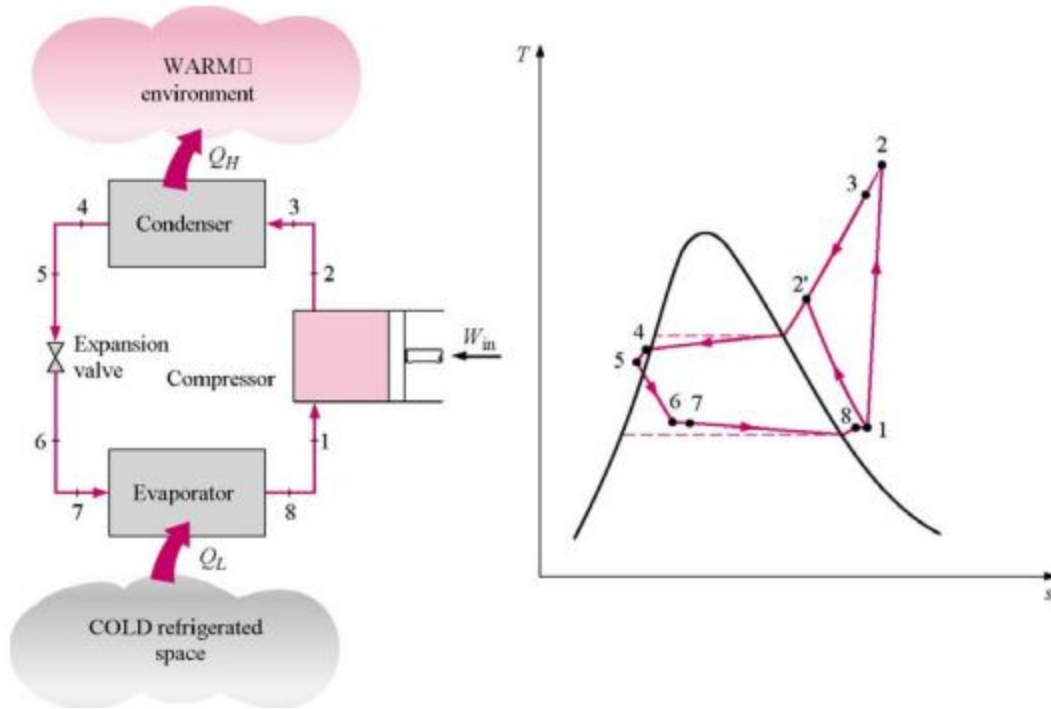

Figure 14: Actual Refrigeration Cycle (Figueroa-Gerstenmaier et al., 2007)

Section 3.3.1 State Point 1

State Point 1 was set as an initial condition with Temperature and Pressure given from experimental data.

Section 3.3.2 Compression

The working fluid goes through compression from state point 1 to state point 2. Trane provided coefficients for a ten term Polynomial Equation produced by ASHRAE that provides mass flow rate and electrical work of the compressor as a function of suction and discharge saturation temperatures. The saturation temperatures were set by pressures at state point 1 and state point 2. Pressure at state point one was given by experimental data. Pressure at state point 2 was calculated as a function of pressure at state point one, as there is a high correlation in compression ratio with varying conditions.

$$X = C1 + C2 \cdot (tS) + C3 \cdot (tD) + C4 \cdot (tS^2) + C5 \cdot (tS \cdot tD) + C6 \cdot (tD^2) + C7 \cdot (tS^3) + C8 \cdot (tD \cdot tS^2) + C9 \cdot (tS \cdot tD^2) + C10 \cdot (tD^3)$$

When comparing the calculated mass flow rate to Trane's modeled mass flow rate for the given experimental conditions, it was determined that an iterative method was required instead of the polynomial equation due to large discrepancies leading to inaccurate heat transfers. A simplified heat cycle was produced in EES with the experimental conditions and compared to the results of Trane's model. A series of mass flow rates were tested until all the calculated heat transfers converged with Trane's model.

Section 3.3.3 State Point 2

State point 2 was set by a given temperature from experimental data and pressure being calculated as described in the compression section. Entropy and enthalpy could be determined because the working fluid is a superheated vapor after compression, and therefore temperature and pressure can set the state since it lies outside the saturation dome.

Section 3.3.4 Condensing

The working fluid passes through the condenser from state point 2 to state point 3 where heat is rejected by the refrigerant and absorbed by the supply air. Trane provided experimental data and curves from which heat rejected by the condenser could be calculated as a function of air velocity across the condenser. The air velocity was taken as an average of points across the face, with 16 points being sampled. Heat rejected from the working fluid as it changes state from a superheated vapor to a saturated liquid is calculated using the following equation:

$$Q_{vtp} = \text{Condenser Characteristic} * [1.08 * A * (T_{sat,P2} - T_{InsideAir})]$$

Where,

$$\text{Condenser Characteristic} = f(\text{Air Velocity})$$

The heat rejected from the working fluid as it becomes a subcooled liquid was calculated as a function of effectiveness (esc), which was also determined by air velocity.

$$Q_{sc} = m_{dot} * Cp * ESC * (T_{sat,P2} - T_{InsideAir})$$

Where,

$$ESC = f(\text{Air Velocity})$$

The total heat rejected by the working fluid was the sum of the heat from superheated vapor to saturated liquid and the heat of subcooling.

$$Q_{cond} = Q_{vtp} + Q_{sc}$$

Section 3.3.5 State Point 3

State Point 3 was set using pressure and enthalpy based on the heat rejected by the condenser. To determine the pressure, an isobaric heat exchange was assumed across the condenser:

$$P_3 = P_2$$

To determine the enthalpy, the following equation was used:

$$Q_{cond} = m_{dot} * (h_2 - h_3)$$

Where,

$$h_3 = h_2 - \frac{Q_{cond}}{m_{dot}}$$

Section 3.3.6 Evaporating

Instead of solving for State Point 4 by modelling the thermodynamics passing through the thermostatic expansion valve (TXV), Trane provided Evaporator data and curves to solve for State Point 4 by working backwards from State Point 1. As the working fluid passes through the evaporator from State Point 4 to State Point 1, heat is gained by the working fluid from the outside air. The data provided by Trane allowed the heat transfer coefficient (K) to be calculated as a function of air velocity passing across the evaporator. The heat gained by the working fluid was then calculated using the equation for net total heat (NTQ).

$$Q_{evap} = NTQ = Area * K * LMTD$$

Where,

$$LMTD = \frac{T_{AirIn} - T_{AirOut}}{LN\left(\frac{T_{AirIn} - TSE}{T_{AirOut} - TSE}\right)}$$

$$K = f(Air\ Velocity)$$

Section 3.3.7 State Point 4

State Point 4 was set using temperature and enthalpy based on the heat gained across the evaporator. To determine the temperature, a superheat of 15 [F] was assumed after the evaporator. To determine the enthalpy, the following equation was used:

$$Q_{evap} = m_{dot} * (h_1 - h_4)$$

Where,

$$h_4 = h_1 - \frac{Q_{evap}}{m_{dot}}$$

Section 3.4 Testing

Unit testing was split into multiple sessions throughout the months of March and April to ensure a wide range of ambient temperatures and weather conditions. Testing was conducted in normal operating conditions, low ambient conditions, and with a simulated cascade cycle. Temperatures and pressures along the refrigeration piping along with air velocity and temperature at both the inlet and outlet of the fan were taken during each of these tests. The EES model was then modified to more closely simulate the unit with data received from testing. Data from these tests can be viewed in the Results section of the paper.

Normal operating conditions were important to document to compare to the low ambient and cascade cycle conditions. Without understanding how the unit was intended to operate, it was impossible to assess the capabilities of the heat pump with and without the cascade cycle simulation during low ambient testing. The normal operating condition testing was conducted inside the loading dock area of Higgins Laboratory at WPI with a controlled indoor temperature of above 50 °F.

Testing the unit without a cascade cycle simulation in low ambient temperatures was vital to showing both the decrease in capacity in comparison to normal operating conditions as ambient temperatures dropped and the improvement in comparison to the cascade cycle simulation in low ambient. This testing was done outside the loading dock in varying temperatures below 50°F. Due to low pressure ratios during stage 1 testing, our data consists of points taken from stage 2 only.

The last set of testing consisted of various methods of simulating a load on the evaporator to represent a cascade cycle. Methods included blocking the evaporator, blocking

the condenser and positioning the unit halfway indoors so that the evaporator was under the load of the indoor temperature and the rest of the unit was exposed to low ambient temperatures. Blocking the evaporator and condenser was completed using a 3'x4' particle board and a 2'x2'x.5" piece of wood. While blocking the evaporator, the wood was placed against the outside of the evaporator fins. When blocking the condenser, the wood was placed between the filters and the condenser coil.

During each of these conditions, fan data was taken using the handheld anemometer. Data points were taken across the outlet of the condenser and evaporator fans to calculate the face velocities. This anemometer also took air temperature data.

Section 3.5 Refrigeration Diagram 1: Valve Locations

Figure 54. WSC048H refrigerant circuit

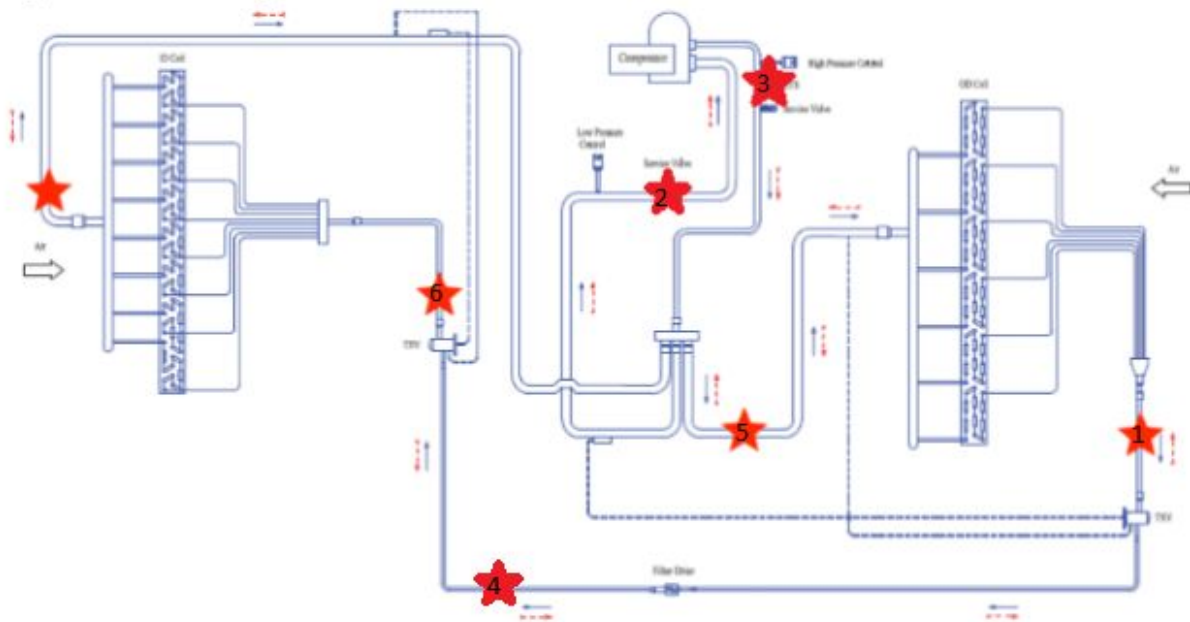

Section 3.6 Refrigeration Diagram 2: Thermocouple locations

Figure 54. WSC048H refrigerant circuit

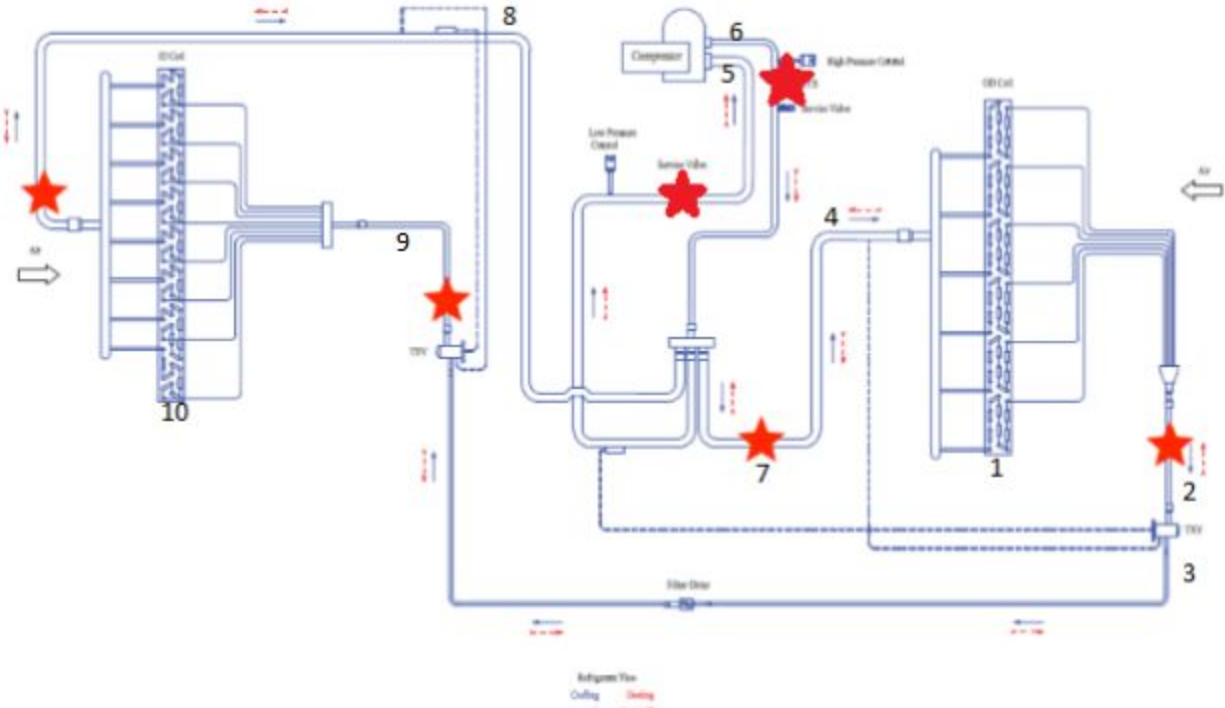

Section 4.0 Results

Section 4.1 Data

	3/14/2019	3/19/2019			4/1/2019	
Testing Condition:	No blockage	No blockage	Block 1/2 of the evaporator	Evaporator Indoors	Condenser 1/4 blocked	Condenser 1/2 blocked
Ambient Temperature (F):	46	38.2	38.2	38.2	33	33
Thermocouple Location						
9 (Condenser Outlet)	68.3	56.5	49.4	54.6	60.3	67.6
4 (Evaporator Outlet)	42.5	30.1	17.7	35.4		
2 (Evaporator Inlet)	40.4	30.8	18	30.6	30.5	34.3
5 (Suction/Inlet)	40.8	29.8	15	36.5	26.4	34.3
6 (Discharge/outlet)	125.9	89.7	86.5	98.9	99.1	124
10 (Condenser Halfway Point)	74					
8					60.2	63.8
1					43.4	53.1
10					53.9	63.6
7					30	33.7
3					33	29.6
outlet	73.5	57.2				
Pressure Gauges (psi)						

1 (evap inlet)	245	105	85	105	100	110
2 (Suction inlet)	95	75	70	85	80	90
3 (discharge)	120	190	175	195	200	290
4 (liquid line)	245	180	175	195	200	285
5 (Ent. rev. valve)	95	75	65	80	75	85
6 (Leaving cond)	235	190	180	205	205	300

Section 4.2 Trends in Data

Under the operating conditions, a variety of observations were made regarding the differences in performance with the tests. Many tests were created throughout the process of completing the project to experiment with simulated loads, outdoor conditions, and fan data. These test processes are explained in the methodology section and are as follows: normal operating conditions, low ambient conditions, normal operating conditions with evaporator blockage, normal operating conditions with condenser blockage, low ambient conditions with evaporator blockage, low ambient conditions with condenser blockage, and low ambient with simulated load from conditioned space.

There were various tests performed to determine which type of testing yielded useful data. The first was testing under normal operating conditions without any blockage of the condenser or evaporator. This data solidified the 45/130/15 operating conditions we expected.

The second operating condition that provided useful data was under low ambient temperature. While under low ambient temperatures, pressures and temperatures at each point were operating at the lowest range in the test data. These lower values indicate that the refrigeration cycle is less effective in heating capacity. .

The next test performed was simulating a load on the evaporator under low ambient temperatures. Useful data was retrieved with part of the condenser blocked off. Testing with the unit half indoors showed that increasing the load on the evaporator would increase the heat output of the condenser, which affirmed that a cascade cycle that could create this load on the evaporator would do the same. However, this testing more closely represented the evaporator in higher ambient temperatures rather than in low ambient with a cascade cycle.

When testing with the evaporator blocked off, we were decreasing the area to absorb heat from the ambient air, thus decreasing temperatures across the coils, pressure, pressure ratio, and efficiency. This gave a useful conclusion that blocking the evaporator was not helpful in our project. However, blocking the condenser increased temperatures and pressures, and decreased the area of heat rejection. The supply air temperature also increased, giving proof that the heat output had increased. Due to the decrease in area of heat rejection, however, the efficiency was decreased in comparison to normal operating conditions.

Each test simulated a situation whether a standard operating condition under the given temperature or an operating condition involving a load and simulating the effect of a cascade cycle. The pressure and temperature data collected during these tests helped to gauge the overall performance of the pump.

During each of these tests, air velocity data was taken. This data did not vary with normal operating conditions or low ambient conditions, as we assume constant density of air. The air velocity and area measurements allowed us to calculate the face velocity, thus the CFM and Q_{out} .

Section 4.3 EES Code Model

The EES code was able to utilize inputs from Trane and test data. Below are the results.

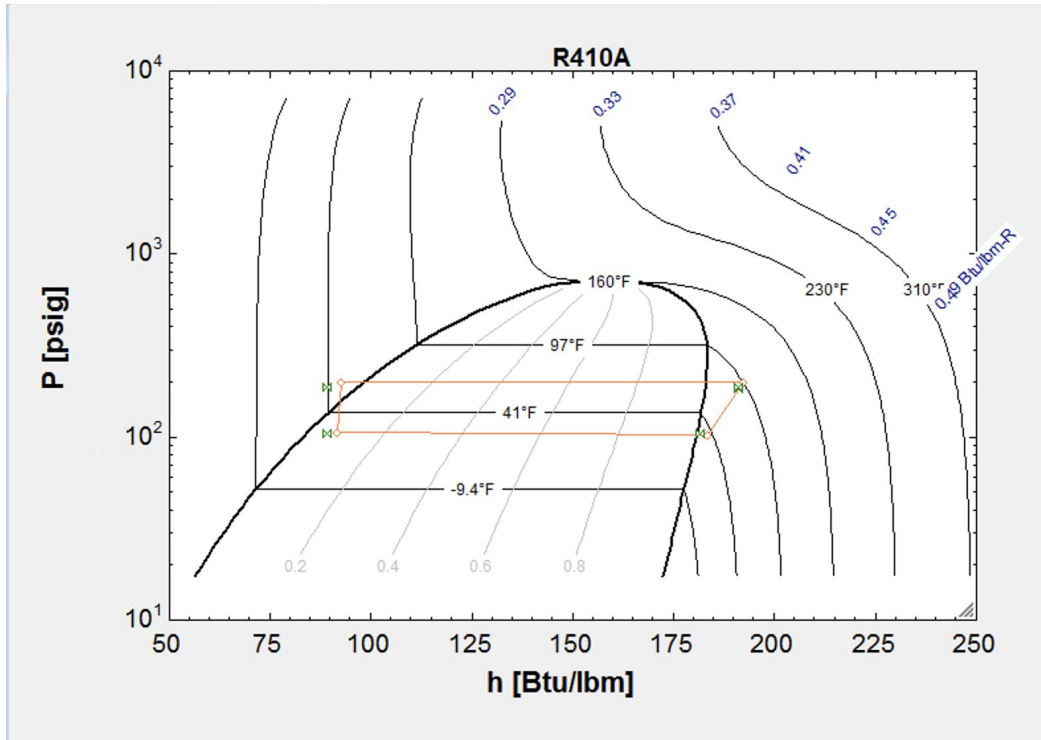

Figure 15: Pressure Enthalpy Diagram from EES
(Orange: Trane Data Green: EES Model)

Table 2 Refined Table										
1.1	COP	CW	$W_{in,compressor,r}$	$W_{in,electrical}$	$m_{compressor}$	$T_{air,in}$	$T_{air,out}$	T1	P1	h1
	[-]	[Btu/hr]	[W]	[Btu/hr]	[lbm/hr]	[F]	[F]	[F]	[psig]	[Btu/lbm]
Run 1	10.84	3808	2022	6901	405	38.2		29.8	105	181.6

11	T2	P2	h2	T3	P3	h3	T4	P4	h4	NTQ
	[F]	[psig]	[Btu/lbm]	[F]	[psig]	[Btu/lbm]	[F]	[psig]	[Btu/lbm]	[Btu/hr]
	89.7	187.8	191	40.42	187.8	89.06	26.39	105	89.06	37481

Figure 16: Run 1 Data from EES

Table 2: Data from Trane and EES

Variables	Trane	MQP Team	Difference
P1 [psig]	103.6	105	-1.4

H1 [Btu/lbm]	183.5	181.6	1.9
P2 [psig]	200.5	187.8	12.7
H2 [Btu/lbm]	192.3	191	1.3
P3 [psig]	198.8	187.8	11
H3 [Btu/lbm]	92.68	89.06	3.62
P4 [psig]	107.1	105	2.1
H4 [Btu/lbm]	91.76	89.06	2.7
Q Condenser [Btu/hr]	37488.33	35920	1568.33
Q Evaporator [Btu/hr]	34207.08	32447	1760.08
W Compressor [Btu/hr]	3281.25	3473	-191.75

Section 5.0 Conclusion and Recommendations

In conclusion, our hypothesis that an applied load to the evaporator is an effective way to increase the overall performance of the heat pump unit was proven to be correct. The data produced by the EES model is closely aligned with the data collected from the experimental testing done on the unit. The cascade cycle was simulated in physical testing of the unit by blocking off portions of the condenser in order to replicate the effects of a load on the system. Due to delays and complications with the delivery of the unit as well as trouble with modeling in the EES software, a fully functioning cascade cycle was not modeled in the program. From the test results, we can infer that the addition of a cascade cycle would help to increase the efficiency due to the rise in pressures and temperatures across the system when a load was placed on the device. The actual cascade cycle would be specified to provide the amount of heat that was added as a load to the system through a heat exchanger across the evaporator. Various refrigerants would need to be tested to provide the more heat at lower ambient

temperatures, so a suitable refrigerant would require a boiling point much lower than that of R-410A.

If this project were continued, we recommend further research on the cascade cycle for this system. This project could be expanded upon by adding a second refrigeration cycle and an assumed efficiency of heat transfer to the EES code. Utilizing EES, the area, mass flow rate, and heat rejection of the cascade cycle could be determined. To run a cascade cycle an additional compressor would be necessary, thus new compressor models would be needed. After using EES, it would be beneficial to design the physical cascade cycle for the unit.

We also recommend taking caution in trying to complicate the model early and to be weary about which compressor model is used to calculate mass flow. Mass flow rate was the most difficult aspect of the project to determine, since there was not a direct way of measuring it within the unit. Mass flow rate directly affects the amount of heat that is transferred throughout the system, so accuracy is important. For future projects, we recommend the project group determines an effective method to measure this value physically if possible.

Some of the other values that gave us trouble in the EES model was the calculated enthalpies for state points 3 and 4. In theory, the enthalpy of state 3 and the enthalpy of state 4 should be equal, however when calculating each enthalpy based on the amount of heat transferred between the air and the refrigerant the numbers were not close in value. For this reason, we recommend future projects to assume isenthalpic expansion as it aligns with experimental verification and is an industry accepted assumption.

Another part of the project that should be considered is assuring all gauges and thermocouples are properly calibrated and installed before they are arranged in the unit. False reading and measurements cause a variety of errors in both the acquired data and the code. A couple of pressure gauges were giving us low pressure readings, and it was verified that the gauges were functioning properly, but the connection was likely not entirely perpendicular to the refrigerant flow. If the gauge connection was tilting against the refrigerant flow, the gauge would read lower pressures, which explains some of our experimental results of the suction pressure, in particular.

Section 6.0 Appendices

6.1 3/19/2019 Test Data

1: Outdoors No Blocking of Evaporator (Amb=38.2F)				Test 2-Test 1			
Location	Temperature	Location	Pressure (psi)	Location	Temperature	Location	Pressure (psi)
9 (Condenser Outlet)	56.5	1 (evap inlet)	105	9 (Condenser Outlet)	-7.1	1	-20
4 (Evaporator Outlet)	30.1	2 (Suction inlet)	75	4 (Evaporator Outlet)	-12.4	2	-5
2 (Evaporator Inlet)	30.8	3 (discharge)	190	2 (Evaporator Inlet)	-12.8	3	-15
5 (Suction/Inlet)	29.8	4 (liquid line)	180	5 (Suction/Inlet)	-14.8	4	-5
6 (Discharge/outlet)	89.7	5 (Ent. rev. valve)	75	6 (Discharge/outlet)	-3.2	5	-10
Outlet Air	57.2	6 (Leaving cond)	190	Outlet Air		6	-10
2: Outdoors Blocking 1/2 of Evaporator (Amb=38.2F)				Test 3-Test 1			
Location	Temp	Location	Pressure (psi)	Location	Temp	Location	Pressure (psi)
9 (Condenser Outlet)	49.4	1 (evap inlet)	85	9 (Condenser Outlet)	-1.9	1	0
4 (Evaporator Outlet)	17.7	2 (Suction inlet)	70	4 (Evaporator Outlet)	5.3	2	10
2 (Evaporator Inlet)	18	3 (discharge)	175	2 (Evaporator Inlet)	-0.2	3	5
5 (Suction/Inlet)	15	4 (liquid line)	175	5 (Suction/Inlet)	6.7	4	15
6 (Discharge/outlet)	86.5	5 (Ent. rev. valve)	65	6 (Discharge/outlet)	9.2	5	5
Outlet Air		6 (Leaving cond)	180	Outlet Air		6	15

3: Condenser Outdoors, Evaporator Indoors (Amb=38.2F)				Test 3-Test 2			
Location	Temperature	Location	Pressure (psi)	Location	Temperature	Location	Pressure (psi)
9 (Condenser Outlet)	54.6	1 (evap inlet)	105	9 (Condenser Outlet)	5.2	1	20
4 (Evaporator Outlet)	35.4	2 (Suction inlet)	85	4 (Evaporator Outlet)	17.7	2	15
2 (Evaporator Inlet)	30.6	3 (discharge)	195	2 (Evaporator Inlet)	12.6	3	20
5 (Suction/Inlet)	36.5	4 (liquid line)	195	5 (Suction/Inlet)	21.5	4	20
6 (Discharge/outlet)	98.9	5 (Ent. rev. valve)	80	6 (Discharge/outlet)	12.4	5	15
Outlet Air		6 (Leaving cond)	205	Outlet Air		6	25

6.2 4/1/2019 Test Data

2: Outdoors Blocking smaller sized board (Amb=33F)			
Location Thermocouple	Temperature	Location Pressure Taps	Pressure (psi)
9 (Condenser Outlet)	60.3	1 (evap inlet)	100
4 (Evaporator Outlet)		2 (Suction inlet)	80
2 (Evaporator Inlet)	30.5	3 (discharge)	200
5 (Suction/Inlet)	26.4	4 (liquid line)	200
6 (Discharge/outlet)	99.1	5 (Ent. rev. valve)	75
Outlet Air		6 (Leaving cond)	205
8	60.2		
1	43.4		
10	53.9		
7	30		
3	33		
2: Outdoors Blocking cond w particle (Amb=33F)			

2: Outdoors Blocking cond w particle (Amb=33F)			
Location	Temperature	Location	Pressure (psi)
9 (Condenser Outlet)	67.6	1 (evap inlet)	110
4 (Evaporator Outlet)		2 (Suction inlet)	90
2 (Evaporator Inlet)	34.3	3 (discharge)	290
5 (Suction/Inlet)	34.3	4 (liquid line)	285
6 (Discharge/outlet)	124	5 (Ent. rev. valve)	85
Outlet Air		6 (Leaving cond)	300
8	63.8		
1	53.1		
10	63.6		
7	33.7		
3	29.6		

6.3 Master Test Data

	3/14/2019	3/19/2019			4/1/2019	
Testing Condition:	No blockage	No blockage	Block 1/2 of the evaporator	Evaporator Indoors	Condenser 1/4 blocked	Condenser 1/2 blocked
Ambient Temperature (F):	46	38.2	38.2	38.2	33	33
Thermocouple Location						
9 (Condenser Outlet)	68.3	56.5	49.4	54.6	60.3	67.6

4 (Evaporator Outlet)	42.5	30.1	17.7	35.4		
2 (Evaporator Inlet)	40.4	30.8	18	30.6	30.5	34.3
5 (Suction/Inlet)	40.8	29.8	15	36.5	26.4	34.3
6 (Discharge/outlet)	125.9	89.7	86.5	98.9	99.1	124
10 (Condenser Halfway Point)	74					
8					60.2	63.8
1					43.4	53.1
10					53.9	63.6
7					30	33.7
3					33	29.6
outlet	73.5	57.2				
Pressure Gauges (psi)						
1 (evap inlet)	245	105	85	105	100	110
2 (Suction inlet)	95	75	70	85	80	90
3 (discharge)	120	190	175	195	200	290
4 (liquid line)	245	180	175	195	200	285
5 (Ent. rev. valve)	95	75	65	80	75	85
6 (Leaving cond)	235	190	180	205	205	300

6.4 Unit Nameplate

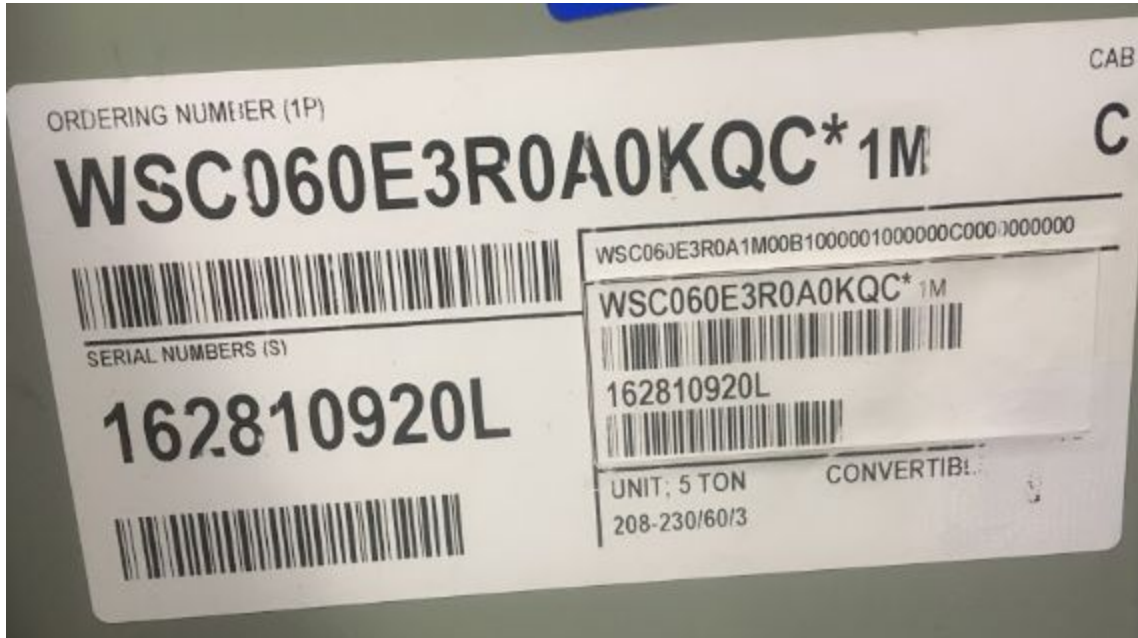

6.5 Unit Set Up







Section 6.6 Fans Speeds (fpm)

Evaporator (Front)			Average:						
535	500	150	406.3333						
343	554	270							
375	450	480		Condensor				Average:	
				516	198		340	177	228.5625
Evaporator (Side)			Average:	278	180		185	150	
287	481	369.6667							
205	439			340	170		177	165	
318	488			238	151		202	190	

Section 6.7 EES Code

```

"state 3"
h3=h4                                     "Assuming Industry Standard Isenthalpic Expansion, Heat across the evaporator was more accurate"
s3=entropy(R410A,P=P3,h=h3)
T3= temperature(R410A, P=P3, h=h3)

h3a=enthalpy(R410A, P=245 [psig] , T=68 [F])

"state 4"
P4=P1
s4=entropy(R410A, P=P4, h=h4)
T4=temperature(R410A, P=P4, h=h4)
h4= [h3] h1-(NTQ/m_dot_compressor)

"Q across Evaporator"
V_evap_a= 315 [ft/min]                    "Face Velocity of the Evaporator"
V_evap= V_evap_a*convert(ft/min, ft/hr)   "Face velocity feet per hour"
A_evap= 17 [ft^2]                         "Face Area of the Evaporator"
TSE= temperature(R410A, P=P4, x=0.3)      "Saturation Temperature of the Evaporator...Assuming quality of .5"

K=(K_1)+(K_2*V_evap)-(K_3*(V_evap)^2)+(K_4*T_air_in)-(K_5*(T_air_in)^2)+(K_6*V_evap*T_air_in)  "Linear Regression from EES, R^2=100%"
K_1= lookup("K_const", 1, 'K_1')
K_2= lookup("K_const", 1, 'K_2')
K_3= lookup("K_const", 1, 'K_3')
K_4= lookup("K_const", 1, 'K_4')
K_5= lookup("K_const", 1, 'K_5')
K_6= lookup("K_const", 1, 'K_6')

LMTD1=LM_1-LM_2*V_evap-LM_3*V_evap^2+LM_4*TSE-LM_5*TSE^2+LM_6*V_evap*TSE  "Linear Regression from EES, R^2= 100%"
LM_1= lookup("LMTD", 1, 'LM_1')
LM_2= lookup("LMTD", 1, 'LM_2')
LM_3= lookup("LMTD", 1, 'LM_3')
LM_4= lookup("LMTD", 1, 'LM_4')
LM_5= lookup("LMTD", 1, 'LM_5')
LM_6= lookup("LMTD", 1, 'LM_6')

NTQ= A_evap*K*LMTD1                      "Net Total Heat gained by the refrigerant"

"Calculations"
COP=(h2-h3)/(h2-h1)
CPh heating=T2/(T2-T4)
W_in_electrical=W_in_compressor_model*convert(W, Btu/hr)  "Converting work in to BTU/hr"
CW=m_dot_compressor*(h2-h1)  "Compressor Work done on the fluid"
n_compressor= CW/W_in_electrical  "Compressor Efficiency"
n_isentropic=(h2s-h1)/(h2-h1)  "solve for isentropic efficiency along with unit measurements to model the cascade cycle compressor"

"Actual T-s Values from Experiments"
s1a=entropy(R410A, T=29.8 [F], P=75 [psig])
s2a=entropy(R410A, T=89.7 [F], P=190 [psig])
s3a=entropy(R410A, T=66.5 [F], P=190 [psig])
s4a=entropy(R410A, x=.3 , P=120 [psig])
h4a=enthalpy(R410A, T=30.8 [F], P=125 [psig])

T1a= 29.8 [F]
T2a= 89.7 [F]
T3a= 66.5 [F]
T4a= 30.8 [F]

```

"Model of Trane 5 ton Air Source Heat Pump"

"Input Values"

"T1, T2, P2, and T_air_in are all varied in parametric table 2"

P1= 105 [psig] "Pressure before compressor"

P3=P2 "isobaric condensing"

"Defining the remaining properties"

"state 1"

s1=entropy(R410A,T=T1, P=P1)

h1=enthalpy(R410A,T=T1, P=P1)

"Compression"

"Temperatures for Compressor Models"

tD= temperature(R410A, x=1, P=P2) "Discharge Temperature - Temperature right before the condensor"

tS = T1-11 { temperature(R410A, x=1, P=P1)} "Suction Temperature - Temperature right after the evaporator"

stage=2 "Stage 1 or 2 of the Compressor"

"Mass Flow Rate based on Compressor Model and ASHRAE Polynomial Equation"

m_dot_compressor= 405 [lbm/hr] "Determined from iterative solution. ASHREA version shown as original equation for solving for mass flow rate"

```

Q Across Condenser"
enthalpic expansion|*****
*****This information was used primarily as reference, since heat across the evaporator was found to be more accurate to determine h3 while assuming

/_cond= 164 [ft/min] "Face Velocity of air passing through the Condenser"
/_cond_1=V_cond*convert(ft/min, ft/hr) "Converting to ft/hr for Condenser Characteristic Equation"
\_tot=9.1395 [ft^2] "Face Area of the Condenser"
\_vtp= A_tot*.875 "Percent of area responsible for bringing superheated vapor to saturated liquid...From Trane Condenser Curves"
\_sc= A_tot*.125 "Percent of area responsible for subcooling...From Trane Condenser Curves"
TSC= temperature(R410A, P=P2, x=.5) "Saturation Temperature of the Condenser...Assuming quality of .5"

COND_Char= (CC_1*_cond_1^2)+CC_2*_cond_1+CC_3 "Condenser Characteristic from Trane Condenser Curves"
CC_1=lookup(COND_Char, 1, 'CC_1') "Constants from Polynomial Trendline of TRANE Experimental Data"

```

```

(( C1 +C2*(tS)+C3*tD+C4*(tS^2)+C5*(tS*tD)+C6*(tD^2)+C7*(tS^3)+C8*(tD*tS^2)+C9*(tS*tD^2)+C10*(tD^3) )

```

```

C1=lookup(Compressor_Model_MDOT, 2, 'C1)
C2=lookup(Compressor_Model_MDOT, 2, 'C2)
C3=lookup(Compressor_Model_MDOT, 2, 'C3)
C4=lookup(Compressor_Model_MDOT, 2, 'C4)
C5=lookup(Compressor_Model_MDOT, 2, 'C5)
C6=lookup(Compressor_Model_MDOT, 2, 'C6)
C7=lookup(Compressor_Model_MDOT, 2, 'C7)
C8=lookup(Compressor_Model_MDOT, 2, 'C8)
C9=lookup(Compressor_Model_MDOT, 2, 'C9)
C10=lookup(Compressor_Model_MDOT, 2, 'C10)
}

```

"Compressor Work In based on Compressor Model and ASHRAE Polynomial Equation"

```

Win_compressor_model= W1 +W2*(tS)+W3*tD+W4*(tS^2)+W5*(tS*tD)+W6*(tD^2)+W7*(tS^3)+W8*(tD*tS^2)+W9*(tS*tD^2)+W10*(tD^3)

```

```

W1=lookup(Compressor_Model_WORK, 2, 'W1)
W2=lookup(Compressor_Model_WORK, 2, 'W2)
W3=lookup(Compressor_Model_WORK, 2, 'W3)
W4=lookup(Compressor_Model_WORK, 2, 'W4)
W5=lookup(Compressor_Model_WORK, 2, 'W5)
W6=lookup(Compressor_Model_WORK, 2, 'W6)
W7=lookup(Compressor_Model_WORK, 2, 'W7)
W8=lookup(Compressor_Model_WORK, 2, 'W8)
W9=lookup(Compressor_Model_WORK, 2, 'W9)
W10=lookup(Compressor_Model_WORK, 2, 'W10)

```

"state 2"

```

s2= entropy(R410A, h=h2, T=T2)

```

```

h2s=enthalpy(R410A, s=s1, P=P2)

```

"Isentropic compression h2"

```

h2= enthalpy(R410A, T=T2, P=P2)

```

"Actual h2"

```

P2_1=lookup(P2_Constants, 1, 'P2_1)

```

"Constants from Polynomial Trendline of Experimental Data"

```

P2_2=lookup(P2_Constants, 1, 'P2_2)

```

```

P2_3=lookup(P2_Constants, 1, 'P2_3)

```

```

P2= P2_1*T2^2+P2_2*T2-P2_3

```

"P2 from Polynomial Trendline of Experimental Data"

Section 7.0 References

Air-source heat pump (2017). (1st ed.) Oxford University Press. Retrieved from

<http://www.oxfordreference.com/view/10.1093/acref/9780191826276.001.0001/acref-9780191826276-e-1>

9

Bertsch, S. S., Groll, E. A., & Garimella, S. V. (2009). A composite heat transfer correlation for saturated flow boiling in small channels. *International Journal of Heat and Mass Transfer*, 52(7-8), 2110-2118.

Brown, M., Burke-Scoll, M., & Stebnicki, J. (2011). *Air source heat pump efficiency gains from low ambient temperature operation using supplemental electric heating*. Franklin Energy.

Chua, K. J., Chou, S. K., & Yang, W. M. (2010). Advances in heat pump systems: A review. *Applied Energy*, 87(12), 3611-3624. doi:10.1016/j.apenergy.2010.06.014

De Kleijn Energy Consultants. "Industrial Heat Pumps." Refrigerants / Industrial Heat Pumps, 2019, industrialheatpumps.nl/en/how_it_works/refrigerants/.

Figuerola-Gerstenmaier, S., Francova, M., Kowalski, M., Lisal, M., Nezbeda, I., & Smith, W. R. (2007). Molecular-level computer simulation of a vapor-compression refrigeration cycle. *Fluid Phase Equilibria*, 259(2), 195-200.

Guoyuan, M., Qinhu, C., & Yi, J. (2003). *Experimental investigation of air-source heat pump for cold regions* doi://doi.org/10.1016/S0140-7007(02)00083-X

Heat pump buying guide. Retrieved from

<https://www.consumerreports.org/cro/heat-pumps/buying-guide>

Heating and cooling mechanics terminology. (2016). Retrieved from

<https://www.rfohl.com/heating-cooling-mechanics-terminology/>

Hepbasli, A., & Kalinci, Y. (2009). *A review of heat pump water heating systems*

doi://doi.org/10.1016/j.rser.2008.08.002

Jin, L., Yin, X., Pan, S., Yang, D., & Cao, F. (2016). *Performance comparison of air-source heat pumps using economizer vapor injection and internal heat exchanger in cold regions* Purdue University. Retrieved from

https://www.openaire.eu/search/publication?articleId=od_540::66063f96667e8ddaf0bd2de89adc1ad6

Kharagpur. (2008). *Refrigeration and air conditioning*. India: Retrieved from

https://www.academia.edu/7373920/Refrigeration-and-Air-Conditioning_2

Kim, J., Lee, J., Choi, H., Lee, S., Oh, S., & Park, W. (2015). Experimental study of R134a/R410A cascade cycle for variable refrigerant flow heat pump systems. *Journal of Mechanical Science and Technology*, 29(12), 5447-5458. doi:10.1007/s12206-015-1146-2

Learn about air-source heat pumps. (2015). Retrieved from www.masscec.com

Lin, S. (1999). *Modern Thermodynamics: From Heat Engines to Dissipative Structures.*,

Liu, X., & Hong, T. (2010b). *Comparison of energy efficiency between variable refrigerant flow systems and ground source heat pump systems* doi://doi.org/10.1016/j.enbuild.2009.10.028

Macmichael, D. B. A. (2013). *Heat pumps* Elsevier.

mechanicaltutorial.4 stages of carnot cycle improving thermal efficiency.

Mini-split heat pumps: The advantages & disadvantages. (2015). Retrieved from

<https://learn.compactappliance.com/mini-split-heat-pumps/>

Mustafa Omer, A. (2008). *Ground-source heat pumps systems and applications*

doi://doi.org/10.1016/j.rser.2006.10.003

Qu, M., Fan, Y., Chen, J., Li, T., Li, Z., & Li, H. (2017). Experimental study of a control strategy for a cascade air source heat pump water heater. *Applied Thermal Engineering*, 110, 835-843.

doi:10.1016/j.applthermaleng.2016.08.176

R.K. Johnson. (2013). *Measured performance of a low temperature air source heat pump*. (). United States: USDOE Office of Energy Efficiency and Renewable Energy (EERE), Building Technologies Office (EE-5B) (Building America). Retrieved from

<http://www.osti.gov/scitech/biblio/1220259>

Rooftop units | precedent 3 to 10 tons | trane commercial. Retrieved from

<http://commercial.trane.com/content/trane-commercial/north-america/us/en/products-systems/equipment/unitary/rooftop-systems/Precedent/precedent-3-to-10-tons.html>

Rotary compressors and Types|Working Principle|Engineering explained. (2015, March). Retrieved

from <http://aermech.com/rotary-compressors-and-typesworking-principleengineering-explained/>

Tarrad, A. H. (2017). Thermodynamic evaluation for intermediate temperature optimization in low temperature heat source cascade heat pump technology. *Int.J. Environ. Sci. (Accepted)*

US EPA, O. (2016). Revised section 608 refrigerant management regulations. Retrieved from

<https://www.epa.gov/section608/revised-section-608-refrigerant-management-regulations>

Wiley, J. (2017). *Fundamentals of thermodynamics* (9th ed.)