

**THE IMPACT OF UNIVERSAL SERVICE OBLIGATIONS AND OTHER  
EXTERNAL AND CROSS SUBSIDIES ON TELEDENSITY IN DEVELOPING  
COUNTRIES**

by

Boris Ramos

A Dissertation

Submitted to the Faculty

of the

WORCESTER POLYTECHNIC INSTITUTE

in partial fulfillment of the requirements for the

Degree of Doctor of Philosophy

in

Telecom Planning and System Dynamics

May 2006

APPROVED:

Dr. Khalid Saeed, Chairman of the Doctoral Committee

Dr. Kaveh Pahlavan, Co-chair of the Doctoral Committee

Dr. Kevin Clements, Member of the Doctoral Committee

Dr. Arthur Gerstenfeld, Member of the Doctoral Committee

Dr. Oleg Pavlov, Member of the Doctoral Committee

**To My Wife and My Daughter**

## **ABSTRACT**

The failure to consider the complexity of the regional telecommunication systems in planning has increased the telecom gap between other regions and the rural sectors in the developing countries. Earmarked funds generated by Universal Service Obligations and various types of other direct and cross-subsidies have not helped this situation. This research uses system dynamics modeling approach to understand the complexity of the system and to evaluate how different policies affect telephone densities. It is demonstrated that some of the prevalent policies may be counterproductive. Policy experiments with the model demonstrate that market-clearing pricing implemented with Universal Service Obligations, and a value-added service combination may significantly improve rural telecommunications.

## **PREFACE**

The poor people that live in rural areas of developing countries lack of the opportunities and benefits that people from cities and metropolis have. This dissertation is intended to improve the access of the rural population to telephone services, which are considered essential for economic development. This research was developed to shed light on the issue of external and cross subsidies in telecommunications in developing countries and to develop policies that have a synergic and positive impact on telephone dispersion.

## **ACKNOWLEDGEMENTS**

This research could not have been developed without the contributions of many persons and institutions:

I am deeply grateful to my advisor Professor Khalid Saeed. His teaching about system dynamics, economics, and research gave me the knowledge and ideas to structure and define this investigation. His guidance through the whole dissertation process and words of wisdom and support helped me to finish this dissertation. It was an honor to work with him.

Thanks are due to Professor Kaveh Pahlavan for recommending me this program and for his invaluable advice, friendship, and support through the whole program.

I am also very thankful to Professor Arthur Gerstenfeld. His advice, friendship, words of motivation, and continuous support helped me to finish this program. His contribution to this program was also invaluable.

I am also thankful to Professor Oleg Pavlov for his time and patience in reading my dissertation, to Prof. James Lyneis for his support and for teaching me System Dynamics, and to Prof. Kevin Clements for his valuable comments as my Thesis committee member. Thanks also to Prof. Sharon Johnson for her continuous support and guidance, and to Prof. Radzicki for his words of support.

I am also thankful to many friends for their help in the last few years. Mohamed Aboulezz, Ricardo Aguirre, Martin Simon, Bardia Alavi, Carsten Paulsen, Victor Gonzales, Francisco Alayo, David Rose, and Zahed Sheikholeslami.

Special thanks to Nelson Cevallos from Fundación Capacitar, the Organization of American States, and ESPOL for their support.

## CONTENT

<b>CHAPTER 1 INTRODUCTION.....</b>	<b>15</b>
<b>1.1 OBJECTIVE OF THIS DISSERTATION .....</b>	<b>15</b>
<b>1.2 REGIONAL TELECOMMUNICATIONS IN DEVELOPING COUNTRIES..</b>	<b>15</b>
<b>1.3 POLICIES FOR IMPROVING TELEPHONE DISPERSION IN DEVELOPING COUNTRIES.....</b>	<b>16</b>
<b>1.4 TELECOM TECHNOLOGIES AND SERVICES FOR IMPROVING THE TELEPHONE DISPERSION IN DEVELOPING COUNTRIES .....</b>	<b>18</b>
<b>1.5 SYSTEM DYNAMICS MODELING OF REGIONAL TELECOMMUNICATIONS IN DEVELOPING COUNTRIES.....</b>	<b>20</b>
<b>1.6 SUMMARY FINDINGS OF THE RESEARCH.....</b>	<b>22</b>
<b>CHAPTER 2 PROBLEM BACKGROUND.....</b>	<b>24</b>
<b>2.1 THE TELEPHONE DISPERSION PROBLEM IN DEVELOPING COUNTRIES .....</b>	<b>24</b>
<b>2.2 REGIONAL TELEPHONE GAP IN DEVELOPING COUNTRIES.....</b>	<b>29</b>
<b>2.3 UNSUCCESSFUL TELECOMMUNICATIONS POLICIES IN DEVELOPING COUNTRIES .....</b>	<b>32</b>
<b>2.4.1 INTERNATIONAL CROSS-SUBSIDIES.....</b>	<b>36</b>
<b>2.4.2 UNIVERSAL SERVICE OBLIGATIONS .....</b>	<b>41</b>
<b>2.5 PERFORMANCE OF UNIVERSAL SERVICE OBLIGATIONS AND INTERNATIONAL CROSS-SUBSIDIES IN DEVELOPING COUNTRIES.....</b>	<b>47</b>
<b>CHAPTER 3 METHODS OF ANALYSIS FOR TELECOM PLANNING AND POLICIES.....</b>	<b>49</b>

<b>3.1 THE FAILURE OF CURRENT METHODS FOR TELECOM PLANNING AND POLICY DESIGN.....</b>	<b>49</b>
<b>3.2 SYSTEM DYNAMICS AS A METHODOLOGY FOR POLICY DESIGN AND PLANNING OF RURAL TELECOMMUNICATIONS. ....</b>	<b>53</b>
<b>CHAPTER 4 FORMULATION OF THE REGIONAL TELECOMMUNICATIONS SYSTEM.....</b>	<b>57</b>
<b>4.1 TELEPHONE DEMAND SECTOR.....</b>	<b>60</b>
<b>4.2 EQUATIONS OF THE TELEPHONE DEMAND SECTOR.....</b>	<b>61</b>
<b>4.3 TELEPHONE DEPLOYMENT SECTOR.....</b>	<b>66</b>
<b>4.4 EQUATIONS OF THE TELEPHONE DEPLOYMENT SECTOR .....</b>	<b>67</b>
<b>4.5 TELEPHONE TRAFFIC SECTOR .....</b>	<b>70</b>
<b>4.6 EQUATIONS OF THE TELEPHONE TRAFFIC SECTOR.....</b>	<b>71</b>
<b>4.7 FINANCIAL RESOURCES SECTOR.....</b>	<b>74</b>
<b>4.8 EQUATIONS OF THE FINANCIAL RESOURCES SECTOR .....</b>	<b>75</b>
<b>4.9 THE REFERENCE MODE OF THE REGIONAL TELECOM SYSTEM .....</b>	<b>79</b>
<b>CHAPTER 5. THE IMPACT OF UNIVERSAL SERVICE OBLIGATIONS AND INTERNATIONAL CROSS-SUBSIDIES ON THE DISPERSION OF TELEPHONE SERVICES IN DEVELOPING COUNTRIES .....</b>	<b>85</b>
<b>5.1 THE IMPACT OF IMPLEMENTING UNIVERSAL SERVICE OBLIGATIONS .....</b>	<b>85</b>
<b>5.2 THE IMPACT OF IMPLEMENTING INTERNATIONAL CROSS-SUBSIDIES .....</b>	<b>88</b>
<b>5.3 POLICIES FOR IMPROVING TELEPHONE PENETRATION. ....</b>	<b>93</b>

<b>5.3.1 MARKET-CLEARING PRICING .....</b>	<b>93</b>
<b>5.3.2 MARKET-CLEARING PRICING WITH UNIVERSAL SERVICE OBLIGATION.....</b>	<b>95</b>
<b>5.3.3 FORMULATION OF MARKET-CLEARING PRICING.....</b>	<b>99</b>
<b>5.3.4 SENSITIVITY OF POLICIES FOR IMPROVING RURAL TELECOMMUNICATIONS.....</b>	<b>100</b>
<b>5.3.5 CONCLUSIONS.....</b>	<b>102</b>
<b>CHAPTER 6. A VALUE ADDED SERVICE STRATEGY FOR THE IMPROVEMENT OF TELEPHONE DENSITY IN RURAL AREAS OF DEVELOPING COUNTRIES.....</b>	<b>105</b>
<b>6. 1 ABSTRACT.....</b>	<b>105</b>
<b>6.2 INTRODUCTION.....</b>	<b>105</b>
<b>6.3 VALUE ADDED SERVICES IN TELECOMMUNICATIONS .....</b>	<b>107</b>
<b>6.4 IMPACT OF VALUE ADDED SERVICES ON TELEPHONE EXPANSION .....</b>	<b>110</b>
<b>6.4.1 PAYPHONE SERVICE.....</b>	<b>111</b>
<b>6.4.2 VIRTUAL TELEPHONY SERVICE .....</b>	<b>113</b>
<b>6.4.3 VIRTUAL TELEPHONY AND PAYPHONE SERVICES .....</b>	<b>116</b>
<b>6.4.4 PREPAID PHONE SERVICE .....</b>	<b>118</b>
<b>6.4.5 EQUATIONS OF VALUE ADDED SERVICES .....</b>	<b>122</b>
<b>6.5 A VALUE ADDED SERVICE STRATEGY FOR IMPROVING REGIONAL TELECOMMUNICATIONS.....</b>	<b>131</b>



<b>6.6 BASE CASE VALUES .....</b>	<b>136</b>
<b>6.7 SENSITIVITY ANALYSIS OF VALUE ADDED SERVICE STRATEGY... ..</b>	<b>138</b>
<b>6.8 CONCLUSIONS.....</b>	<b>141</b>
<b>CHAPTER 7. AN ANALYSIS OF WIRELESS TECHNOLOGIES ON THE REGIONAL DISPERSION OF TELEPHONE SERVICES IN DEVELOPING COUNTRIES. ....</b>	<b>142</b>
<b>7.1 INTRODUCTION.....</b>	<b>142</b>
<b>7.2 IMPACT OF ACCESS TECHNOLOGIES ON TELEPHONE EXPANSION .....</b>	<b>143</b>
<b>7.3 ACCESS TECHNOLOGIES FORMULATION .....</b>	<b>148</b>
<b>7.3.1 EQUATIONS OF WIRED ACCESS NETWORK.....</b>	<b>148</b>
<b>7.3.2 EQUATIONS OF WIRELESS ACCESS NETWORKS.....</b>	<b>151</b>
<b>7.4 TELEPHONE DISPERSION FOR DIFFERENT ACCESS NETWORKS. .</b>	<b>155</b>
<b>7.5 BASE CASE VALUES .....</b>	<b>164</b>
<b>7.6 SENSITIVITY ANALYSIS OF DIFFERENT ACCESS TECHNOLOGIES</b>	<b>166</b>
<b>7.7 CONCLUSIONS.....</b>	<b>169</b>
<b>CHAPTER 8. RESEARCH CONTRIBUTION AND CONCLUSION.....</b>	<b>170</b>
<b>8.1 PRACTICAL APPLICATIONS .....</b>	<b>170</b>
<b>8.2 COUNTERINTUITIVE POLICIES AND COUNTERPRODUCTIVE TELECOM SYSTEMS.....</b>	<b>171</b>
<b>8.3 NEW POLICIES FOUND.....</b>	<b>172</b>

<b>8.4 VALUE ADDED SERVICE STRATEGY PROPOSED .....</b>	<b>173</b>
<b>8.5 APPLICATION TO THE DISPERSION OF OTHER SERVICES IN DEVELOPING COUNTRIES.....</b>	<b>174</b>
<b>8.6 CONCLUSION .....</b>	<b>175</b>
<b>8.7 FUTURE WORK .....</b>	<b>176</b>
<b>BIBLIOGRAPHY .....</b>	<b>178</b>
<b>APENDIX A: BEHAVIORAL RELATIONSHIPS.....</b>	<b>188</b>
<b>APPENDIX B: MODEL LISTINGS.....</b>	<b>193</b>

## LIST OF FIGURES

<b>Figure 1. Telephones per 100 inhabitants.....</b>	<b>27</b>
<b>Figure 2. Waiting List vs. New Lines in selected Developing Countries.....</b>	<b>28</b>
<b>Figure 3. The Rural-Urban Telephone Density Gap.....</b>	<b>31</b>
<b>Figure 4. A Simplified Sector Map of the Regional Telecom System.....</b>	<b>59</b>
<b>Figure 5. Telephone Demand Sector.....</b>	<b>60</b>
<b>Figure 6. Telephone Deployment Sector.....</b>	<b>66</b>
<b>Figure 7. Telephone Traffic Sector.....</b>	<b>70</b>
<b>Figure 8. Financial Resources Sector.....</b>	<b>74</b>
<b>Figure 9. National Telephone Density of the Reference Mode.....</b>	<b>83</b>
<b>Figure 10. Waiting List vs. New Telephone Lines of the Reference Mode.....</b>	<b>83</b>
<b>Figure 11. Rural-Urban Telephone Density Ratio of the Reference Mode.....</b>	<b>84</b>
<b>Figure 12. Rural Telephone Densities for USO and International Cross-Subsidy Policies.....</b>	<b>91</b>
<b>Figure 13. National Telephone Densities for USO and International Cross-Subsidy Policies.....</b>	<b>91</b>
<b>Figure 14. Causal Structure of Demand and Supply of the Regional Telecom System.....</b>	<b>92</b>
<b>Figure 15. Market and Fixed Monthly Rental Prices.....</b>	<b>97</b>
<b>Figure 16. Feedback Loops affecting Urban Telephone Capacity.....</b>	<b>99</b>
<b>Figure 17. Payphone Service Impact on Telephone Expansion.....</b>	<b>113</b>

<b>Figure 18. Virtual Telephony Service Impact on Telephone Expansion.....</b>	<b>116</b>
<b>Figure 19. Prepaid Phone Service Impact on Telephone Expansion.....</b>	<b>120</b>
<b>Figure 20. Normalized National Teledensity for VAS Implementations.....</b>	<b>135</b>
<b>Figure 21. Normalized Rural Urban Teledensity Gap for VAS Implementations.....</b>	<b>135</b>
<b>Figure 22. Schematic of a Wired Telephone Network.....</b>	<b>144</b>
<b>Figure 23. Schematic of a Telephone Network with Wireless Access Plant.....</b>	<b>145</b>
<b>Figure 24. Causal Structure of Wired Technology in the Regional Telecommunications System.....</b>	<b>147</b>
<b>Figure 25. Causal Structure of Wireless Technologies in the Regional Telecommunications Systems.....</b>	<b>148</b>
<b>Figure 26. Urban Phones for Different Access Networks.....</b>	<b>160</b>
<b>Figure 27. Rural Phones for Different Access Networks.....</b>	<b>160</b>
<b>Figure 28. Urban Cost for Different Access Networks.....</b>	<b>161</b>
<b>Figure 29. Rural Cost for Different Access Networks.....</b>	<b>161</b>
<b>Figure 30. Urban Delay for Different Access Networks.....</b>	<b>162</b>
<b>Figure 31. Rural Delay for Different Access Networks.....</b>	<b>162</b>

## LIST OF TABLES

<b>Table 1. International Cross-Subsidies in selected Developing Market Economies.....</b>	<b>41</b>
<b>Table 2. Indicators of Selected Developing Market Economies with Universal Service Obligations.....</b>	<b>45</b>
<b>Table 3. Universal Service Obligation Policies in selected Developing Market Economies.....</b>	<b>46</b>
<b>Table 4. The Dispersion of Telephones in Selected Developing Market Economies with USO and International Cross-Subsidies.....</b>	<b>48</b>
<b>Table 5. Base Case values used to generate the Reference Mode.....</b>	<b>81</b>
<b>Table 6. Performance of Different Telecom Policies in Developing Countries.....</b>	<b>98</b>
<b>Table 7. Performance of Market-Clearing Pricing Policies for Higher Income per Capita, Implementation Costs and Deployment Times, and Lower Network Externality Impact.....</b>	<b>102</b>
<b>Table 8. The Dispersion of Prepaid Cellular Phones in Selected Developing Market Economies.....</b>	<b>110</b>
<b>Table 9. The Dispersion of Payphones in Selected Developing Market Economies.....</b>	<b>110</b>
<b>Table 10. Impact of Different Value Added Services on Telephone Expansion.....</b>	<b>121</b>
<b>Table 11. Value Added Service Strategy for Improving Rural Telephony</b>	

<b>in Developing Countries with a Cellular Access Network.....</b>	<b>134</b>
<b>Table 12. Base Case values of Value Added Services Analysis.....</b>	<b>138</b>
<b>Table 13. Value Added Service Strategy for Improving Rural Telephony in Developing Countries with a Higher VAS Infrastructure Costs and Payphone Availability Referential, and Lower VAS Easy to Use Factor...</b>	<b>140</b>
<b>Table 14. Performance of Different Access Technologies.....</b>	<b>163</b>
<b>Table 15. Base Case values of the Access Technologies Analysis.....</b>	<b>166</b>
<b>Table 16. Performance of Different Access Technologies for a Thinly Populated Country.....</b>	<b>168</b>

## **Chapter 1 Introduction**

### **1.1 Objective of this Dissertation**

This dissertation has studied the impact of Universal Service Obligations and International Cross-Subsidies on the growth of rural and urban telephone infrastructure in developing countries. This research has also analyzed the impact of wireless and value added services on the regional dispersion of telephone services in developing countries. Computer simulation through System Dynamics modeling is used to evaluate these impacts, and to design new policies. Therefore, as a result of this investigation, new policies and strategies that are able to outperform previous or existing ones have been proposed.

### **1.2 Regional Telecommunications in Developing Countries**

Over the past several decades, telecommunications have often been seen as a luxury in developing countries while investments in basic needs and infrastructure have received much attention (Saunders et. al., 1994). For this reason, developing countries account for forty percent of the total number of telephone lines, although they contain about eighty percent of the world population. In addition, the 'low-income' developing countries have only five percent of the total number of telephone lines worldwide and they contain forty percent of the world population. The situation for rural areas of these low-income countries is even worse. Although more than fifty percent of their population is rural, only 12% of the total number of telephone lines serves these regions (World Telecommunications Indicators Database, 2004). There is, however, a growing recognition that telecommunications is essential for economic development and

political and social integration of remote areas. Linking remote villages to the outside world with telecommunications has been observed to improve the quality of life of the local populations (Hudson, 1984; The ITU-D Focus Group 7, 2000). The realization that telecommunication networks are essential for rural development has called for a search for better policies and investment strategies that should increase telephone penetration in the rural areas.

The deployment of rural telecommunications involves the advancement of the universal service policy. Universal service can be defined as the provision of “universal” availability of connections to public telecommunication networks to individual households, with non-discriminatory and affordable prices (Hank and McCarthy, 2000). An alternative to universal service is “universal access”, which is defined by a situation where every person has a reasonable means of access to a publicly available telephone. In practice, progress toward universal service has been measured by the percentage of households with telephone service (Cain and Macdonald, 1991)

### **1.3 Policies for Improving Telephone Dispersion in Developing Countries**

Several policies have been used by governments and autonomous telecom service organizations in developing countries. These include Universal Service Obligations (USO), which uses resources generated in urban regions to subsidize the deployment of telecom infrastructure in rural regions. The increase of these investment obligations increases the percentage of telecom investment assigned to rural areas.



However, USO decreases the proportion of telecom investment in urban areas. Another common policy is to internally cross-subsidize some services, such as local phone calls, with other services in order to increase the demand and the penetration of telephone lines. This policy has not only been applied to rural areas but also to urban areas, which have been subsidized by the revenue generated from international traffic.

The cross-subsidies in telecommunications have been regarded as a useful mechanism for expanding networks in rural and poor areas of developing countries (Laffont and N’Gbo, 2000), even in the presence of competition (Gasmi et al, 2000). The application of Universal Service Obligations and International Cross-Subsidies is intended to create positive externalities for expansion of services. They translate into network, call, and social externalities, which should improve rural development and the social efficiency and benefit (Crandall and Waverman, 2000; Saunders et al., 1994). The question addressed in this investigation is whether the intended improvement will actually happen in the long term given that there are differences in income per capita, willingness to pay, telephone deployment and operating costs, and telephone deployment delays between urban and rural areas.

There are other important policies in developing countries such as the privatization and liberalization of the telecom markets, which have been implemented in several countries in order to improve telecom services and penetration (Fink et. al., 2002; Strover, 2003). The Universal Service Fund is applied in more liberalized markets and uses resources obtained from several network and service operators to finance capital expenditures on rural network deployment (Siochru, 1996). Finally, the use of

grant based funding is increasing, which subsidizes the deployment of telecom infrastructure using economic resources from the general budget of the country (Kayani and Dymond, 1997).

The current policies for increasing telecommunications deployment in rural areas are considered to be insufficient or unsuccessful, and the plans for expansion of local telephone networks are considered to be imprecise considering the scope of the investment (Malecki, 2003; Melody 1999; Strover, 2003, Calhoun, 1992). For instance, telecom privatization has been related to telephone deployment growth but not to universal service. In addition, previous studies have suggested that privatization of infrastructure delivery would create several problems, since private sector organizations are often not designed to deliver public goods (Saeed and Honggang, 2004). In South Africa, more than 1.5 million new private telephone lines were disconnected, since the private operator did not have the obligation to provide affordable installation, rental, and usage nor to keep the overall number of connections at a specific target (Barendse, 2004).

#### **1.4 Telecom Technologies and Services for Improving the Telephone Dispersion in Developing Countries**

The access plant of the traditional telephone network, as opposed to the switches and backhaul connections, is extremely unproductive and underutilized, and shows fewer economies of scales since it is largely dedicated. The access plant is considered the largest asset of the telephone network, since this can account for more than half of the total assets of the company. The traditional access plant is wired, and is largely a

function of the distance from the subscriber to central office or switching equipment. For this reason, the cost to provide a telephone line to a rural subscriber could be ten times the cost for an urban subscriber (Calhoun, 1992).

Wireless technologies, such as cellular networks and Wireless Local Loop (WLL), are seen as a way to increase telephone density in developing countries, due to its rapid deployment and lower cost (Noerpel, 1997). It has been observed during previous years a rapid growth of cellular networks especially in cities and other urban areas. The wireless technologies are less sensitive to distance than traditional wired technologies, which make them more attractive for deployment in dispersed or scattered rural environments. However, there are still several questions regarding their viability in developing countries. For instance, the lack of electricity and of reliable power supply has been considered the biggest challenge on deploying wireless systems, mainly in the rural areas (Rycroft, 1998). This situation is clearly a problem for African countries, where the access to electricity in the urban areas reaches only fifty percent of their population, and the access in rural areas is just ten percent (Clarke and Wallsten, 2002).

In some cases, the low level of telecom penetration in developing countries has been attributed to an outdated telecommunications system that prevents the implementation of value added services, which are supposedly able to generate more revenue required for telecom investment (Fretes-Cibils et. al., 2003). In some cases, the resources invested in value added services, or intelligent network platform, have been considered to be worthwhile after the revenue of the telecom company is increased, and better service to the subscribers is provided (Hamersma, 1996). However, only few

studies have been developed in order to assess the impact that these innovative solutions have on increasing the connectivity of nations (Barandse, 2004).

### **1.5 System Dynamics Modeling of Regional Telecommunications in Developing Countries.**

System Dynamics is a holistic methodology that deals with the limitation of bounded rationality or linear cause-and-effect relationship commonly applied in policy or strategy design, and considers the main interactions and feedback effects between the different elements of the system. For this reason, System Dynamics is an appropriate simulation methodology for designing and evaluating long-term policies and strategies needed for increasing telephone penetration in rural and urban areas of developing countries.

The need for a systems framework to analyze the complexity of the regional telecommunication system and the importance of focusing more in economic and social aspects rather than the technological ones has been recognized to some degree (Andrew and Petkov, 2003). Telecom planning using a long-term and non-linear system dynamics approach as compared to ‘tactical’ approaches, which are reactive, short-term, and linear, has been advocated (Lyneis, 1994). In addition, new modeling practices, like System Dynamics, has been suggested for the telecommunications industry, which can incorporate the trade-offs raised by the emergence of wireless access alternatives, especially when applied to rural environments (Calhoun, 1992). System Dynamics is used in this dissertation, specifically for investigating the impact of Universal Service

Obligations and International Cross-Subsidies on the growth of rural telecom infrastructure.

This dissertation considers System Dynamics modeling as the best methodology that deals with the complexity and dynamics of the regional telecom system. This has already been successfully applied to design and evaluate long-term policies for telecommunications. It has been used to model the demand and supply of telecommunications (Jensen et. al., 2002), and as a vehicle for integrating different viewpoints of a multidisciplinary team involved in a study of the impact from telecom development in rural Canada (Beal, 1976).

The model developed in this investigation has considered what earlier studies have pointed regarding the value of telephone lines perceived by the population. The value of telephone lines in rural areas is lower than it is in urban areas because of the low-income level, high percentage of primary industry, low level of education, and the way of life of the rural population. For example, the International Telecommunications Union (ITU) has shown that the willingness to pay or demand for telecommunications services is higher in urban areas than it is in rural areas for the same price (GAS 5, 1984), while Saunders, Warford, and Wellenius suggest that income of the population and the level of education influences the demand of telephones as well as the level of telephone traffic. In the same manner, several studies have found that people employed in non-agrarian occupations have more demand for telephone services than people working in primary industries (Saunders et. al., 1994).

## **1.6 Summary Findings of the Research**

It was found that the International Cross-Subsidies addressed by the model, create below cost monthly rental fees by making the international tariffs high and above cost values, are counterproductive as they reduce the overall service penetration due to financial constraints. The International Cross-Subsidy reduces the monthly rental fee to a level lower than the willingness to pay for telephone access and below the operating costs in urban areas, which reduces the financial resources used for telephone supply in urban and rural areas. The initial increase and later decrease of the monthly rental fee applied to urban areas using market-clearing pricing, appears to raise the telephone density in urban and rural regions because it improves the financial resources of the telecom company and the long-term telephone demand in the urban areas.

A Universal Service Obligations policy has also a counterproductive impact on the system. The implementation of Universal Service Obligations reduces the urban and national telephone densities and the rural telecom infrastructure in the long run. This occurs due to the dynamic behavior generated when the Universal Service Obligation policy is combined with lower willingness to pay for telephone services, and higher operating costs and the obstacles experienced when deploying telecom infrastructure in rural regions. However, if market-clearing pricing is used and the Universal Service Obligation is applied after the urban telephone density reaches about thirty percent while the supply of urban telephone lines equals the demand, the USO policy is able to considerably increase the number of rural subscribers.

It was found that a strategic combination of value added services are able to considerably improve the financial resources of the telecom company and the telephone densities of the country. On the other hand, the implementation of these services in isolation only moderately improved the number of telephone lines. It was also seen that prepaid phone, virtual telephony, and payphone services, which are innovative services over the telephone network, are able to significantly improve the financial resources of the telephone company and the dispersion of telephone lines in urban and rural areas of developing countries, only when implemented together.

Cellular systems are considered the technology currently in the market that is best able to accelerate the dispersion of telephone services in developing countries. This technology was found to considerably improve urban and rural telephone densities, when tested through the simulations. On the other hand, this investigation found that Wireless Local Loop (WLL) could be a viable alternative to improve telephone penetration in spite of its relative high cost, especially in low-density countries and rural areas, where the cost of wired systems considerably increases and the large coverage and low deployment delay of WLL systems become crucial factors on the dispersion of telephone services.

## **Chapter 2 Problem Background**

### **2.1 The Telephone Dispersion Problem in Developing Countries**

Over the past several decades, telecommunications have often been seen as a luxury after other investments, but this concept about telecommunications is changing as more people recognize its contribution to the development of a shared environment that reaches a country's more remote areas and can facilitate political, cultural, economic and social integration (International Cooperation Planning Department of ITU Association of Japan, Inc., 2003). More than fifty percent of the world population lives in rural areas of developing countries. These countries account for forty percent of the total number of telephone lines, although they are about eighty percent of the world population. The 'low-income' developing countries have only five percent of the total number of telephone lines worldwide and they are forty percent of the world population (World Telecommunication Indicators Database, 2004). Their telephone densities are several times greater in the main cities than in provincial towns and rural areas (Saunders et. al. 1994).

The low levels of telephone access, the gap between urban and rural telephone densities, and large waiting lists of telephone subscribers show the existence of a large volume of unmet telephone demand in developing countries, where the supply of telephone lines is lower than the demand (Saunders et. al., 1994; Ros and Banerjee, 2000). The monthly rental fee, the usefulness of the telephone service, and the income per subscriber are considered to influence the demand (Warren, 2002). The usefulness of the telephone service is mainly related to the number of subscribers or telephone



density (Cain and Macdonald, 1991; Madden et al., 2004; Saunders et al., 1994). On the other hand, the supply of telephone lines is constrained by the financial resources available, which are a function of the revenues and operation costs of the telecom company (Kayani and Dymond, 1997).

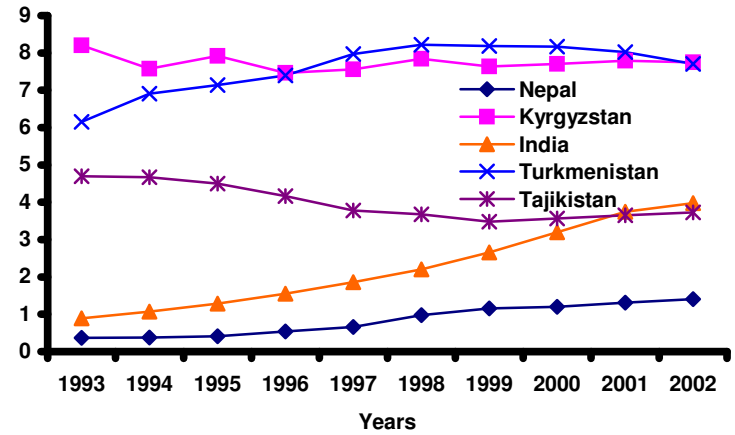
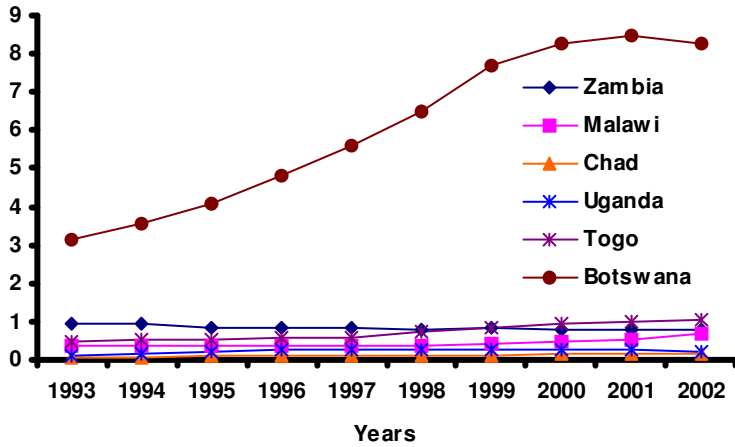
The problem of telephone dispersion in developing countries is observed in Figure 1, which shows the growth of telephones per 100 inhabitants from year 1993 to 2002. It can be seen the very low numbers of telephones lines per 100 inhabitants for several countries in Africa, Asia, and Latin America. These telephone densities are low when compared with densities of developed countries, which are generally higher than 50 telephone lines per 100 inhabitants (World Telecommunications Indicators Database, 2004). The worst situation is found in Africa where the telephone densities for most countries are less than one telephone per 100 inhabitants. Figure 1 shows the telephone densities of 6 African countries: Zambia, Malawi, Chad, Uganda, Togo, and Botswana. The telephone densities in Asia and Latin America are similar and are a little bit better than Africa since they are higher than one. However, these are generally lower than ten telephones per 100 inhabitants. Figure 1 shows the telephone densities of 5 Asian countries: Nepal, Kyrgyzstan, India, Turkmenistan, and Tajikistan, and 4 American countries: El Salvador, Bolivia, Ecuador, and Honduras. However, it can also be observed that in some cases the telephone densities have been reduced, such as the case of Zambia and Tajikistan.

The historical behavior of demand and supply of telecommunications in developing countries is shown in Figure 2. This behavior represents the supply problem

of telephone lines in developing countries, where the waiting list of subscribers are higher than the new telephone lines available to connect (Pahlavan and Krishnamurthy, 2002). The waiting list of subscribers is part of the unmet or unsatisfied demand, which is increased as more customers decide to subscribe to the telephone service. This decision is based on the value the telephone service represents to the potential customer, who considers the price and the usefulness of the service in order to make a decision. On the other hand, the size of the waiting lists is decreased as more new telephones are available. In developing countries, the number of new telephones deployed is a function of the financial resources available and not of the unmet demand.

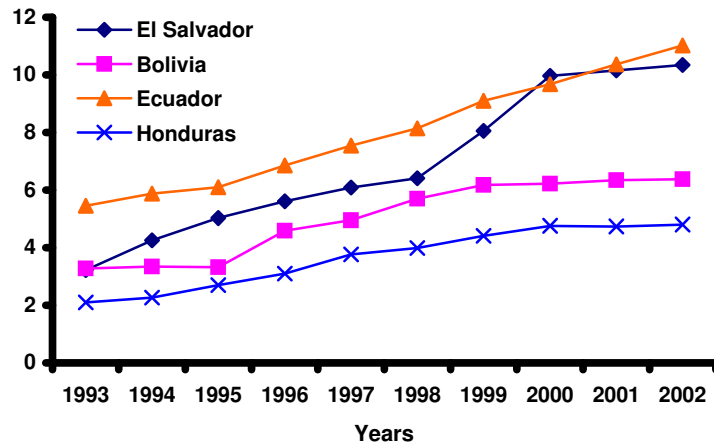
The problem of supply and demand of telephone lines in Nepal, Togo, Sudan, Syria, Botswana, and India is shown in Figure 2, which shows the growth of waiting lists and new telephones installed through time. It can be seen that the waiting lists are growing and are higher than the new telephones lines connected per year. The statistics do not consider the fact that unrecorded demand has been found to be approximately three times the number of orders in the waiting list (Wellenius, 1969). It can also be observed that the gap between the waiting list and the new telephone lines is also growing in several countries, such as the case of Nepal, Togo, Sudan, and Syria. For instance, the waiting lists in Nepal grew from about 50,000 telephones in 1993 to 350,000 in 2001. However, the new telephones installed remained below 50,000 lines. In the same manner, the waiting lists in Sudan grew from 50,000 telephones in 1992 to 450,000 telephones in 2001, and the new telephones installed remained below 100,000 lines. Additional data from several developing countries also confirm this behavior,

where the unmet applications (waiting lists) are even higher than the total supply of telephone lines, which includes the total telephone lines installed and the new telephone lines available to connect (Saunders et. al., 1994).



a) Africa

b) Asia



c) Latin America

**Figure 1. Telephones per 100 inhabitants**  
 Source: World Telecommunications Indicators Database (2004)

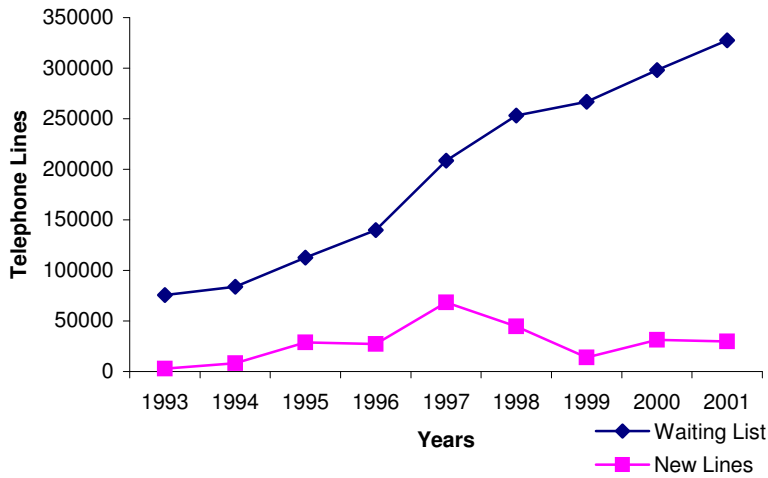


Figure 2a. Nepal's Waiting List vs. New lines

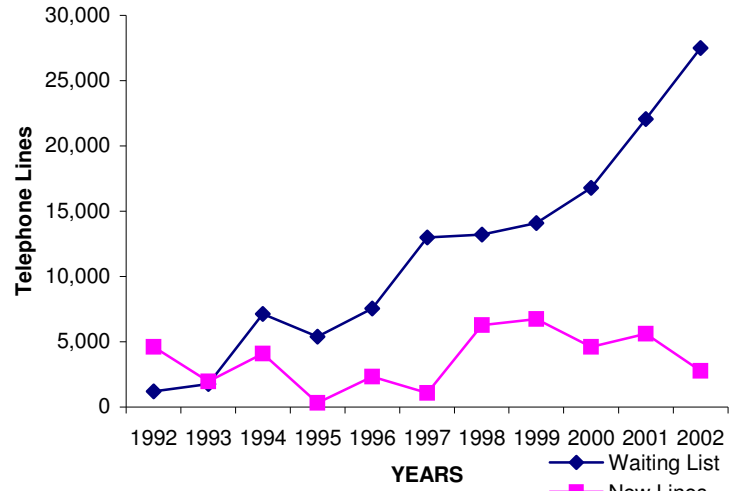


Figure 2b. Togo's Waiting List vs. New Lines

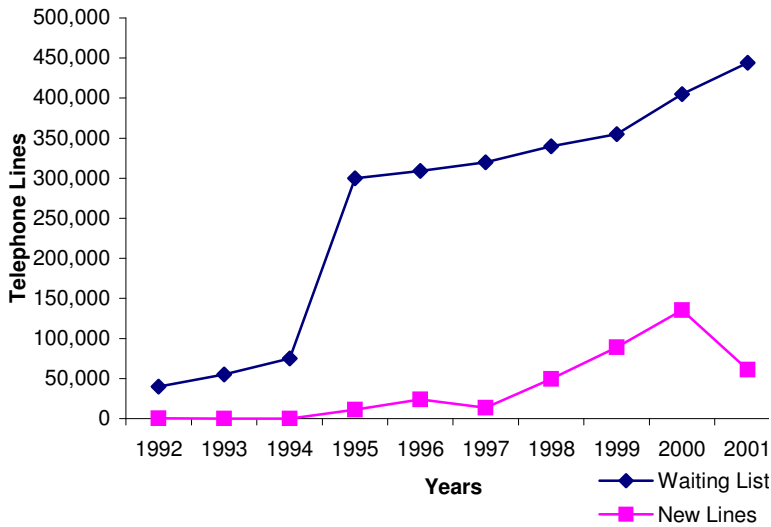


Figure 2c. Sudan's Waiting List vs. New Lines

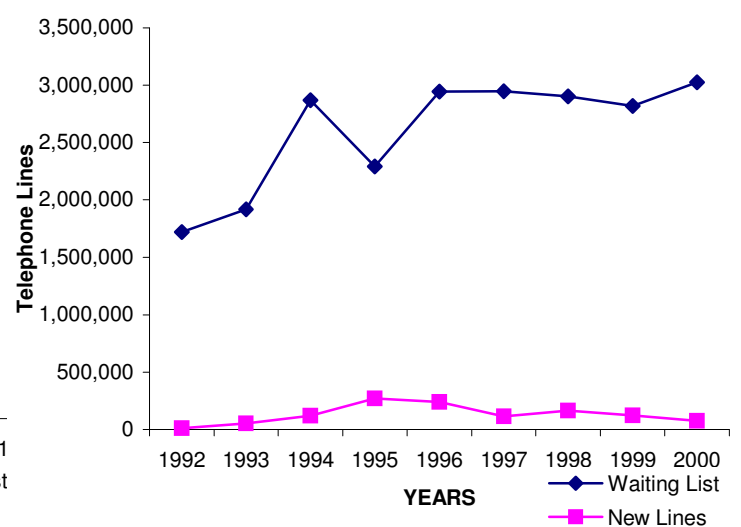


Figure 2d. Syria's Waiting List vs. New Lines

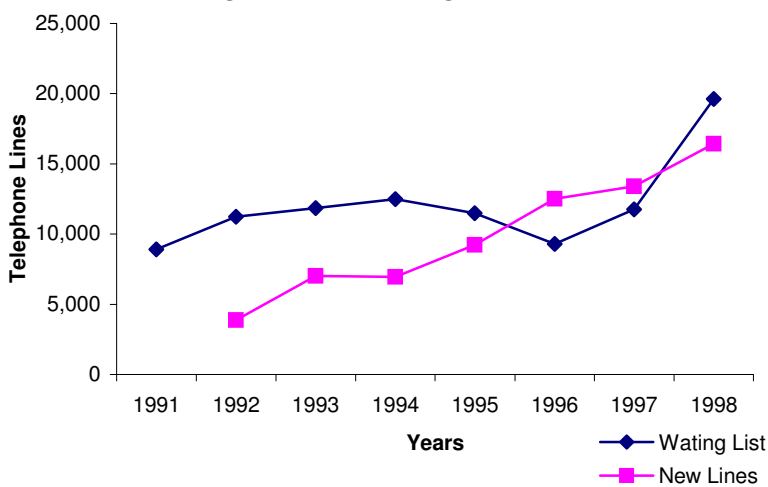


Figure 2e. Botswana's Waiting List vs. New Lines

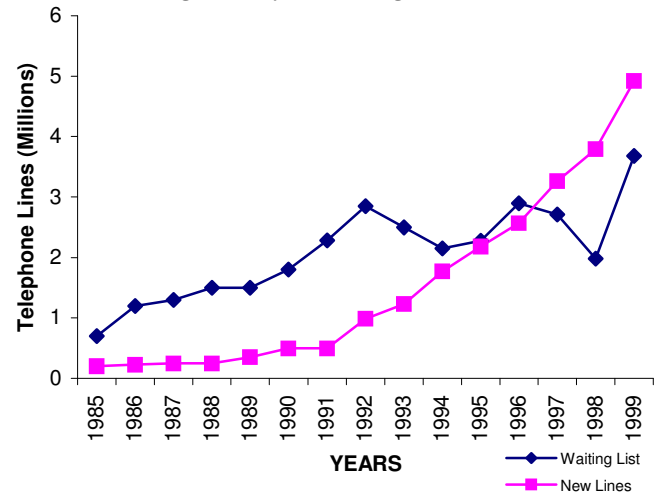


Figure 2f. India's Waiting List vs. New Lines

## Figure 2. Waiting List vs. New Lines in selected Developing Countries

Source: Yearbook of Statistics. Telecommunication Services (2001) and World Development Indicators Database (2004).

## **2.2 Regional Telephone Gap in Developing Countries**

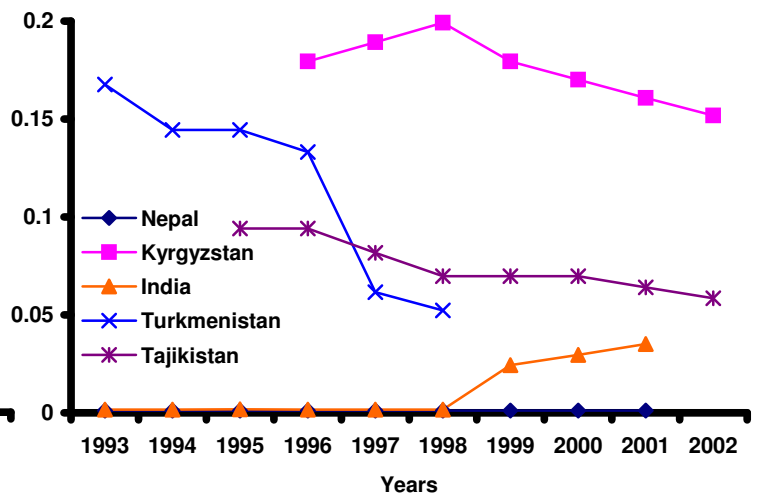
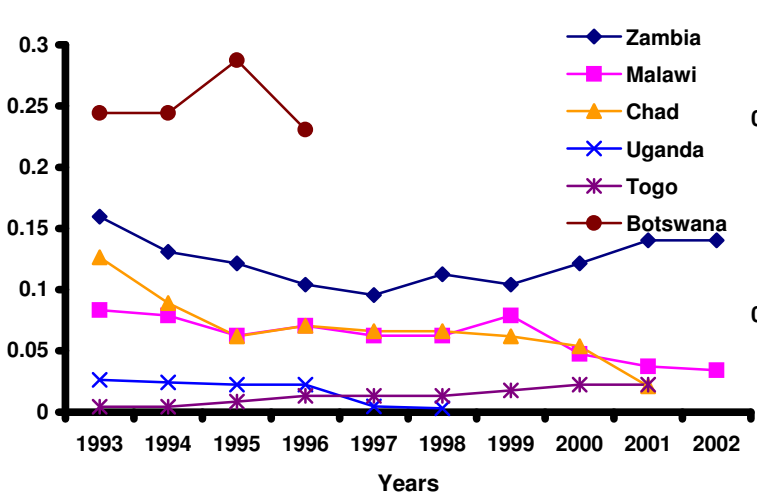
The growth of telephone lines in developing nations has been historically higher in the urban areas, with respect to the rural areas (Saunders et. al., 1994). The data from several developing countries provided by the ITU and other regulatory and statistical entities of developing countries support this trend between urban and rural telephone lines (Yearbook of Statistics. Telecommunications Services, 2001; World Telecommunications Indicators Database, 2004; OSIPTEL of Peru; Superintendencia de Telecomunicaciones of Bolivia; Department of Telecommunications of India; and Bangladesh Bureau of Statistics).

Figure 3 shows the telephone density gap between rural and urban areas in several developing countries of Africa, Asia, and Latin America. This figure shows the ratio between rural and urban telephone densities. It can be seen that this ratio is less than 0.3 in all three continents, which indicates that the telephone densities in the urban areas are higher than three times the telephone densities in the rural areas. In most cases, this ratio is decreasing, which shows that the telephone densities in the urban areas are increasing faster than in the rural ones. This situation leads to an increase in the regional telephone gap in developing countries through time.

The regional telephone density gap of Zambia, Malawi, Chad, Uganda, Togo, and Botswana, which are developing countries from Africa, are shown in Figure 3. The ratio between rural and urban telephone densities is less than 0.3 for all these countries, which means that telephone densities in urban areas are higher than three times the telephone densities in rural areas. In addition, it can also be seen that this ratio is

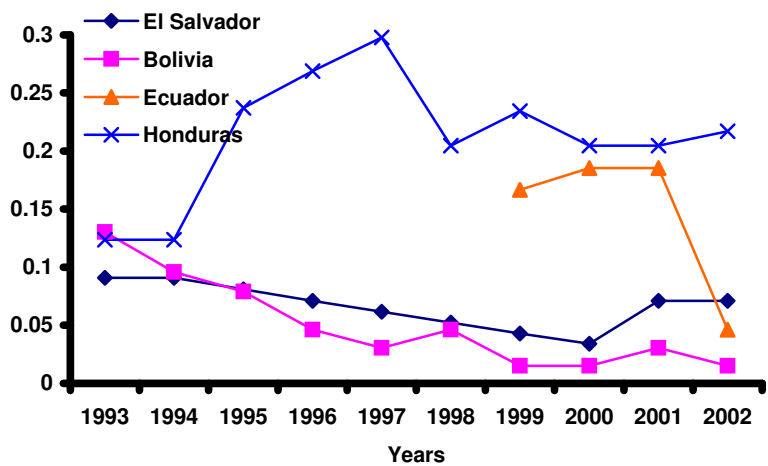
decreasing for Botswana, Chad, Malawi, and Uganda, which indicates the worsening of the rural-urban telephone gap through time for these countries. The rural-urban telephone density ratios for Nepal, Kyrgyzstan, India, Turkmenistan, and Tajikistan, which are Asian developing countries, are also observed in this figure. It can be seen that this ratio is less than 0.2 for all these countries, which indicates that telephone densities in urban areas are higher than five times the telephone densities in rural areas. In addition, it can also be seen that the rural-urban telephone gap is also getting worse for India, Turkmenistan, and Tajikistan, since their rural-urban telephone density ratios are also decreasing through time. The same behavior is also observed in Figure 3 for El Salvador, Bolivia, Ecuador, and Honduras, which are developing countries from Latin America. The rural-urban telephone density ratios are also less than 0.3 and are decreasing for El Salvador, Bolivia, and Ecuador.

The higher dispersion of telephones in urban areas has been attributed to the higher income per capita of the urban population, and the lower implementation costs than the rural case, which restricts the telecom operator investment in more profitable urban areas (World Bank, 2002). Previous research has found that income is the most important variable that influences both demand of telephone lines and telephone traffic (Saunders et. al., 1994). The income per capita in urban regions is higher than the income per capita in rural areas. Therefore, the telephone traffic generated per subscriber in rural areas is lower than it is in urban areas (Hudson, 1984).



a) Africa

b) Asia



c) Latin America

Figure 3. The Rural-Urban Telephone Density Gap

Source: Estimated from World Telecommunications Indicators Database (2004) and World Development Indicators (2002)

### **2.3 Unsuccessful Telecommunications Policies in Developing Countries**

The World Trade Organization (WTO) agreement of 1997 established international commitments in the telecom sector for its country members. This implied the transformation of the telecom law and regulations in order to align the country objectives for the telecom sector with the international ones. Among the main policies suggested by this agreement are the implementation of universal service, the autonomy of the telecom regulator, free market for telecom services, and reduction of regulation (The Telecommunications Development Bureau of ITU and CITELE, 2000).

The achievement of universal service indicated in the WTO agreement involves the development of telecom infrastructure in rural areas of developing countries. Universal service can be defined by the provision of “universal” availability of connections to individual households from public telecommunication networks, with non-discriminatory and affordable prices (Hank and McCarthy, 2000). An alternative to universal service is “universal access”, which is defined by a situation where every person has a reasonable means of access to a publicly available telephone. In practice, progress toward universal service has been measured by the percentage of households with telephone service (Cain and Macdonald, 1991).

Several policies and strategies have been implemented in the past by many governments and institutions without success in order to solve the problem of universal service in telecommunications (Malecki, 2003; Melody, 1999; Strover, 2003). Among the most important policies are the privatization and liberalization of the telecom



market, Universal Service Funds, Universal Service Obligations, International Cross-Subsidies, and grant-based funding.

Previous studies have found the failure of private provision of services and infrastructure, such as telecommunications. The privatization of several services such as, airlines, bus services, and medical services has been related to the telecom privatization. After studying the failure on expanding their services to rural regions, it has been suggested that due to little revenue potential and high costs of the services, private companies are reluctant to serve rural areas (Calhoun, 1992). In a similar fashion, Khalid Saeed and Xu Honggang, using a System Dynamics approach, found that privatization of infrastructure delivery would create several problems, since private sector organizations are often not designed to deliver public goods (Saeed and Honggang, 2004). In addition, in a study of 30 African and Latin American countries between 1984 and 1997, privatization of telecommunications was found to be negatively related to main line penetration and connection capacity (Wallsten, 1999). Finally, it was observed that after telecom privatization in South Africa, almost two-thirds of the new additional lines installed were disconnected as many of the newly connected lower income households were unable to keep up with the payments (Hodge, 2004).

The Universal Service Fund is a strategy implemented in more liberalized markets. It uses resources obtained from several network and service operators to finance capital expenditures on rural network deployment (Siochru, 1996). This type of fund has been organized and managed by telecom regulators, who have had limited

success in adapting the universal service goal to a competitive environment. The management of the fund has been difficult due to problems in accurately measuring the costs of universal service provision, and setting up funding mechanisms that are efficient, equitable and that distort the market as little as possible (Duckworth, 2004). For instance, in Ecuador, CONATEL, the Ecuadorian telecom regulator, was unable to raise enough economic resources to finance significant telecom projects for the rural areas, and reduce the gap in telecom infrastructure between rural and urban regions of the country (Finance, Private Sector, and Infrastructure Development of World Bank, 2001). In Ghana, the government plans to charge all operators a tax to create a fund for rural development but the fund still does not exist. In Ivory Coast, the fund exists but has not yet been used (Laffont and N’Gbo, 2000).

Finally, the grant-based funding uses resources from the general budget to subsidize the deployment of telecom infrastructure (Kayani and Dymond, 1997). This strategy was found to improve considerably telecom penetration in developing countries (Ramos and Gerstenfeld, 2004), although it uses scarce economic resources that are generally unavailable for telecommunications investment. In addition, there are still several questions regarding the sustainability of the implementations, since there have been cases where the expansion of telecom infrastructure did not translate into sustainable projects. For instance, a rural telecom company from Chile, which has been subsidized by the government for implementing rural telecom projects, has been losing money (Wellenius, 2002).

## **2.4 Universal Service Obligations and International Cross-Subsidies**

The principles dictated by welfare economics say that the price of each product or service should be set equal to its marginal cost, and output should be expanded to meet resulting demand at those prices. In this context, there should not be cross-subsidization, whereby one service is priced above marginal cost to finance the supply of a service at a price below marginal cost (Littlechild, 1979).

On the other hand, the cross-subsidies in telecommunications have been regarded as a useful mechanism for expanding networks in rural and poor areas of developing countries (Laffont and N’Gbo, 2000), even in the presence of competition (Gasmi et al., 2000). It has been proposed that cross-subsidizations through the provision of telecommunications at prices below cost may sometimes be desirable in order to spread the benefits of telecom access to disadvantaged and rural remote areas, where the cost of providing access is generally higher than in urban areas, the total traffic generated is relatively low, and the telecom income from the service provision is also low (Saunders et. al., 1994; The Telecommunications Development Bureau of ITU, and CITELE, 2000). These cross-subsidizations are supposed to create positive network, call, and social externalities, which should improve rural development and social efficiency and benefit (Crandall and Waverman, 2000; Saunders et al., 1994). The question addressed in this investigation is whether the intended improvement will actually happen in the long term given that there exist differences in income per capita and willingness to pay, telephone deployment and operating costs, and telephone deployment delays in urban and rural areas.

In several developing countries, cross-subsidization has been applied by overcharging for international long distance and providing local access below cost, and by applying Universal Service Obligations fees to telecom investment in less profitable rural areas (Kayani and Dymond, 1997). These cross-subsidization policies have been implemented in the past with the objective of increasing telephone density and promoting universal service in telecommunications. Universal service in telecommunications is part of the World Trade Organization (WTO) agreement of 1997 and involves the development of telecom infrastructure in rural areas (The Telecommunications Development Bureau of ITU, and CITELE, 2000).

These types of subsidies are typical for telephone services that are regulated and mandated by the government to provide an affordable and accessible service, such as the case of the fixed 'wired' telephone service in most developing countries. On the other hand, the cellular telephone service, which is less regulated or more liberalized, is not significantly affected by these cross-subsidies. However, it was explained before that private telecom providers do not prefer to extend the service to unprofitable rural areas and are often not designed to deliver public goods (Calhoun, 1992; Madden et al., 2004; Saeed and Honggang, 2004).

#### **2.4.1 International Cross-Subsidies.**

Traditionally the tariffs for telecom services have been based in political and social objectives, including advancing universal service, the result is the generation of cross-subsidies. These cross-subsidies can occur between different services, geographic

regions, and groups of consumers (The Telecommunications Development Bureau of ITU and CITELE, 2000). It could also be understood as a complex price averaging of services executed by telephone companies (Cronin et. al., 1997).

Most regulators and telephone operating entities have traditionally favored charging below cost monthly rental fees in urban and rural regions, and overcharging for international services (Hank and McCarthy 2000). In most countries, this international cross-subsidy has been preferred over the one from domestic long-distance service, hence the international prices have been set much higher than the local long-distance prices. This has occurred in spite of the fact that there is not significant cost difference between the domestic and international services (The ITU Secretariat, 1998).

This international cross-subsidy has been applied in order to create positive externalities making basic services affordable and thus achieving maximum penetration feasible among users with low incomes (Crandall and Waverman, 2000). The World Bank has reported many cases of developing countries where the international revenue through its net settlement component, represents more than fifty percent of the income of the telephone operator (Primo et al., 1999). These below cost monthly rental fees have been applied in urban areas even though the urban willingness to pay for telephone access, which has been assumed twenty five percent of the willingness to pay for telephone services, has been found to be higher than the monthly rental fee. Telecom companies in Argentina have reported that local access represents more than twenty five percent of the revenue in urban areas (Goussal and Udrizar, 2000). In addition, it has also been observed that urban telephone access, which depends on the monthly rental

fee, is considerably inelastic when compared with rural areas (GAS 5 Economic Studies at the National Level in the Field of Telecommunications, 1984; Goussal and Udrizar, 2000).

The international cross-subsidy obligates operators to use funds obtained from international calls, to invest in the expansion of the urban and rural telecom network while maintaining the local prices and fees at low values in order to increase demand and telecom penetration. The common rationality of cross-subsidization is that users cannot afford to pay the full cost-based fee for service due to high costs involved in its implementation and operation (Kayani and Dymond, 1997). The provision of telecommunications at prices below cost may sometimes be desirable in order to spread the benefits of telecom access to smaller towns or rural remote areas, where the cost of providing access is generally higher than it is in urban areas, the total traffic generated is relatively low, and the telecom income from the service provision is also low (Saunders et. al., 1994).

In developing countries, the urban and rural monthly rental fees have been held down under the common rationality of pricing basic service below cost in order to generate positive externalities and support the universal service policy. These externalities include network, call, and social externalities, which are generated by the action of one individual that benefits others without a corresponding payment, or revenue flow, to the individual generating them (Crandall and Waverman, 2000).

Table 1 shows a list of countries that have applied cross-subsidization by holding the monthly rental fee at considerably lower values than the operating costs and

at the same time overcharging for its international service. This situation is observed in the ratio of operating costs per telephone line to monthly rental fee in urban areas and in the cost of a 3-minute call to the United States from these developing countries. For instance, the ratio of urban operating costs per line to the urban monthly rental fee in Zambia is 20.25, which indicates that the operating costs per line are more than twenty times higher than the monthly rental fee in urban areas. On the other hand, it can also be observed that the international price of a 3-minute phone call from Zambia to the United States is 2.57 dollars, which has been used to create the international cross-subsidy. In the same manner, the operating costs per line in Botswana are thirty eight times higher than monthly rental fee in urban areas, and the international price of a 3-minute phone call from Botswana to the United States is 3.6 dollars. The operating costs per line in Bolivia are twenty five times higher than the monthly rental fee in urban areas, and the international price of a 3-minute phone call is 3.7 dollars.

It is also observed that monthly rental fee is much lower than the willingness to pay for telephone access in urban areas, which indicates that local telephone access is underpriced. This can be observed in the ratio of willingness to pay for telephone access to monthly rental fee in urban areas. The ratio of urban willingness to pay for telephone access to urban monthly rental fee in Botswana is 8.39, which indicates that access willingness to pay is higher than eight times the monthly rental fee in urban areas. Similarly, the access willingness to pay in Bolivia is higher than three times the monthly rental fee in urban areas. In the same manner, the access willingness to pay in Thailand is higher than fourteen times the monthly rental fee in the urban areas.

The willingness to pay for the telephone service has been defined as five percent of the income per household (Hank and McCarthy, 2000; Kayani and Dymond, 1997), since the International Telecommunications Union (ITU) has determined that household expenditure in telecommunications could be up to five percent of the income (Milne, 2003). The operating cost has been defined as thirty percent of the capital costs, which is the world average. The cost per line is defined as a function of the cable distance, which is a function of the population density (Kayani and Dymond, 1997; Calhoun, 1992; Webb, 2000).

The capital costs per line depend on the average cable distance from the central office to the subscribers (Kayani and Dymond, 1997). It is defined as a function of the population density and a referential number of telephone lines per central office, which is assumed five thousand. As a reference, the cost of a telephone line in urban areas of Ecuador has been previously estimated below five hundred dollars (Plaza, 2005). The urban income per capita is defined as a function of the non-agricultural income and the urban population density depends on the urban area, which it assumes represents ten percent of the land area (Kayani and Dymond, 1997).



Country	Urban Income per Capita (US dollars)	Urban Access Willingness to Pay (US dollars)	Monthly Rental Fee (US dollars)	Urban Access W. to Pay / Mo. Fee Ratio	Urban Population Density (pop/km2)	Urban Cost per Line (US dollars)	Urban Operating Costs (US dollars)	Op. Cost / Mo. Fee Ratio	Cost of Call to US \$ per 3 minutes (year 2000)
Zambia	498	2.07	1.14	1.82	58	921	23.02	20.25	2.57
Bolivia	1230	5.13	1.62	3.17	47	1003	25.07	15.50	3.7
Ecuador	1708	7.12	6.20	1.15	284	515	12.87	2.07	4.9
Honduras	1599	6.67	2.43	2.74	252	535	13.39	5.50	4.2
Thailand	8155	33.98	2.33	14.60	262	529	13.21	5.68	2.5
Botswana	5088	21.20	2.53	8.39	17	1548	38.71	15.31	3.6
Colombia	2329	9.70	2.68	3.62	277	519	12.97	4.84	2.2

**Table 1. International Cross-Subsidies in selected Developing Market Economies.**

Source: World Telecommunications Development Report (2001). Data estimated from: World Telecommunications Indicators Database (2004), World Development Indicators (2002)

#### **2.4.2 Universal Service Obligations**

Governments and regulatory authorities have created Universal Service Obligations to generate positive network, call, and social externalities and guarantee service above a certain threshold to rural areas, which are intended to accelerate rural development and to improve the social efficiency in developing countries. The Universal Service Obligations give priority to investment into rural areas, which usually go beyond the feasible cost/revenue limits and require cross-subsidization from more profitable urban regions and services (Kayani and Dymond, 1997). These obligations have been applied by increasing the investment in rural telecom capacity, even though there is evidence of higher operating costs and lower willingness to pay in rural areas with respect to urban areas. This process is expected to result in a faster expansion of

rural telecom infrastructure, but it is achieved at the expense of limiting service to urban and high-density areas (Goussal and Udrizar, 2000).

Table 2 shows a list of countries that have applied Universal Service Obligations, even though the ratio of willingness to pay to operating cost per line is much higher in urban areas with respect to rural areas. The ratio of willingness to pay to operating costs per line in the urban areas of Botswana is 0.88. This ratio is much higher than 0.01, which is the ratio of willingness to pay to operating costs per line in the rural areas. This shows the higher willingness to pay for telephone services and lower operating costs per line in the urban areas with respect to the rural areas in Botswana. Similarly, in Honduras, the ratio of willingness to pay for telephone services to operating costs per line in urban areas is 0.8, which is much higher than 0.07, the ratio of willingness to pay to operating costs per line in the rural areas. In the same manner, the ratio of willingness to pay for telephone services to the operating costs per line in the urban areas of Nepal is 0.55, which is much higher than 0.05, the ratio of willingness to pay for telephone services to operating costs per line in the rural areas. As indicated before, this shows the higher willingness to pay for telephone services and lower operating costs per line in the urban areas with respect to the rural areas in Nepal.

It is also observed that the willingness to pay is higher in urban areas because of the higher incomes per capita in these regions. The willingness to pay for telephone services in the urban areas of Bangladesh is eight dollars, which is much higher than one dollar, the willingness to pay for telephone services in the rural areas. This is proportional to the income per capita of the urban and rural population in Bangladesh.

The income per capita in the urban areas of Bangladesh is 1,143 dollars and the income per capita in the rural areas is 120 dollars. Similarly, the willingness to pay for telephone services and the income per capita of the urban population in Honduras is 11 dollars and 1,599 dollars respectively. On the other hand, the willingness to pay for telephone services and the income per capita of the rural population in Honduras is 2 dollars and 311 dollars respectively.

The operating costs are found to be higher in rural areas because of the lower population densities, which increase the cost of a telephone line and the capital costs. For instance, the rural operating costs in Ecuador are much higher than the urban operating costs. The rural population density of Ecuador is 19 people per square kilometer and the rural operating cost per line is thirty-seven dollars per month. On the other hand, the urban operating cost per line in Ecuador is thirteen dollars per month and its urban population density is 284 people per square kilometer. Similarly, the urban operating cost per line in Bolivia is twenty-five dollars per month, which is much lower than eighty-eight dollars per month, the rural operating cost per line. These values are inversely proportional to the urban and rural population densities. The Bolivian urban population density is 47 people per square kilometer and its rural population density is 3 people per square kilometer.

Table 3 shows details of the application of Universal Service Obligations in selected developing countries from Asia, Africa, and South America. Several countries in Asia have adopted Universal Service Obligations in order to expand rural telecommunications. The government of India created the “Universal Service

Obligation”, which requires the installation of ten percent of their total installed capacity in rural areas from all telecom operators (Hank and McCarthy, 2000; Peha, 1999). In Nepal, the telecom regulatory authority mandates telecom operators to provide rural telecommunications in the entire country (Nepal Telecommunications Authority, 2004). The license of the telecom operator in Bangladesh obliges the installation of one exchange in each sub-District or Thana. In Pakistan, the telecom operator was mandated to install 150,000 new telephone lines in rural areas to reach villages with over 1,000 inhabitants and achieve a rural telephone density of 0.2 lines per 100 inhabitants by 1998. In Thailand, the government mandated the expansion of the telephone service to cover all villages with 2 lines in each sub-village (Kayani and Dymond, 1997).

Africa seems to follow in the footsteps of Asia regarding the implementation of Universal Service Obligations. The government of Botswana mandated the state-owned telecom company to serve all identifiable demand in villages with a population higher than five hundred by the year 2000 (Kayani and Dymond, 1997). The government of Togo recently mandated the extension of rural telecommunications by providing a telephone within a distance of less than 5 km by 2010 (The Sun News On-Line, 2004).

In Latin America several countries have implemented Universal Service Obligations either in their national programs or as part of the carrier’s license agreement. The privatized telecom company in Bolivia, ENTEL, has spent forty percent of its expansion budget on rural areas. The government of Honduras has a telecom Rural Master Plan, which gives rural areas priorities for investment. The telecom

operators in Ecuador are mandated to deploy rural telecommunications as part of their license agreement (Kayani and Dymond, 1997).

Country	Income per Capita (dollars)		Willingness to Pay (dollars)		Population Density (pop/Km2)		Operating Cost (dollars)		Willingness to Pay / Operating Costs	
	Urban	Rural	Urban	Rural	Urban	Rural	Urban	Rural	Urban	Rural
Togo	488	147	8	2	289	65	13	22	0.64	0.11
Nepal	1217	111	20	2	188	153	15	16	1.37	0.12
India	1199	155	20	3	865	247	9	13	2.15	0.19
Bangladesh	1143	120	19	2	2183	768	8	10	2.53	0.21
Pakistan	884	182	15	3	641	121	10	17	1.46	0.18
Bolivia	1230	644	21	11	47	3	25	88	0.82	0.12
Ecuador	1708	310	28	5	284	19	13	37	2.21	0.14
Honduras	1599	311	27	5	252	32	13	30	1.99	0.18
Thailand	8155	256	136	4	262	103	13	18	10.28	0.23
Botswana	5088	212	85	4	17	2	39	107	2.20	0.03

**Table 2. Indicators of Selected Developing Market Economies with Universal Service Obligations**

Source: Data estimated from World Development Indicators (2002)

<b>Country</b>	<b>UNIVERSAL SERVICE OBLIGATION</b>
<b>Togo</b>	The government of Togo recently mandated the extension of rural telecommunications by providing a telephone within a distance of less than 5 km by 2010.
<b>Nepal</b>	The telecom operators are obliged to make a contribution to the rural telecommunications fund annually for rural telecom projects.
<b>India</b>	It demanded the installation of ten percent of their total installed capacity in rural areas.
<b>Bangladesh</b>	The license of operation obliged the installation of one exchange in each sub-District (Thana)
<b>Pakistan</b>	The installation of 150,000 new telephone lines in rural areas to reach villages with over 1,000 inhabitants and achieve a rural telephone density of 0.2 lines per 100 inhabitants by 1998.
<b>Bolivia</b>	The privatized telecom company ENTEL spends 40% of its expansion budget on rural.
<b>Ecuador</b>	Rural telecommunications is part of the operation license of the telecom operators
<b>Honduras</b>	The country has a telecom Rural Master Plan, which gives rural areas priorities of investment.
<b>Thailand</b>	The expansion of telephone service to cover all villages with 2 lines in each sub-village.
<b>Botswana</b>	The government mandated the telecom operator to serve all villages with a population higher than five hundred people.

**Table 3. Universal Service Obligation Policies in selected Developing Market Economies.**

**Source: Kayani and Dymond (1997), Peha (1999), The Sun News On-Line (2004), Nepal Telecommunications Authority (1994)**

## **2.5 Performance of Universal Service Obligations and International Cross-Subsidies in Developing Countries.**

Table 4 shows that the International Cross-Subsidies applied in developing countries had little effect on improving the dispersion of telephone services. For instance, in Zambia the overall as well as urban and rural telephone densities were reduced, in spite of the application of the Internal Cross-Subsidy indicated in Table 1. The monthly rental fee in Zambia is about twenty times less than the operating cost, and two times lower than the willingness to pay for telephone access in urban areas. The below cost monthly rental fee is implemented by charging high prices for international traffic. In the same manner, in Bolivia and Colombia the telephone densities experienced little improvement and the rural telephone densities were reduced. This increased the telephone gap between urban and rural regions, in spite of implementing monthly rental fees that are much lower than the urban operating costs and the willingness to pay for telephone access.

The application of Universal Service Obligations has also done little to improve the telephone density and especially the penetration of rural telephone lines in other developing countries, as observed in Table 4. For instance, in Bangladesh the penetration of telephone lines in rural areas grew from 0.03 lines per 100 inhabitants in 1993 to 0.05 lines per 100 inhabitants in 2002, which did not reduce the service gap between urban and rural regions. In Bolivia and Ecuador the overall telephone densities had little improvement and the rural telephone densities were reduced. This increased

the urban-rural telephone gap and occurred in spite of the application of the USO policies described in Table 3.

The model developed in this dissertation investigates if the society is going to benefit by overcharging for international services and charging monthly rental fees below cost, and by applying Universal Service Obligations in terms of achieving higher telephone densities and reducing the rural-urban telephone gap.

Countries	Telephone Density Lines per 100 Inhab		Urban Telep. Density Lines per 100 Inhab		Rural Telep. Density Lines per 100 Inhab		% Rural Lines		Rural/Urban Telep. Density Gap		Telecom Policies	
	1993	2002	1993	2002	1993	2002	1993	2002	1993	2002	USO	INT
Zambia	0.92	0.81	1.89	1.70	0.30	0.24	20	18	0.160	0.140		√
Togo	0.45	1.05	1.59	3.12	0.01	0.08	1	5	0.004	0.025	√	
Nepal	0.37	1.41	4.07	12.69	0.00	0.02	1	1	0.001	0.001	√	
India	0.89	3.98	3.20	10.38	0.12	1.49	10	27	0.037	0.144	√	
Bangladesh	0.21	0.46	0.99	1.84	0.03	0.05	10	8	0.026	0.026	√	
Pakistan	1.24	2.5	3.68	6.25	0.09	0.39	5	10	0.025	0.063	√	
<b>Low Income</b>	<b>0.68</b>	<b>1.70</b>	<b>2.57</b>	<b>6.00</b>	<b>0.09</b>	<b>0.38</b>	<b>8</b>	<b>12</b>	<b>0.042</b>	<b>0.066</b>	<b>5</b>	<b>1</b>
Bolivia	3.28	6.37	5.39	10.23	0.60	0.33	8	2	0.111	0.032	√	√
Ecuador	5.45	11.02	8.92	16.97	1.21	0.89	10	3	0.136	0.053	√	√
Honduras	2.1	4.81	4.45	7.83	0.40	1.67	11	17	0.090	0.213	√	√
Thailand	3.93	10.5	13.24	27.00	1.75	6.11	36	46	0.132	0.226	√	√
Botswana	3.12	8.28	5.86	13.18	1.22	3.57	23	22	0.208	0.271	√	√
Colombia	8.46	17.94	8.95	24.08	7.37	1.33	27	2	0.823	0.055		√
<b>Middle Income</b>	<b>4.39</b>	<b>9.82</b>	<b>7.80</b>	<b>16.55</b>	<b>2.09</b>	<b>2.32</b>	<b>19</b>	<b>15</b>	<b>0.250</b>	<b>0.142</b>	<b>5</b>	<b>6</b>

**Table 4. The Dispersion of Telephones in Selected Developing Market Economies with USO and International Cross-Subsidies.**

Source: World Telecommunications Indicators Database (2004), Kayani and Dymond (1997), Peha (1999), The Sun News On-Line (2004), Nepal Telecommunications Authority (2004). Data estimated from World Development Indicators (2002).



## **Chapter 3 Methods of Analysis for Telecom Planning and Policies**

### **3.1 The Failure of Current Methods for Telecom Planning and Policy Design.**

The current policies and strategies for increasing telecommunications deployment in rural areas are often insufficient or unsuccessful, and the plans for expansion of local telephone networks are generally imprecise considering the scope of the investment (Malecki, 2003; Melody, 1999; Strover, 2003; Calhoun, 1992). The telecom gap between urban and rural regions and between the rich and poor people has not improved using current policies and strategies (Saunders et. al., 1994; Kayani and Dymond, 1997; Malecki, 2003; Cain and Macdonald, 1991). In addition, conventional management rationality such as the ‘Get Big Fast’ strategy triggered the biggest crises of the telecom industry: the Internet stock bubble in the late 1990s and the ‘dot.com’ crash of business to consumer (B2C) electronic commerce companies of the year 2000 (Oliva et. al., 2002)

One of the conventional methods used for telecom planning and policy design is the use of econometric modeling. This uses statistical methods to verify and quantify economic theory, which relies on statistical verification of model structure and parameters by tying the models firmly to statistical observations of real world systems. The econometric analysis uses correlated rather than directly causally related variables to proceed in spite of the empirical validation requirement (Meadows, 1980).

The econometric modeling requires representing economic systems as linear, which allows the mathematical estimation of parameters; and includes fudge factors to

the output of a model with the purpose of fitting modeler's intuition (Serman, 2000). There is a problem related to the different estimation techniques used in econometric analyses, it has led to different conclusions about the effects of specific telecom policies in developing countries (Fink et. al., 2003). For instance, there are different conclusions about the impact of telecom privatization using econometric modeling. Wallsten found in a study of 30 African and Latin American countries between 1984 and 1997, that privatization of telecommunications was negatively related to main line penetration and connection capacity, and Ros and Banerjee found that telecom privatization is good for telecom expansion (Wallsten, 1999; Ros and Banerjee, 2000). In addition, counterproductive telecom policies could be derived as a result of the application of this methodology. Saeed and Honggang have proved that privation of public telephone services might not be good for telephone dispersion and achieving universal service in telecommunications ( Saeed and Honggang, 2004).

The survey analysis for collecting and analyzing data is another common conventional methodology for telecom planning and policy design. This methodology requires designing questionnaires and distributing them over a target population, in order to gather information, such as the experiences, knowledge, opinions, or perceptions, from the main stakeholders of the system. The problems found in this methodology are related to the design of the questionnaires, which could be biased or poorly elaborated, and to the population surveyed, which could not be big enough or representative of the problem being studied. In addition, it relies on the limited rationality, and understanding of the problems related to the complex telecom system,

of the people being surveyed. For instance, a survey that collected information from the main representatives of the telecom sector in African countries suggested the policy of increasing the investment in rural areas of developing countries for improving teledensity (Mbarika, 2001). This policy was based on the experiences, knowledge, and perceptions of the main stakeholders of the telecom sector in the African countries, and relied on their limited and linear ability to understand the complex and dynamic structure of the regional telecom system, which will be described later in this dissertation. This thesis and previous studies show that this policy is counterproductive, since this does not consider the dynamic behavior, which is generated when it is applied to the regional telecom system. The regional telecom system includes the economical, demographic, and social differences between urban and rural areas in developing countries (Ramos and Gerstenfeld, 2004; Ramos et. al., 2005).

The international 'best practice' benchmarking approach uses a broad range of indicators, which provide an overall picture of relative performance in the telecom sector. This is considered constructive since, by helping to raise awareness of relative performance, it can exert the pressures of 'best practice' and focus remedial attention on the areas with the most potential for performance improvement. This approach is supported by international organizations such as the International Telecommunications Union through its World Telecommunications Indicators Database, and The World Bank, which has designed the World Development Indicators report.

The highly imperfect nature of markets, and the enormous income disparities and inequities that exist in developing countries, make the international 'best practice'

approach insufficient to meet the challenges of universal service in telecommunications (Gillwald, 2005). The performance monitoring of the international benchmarking approach is a very complex assignment, since a range of assumptions are involved and simplifications are necessary regarding the meaning of the indicators, which are needed for international comparability. In addition, many of the indicators have shortcomings. For instance, it can be difficult to draw conclusions based on comparisons of absolute numbers or ratios because of different accounting or technical definitions and different demographic, economic, geographic and regulatory environments (Xavier, 1996).

There are other methodologies and tools for telecom planning such as the net present value (NPV), which is a widely used financial management measurement. This parameter compares the value of a dollar today to the value of the same dollar in the future, taking inflation and returns into account. If the NPV of a prospective project is positive, it should be accepted. However, if the NPV is negative the project should probably be rejected because cash flows will also be negative (<http://www.investopedia.com>). The problem with this planning measure is that it disregards the relevance of the actual time when the cash inflows and outflows of the telecom company occurred. This is an important issue in telecom planning since a telecom project that required a huge investment during the first year, such as conventional wired technology, could be chosen over other projects that delayed most of the investment to future years, such as wireless technologies (Webb, 2000).

The current methods to design policies and strategies do not consider an analysis and definition of the causal structure of the system. This is, the econometric, survey,

international benchmarking, and net present value analysis do not consider the structure of the regional telecom system for policy and strategy design. In addition, the use of microeconomic theory and the 'future scenario' technique do not involve the study of the dynamic relationships between the different elements of the telecom system either. The 'future scenario' technique has been used to anticipate customer expectations, economical constraints, and potential business models for telecom operators, which considers current trends in science and technology in order to project likely images of future societies (Unbehaun, 2002; Flament et. al., 1999)

### **3.2 System Dynamics as a Methodology for Policy Design and Planning of Rural Telecommunications.**

The previous section described some clear problems related to the conventional methodologies used for telecom planning and evidenced the need of a more effective and appropriate methodology. The need for a systems framework to analyze the complexity of the rural telecommunication system and the importance of focusing on economic and social aspects rather than only the technological ones has been recognized to some degree (Andrew and Petkov, 2003). In addition, the importance of a procedure for rural telecom planning that can react to changing circumstances in a dynamic manner has been previously supported (Walsham, 1979), and a systematic investigation of the determinants of diffusion of mobile telecommunications, which could be used for rural telecommunications, has been previously recommended (Gruber, 2001). The adoption of new modeling practices for the telecommunications industry,

which can incorporate the trade-offs raised by the emergence of wireless access alternatives, especially when applied to rural environments, has been suggested (Calhoun, 1992).

Telecom planning using a long-term and non-linear system dynamics approach as compared to 'tactical' approaches, which are reactive, short-term, and linear, has been advocated (Lyneis, 1994). The definition of the dynamic hypothesis in the system dynamics methodology determines the structure of the regional telecom system, which incorporates the social, economic, and demographic variables of the urban and rural areas and the interrelationships between them. For instance, this incorporates variables such as, the willingness to pay for telephone services and the income per capita of the urban and rural population, and the population densities and operating costs of the telecom network, and relationships such as, the connecting rate of telephones is a function of the telephone capacity. Computer simulation performed through system dynamics allows inferring future long-term behavior, as a result of the dynamic interaction of the different elements of the regional telecom system. The future behavior could be exponential or linear growth, oscillation, S-shaped growth, overshoot and collapse, goal seeking, and growth with overshoot. Once the regional telecom system has been built, the physical variables and the actual relationships of the system facilitate the design of new policies for improving the behavior of the regional telecom system, such as improving the number of telephone lines in rural areas of developing countries. The chance of implementation of new telecom policies, which have been designed by

system dynamics modeling, is relatively high, since the policies consider the actual real variables of the regional telecom system.

As in every industry, telecommunications is composed of markets, organizations, regulations, resources, and technologies. The relationships between these entities is not static, there is a dynamic interaction which demands a dynamic analysis. The analysis of the interactions between different elements of the telecommunications industry can be appropriately done by the use of system dynamics. Jay Forrester in his book 'Industrial Dynamics' showed how different elements of an industry are modeled as a set of relationships and feedback loops. Jay Forrester also modeled the market growth in a particular industry. System dynamics has already been used for modeling the growth of the telecom market through establishing relationships between different sectors of the telecom industry such as, demand and supply (Jensen et. al., 2002; Lyons et. al., 1997; Bui and Loebbecke, 1996; Ramos and Gerstenfeld, 2004; Dutta and Roy, 2003).

The study of policy issues and regulatory aspects of telecommunications is suitable to the use of system dynamics. System dynamics deals with the limitation of bounded rationality or a linear cause-and-effect relationship commonly applied in policy or strategy design and considers the main interactions between the different elements of the telecom market. For this reason, SD has been widely used in the design of policies and strategies in several fields. In fact, several papers and books have been written where system dynamics has been used as the methodology for modeling policies and strategies of corporations and nations (Saeed, 1994; Lyneis, 1980). The design of

policies and strategies for the telecommunications industry through system dynamics has already started and is growing. For instance, it has been used to explore different pricing policies for telecom services (Zhang and Liang, 1998; Wang et. al., 2001) and to explore strategies for a competitive or liberalized telecom market (Brady, 1999). Finally, system dynamics is used in this dissertation, specifically for investigating the impact of Universal Service Obligations and International Cross-Subsidies on the growth of rural telecom infrastructure.



## **Chapter 4 Formulation of the Regional Telecommunications System**

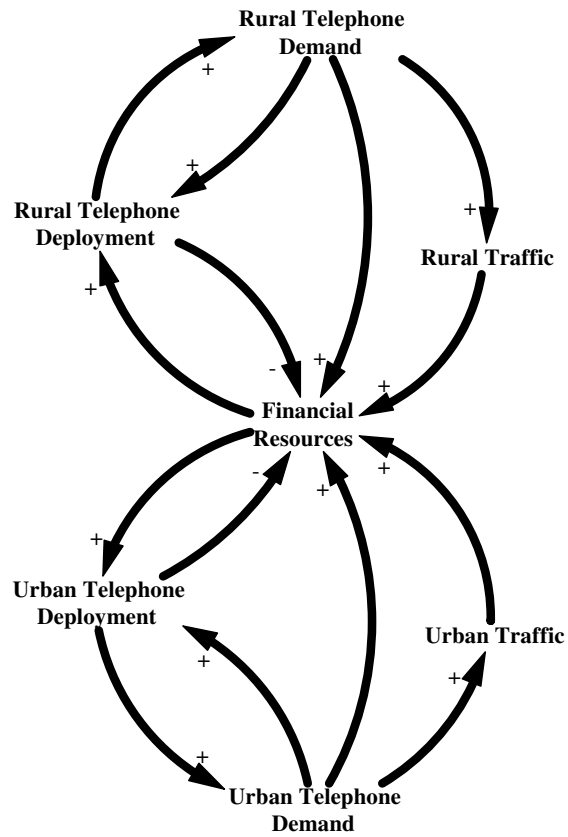
This model considers a case of government or privately owned telecom monopoly, whose tariffs are fixed and regulated by the government. The telecommunications in developing countries is still a monopoly in many senses, even when competition is introduced. The international experience has shown that the incumbent manages to retain its leadership position and market power long after liberalization (Makhaya and Roberts, 2003). Many countries implement this model in the public sector, but it is important to note that the implementation of Universal Service Obligations and International Cross-Subsidies also happens in privatized markets when mandated by telecom regulatory authorities.

The model is divided into 4 sectors: 1) Telephone Demand, 2) Telephone Deployment, 3) Telephone Traffic, and 4) Financial Resources. These sectors are replicated for two regions: urban and rural. At an aggregate level, the interactions between the sectors can be represented by the causal diagram in Figure 4.

Telephone Demand represents the subscribers with telephone lines and the unmet demand, which is composed of subscribers in the waiting list and potential subscribers willing to pay the monthly rental fee but not decided to pay the activation fee and the telephone device cost yet. The subscribers in the waiting list are connected at a rate, which depends on the new telephone capacity. Telephone Deployment represents the process of deployment of new telephone capacity, which is a function of the amount of economic resources available, the number of subscribers in the waiting list, the current number of new telephone lines ready to be connected, and the number

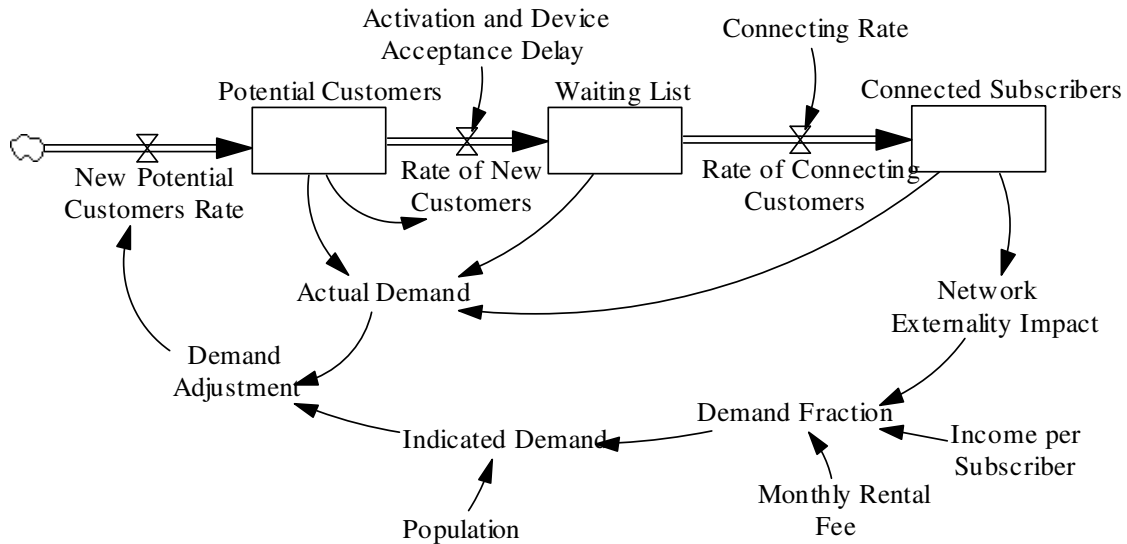
of telephone lines being deployed. Telephone Traffic represents the level of usage of the telephone network in urban and rural areas as a function of the price, income per capita of the population, and the current penetration of telephone lines in the region. Financial Resources accumulates the economic resources used in the expansion of telecom infrastructure in urban and rural areas. Financial Resources depends on the number of subscribers, the telephone traffic, the price of the service, the operating costs, and the amount of money invested in telecom infrastructure.

Each sector shown in Figure 4 represents the regional telecom system and is driven by decision rules created by its own working environment while also reacting to information and inputs received from other sectors. The structure of each sector and detailed mathematical relationships of the model are discussed below.



**Figure 4. A Simplified Sector Map of the Regional Telecom System.**

#### 4.1 Telephone Demand Sector



**Figure 5. Telephone Demand Sector**

The Telephone Demand sector shown in Figure 5 is represented as a supply chain, both in rural and urban regions, where the population is the source of potential customers; the potential customers become subscribers in the waiting list; and subscribers in the waiting list become connected customers.

The actual demand of telephone lines includes connected customers, customers in the waiting list, and potential customers. The population becomes potential consumers when the utility of the service is higher than its price. The price represents the monthly rental fee for the postpaid telephone service. The potential customers become customers in the waiting list after they are willing to pay for the activation charges and/or telephone devices (Warren, 2002). The customers in the waiting list become connected subscribers when they get connected, which depends on the connecting capacity of the telephone company (Jensen et. al., 2002). The connected

subscribers, therefore represent the part of the demand that can be served under the current conditions of supply (Ros and Banerjee, 2000). The connected subscribers create the revenue that feeds into the financial resources of the telephone company, as shown in Figure 5.

Potential new customers adjust towards an indicated demand for new lines, which is a function of the total population, the impact of telephone density as a network externality factor, the monthly rental fee, and the income per subscriber. In addition, it is assumed that the impact of telephone density on rural access demand is lower than the impact on urban areas, which is borne out by evidence concerning the income and preferences of the rural population in developing countries (Goussal and Udrizar, 2000; GAS 5, 1984; Wellenius, 2002).

The impact of the monthly rental fee on indicated demand is determined by the elasticity of the demand with respect to the monthly rental fee, which has been observed to be higher in rural areas than in urban areas, because of the lower income levels and perceived usefulness of the service (Cain and Macdonald, 1991).

#### **4.2 Equations of the Telephone Demand Sector**

It is assumed that the number of connected subscribers (CS) is increased by the connecting rate (CR) and decreased by the connected customers attrition rate (AR). The connecting rate (CR) is a function of the fraction of lines connected per month (FLC), the postpaid-prepaid waiting list fraction (PPWLF), and the telephone capacity (TC), which represents the telephone lines recently deployed and ready to be allocated to a

customer in the waiting list. In addition, the connected customers attrition rate (AR) is assumed a function of demand adjustment (DA), which represents the discrepancy between indicated demand (ID) and actual demand (AD). The actual demand (AD) adjusts towards the indicated demand (ID) value through an adjustment time (TAD). The demand adjustment (DA) can be positive or negative; when it is negative the attrition rate (AR) is higher than zero. Subscript  $i$  refers to any of the two sectors, urban (u) and rural (r), and superscript  $j$  to any type of telephone service, local (l), long distance (ld), and international (t):

$$(d / dt) CS_i = CR_i - AR_i \quad (1)$$

$$CR_i = TC_i * FLC_i * PPWLF_i$$

$$DA_i = (ID_i - AD_i) / TAD$$

$$AR_i = DA_i \quad (\text{If } ID_i < AD_i)$$

The postpaid waiting list (WL) is increased by the rate of new customers (RNC) and decreased by the connecting rate (CR). The rate of new customers (RNC) is a function of the number of potential customers who are willing to pay for the monthly rental fee, but not decided to pay for the activation fee and telephone device costs yet (PC), and the delay to accept the activation fee and telephone device costs (DAAF):

$$(d / dt) WL_i = RNC_i - CR_i \quad (2)$$

$$RNC_i = PC_i / DAAF_i$$

The potential customers (PC) are increased by the new potential customer rate (NPCR) and decreased by rate of new customers (RNC). The new potential customers rate (NPCR) is a function of demand adjustment (DA). When demand adjustment (DA) is positive the new potential customer rate (NPCR) is higher than zero:

$$(d / dt) PC_i = NPCR_i - RNC_i \quad (3)$$

$$NPCR_i = DA_i \quad (\text{If } ID_i > AD_i)$$

The indicated demand (ID) is a function of the population of telephone subscribers in the region (PTS) and the demand fraction (DF):

$$ID_i = PTS_i * DF_i \quad (4)$$

The actual demand (AD) is the sum of potential customers (PC), customers in the waiting list (WL), and connected subscribers (CS):

$$AD_i = PC_i + WL_i + CS_i \quad (5)$$

The demand fraction (DF) is a function of the effect of price on demand (EPD) and the effect of attractiveness on demand (EAD). The effect of price on demand (EPD) is equal to the monthly rental fee fraction (MRFF) and the effect of attractiveness on demand (EAD) is equal to the network externality impact (NEI):

$$DF_i = EPD_i * EAD_i \quad (6)$$

$$EPD_i = MRFF_i$$

$$EAD_i = NEI_i$$

The monthly rental fee fraction (MRFF) is a function of the discrepancy between actual monthly rental fee (MRF) and normal monthly rental fee (NMRF):

$$MRFF_i = f_{1i}(MRF_i / NMRF_i) \quad (7)$$

Where  $f'_{1i} < 0$

The network externality impact (NEI) is a function of the telephone density fraction (TDF). As it was explained before the impact of network externality on demand in urban areas is higher than the impact on the rural ones. This characteristic is represented by the nonlinear function  $f_2$ :

$$NEI_i = f_{2i}(TDF_i) \quad (8)$$

Where  $f'_{2i} > 0$

The telephone density fraction (TDF) is function of the urban and rural telephone density (TD), and the coefficients  $a_1$  and  $a_2$ . These coefficients determine the weight of urban and rural telephone density, respectively, on network externality. It is assumed that most of the value of the telephone network comes from the same regional network. For instance, in urban and rural areas more than 50% of the value comes from the urban and rural network respectively. It has been established that a high proportion of the rural traffic is sent to the urban network, which indicates that the rural population places a high value to the urban network (Kayani and Dymond, 1997).



In addition, it is also assumed that the urban population values less the size of the rural network than the rural population values the size of the urban network. It could be the case that the telephone density in rural areas is very low, but because the telephone density in urban areas is considerably higher than rural areas, the telephone demand in rural areas influenced by the telephone density in urban areas will not be very low, as it would be if the rural telephone density were the only factor influencing the rural demand. Finally it was assumed that coefficient  $a_1$  is 0.9 and 0.5 for urban and rural areas respectively, and coefficient  $a_2$  is 0.1 and 0.5 for urban and rural areas respectively:

$$TDF_i = TD_u * a_{1i} + TD_r * a_{2i} \quad (9)$$

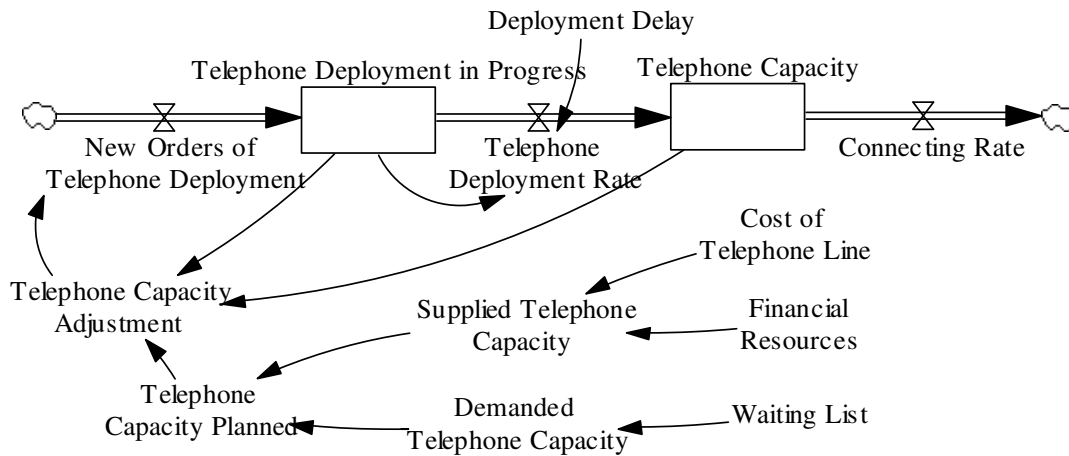
The urban and rural telephone density (TD) is the relationship between the total telephone subscribers (TTS) and the population of telephone subscribers (PTS):

$$TD_i = TTS_i / PTS_i \quad (10)$$

The total telephone subscribers (TTS) is the sum of postpaid connected subscribers (CS), prepaid telephone subscribers ( $VASU_i^{PP}$ ), and virtual telephony subscribers (VTS):

$$TTS_i = CS_i + VASU_i^{PP} + VTS_i \quad (11)$$

### 4.3 Telephone Deployment Sector



**Figure 6. Telephone Deployment Sector**

The telephone deployment process in both urban and rural regions is represented by a supply chain, shown in Figure 6. The new orders of telephone deployment depend on a decision making process which addresses the shortfall as well as the supply of new telephone connections; a decision rule widely used for managing supply chains (Lyneis, 1980).

As the deployment process involves a considerable delay, a stock of telephone deployment in progress is included in the supply chain. It is important to note that the telephone deployment delay varies between urban and rural regions, mainly due to the population density and the availability of human resources and complementary infrastructure (Clarkstone et. al., 1990; Wellenius, 2002; The International Telegraph and Telephone Consultative Committee of ITU, 1985). For this reason, the deployment delay in rural regions is generally higher than it is in urban areas.

The number of orders in the waiting list, which is a function of the connecting rate of telephone lines and the flow of potential customers interested in becoming new subscribers, determine the demanded telephone capacity (Jensen et. al., 2002). The financial resources available and the cost of a telephone line determine the supplied telephone capacity, which is often lower than the demanded one because of the lack of economic resources. Indeed, in the developing countries, the supply of telephone lines is usually lower than the demand (Ross and Banerjee, 2000). It is also important to note that the cost of deploying a telephone line in rural regions is generally higher than the cost in urban areas because of the lower population density and complementary infrastructure (Goldschmidt, 1987; Kayani and Dymond, 1997; Crandall and Waverman, 2000), which is factored in the model's cost structure.

The actual telephone capacity planned is a function of the supply and demand of telephone capacity. It is equal to the supplied telephone capacity if supply is lower than the demanded capacity. On the other hand, when the financial resources improve and the supply of telephone capacity becomes higher than the demanded capacity, the actual telephone capacity planned is equal to the demanded telephone capacity.

#### **4.4 Equations of the Telephone Deployment Sector**

The telephone capacity (TC) is increased by the telephone lines deployment rate (TDR), the postpaid telephone attrition rate (AR), and the prepaid phone attrition rate ( $AR_{VAS_i}^{PP}$ ), and decreased by the postpaid telephone connecting rate (CR), the prepaid phone connecting rate (PPCR), and the telephone discard rate (DR). The

telephone deployment rate (TDR) is a function of telephone deployment in progress (TDIP) and telephone deployment delay (TDD). The telephone discard rate (DR) is function of the average connection rate (ACR), the telephone capacity planned (TCPL), the current telephone capacity (TC), telephone deployment in progress (TDIP), and the delay to adjust telephone capacity (DAT):

$$(d/dt)TC_i = TDR_i + AR_i + ARVAS_i^{PP} - CR_i - PPCR_i - DR_i \quad (12)$$

$$TDR_i = TDIP_i / TDD_i$$

$$DR_i = ACR_i + (TC_i + TDIP_i - TCPL_i) / DAT_i$$

The telephone deployment in progress (TDIP) is increased by the new orders of telephone deployment (NOTD) and decreased by telephone deployment rate (TDR). The new orders of telephone deployment (NOTD) are function of the average connection rate (ACR), the telephone capacity planned (TCPL), the current telephone capacity (TC), telephone deployment in progress (TDIP), and the delay to adjust telephone capacity (DAT):

$$(d/dt)TDIP_i = NOTD_i - TDR_i \quad (13)$$

$$NOTD_i = ACR_i + (TCPL_i - TC_i - TDIP_i) / DAT_i$$

The average connection rate (ACR) is a first order exponential average of the connecting rate (CR). The averaging process uses the time constant  $T_1$ , where  $\mu^1$  is the first order exponential average:

$$ACR_i = \mu^1 [CR_i, T_1] \quad (14)$$

The telephone capacity planned (TCPL) is a function of the supplied telephone capacity (STC) and demanded telephone capacity (TCD):

$$TCPL_i = STC_i \text{ (If } TCD_i > STC_i) \quad (15)$$

$$TCPL_i = TCD_i \text{ (If } STC_i > TCD_i)$$

The demanded telephone capacity (TCD) is function of the number of postpaid subscribers in the waiting list (WL), the prepaid subscribers in the waiting list (PPWL), and the number of telephone lines per subscriber (LPS):

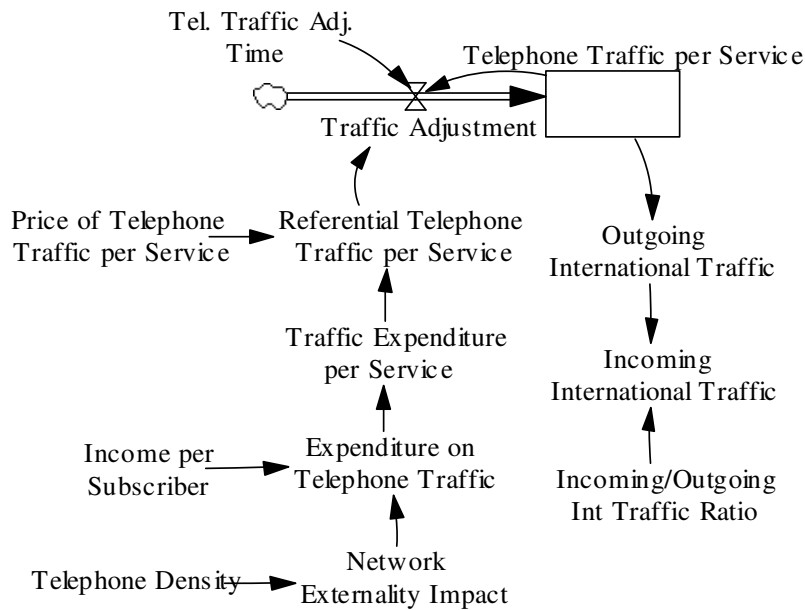
$$TCD_i = (WL_i + PPWL_i) * LPS \quad (16)$$

The supplied telephone capacity (STC) is function of the financial resources allocated for telephone investment (PTI) and the deployment cost of a telephone line (COT). The financial resources allocated for telephone investment (PTI) is a function of the telecom cash balance (TCB) and the telephone investment fraction per region (IFR):

$$STC_i = PTI_i / COT_i \quad (17)$$

$$PTI_i = TCB * IFR_i$$

## 4.5 Telephone Traffic Sector



**Figure 7. Telephone Traffic Sector**

This sector represented in Figure 7 assumes that the monthly rental fee of the postpaid telephone service includes free local minutes, and that rural subscribers enjoy rates that are lower than urban rates (Crandall and Waverman, 2000). The telephone traffic, both in urban and rural areas is a function of the income per subscriber (Kayani and Dymond, 1997). However, as previous research indicates, the traffic per person is lower in rural areas than in urban areas (Hudson, 1984; The International Telegraph and Telephone Consultative Committee of ITU, 1985; Wellenius, 2002).

Telephone density increases of telephone of calls made by the subscribers, and hence increases their expenditure on service (Shapiro and Varian, 1999). The higher the telephone density, the higher the expenditure on telephone services per line and also the

expenditure on telephone traffic. It is important to note that the increase of urban traffic is generally more sensitive to the increase of telephone density than the rural case.

The incoming international traffic per line generated overseas is also included in this sector, and is defined as a function of the outgoing international traffic per line and the incoming-outgoing imbalance of international traffic. It has been observed in several developing countries that the imbalance between incoming and outgoing international traffic has been able to generate more than fifty percent of the revenue of the telephone company via net settlements (Primo et. al., 1999).

#### **4.6 Equations of the Telephone Traffic Sector**

The telephone traffic per service (TTS) adjusts toward referential telephone traffic per service (RTTS) during a telephone traffic adjustment time (TTAT). The referential telephone traffic per service (RTTS) is function of the telephone traffic expenditure per service (TES), the price of telephone traffic per service (PRTS), and the free minutes consumed per service (FCS):

$$(d / dt) TTS_i^j = [RTTS_i^j - TTS_i^j] / TTAT \quad (18)$$

$$RTTS_i^j = (TES_i^j / PRTS_i^j) + FCS_i^j$$

The telephone traffic expenditure per service (TES) is a function of the expenditure on telephone traffic per subscriber (ETT) and the percentage of traffic expenditure per telephone service (PTES):

$$TES_i^j = ETT_i * PTES_i^j \quad (19)$$

The expenditure on telephone traffic per subscriber (ETT) is a function of the normal expenditure on telephone traffic (NETR) and the telecom expenditure increase fraction (TEI).

$$ETT_i = NETR_i * TEI_i \quad (20)$$

The telecom expenditure increase fraction (TEI) is equal to the telecom expenditure increase from size of the network fraction (TEISN) and telecom expenditure increase from mobility (TEIM):

$$TEI_i = TEISN_i * TEIM_i \quad (21)$$

The telecom expenditure increase from size of the network fraction (TEISN) is a non-linear function of the network externality impact (NEI):

$$TEISN_i = f_{3i}(NEI_i) \quad (22)$$

Where  $f'_{3i} > 0$

The telecom expenditure increase from mobility (TEIM) is a function of the number of mobile customers (MC) and the total telephone subscribers (TTS):

$$TEIM_i = f_{4i}(MC_i / TTS_i) \quad (23)$$

Where  $f'_{4i} > 0$



The normal expenditure on telephone traffic (NETR) is a function of the income per subscriber (IPS) and the fraction of the income per subscriber as expenditure on telephone traffic (FISETR):

$$\text{NETR}_i = \text{IPS}_i * \text{FISETR}_i \quad (24)$$

The willingness to pay for telephone services or subscriber expenditure on telecommunications (SET) is a function of the normal expenditure on telecommunications per subscriber (NETS) and the telecom expenditure increase fraction (TEI):

$$\text{SET}_i = \text{NETS}_i * \text{TEI}_i \quad (25)$$

The normal willingness to pay or expenditure on telecommunications (NETS) is function of the income per subscriber (IPS) and the fraction of the income per subscriber as expenditure on telecommunications (FISET):

$$\text{NETS}_i = \text{IPS}_i * \text{FISET}_i \quad (26)$$

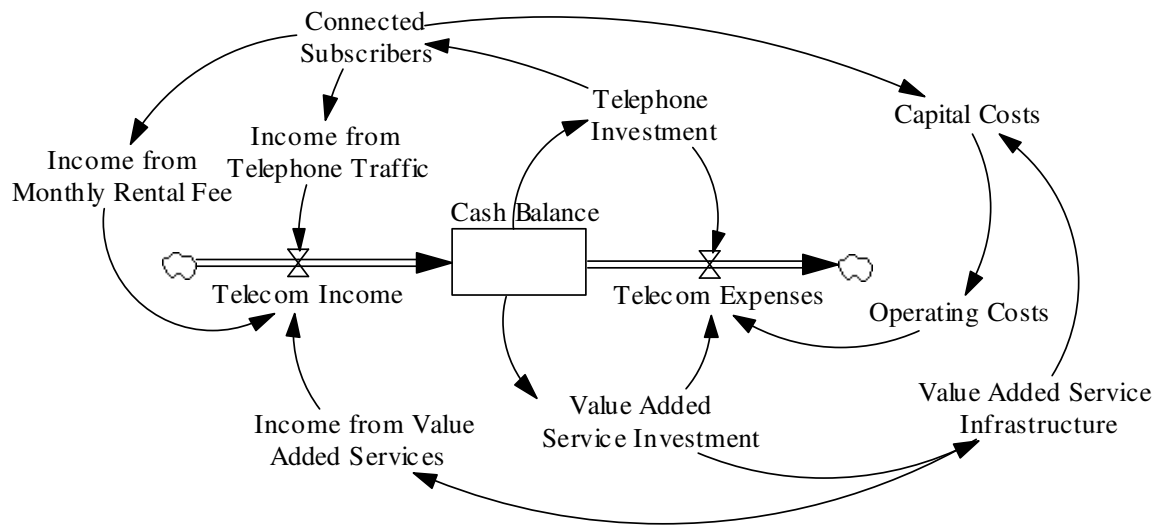
The incoming international traffic per line (IIT) is defined as a function of the outgoing international traffic per line ( $\text{TTS}_i^t$ ) and the incoming-outgoing international traffic ratio (IOIR):

$$\text{IIT}_i = \text{TTS}_i^t * \text{IOIR} \quad (27)$$

The normal monthly rental fee (NMRF) is function of the subscriber expenditure on telecommunications (SET) and the expenditure on traffic per subscriber (ETT):

$$\text{NMRF}_i = \text{SET}_i - \text{ETT}_i \quad (28)$$

#### 4.7 Financial Resources Sector



**Figure 8. Financial Resources Sector**

This sector represented in Figure 8, assumes that all revenue remains in the system. The cash balance is increased by income from the telephone and value added services and decreased by the operating costs and the amount of money invested in telephone expansion and value added service infrastructure.

The income from the postpaid telephone service includes net settlements received by the imbalance of outgoing and incoming international traffic with other countries, the income from national and international telephone traffic generated in

urban and rural regions, and the income from monthly rental fees. The income from national and international traffic depends on the connected subscribers in urban and rural areas, the telephone traffic per call, and the price of telephone traffic per call.

The operating cost is represented as a percentage of the capital costs. The world average was used in the model, which is about thirty percent of the capital costs (Kayani and Dymond, 1997). The profits of the telecom operation are accumulated in the cash balance, which are reinvested in telecom expansion (Hudson, 1984). It is also assumed that the telephone company invests a fraction of its the cash balance in expansion of telecom infrastructure in urban and rural areas.

#### **4.8 Equations of the Financial Resources Sector**

The telecom cash balance (TCB) is increased by the telecom income (TI) and decreased by the telecom expenses (TE) of the telephone company. The telecom income (TI) is function of the income from telephone traffic (ITR), net settlement (NS), activation income (AI), and the income from monthly rental fee (IMRF). The telecom expenses (TE) are function of the operating costs (OC), telephone investment (TINV), value added service investment (VSINV), and license expenses per month (LE). The superscript m refers to any type of value added service, payphone (php), virtual telephony (vtp), and prepaid phone (pp). The superscript n refers to any type of value added service infrastructure, mailboxes (mb), payphone devices (pphd), and calling card numbers (ccn):

$$(d / dt) TCB = TI - TE \quad (29)$$

$$TI = ITR + NS + AI + IMRF$$

$$TE = \sum_i (OC_i + TINV_i + VSINV_i) + LE$$

The income from telephone traffic (ITR) is the sum of the income from postpaid telephone traffic per service (I), which includes the income from local, long distance, and outgoing international traffic, and the income from different value added services (IVAS):

$$SI = \sum_j (I_u^j + I_r^j) + \sum_m (IVAS_u^m + IVAS_r^m) \quad (30)$$

The income from postpaid telephone traffic per service (I) is function of the telephone traffic per service (TTS), the free minutes granted per service (FS), the number of connected subscribers (CS), and the price of telephone traffic per service (PRTS):

$$I_i^j = (TTS_i^j - FS_i^j) * PRTS_i^j * CS_i \quad (31)$$

The income from value added services (IVAS) is a function of the number of VAS users (VASU) and the price of value added services (PVAS):

$$IVAS_i^m = VASU_i^m * PVAS_i^m \quad (32)$$

The net settlement (NS) is function of the number of postpaid connected subscribers (CS), the prepaid telephone subscribers ( $VASU_i^{pp}$ ), the imbalance of international traffic per subscriber per month (IIT), and the settlement rate (SR):

$$NS = \sum_i [(CS_i + VASU_i^{PP}) * IIT_i * SR] \quad (33)$$

The activation income (AI) is function of the connecting rate of postpaid customers (CR), the rate of connecting prepaid customers (PPCR), and the activation fee (AF):

$$AI = \sum_i [(CR_i + PPCR_i) * AF_i] \quad (34)$$

The income from monthly rental fee (IMRF) is function of the number of connected subscribers (CS) and the monthly rental fee (MRF):

$$IMRF = \sum_i (CS_i * MRF_i) \quad (35)$$

The operating costs (OC) are function of the capital costs (CCO), the percentage of capital costs as operating costs per year (PCIOC), and the monthly fraction of operating costs (MFOC):

$$OC_i = CCO_i * PCIOC_i * MFOC \quad (36)$$

The capital costs (CCO) is function of the telephone capital costs (TCCO) and value added services capital costs (VSCCO):

$$CCO_i = TCCO_i + VSCCO_i \quad (37)$$

The telephone capital costs (TCCO) is function of the number of postpaid connected subscribers (CS), prepaid telephone subscribers (PPTS), telephone capacity (TC), telephone deployment in progress (TDIP), and the cost of a telephone line (COT):

$$TCCO_i = (TS_i + PPTS_i + TC_i + TDIP_i) * COT_i \quad (38)$$

The value added service capital cost (VSCCO) is function of the amount of value added service infrastructure (VASI) and the cost of each VAS infrastructure (COVSI):

$$VSCCO_i = \sum_n (VASI_i^n * COVSI_i^n) \quad (39)$$

The value added service infrastructure (VASI) is function of the number of VAS users (VASU), the amount of VAS infrastructure per user (VASIPU), the payphone infrastructure installed (PAYII), and the payphone infrastructure being deployed (PAYDIP).

$$VASI_i^{ccn} = (VASU_i^{vtp} + VASU_i^{php} + VASU_i^{pp}) * VASIPU_i^{ccn} \quad (40)$$

$$VASI_i^{mb} = (VASU_i^{vtp}) * VASIPU_i^{mb}$$

$$VASI_i^{pphd} = PAYII_i + PAYDIP_i$$

The telephone investment (TINV) is function of the new orders of telephone deployment (NOTD) and the cost of a telephone line (COT):

$$TINV_i = NOTD_i * COT_i \quad (41)$$

The value added service investment (VSINV) is function of the new VAS infrastructure (NVASI) and the cost of each VAS infrastructure (COVSI):

$$VSINV_i = \sum_n (NVASI_i^n * COVSI_i^n) \quad (42)$$

#### 4.9 The Reference Mode of the Regional Telecom System

The reference mode generated by the base case simulation of the Regional Telecom System is observed in Figures 9, 10, and 11. Table 5 shows the base case values used to replicate the reference mode. The behavior observed in these figures is generated by the structure of the model described in this chapter, and represents the historical behavior described in chapter 2 over a period of nine years or 108 months. The base case values used to generate the reference mode are the following:

Model Parameters	Base Case
1. Monthly Rental Fee (Urban and Rural)	\$1
2. Urban Income per Capita	\$ 550
3. Rural Income per Capita	\$309
4. Total Connected Subscribers Initial	210,000
5. Percent. Rural Lines	2.5%
6. ITU Waiting List	50,000
7. Waiting List Unreported Factor	4
8. Initial Population	200,000,000
9. % Rural Population	60%
10. Urban Population Growth Rate	2.3%
11. Rural Population Growth Rate	0.2%

12. Urban Cost per Line	\$100
13. Rural Cost per Line	\$500
14. Telephone Deployment Time (Urban)	2 mo.
15. Telephone Deployment Time (Rural)	4 mo.
16. Number of Telephones per Urban House	1
17. Number of Telephones per Rural House	1
18. Initial Cash Balance	\$10 Millions
19. Investment in Rural Areas	3.5%
20. Delay to Accept Activation Fee	3 mo.
21. Wireless Flag (urban and rural)	0
22. License Cost	\$0
23. Activation Fee (Urban)	\$ 76
24. Activation Fee (Rural)	\$ 22
25. Price of International Traffic per Minute	\$ 1
26. Time to Recognize Attractiveness	6 mo.
27. Time to Adjust Demand (Urban and Rural)	60 mo.
28. Incoming-Outgoing International Traffic Ratio	3
29. Delay to Adjust Lines (Urban and Rural)	3 mo.
30. Initial Telephones to Connect (Urban)	10,000
31. Initial Telephones to Connect (Rural)	100
32. Regional Fraction Waiting List (Urban)	0.9
33. Regional Fraction Waiting List (Rural)	0.1
34. Fraction of Telephone Capacity per Month	0.25
35. Free Local Minutes (Urban and Rural)	100 min
36. Fraction of Cap Cost as part of Op. Cost	0.3
38. Urban Weight on Externality (Urban)	0.9
39. Urban Weight on Externality (Rural)	0.5
40. Rural Weight on Externality (Urban)	0.1
41. Rural Weight on Externality (Rural)	0.5
42. Free Local Minutes Used (Urban)	100



43. Free Local Minutes Used (Rural)	50
44. Expenditure on Traffic as Fr. of Income (Urb)	0.01
45. Expenditure on Traffic as Fr. of Income (Rur)	0.006
46. Fraction of Expenditure on Telecom (Urban)	0.015
47. Fraction of Expenditure on Telecom (Rural)	0.015
48. Number of People per House	4
49. Referential Price (Market Price Policy)	\$ 1

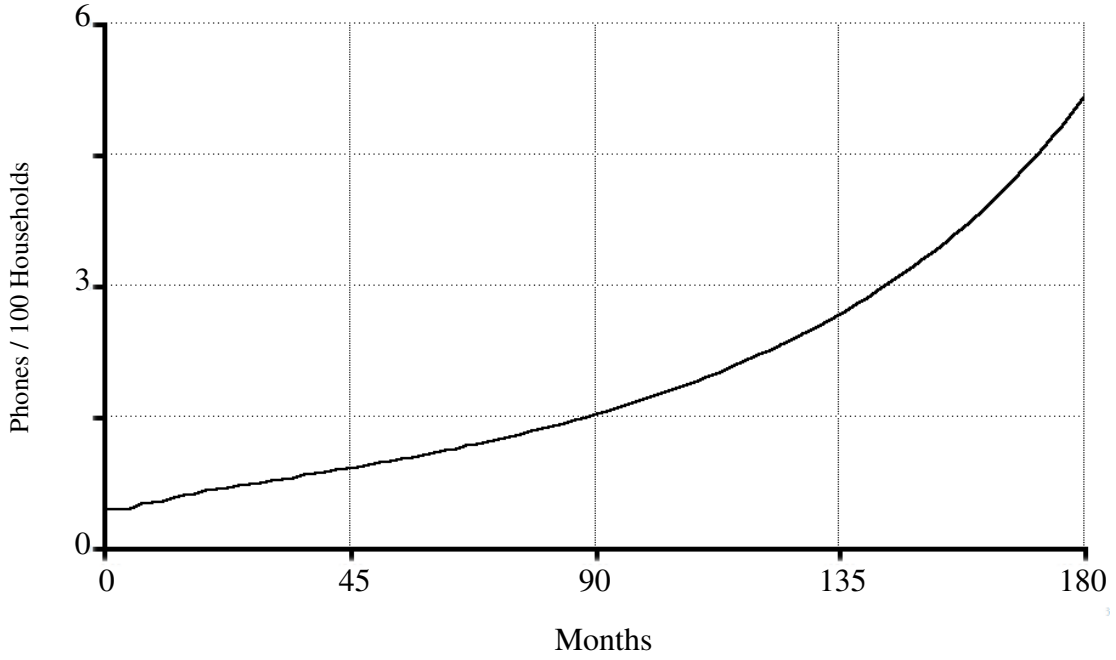
**Table 5. Base Case values used to generate the Reference Mode**

The Figure 9 shows the low levels and growth of telephones densities in developing countries, which are less than 6 phones per 100 households in the base case simulation. This figure indicates the telephone tendisity at the national level, which is obtained dividing the total number of telephone lines to the total number of households in the country. The low levels of income per capita observed in developing countries generate low levels of financial resources to the telephone company, which are used for telephone expansion, as shown in positive feedback loops 1 and 2 of Figure 14. This reduces the telephone density in urban and rural areas of developing countries.

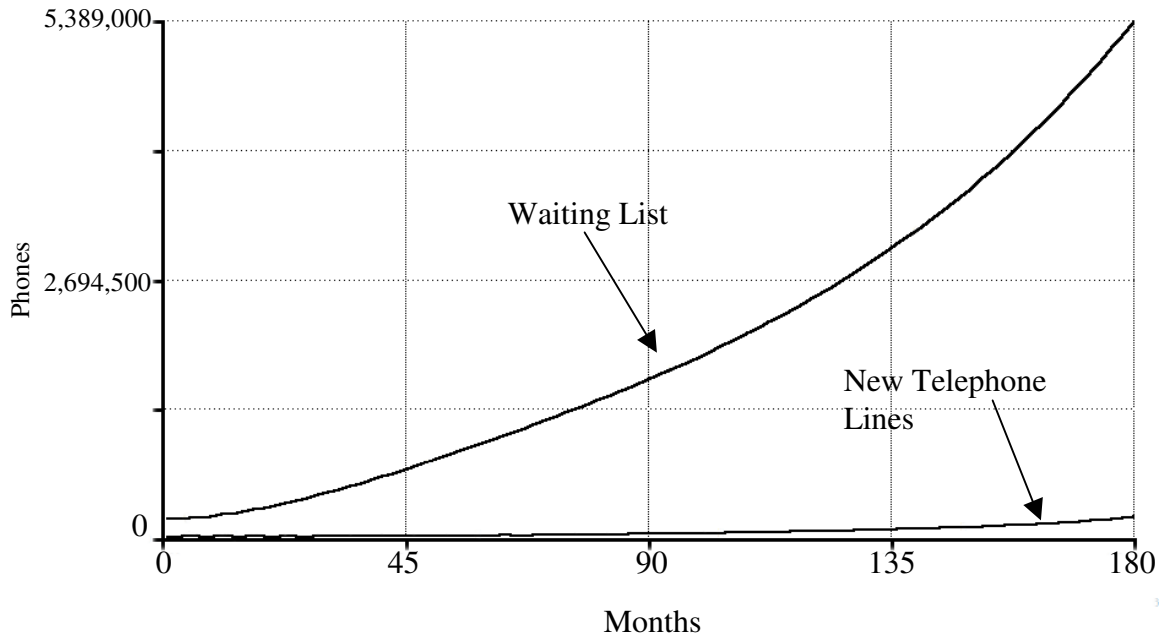
The Figure 10 shows the supply problem of telephone lines in developing countries, where the waiting lists of subscribers are higher than the new telephone lines available to connect. It can be seen that the gap between the waiting lists and the new telephones installed is increasing through time. This behavior indicates the lack of supply of new urban and rural telephone capacity because of the low levels of financial resources of the telephone company, which are used for telecom investment, as

observed in positive feedback loops 1, 2, 7, and 8 in Figure 14. In addition, the rate of new telephone subscribers in urban and rural areas depends on the monthly rental fee of the telephone service, as seen in positive feedback loops 3 and 4 of Figure 14. It has been observed in several developing countries that the urban monthly rental fees are lower than the willingness to pay of the population.

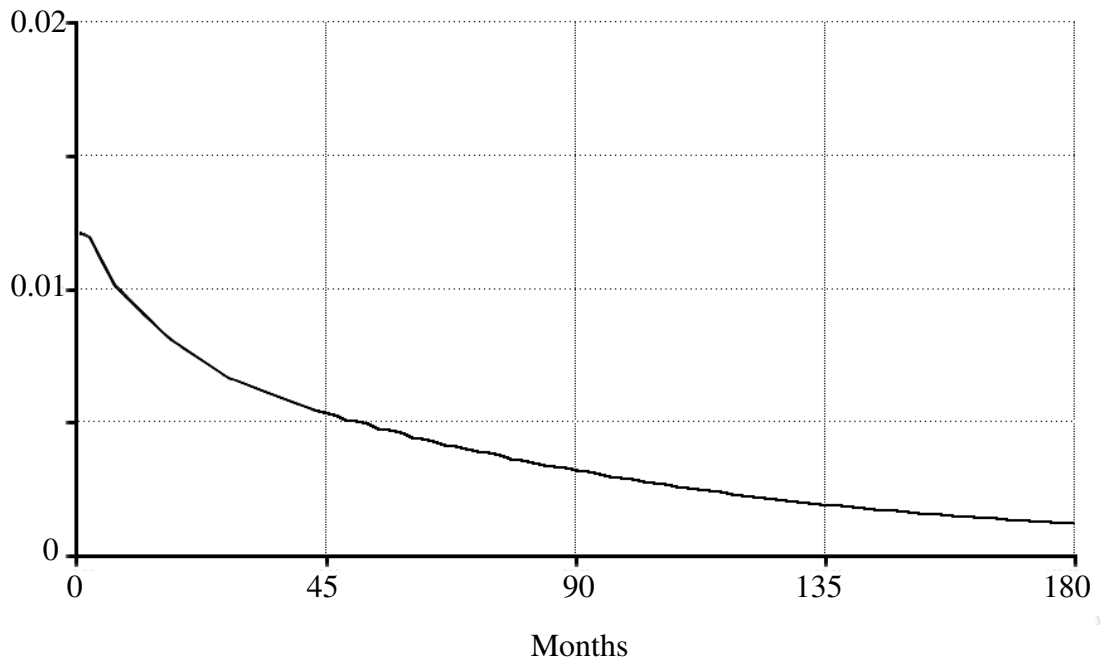
The gap in telephone penetration between rural and urban areas of developing countries is shown in Figure 11. This indicates the ratio between rural and urban telephone densities, which is very low. It can be observed that the urban telephone densities are higher than ten times the telephone densities in rural areas. Additionally, the ratio between rural and urban telephone densities is decreasing, which indicates that the regional telephone gap in developing countries is increasing. The lower income per capita of the rural population with respect to the urban population in developing countries, and the higher costs and obstacles experienced when deploying rural telecom infrastructure reduce even more the rural telephone densities with respect to the urban telephone densities, since they affect the positive feedback loops 2 and 8 in Figure 14.



**Fig. 9. National Telephone Density of the Reference Mode**



**Fig. 10. Waiting List vs. New Telephone Lines of the Reference Mode**



**Fig. 11. Rural-Urban Telephone Density Ratio of the Reference Mode**

## **Chapter 5. The Impact of Universal Service Obligations and International Cross-Subsidies on the Dispersion of Telephone Services in Developing Countries**

As it was earlier stated, the Universal Service Obligation and International Cross-Subsidy policies have not helped to increase the dispersion of telephone services into rural areas. Many experiments were performed with the model described in the previous chapter in order to see the impact of these policies on the growth of telephone services. It was simulated several Universal Service Obligation options, with different percentages of the total investment assigned to rural and urban regions, and several levels of International Cross-Subsidies implemented by below cost monthly rental fees.

The base case, with no subsidy policies in place replicates the reference mode, which is characterized by low levels and slow growth of rural and national telephone densities. This behavior is generated by the structure of the model described in chapter 4. It represents the historical behavior described in chapter 2 over a period of nine years or 108 months. The base case assumes a Rural Investment Fraction of 3.5 % and a monthly rental fee of one dollar.

### **5.1 The Impact of Implementing Universal Service Obligations**

This policy shown in Figures 12 and 13 is simulated by increasing the Rural Investment Fraction (RIF) from 3.5, which represents the base case, to 20 and 65 percent. This increase is made, even though the ratio of willingness to pay over operating costs is much higher in urban areas than in rural areas.

It is observed in Figures 12 and 13 that increasing the RIF from 3.5 % to 65 % reduces the national telephone density from the beginning and the rural telephone density in the very long run with respect to the base case. This happens because the increase in this obligation reduces the revenue from telecom services and the financial resources available for telecom investment. The decrease in financial resources not only reduces the urban telephone density; it also diminishes the telephone density in rural areas in the long run. The reduction of urban and rural telephone densities diminishes the overall telephone density of the country, as observed in Figure 13.

It is important to note that a Rural Investment Fraction of twenty percent also reduce the overall telephone density, but performs better in the long run than a Rural Investment Fraction of 65 %. In fact, the rural telephone density is improved and the urban and overall telephone densities are reduced again, with respect to the base case. The RIF of 20 % reduces less the urban and overall telephone densities than a RIF of 65 %. This happens because lower values of RIF are able to maintain the overall revenues at a higher level, which affects the rural telephone density in the long run. On the other hand, RIF values higher than sixty five percent produce a behavior similar to the sixty five percent case.

When the RIF is increased, the amount of money allocated for rural telecom investment is improved with respect to the base case in the short run, as indicated by feedback loop 2 of Figure 14. The increased investment in rural areas is achieved by reducing the portion of investment assigned to urban telecom capacity. The additional telecom investment assigned to rural areas turns into a lower number of new telephone

lines than the case when this extra amount of investment were assigned to the expansion of the urban telephone network. This happens due to the higher costs and deployment delays of the rural telephone lines with respect to the urban lines.

The improvement in the supply of new rural telephone lines increases the connecting rate of telephones in rural areas and the number of rural connected subscribers. The improved rural connecting rate tends to reduce the rural waiting list, as observed in negative feedback loop 6 in Figure 14. The additional rural connected subscribers improve the network externality impact in rural areas that enhances the rural demand for telephone access and the rate of new rural customers, which tend to increase the rural waiting list, as indicated by positive feedback loop 4.

The additional rural connected subscribers improve the rural traffic per line with respect to the base case because of the impact of the size of the network on traffic, as indicated by positive feedback loop 2 of Figure 14. The increase in rural connected subscribers and rural traffic per line improves the revenue of the telephone company from rural areas, as indicated by positive feedback loops 2 and 8 of Figure 14. However, the extra numbers of rural connected subscribers and rural traffic per line produced by the increase of the RIF, generate less revenue than if these extra numbers were in the urban network. This happens because the willingness to pay for telephone services in rural areas, which is a function of the income per capita, is lower than it is in urban areas.

The developing countries often have weak policy implementation institutions. This is a policy may often not be applied consistently and continuously. For this reason,

the increase of the Rural Investment Fraction only in the first four years is also shown in Figures 12 and 13. It is observed in Figure 12 that the rural telephone density is improved in the short run, but is reduced in the long term with respect to the base case. On the other hand, as observed in Figure 13, it reduces the national telephone density permanently. This happened because the increase of the RIF during the first four years of the simulation reduced the financial resources with respect to the base case, which turns into lower numbers of telephone lines and densities. The increase of the RIF during the first four years was able to improve the rural telephone density in the short term in spite of the reduction of financial resources, as seen in Figure 12.

## **5.2 The Impact of Implementing International Cross-Subsidies**

As described in chapter 2, the International Cross-Subsidy is implemented by having a below cost monthly rental fee in urban and rural areas and keeping the prices of international telecom traffic high and at above costs levels. In this case, the International Cross-Subsidy is implemented, even though the urban willingness to pay for telephone access is higher than the urban monthly rental fee and the demand for urban telephone access is relatively inelastic. The impact of this policy is shown in the normalized values observed in Policy 2 of Table 6. This shows that the ratio of urban operating cost to urban monthly rental fee and the ratio of urban access willingness to pay to urban monthly rental fee are higher than one, which indicates that the urban monthly rental fee is lower than the operating costs and the access willingness to pay in urban areas.

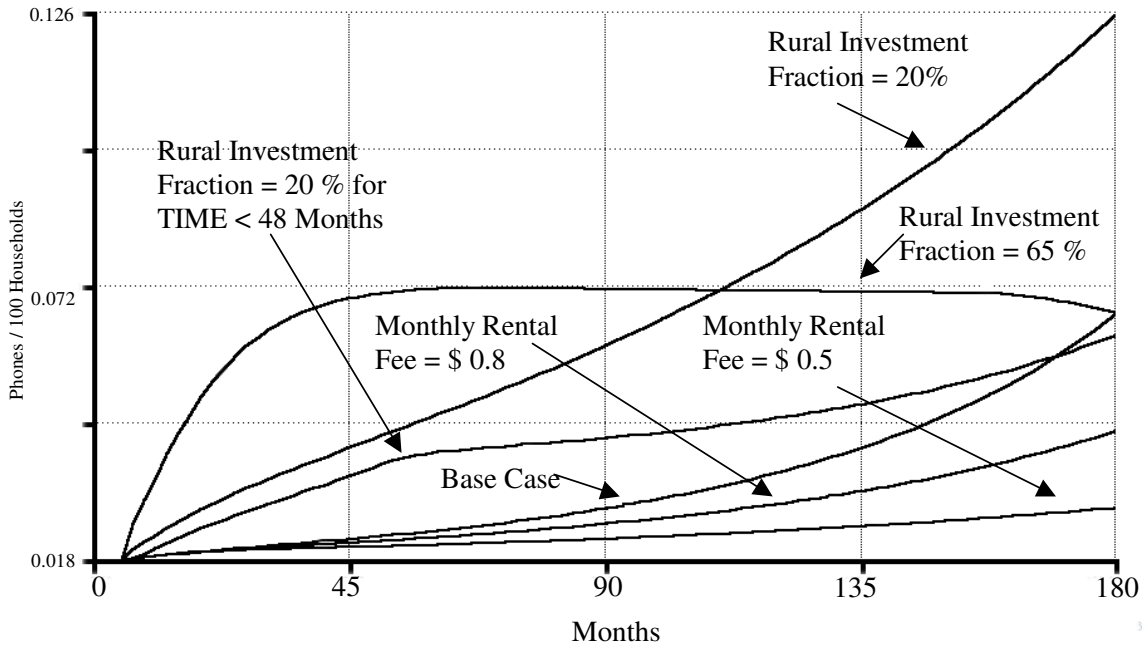


The performance of the International Cross-Subsidy is shown in Figures 12 and 13. It can be observed in Figure 12 that reducing the urban and rural monthly rental fee from one to 0.8 and 0.5 dollars reduces the rural telephone density with respect to the base case. This happens because the reduction of the urban monthly rental fee diminishes the revenue and the financial resources of the telephone company, which are used for investment in rural telecom capacity. In addition, the reduction of financial resources also diminishes the urban telecom investment, which reduces the supply of new urban telephone lines and the urban telephone density, as seen in Table 6. The reduction of rural and urban telephone densities reduces the overall telephone density of the country with respect to the base case, as shown in Figure 13. Finally, the higher the reduction of the urban monthly rental fee, the higher is the decrease of the financial resources of the telephone company and of the rural and overall telephone densities. Therefore, a urban monthly rental fee of 0.5 dollars will reduce more the financial resources, telephone investment, and telephone densities than a monthly rental fee of 0.8 dollars, as shown in Figures 12 and 13.

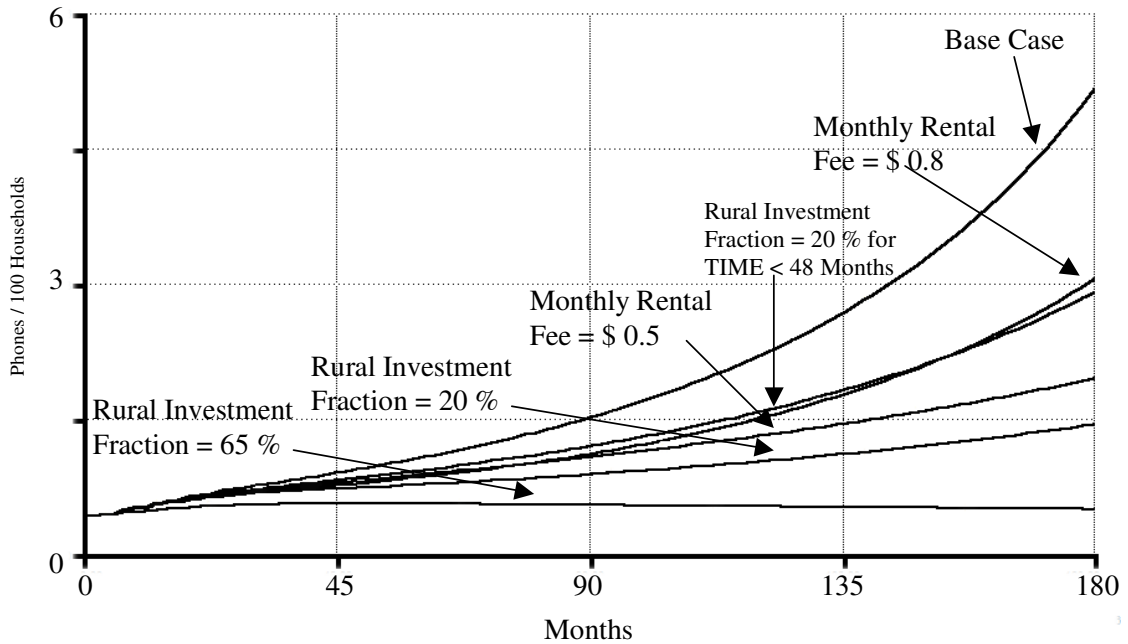
When the urban monthly rental fee is reduced, it increases the ratio of urban operating cost to urban monthly rental fee as well as the ratio of urban access willingness to pay to urban monthly rental fee with respect to the base case (observed in Policy 2 of Table 6). It can be seen that the normalized values of these ratios are equal to 2 at time zero, which indicates that the application of this international cross-subsidy has doubled the ratio of urban operating cost to urban monthly rental fee and the ratio of urban access willingness to pay to urban monthly rental fee, with respect to the base

case. This situation determines an increase in the level of international cross-subsidization, where the telephone company becomes more dependent on above cost international traffic and revenue. The decrease of the urban monthly rental fee diminishes the revenue and the financial resources of the telephone company, which reduces the gain of the positive feedback loop 7 in Figure 14. This situation diminishes the urban telephone investment, the supply of new urban telephone lines, and the number of urban telephone subscribers, which reduces again the revenue and financial resources of the telephone company, as observed in positive feedback loops 1 and 7.

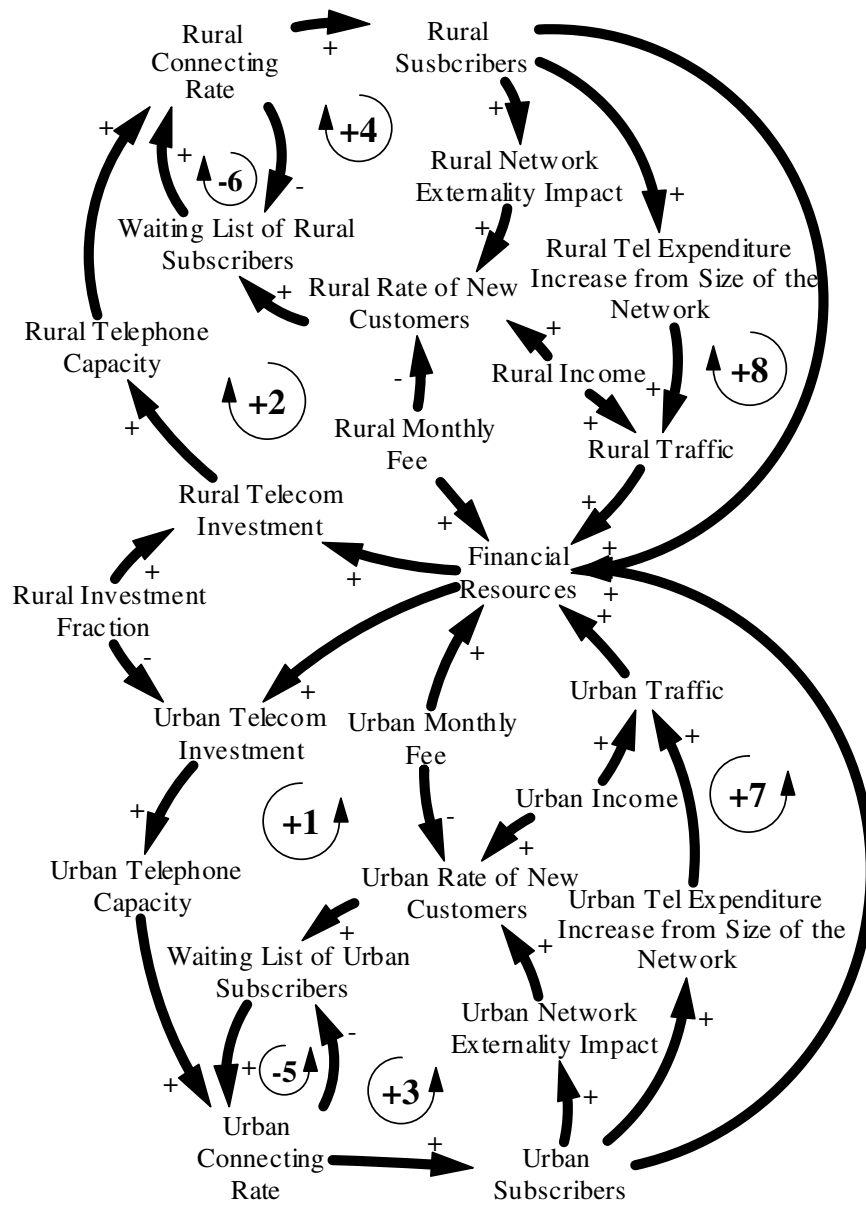
The diminution of financial resources also decreases the gain of positive feedback loops 2 and 8, which diminishes the rural telephone investment, the supply of new rural telephone lines, the connecting rate of rural telephone lines, and the number of rural telephone subscribers, which also decrease the revenue and financial resources of the telecom company, with respect to the base case.



**Figure 12. Rural Telephone Density for USO and International Cross-Subsidy Policies**



**Figure 13. National Telephone Density for USO and International Cross-Subsidy Policies**



**Figure 14. Causal Structure of Demand and Supply of the Regional Telecom System**

### **5.3 Policies for Improving Telephone Penetration.**

Several experiments were conducted with different pricing mechanisms and Universal Service Obligations policies, the following results summarize the best policies that considerably improved the regional dispersion of telephones in developing countries. Table 6 summarizes the performance of Universal Service Obligations, International Cross-Subsidies, Market-Clearing Pricing, and a combination of Market-Clearing Pricing with Universal Service Obligations.

#### **5.3.1 Market-Clearing Pricing**

This policy is implemented by defining the urban monthly rental fee as a function of the supply of additional urban telephone capacity, which depends on the financial resources, and demand for urban telephone capacity, which is a function of the urban waiting list of telephone subscribers. Figure 15 shows the behavior of the urban monthly rental fee when the market pricing mechanism is applied. The base case represents the behavior of a regulated and fixed monthly fee of one dollar. Figure 16 shows the feedback structure driving changes in monthly rental fee.

Whenever the market pricing mechanism is applied to urban areas, the urban monthly rental fee is increased when the ratio between the supplied urban telephone capacity and the demanded urban telephone capacity is lower than one. When supply of additional urban lines equals the demand for them, the monthly rental fee is assumed to be equal to a reference price of one dollar. When the financial resources are large enough, such that the supplied urban telephone capacity could be higher than the

demanded urban telephone capacity, the lower the urban monthly rental fee is, as indicated in the structure shown in Figure 16.

It is observed in Figure 16 that the increase of the urban monthly rental fee will tend to reduce the growth of urban potential telephone subscribers and improve the financial resources of the telephone company. The diminution of urban potential telephone subscribers decreases the gain of positive feedback loop 11, which reduces the urban waiting list and the demanded urban telephone capacity. On the other hand, the improvement in the financial resources increases the supply of urban telephone capacity. The augment of the supply of urban telephone capacity and the reduction of the demanded urban telephone capacity decrease the urban monthly rental fee in the long run, as observed in Figure 15. This improves the number of urban potential subscribers, the urban waiting list, and the demanded telephone capacity in urban areas also in the long run, as indicated by positive feedback loop 11 in Figure 16. This situation considerably increased the urban telephone density, the rural telephone density, the national telephone density, and the financial resources of the telephone company, as observed in the normalized values of Policy 3 in Table 6.

It is observed in Policy 3 of Table 6 that the increase of the urban monthly rental fee through market pricing considerably improves the financial resources and the telephone densities of the telephone company with respect to the base case. For instance at year 15, the national telephone density was increased from its normal value of 12.32 (Base Case) to 44.31 (Policy 3), and the financial resources were increased from 3.86 (Base Case) to 63.40 (Policy 3). The increase of the monthly rental fee in urban areas

has little effect on urban access demand, since this is relatively inelastic and the willingness to pay for urban telephone access is higher than the urban monthly rental access fee, as observed in Table 6.

The base case shows that the ratio of urban access willingness to pay to urban monthly rental fee is higher than 1. When the market pricing policy is applied to urban areas, it increases the urban monthly rental fee, which reduces this ratio in the short term and enlarges the financial resources and telephone densities of the telecom company. The growth of telephone densities enhances the network externality impact, which improves the willingness to pay for telephone access in urban areas. The improvement of the urban access willingness to pay and the reduction of the urban monthly rental fee in the long run, improve the ratio of urban access willingness to pay to urban monthly rental fee also in the long run, as observed in the normalized values of Policy 3 in Table 6.

### **5.3.2 Market-Clearing Pricing with Universal Service Obligation.**

This policy considers the market-clearing pricing policy described in the previous section, combined with an implementation of USO, which increases the RIF only after the urban telephone density reaches thirty percent. This means that thirty over 100 households have a telephone line. This level of connectivity occurs when the supply of telephone capacity in urban areas equals the demanded urban telephone capacity using a market-clearing pricing mechanism.

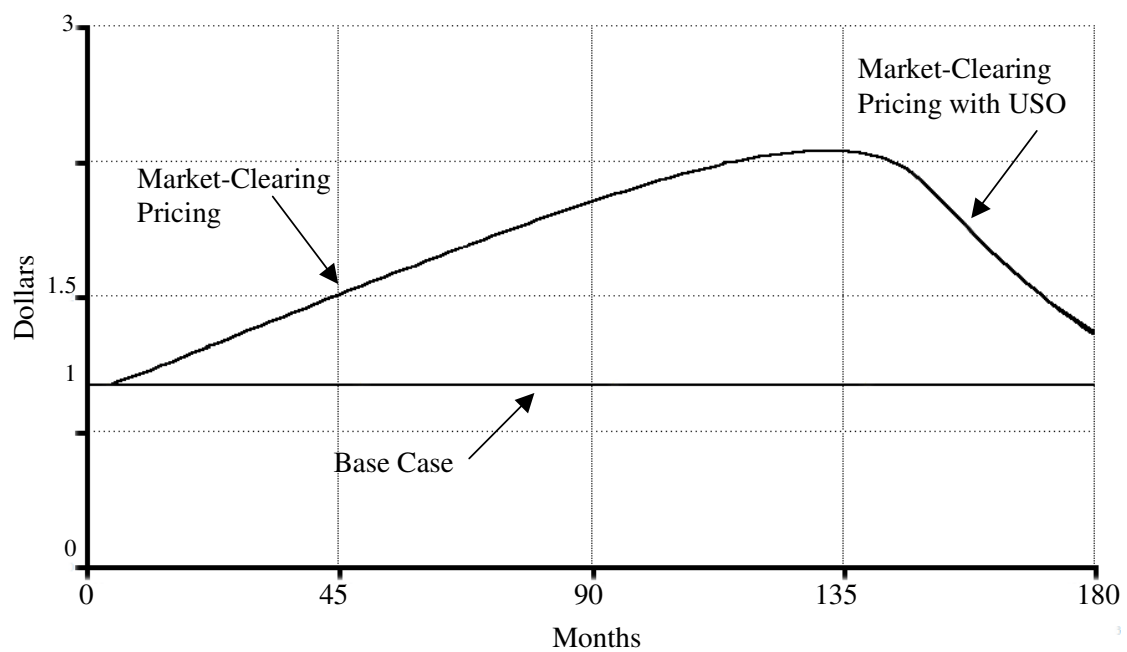
The addition of this particular implementation of USO to the market-clearing policy improves considerably the rural telephone density and the rural-urban telephone density gap in the long term with respect to the implementation of market-clearing pricing alone, without reducing the number of urban telephone lines and urban telephone density, as shown in the normalized values of Policies 3 and 4 in Table 6. The rural telephone density was improved from its normalized value of 19.72 (Policy 3) to 57.56 (Policy 4) in year 15, and the rural-urban telephone density gap was improved from 0.53 (Policy 3) to 1.53 (Policy 4) also in year 15. In fact, it slightly improves the national telephone density in the long run.

After the urban supply of telephone capacity equals the urban telephone demand when the market-clearing pricing is applied to urban areas, the financial resources considerably improve because the number of urban telephone lines has been increased by the action of positive feedback loops 1 and 7 in Figure 14, and the urban waiting list has been reduced by the action of negative feedback loop 10 in Figure 16.

The improvement of the financial resources to a level where the supply of urban telephone capacity equals the demanded urban telephone capacity reduces the strength of negative feedback loops 9 and 10 in Figure 16. The excess of financial resources can now be used to satisfy the rural waiting list by increasing the RIF, which improves the rural telecom investment and rural telephone lines and density. This situation raises the gain of positive feedback loops 2 and 8 in Figure 14, which increases the rural connecting rate and the gain of negative feedback loop 6, reducing the rural waiting list at the same time. However, the improvement of rural investment in the long term



diminishes the financial resources with respect to application of market-clearing pricing alone. This can be observed in the normalized values of financial resources corresponding to Policies 3 and 4 in Table 6. The financial resources are reduced from 63.40 (Policy 3) when the market price is implemented alone to 41.27 (Policy 4) when market pricing is combined with the increasing of the rural investment fraction when the telephone density reaches thirty percent.



**Figure 15. Market and Fixed Monthly Rental Prices**

Policy	Telecom Indicators	Years			
		0	0 (N)	9	15
Base Run	Rural Tel. Density	0.02	1.00	1.78	3.67
	Urban Tel. Density	1.02	1.00	4.11	10.54
	National Tel. Density	0.42	1.00	4.51	12.32
	Rural/Urban T D Gap	0.02	1.00	0.41	0.35
	Op. Cost / M. R. Fee (Urb)	2.50	1.00	1.00	1.00
	Access W.t.P / M. R. Fee (Urb)	1.00	1.00	1.10	1.40
	W.t.P / Op. Cost (Urb)	1.12	1.00	1.07	1.39
	W.t.P / Op. Cost (Rur)	0.12	1.00	1.00	1.02
	Financial Resources (Mill)	10.00	1.00	0.95	3.86
1. Universal Service Obligation RIF = 25 %	Rural Tel. Density		1.00	4.17	6.72
	Urban Tel. Density		1.00	2.27	2.99
	National Tel. Density		1.00	2.56	3.62
	Rural/Urban T D Gap		1.00	1.88	2.35
	Op. Cost / M. R. Fee (Urb)		1.00	1.00	1.00
	Access W.t.P / M. R. Fee (Urb)		1.00	1.10	1.40
	W.t.P / Op. Cost (Urb)		1.00	1.02	1.04
	W.t.P / Op. Cost (Rur)		1.00	1.00	1.00
	Financial Resources		1.00	0.27	0.41
2. International Cross-Subsidy M. Fee = \$ 0.5	Rural Tel. Density		1.00	1.17	1.28
	Urban Tel. Density		1.00	1.63	1.87
	National Tel. Density		1.00	1.79	2.20
	Rural/Urban T D Gap		1.00	0.71	0.71
	Op. Cost / M. R. Fee (Urb)		2.00	2.00	2.00
	Access W.t.P / M. R. Fee (Urb)		2.00	2.02	2.03
	W.t.P / Op. Cost (Urb)		1.00	1.01	1.02
	W.t.P / Op. Cost (Rur)		1.00	1.00	1.00
	Financial Resources		1.00	0.09	0.15
3. Market-Clearing Pricing	Rural Tel. Density		1.00	2.50	19.72
	Urban Tel. Density		1.00	7.00	37.76
	National Tel. Density		1.00	7.67	44.31
	Rural/Urban T D Gap		1.00	0.35	0.53
	Op. Cost / M. R. Fee (Urb)		1.00	0.46	0.80
	Access W.t.P / M. R. Fee (Urb)		1.00	0.53	1.50
	W.t.P / Op. Cost (Urb)		1.00	1.17	1.93
	W.t.P / Op. Cost (Rur)		1.00	1.01	1.08
	Financial Resources		1.00	3.29	63.40
4. Market-Clearing Pricing with USO RIF = 45 %	Rural Tel. Density		1.00	2.50	57.56
	Urban Tel. Density		1.00	7.00	37.76
	National Tel. Density		1.00	7.67	45.14
	Rural/Urban T D Gap		1.00	0.35	1.53
	Op. Cost / M. R. Fee (Urb)		1.00	0.46	0.76
	Access W.t.P / M. R. Fee (Urb)		1.00	0.53	1.48
	W.t.P / Op. Cost (Urb)		1.00	1.17	1.93
	W.t.P / Op. Cost (Rur)		1.00	1.01	1.08
	Financial Resources		1.00	3.29	41.27

Table 6. Performance of Different Telecom Policies in Developing Countries

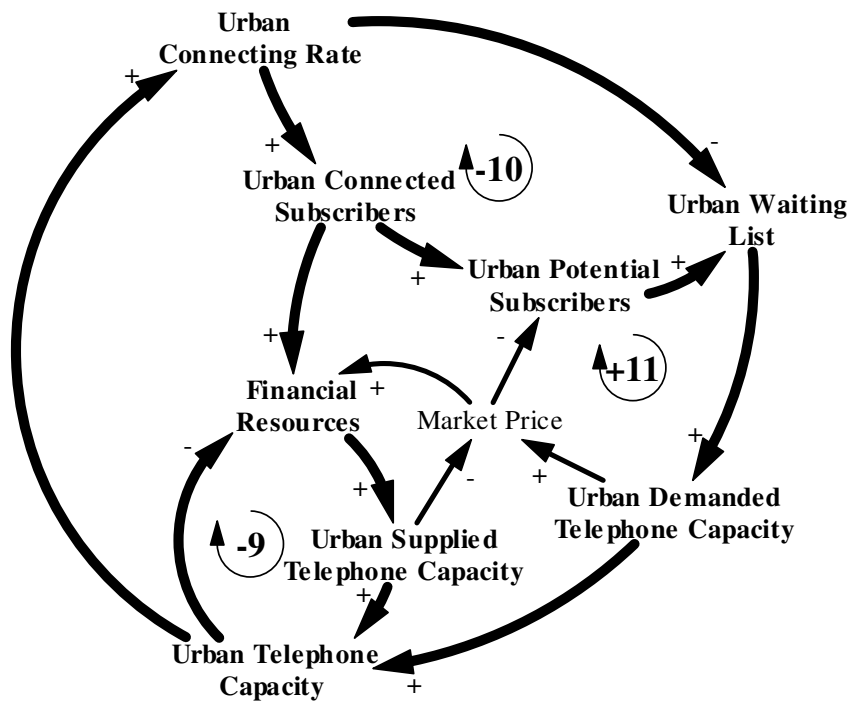


Figure 16. Feedback Loops affecting Urban Telephone Capacity

### 5.3.3 Formulation of Market-Clearing Pricing

The market-clearing pricing mechanism (MCP) adjusts this price towards an indicated monthly rental fee (IMRF), which is a function of the current monthly rental fee (MRF) and a non-linear function of the ratio between the supplied telephone capacity (STC) and the demanded telephone capacity (TCD). The time to adjust market price (TAP) depends on this non-linear function and a referential time to adjust market price (RTAP):

$$(d / dt)MCP_u = (IMRF - MCP_u) / TAP_i \quad (43)$$

$$IMRF = MRF * f_4 (STC_i / TCD_i)$$

$$TAP_i = RTAP * (1 + f_4 (STC_i / TCD_i)), \quad \text{Where } f_5 \text{ is } < 0$$

### 5.3.4 Sensitivity of Policies for Improving Rural Telecommunications

An important instrument in the policy framework outlined in the preceding section is the application of market-clearing pricing to urban areas, which improves the revenue and the financial resources of the telecom company reducing the urban unmet demand at the same time. In addition, the market-clearing pricing combined with an implementation of USO was able to improve the rural telephone density without diminishing the urban telephone density.

New experiments were conducted to test the sensitivity of market-clearing pricing combined with USO, to changes in the urban income per capita, cost of providing service, deployment time of telephone lines, and the network externality impact. The network externality impact is a non-linear function of the telephone density, which improves the attractiveness and demand of the telephone service and the expenditure on telephone traffic, as the telephone density increases. The urban income per capita, deployment time and cost of telephone lines were increased, and the network externality impact was reduced (the slopes of the curves that define this impact in urban and rural areas, which are shown in the appendix, were reduced).

The urban income per capita was increased from 550 dollars to 1,500 dollars, the deployment time was increased from two to four months in urban areas and from four to six months in rural areas, the cost of a telephone line was increased from 100 to 150

dollars in urban areas and from 500 to 700 dollars in rural areas. The simulation results of this sensitivity analysis are summarized in the normalized values of Table 7.

It is observed in Table 7 that the application of market-clearing pricing to urban areas, shown in Policy 1, still improves both the urban and rural telephone densities with respect to the base case. It can be seen in year 15, that the rural telephone density is increased from its normalized value of 18.22 (Base Case) to 40.28 (Policy 1), and the urban telephone density is increased from its normalized value of 36.88 (Base Case) to 40.39 (Policy 1), when market pricing is applied. The market-clearing pricing mechanism initially increases the urban monthly rental fee and later reduces it. This improves the financial resources and the number of telephone lines, and reduces the unmet demand.

The implementation of market-clearing pricing combined with the implementation of USO when the urban telephone density reaches thirty five percent is shown in Policy 2. This appears to considerably increase the rural telephone density and the rural-urban telephone density gap in the long term compared with the application of market-clearing pricing alone. It is observed in the normalized values of Policies 1 and 2 in year 15 that the rural telephone density is increased from 40.28 (Policy 1) to 161.33 (Policy 2), and the rural-urban telephone density gap is improved from 1 (Policy 1) to 4.12 (Policy 2). When market pricing is combined with USO, the financial resources are reduced with respect to the application of market pricing alone. It can be seen in Table 7 that the normalized values of financial resources are reduced from 244.20 (Policy 1) to 130.20 (Policy 2).

Policy	Telecom Indicators	Years			
		0	0 (N)	9	15
Base Run	Rural Tel. Density	0.02	1.00	2.83	18.22
	Urban Tel. Density	1.02	1.00	7.39	36.88
	National Tel. Density	0.42	1.00	8.10	43.24
	Rural/Urban T D Gap	0.02	1.00	0.35	0.47
	Op. Cost / M. R. Fee (Urb)	3.75	1.00	1.00	1.00
	Access W.t.P / M. R. Fee (Urb)	7.63	1.00	1.18	1.78
	W.t.P / Op. Cost (Urb)	2.03	1.00	1.18	1.78
	W.t.P / Op. Cost (Rur)	0.11	1.00	1.02	1.06
	Financial Resources (Mill)	10.00	1.00	6.19	141.60
1. Market-Clearing Pricing	Rural Tel. Density		1.00	3.28	40.28
	Urban Tel. Density		1.00	8.98	40.39
	National Tel. Density		1.00	9.83	47.81
	Rural/Urban T D Gap		1.00	0.35	1.00
	Op. Cost / M. R. Fee (Urb)		1.00	0.47	0.80
	Access W.t.P / M. R. Fee (Urb)		1.00	0.58	1.55
	W.t.P / Op. Cost (Urb)		1.00	1.26	1.80
	W.t.P / Op. Cost (Rur)		1.00	1.02	1.07
	Financial Resources (Mill)		1.00	9.26	244.20
2. Market-Clearing Pricing with USO RIF = 45 %	Rural Tel. Density		1.00	3.28	161.33
	Urban Tel. Density		1.00	8.98	40.39
	National Tel. Density		1.00	9.83	50.52
	Rural/Urban T D Gap		1.00	0.35	4.12
	Op. Cost / M. R. Fee (Urb)		1.00	0.47	0.87
	Access W.t.P / M. R. Fee (Urb)		1.00	0.58	1.55
	W.t.P / Op. Cost (Urb)		1.00	1.26	1.80
	W.t.P / Op. Cost (Rur)		1.00	1.02	1.07
	Financial Resources (Mill)		1.00	9.26	130.20

**Table 7. Performance of Market-Clearing Pricing Policies for Higher Income per Capita, Implementation Costs and Deployment Times, and Lower Network Externality Impact.**

### 5.3.5 Conclusions

Governments and international organizations often attempt to achieve the universal service and increase the rural telecom infrastructure in developing countries by implementing Universal Service Obligations and International Cross-Subsidies. These organizations, however, do not have a clear understanding of the implications and

impacts of such policies. The Universal Service Obligation policy increases the percentage of investment in rural areas, while reducing the percentage in urban areas. The International Cross-Subsidy policy maintains the international service prices high while keeping the urban monthly rental fee below the urban operating cost and urban willingness to pay for telephone access values. We found that these policies are counterproductive because of they limit growth in service due to financial constraints they create.

The simulations showed that market-clearing pricing applied to urban areas was able to considerably improve the number of rural and urban telephone lines and the financial resources of the telecom company. However, if the Universal Service Obligation policy is implemented simultaneously after the urban telephone density reaches thirty percent, while the supply of urban telephone capacity equals the demanded capacity, a considerable increase of rural telephone density is obtained.

The findings of this research are useful for telecom operators and regulators, since they can identify the pervasive impact of cross-subsidies on the dispersion of telephone services. However, the actual implementation of these policies and strategies in real life requires the model to be constantly updated to capture changes in telecom policies and technologies.

More research under new and different scenarios is needed in order to identify new strategies and policies that could increase telephone dispersion in developing countries. The investigation of new pricing mechanisms and service combinations that could improve telephone penetration in developing countries will be of value. The

impact of competition and quality of service are other important issues that can be addressed by extending the model presented in this dissertation.



## **Chapter 6. A Value Added Service Strategy for the Improvement of Telephone Density in Rural Areas of Developing Countries.**

### **6.1 Abstract**

Telephone densities in developing countries are typically extremely low. This is often a consequence of poor planning and inadequate pricing policies. The regional telecom model is extended to deal with the complexity of the telecommunication system in a developing country, giving special attention to the discrepancies between urban and rural areas. This model is used to test several combinations of service offerings and pricing policies that exploit positive feedback loops of the telecom system. Simulations suggest that the dispersion of telephone services in rural areas may significantly improve when a prepaid pricing scheme is applied simultaneously to the telephone, virtual telephony, and the payphone services. Other schemes are also tested but fail to bring significant improvements to the underdeveloped telecommunication system.

### **6.2 Introduction**

The current policies and technologies for increasing telecommunications deployment in rural areas are considered to be insufficient or unsuccessful, and the plans for expansion of local telephone networks are considered to be imprecise considering the scope of the investment (Malecki, 2003; Melody, 1999; Strover, 2003; Calhoun, 1992). However, the value added services (VAS) are considered to have the potential to increase the telephone access in developing countries, but it is still not clear

if they will be able to improve the telephone density in unprofitable rural areas and reduce the rural-urban telephone density gap after their implementation.

In some cases, the low level of telephone penetration in developing countries has been attributed to an outdated telecommunications system that prevents development of value added services, which are supposedly able to generate more revenue required for telecom investment (Fretes-Cibils et. al., 2003). In some cases, the resources invested in value added services, or intelligent network platform, have been considered worthwhile after the revenue of the telecom company is increased, and better service to the subscribers is provided (Hamersma, 1996). In spite of this, there are few studies that have been developed in order to assess the impact that these innovative solutions have on increasing the connectivity of nations (Barendse, 2004).

The impact of pricing structures on the adoption of mobile telephones has not received much attention in the past (Hodge, 2005). The prepaid pricing alternative provides an opportunity for individuals to manage their telephone expenses, since the number of calls that can be made is restricted. This and the relatively simple subscription process generate a broad customer acceptance for prepaid phone services (Hamilton, 2003). In this dissertation, Systems Dynamics is used to investigate the prepaid pricing mechanism of telephone services, which could be used to design a value added service strategy that considerably improves the number of rural telephone lines based on the synergic impact of these services on network externality of the regional telephone system.

It was found that the implementation of prepaid phone, virtual telephony, and payphone services together significantly improved the financial resources of the telephone company and accelerated the rural dispersion of telephone services in developing countries. However, the success of this strategy will depend on the friendliness of the user interface and the availability of these services in the region. Finally, it is important to note that the implementation of these services in isolation only achieved a moderate improvement.

### **6.3 Value Added Services in Telecommunications**

The provision of value added services, such as voice mail, virtual telephony, prepaid phone, and payphone services, among others, represent an opportunity to improve the productivity or revenue from the local loops, and provide extra value or better service to the subscribers. The implementation of value added service platforms, which are called intelligent networks (IN), involves improving this network and introducing new services on this platform (Thorner, 1994).

The low level of telephone penetration in a country has sometimes been attributed to the fact that the telecommunications network is outdated. This prevents the deployment of value added services (Fretes-Cibils et. al., 2003). There is certain evidence that the introduction of prepaid phone services in mobile telephony has been able to expand the number of telephone lines in developing countries. However, the actual impact of this innovative pricing mechanism, which uses a VAS platform, is still unclear (Hodge, 2005). The Table 8 shows the growth of prepaid and postpaid cellular

phones in selected developing countries (World Telecommunication Indicators Database, 2004). It can be observed the exponential growth of prepaid telephones, which is much higher than the growth of postpaid phones. In addition, it can also be observed in this table the increasing gap between the number of prepaid and postpaid telephones through years.

There is a management trend in developing countries to overlook or delay the provision of valued added services, since the focus has been to address the large number of waiting lists or outstanding demand in the system (Saunders et. al., 1994). For instance, the investment in payphone services, which use the intelligent network platform, has been very low. The Table 9 shows the low level of penetration of payphone devices in selected developing countries, although there has been some growth. The penetration of payphones in developing countries is much lower than the penetration of payphones in developed countries, which is generally higher than two payphones per 1000 people (World Telecommunication Indicators Database, 2004).

The investment in value added services reduces the investment in telecom expansion but there is a potential to increase the financial resources of the telephone company in the long run. In addition, there is a belief in the telecom industry that investment in more advanced VAS from revenue generated in basic services, such as telephony, could divert the focus from the expansion of basic telecom infrastructure and universal service (Siochru, 1996). For this reason, the investment cost of the VAS platform needs to be trade-off against the potential increase of revenue and provision of better services to the subscribers (Hamersma, 1996).

In spite of the potential benefits that value added services could provide to the expansion of telephone services in developing countries, there are few studies developed in order to assess the impact that these innovative solutions have on increasing telecom penetration in these nations (Barendse, 2004). This research will study the impact of three different services: virtual telephony, payphone, and prepaid phone services.

The VAS studied in this dissertation target different markets and need several VAS infrastructures. The prepaid payphone service is offered to the population who is not interested in subscribing to the telephone service. This service requires the deployment of calling card numbers and public payphones. In addition, the virtual telephony service is offered to subscribers in the waiting list. This service is a combination of voice mail and payphone services. Therefore, it requires the deployment of mailboxes, calling card numbers, and public payphones. Finally, the prepaid phone service is offered to the population who does not have a telephone and is able to use this. This service requires the same infrastructure as the conventional postpaid telephone service and the deployment of calling card numbers, which is implemented in the intelligent network platform.

Countries	1998		Prepaid-Postpaid Ratio (1998)	2002		Prepaid-Postpaid Ratio (2002)	2002-1998 Growth (%)	
	Prepaid	Postpaid		Prepaid	Postpaid		Prepaid	Postpaid
Togo	6000	1500	4	168000	2000	84	2700	33
Bolivia	112247	127025	0.9	674710***	105207***	6.4***	501	-17
Ecuador	18450*	108055*	0.2*	1272333	288528	4.4	6796	167
Honduras	11875	23021	0.5	259156	67352	4	2082	192
Thailand	391000**	2665000**	0.15**	12735000	3382000	4	3157	26

\* year 1997, \*\* year 2000, \*\*\* year 2001

**Table 8. The Dispersion of Prepaid Cellular Phones in Selected Developing Market Economies.**

Source: World Telecommunication Indicators Database (2004).

Countries	Payphones						1998-1993	2002-1998
	1993	Payph/1000 pe	1998	Payph/1000 pe	2002	Payph/ 1000 pe	Payph Growth	Payph Growth
Zambia	526	0.06	554	0.05	878	0.08	0.05	0.58
Togo	68	0.01	132	0.03	12257	2.5	0.94	91.85
India	172000	0.1	527000	0.5	2006000	1.9	2.06	2.8
Bangladesh	1982	0.01	2023	0.01	2208	0.01	0.02	0.09
Pakistan	6000	0.04	28000	0.2	99000	0.6	3.66	2.53
Ecuador	3024	0.2	3846	0.3	5003	0.3	0.27	0.3
Honduras	861	0.1	2582	0.4	2583	0.3	2	0
Botswana	528	0.3	2449	1.5	2242	1.3	3.63	-0.08

**Table 9. The Dispersion of Payphones in Selected Developing Market Economies.**

Source: World Telecommunications Indicators Database (2004).

## 6.4 Impact of Value Added Services on Telephone Expansion

In this section, several experiments were conducted with different value added service implementations, which did not strategically consider the interactions and feedback loops of the regional telecommunications system. The base case, which indicates a cellular service without VAS implementation, is shown at the top of Table 10.

### **6.4.1 Payphone Service**

The prepaid payphone service uses payphones and calling card numbers as basic infrastructure. This service is intended for each person capable of using a payphone, who is not interested on being a subscriber of the current telephone service. The potential subscribers are attracted to the payphone service after considering its price, user-friendly interface, availability, and the number of subscribers reachable in the network, which is represented in the model by the network externality impact. The higher the network externality impact, the higher the number of people reachable in the network. This service is implemented in the model by setting the VAS Offered variable for Payphone services in both urban and rural areas to 1, and by increasing the VAS investment referential variable to 0.04. The VAS investment referential variable considers payphones as the only significant value added service infrastructure in terms of costs and deployment delays.

The total price paid by the payphone subscribers for the total number of calling cards used is relative to the willingness to pay for fixed telephone services, which depends on the network externality impact. The network externality is a function of the telephone density in the region (Saunders et. al., 1994). It is observed in Figure 17 that the number of telephone subscribers in the network affects the network externality impact of the system. The higher the telephone density and the network externality impact, the higher the willingness to pay for fixed telephone services and the number of calling cards consumed by the payphone subscribers. In addition, the payphone

subscribers consume an amount of prepaid calling cards based on the willingness to pay for fixed telephone services. The money spent in prepaid calling cards is called the payphone price in the model.

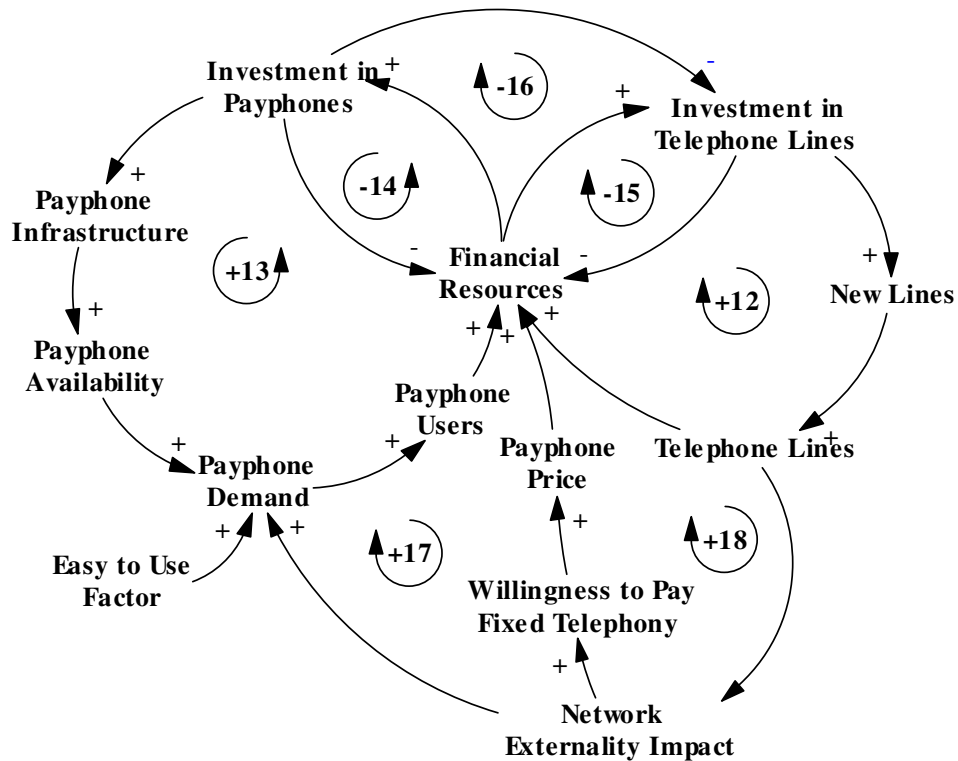
The performance of payphone services on the regional telecommunications system is observed in VAS 1 of Table 10. The national and regional telephone densities show a moderate improvement after the payphone service implementation, since the financial resources used for telephone expansion have been increased. For instance, in year 15, the financial resources were increased from its normalized value of 1.320 (Base Case) to 3.529 (VAS 1). On the other hand, the rural-urban telephone density gap is not improved in spite of the rural telephone density growth. This indicates that the improvement of financial resources is not strong enough to reduce also the rural-urban telecom gap.

The higher the number of telephones in the region the higher the network externality impact, which improves the payphone demand and the willingness to pay for fixed telephone services, as observed in positive feedback loops 17 and 18 of Figure 17. The enhancement on willingness to pay for fixed telephone services increases the number of prepaid payphone cards used in the system, which expands the payphone price. This situation enlarges the financial resources of the telephone company, as observed in positive feedback loop 18.

The improvement on payphone demand increases the number of payphone users, which also expands the financial resources of the telephone company because the revenue from payphone services is augmented, as observed in positive feedback loops



13 and 17 of Figure 17. As described before, the expansion of financial resources improves the number of telephone lines. The investment in payphone infrastructure is subtracted from the investment in telephone expansion, as shown by negative feedback loop 16 of Figure 17.



**Figure 17. Payphone Service Impact on Telephone Expansion**

### 6.4.2 Virtual Telephony Service

The virtual telephony service is a form of fixed telephone service, which is a combination of voice mail and prepaid payphone services. This implies that virtual telephony requires mailboxes, payphones, and calling cards, as basic infrastructure. This service targets telephone subscribers in the waiting list, who have decided to subscribe

to the service and to pay for the telephone device and activation fee, but the telephone company has not connected them yet. This service is implemented in the model by setting the VAS Offered variable for Virtual Telephony services in both urban and rural areas to 1, and by increasing the VAS investment referential variable to 0.04. The VAS investment referential variable considers payphones as the only significant value added service infrastructure in terms of costs and deployment delays.

The subscribers of virtual telephony were attracted to this service after considering its price, and other features such as user-friendly interface and availability. The price paid for the virtual telephony service is proportional to the willingness to pay for the fixed telephone service, which depends on the network externality impact. The virtual telephony users consume a number of calling cards relative to this willingness to pay. It is observed in Figure 18 that the number of telephone subscribers in the network affects the network externality impact of the system. The virtual telephony subscribers consume an amount of prepaid calling cards based on the willingness to pay for fixed telephone services. This determines the amount of money spent on these cards, which is called the virtual telephony price in the model.

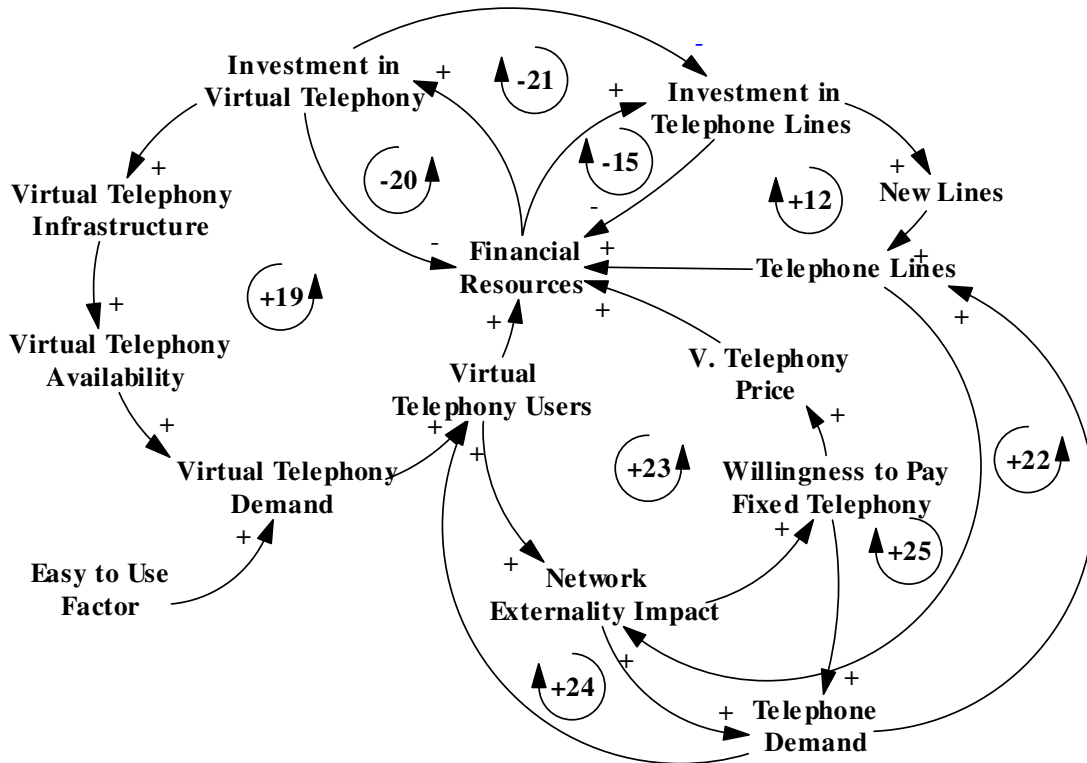
The performance of virtual telephony on the regional telecommunications system is observed in VAS 2 of Table 10. It is observed that the virtual telephony service is able to slightly improve in the long term the national and regional telephone densities, and the rural-urban telephone density gap is not improved. For instance, in year 9, the rural telephone density is reduced from its normalized value of 14.545 (Base Case) to 14.091 (VAS 2), and the urban telephone density is slightly improved from its

normalized value of 9.501 (Base Case) to 9.552 (Virtual Telephony). However in year 15, the rural telephone density is somewhat improved from 33.455 (Base Case) to 34.182 (VAS 2). The telephone density improvement is relative to the expansion of financial resources, which depends on the number of virtual telephony users and the price charged for the virtual telephony service, as observed in Figure 18.

The financial resources are not improved with respect to the base case, in spite of the minimum improvement on telephone densities. The increase of telephone densities is too low to improve the telephone revenue and the financial resources during the first fifteen years of the simulation. On the other hand, the increase on telephone densities and virtual telephony users enlarges the telephone expenses, in the form of telecom investment and operating costs. The Table 10 shows that in year 15, after the application of virtual telephony, the financial resources are still lower than the base case.

The simulations proved that the impact of virtual telephony on the system is low, which is described as follows. The growth in the number of virtual telephony and telephone subscribers improve the impact of network externality on the system, as observed in positive feedback loops 23 and 25 of Figure 18. This situation enhances telephone demand and the number of telephone subscribers in the network, which is shown in positive feedback loop 22. The improvement on telephone demand enlarge the number of potential telephone subscribers and the quantity of telephone subscribers in the waiting list, which also augment the number of virtual telephony users, as observed in positive feedback loop 24 in Figure 18. The higher network externality impact also

increases the willingness to pay for fixed telephone services, which improves the number of calling cards used by the virtual telephony subscribers. This situation is represented by the virtual telephony price observed in positive feedback loops 23 and 25 in Figure 18.



**Figure 18. Virtual Telephony Service Impact on Telephone Expansion**

### 6.4.3 Virtual Telephony and Payphone Services

The combination of virtual telephony and payphone services is simulated in the model and is shown in VAS 3 of Table 10. It can be seen that the combination of these two services performs better than the implementation of each of these in isolation, which are shown in VAS 1 and VAS 2. It is observed that the national and regional

telephone densities, and financial resources are improved with respect to the implementation of these services in isolation. However, the rural-urban telephone density gap is not reduced in spite of the rural telephone density growth.

The functioning of these two services was described in previous sections. However, it is important to emphasize that both services share a specific VAS infrastructure deployed in the region, the payphones. The sharing of this infrastructure makes the use of payphones more productive, since the investment in costly payphones is being recovered from revenue generated from both virtual telephony and payphone services, which is a result of the conjoint action of positive feedback loops 13, 17, 18, 19, 23, and 25 in Figures 17 and 18. This situation improves the financial resources of the telephone company, which is used for VAS and telephone expansion.

When these two services are combined, the number of virtual telephony subscribers enhances the network externality impact, as shown in positive feedback loop 24 of Figure 18. This improves the number of payphone users and the number of calling cards consumed by payphone subscribers, as observed in positive feedback loops 17 and 18 in Figure 17. This situation expands the financial resources of the telephone company and the number of telephone lines. The higher number of telephone lines strengthens even more the network externality impact, as observed in positive feedback loops 17, 18, and 25 in Figures 17 and 18.

#### **6.4.4 Prepaid Phone Service**

This service consists on the use of a VAS infrastructure implemented in the intelligent network of the telephone company, the prepaid calling card. The prepaid calling card is used as a mechanism of pricing, which replaces the conventional postpaid scheme. This service uses calling cards as basic infrastructure, where each subscriber will consume an amount of cards proportional to his/her willingness to pay. This service is implemented in the model by setting the VAS Offered variable for Prepaid Phone services in both urban and rural areas to 1, and by resetting the VAS investment referential variable to 0.

The prepaid cellular telephone service is implemented in parallel to the conventional postpaid cellular telephone service. The prepaid phone service allows subscribers not interested in the postpaid service, because of the commitment to pay the monthly rental fee and complex paper work requirement, to become interested in the telephone service according to their willingness to pay. It is important to note that the subscription process of this prepaid service does not involve major paper work and is usually delivered in a simple service pack.

The performance of the prepaid telephone service is observed in VAS 4 of Table 10. It can be seen that the implementation of a prepaid telephone service improves considerably the regional and national telephone densities, and the financial resources, in the long term with respect to other VAS implementations. However, the rural-urban telephone density gap disimprove since the urban telephone density has increased in a larger proportion than the rural density. For instance in year 15, the normalized

financial resources increased to 6.434 (VAS 4), which is much higher than the base case value of 1.32, and higher than the value of 4.178, obtained from the combined implementation of virtual telephony and payphones. The rural telephone density increased from the normalized value of 33.455 (Base Case) to 107.364 (VAS 4), and the rural-urban telephone density ratio reduced from 1.481 (Base Case) to 1.111 (VAS 4).

The relatively simple subscription process and the price based on the willingness to pay of the prepaid telephone service reduce the adoption delay with respect to the postpaid telephone service. This situation expedites the adoption of telephone lines for a prepaid telephone service, as observed in positive feedback loop 27 in Figure 19. In addition, the higher the willingness to pay for telephone services, the higher the number of prepaid calling cards demanded by the prepaid subscribers, as observed in positive feedback loops 26 and 27 of Figure 19. The higher the prepaid telephone service price, or the number of calling cards used, the higher the revenue and financial resources of the telephone company, which are used for telephone expansion.

The telephone expansion achieved by the improvement of the financial resources enhances the network externality impact of the system, as seen in positive feedback loops 26 and 27 of Figure 19. The higher network externality impact increases the willingness to pay for telephone services and the number of calling cards consumed by the prepaid subscribers. On the other hand, the improvement of the network externality impact increases the postpaid and prepaid telephone demand, which expands the number of postpaid and prepaid telephone lines respectively, as observed in positive feedback loops 28 and 29

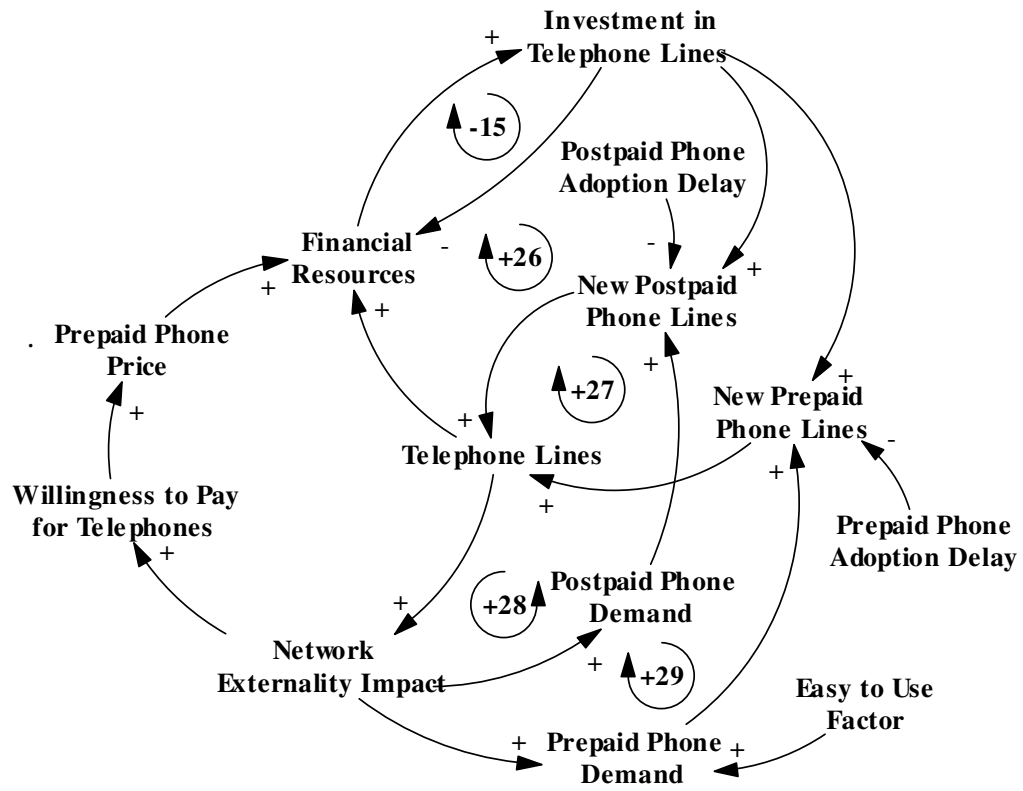


Figure 19. Prepaid Phone Service Impact on Telephone Expansion



		Years			
Base Run	Rural Tel. Density	1.000	11.000	14.545	33.455
	Urban Tel. Density	1.000	6.292	9.501	25.592
	National Tel. Density	1.000	6.599	10.212	28.525
	Rural/Urban T D Ratio	1.000	1.852	1.852	1.481
	Financial Resources	1.000	0.099	0.223	1.320
1. Payphones	Rural Tel. Density	1.000	10.636	15.727	53.364
	Urban Tel. Density	1.000	6.232	10.836	43.711
	National Tel. Density	1.000	6.535	11.631	48.664
	Rural/Urban T D Ratio	1.000	1.852	1.852	1.481
	Financial Resources	1.000	0.125	0.330	3.259
	Payphones/ 1000 people	0	0.067	0.096	0.325
2. Virtual Telephony	Rural Tel. Density	1.000	10.636	14.091	34.182
	Urban Tel. Density	1.000	6.232	9.552	27.518
	National Tel. Density	1.000	6.535	10.258	30.641
	Rural/Urban T D Ratio	1.000	1.852	1.852	1.481
	<i>Financial Resources</i>	<i>1</i>	<i>0.092</i>	<i>0.219</i>	<i>1.437</i>
	Payphones/ 1000 people	0	0	0	0
3. Virtual Telephony and Payphones	Rural Tel. Density	1.000	10.909	16.091	63.455
	Urban Tel. Density	1.000	6.516	11.592	53.569
	National Tel. Density	1.000	6.829	12.433	59.631
	Rural/Urban T D Ratio	1.000	1.852	1.481	1.481
	<i>Financial Resources</i>	<i>1</i>	<i>0.128</i>	<i>0.367</i>	<i>4.178</i>
	Payphones/ 1000 people	0.000	0.067	0.098	0.382
4. Prepaid Phones	Rural Tel. Density	1.000	7.636	15.455	107.364
	Urban Tel. Density	1.000	7.722	15.150	97.082
	National Tel. Density	1.000	7.995	16.147	107.880
	Rural/Urban T D Ratio	1.000	1.111	1.111	1.111
	<i>Financial Resources</i>	<i>1</i>	<i>0.189</i>	<i>2.766</i>	<i>6.434</i>
	Prepaid/Postpaid Ratio	0.000	2.021	0.616	8.492

Table 10. Impact of Different Value Added Services on Telephone Expansion

#### 6.4.5 Equations of Value Added Services

The value added service users (VASU) are increased by the rate of adoption of value added services (RAVAS) and by the prepaid phone connection rate (PPCR), and decreased by the attrition rate of value added services (ARVAS). The adoption rate of value added services (RAVAS) is a function of the parameter VAS users increase (VASUI). In the same manner, the attrition rate of VAS (ARVAS) is a function of VAS users decrease (VASUD). Finally, the prepaid phone connecting rate is function of the telephone capacity (TC), the fraction of lines connected per month (FLC), and the postpaid-prepaid waiting list fraction (PPWLF):

$$(d/dt) VASU_i^m = RAVAS_i^m - ARVAS_i^m \quad (\text{if } m = \text{php or vtp}) \quad (44)$$

$$(d/dt) VASU_i^m = PPCR - ARVAS_i^m \quad (\text{if } m = \text{pp})$$

$$RAVAS_i^m = VASUI_i^m$$

$$ARVAS_i^m = VASUD_i^m$$

$$PPCR_i = TC_i * FLC_i * (1 - PPWLF_i)$$

The potential users of value added services (PUVAS) are increased by the rate of growth of potential VAS users (GPUVAS) and by the attrition rate of value added services (ARVAS), and are decreased by the adoption rate of VAS (RAVAS), the rate of new prepaid phone customers (RNPPC), and by the discard of potential VAS users (DPUVAS):

$$(d/dt) PUVAS_i^m = GPUVAS_i^m + ARVAS_i^m - RAVAS_i^m - DPUVAS_i^m$$

$$(if\ m =\ php\ or\ vtp) \tag{45}$$

$$(d/dt) PUVAS_i^m = GPUVAS_i^m + ARVAS_i^m - RNPPC_i - DPUVAS_i^m$$

$$(if\ m =\ pp)$$

The waiting list of prepaid phone subscribers (WLPP) is increased by the rate of new prepaid phone customers (RNPPC) and decreased by the prepaid phone connection rate (PPCR):

$$(d/dt) WLPP_i = RNPPC_i - PPCR_i \tag{46}$$

The rate of growth of potential VAS users (GPUVAS) for the case of payphones (php) is function of the population growth (GPO) and the fraction of population able to use calling cards (FPAUC), and GPUVAS for virtual telephony is the sum of the rate of new postpaid customers (RNC) and the rate of new prepaid customers (RNPPC), which are the flows of people interested in the telephone service but not connected yet. Finally, the GPUVAS for prepaid phones is equal to the growth of the population of telephone subscriber (GPTS):

$$GPUVAS_i^{php} = GPO_i * FPAUC_i \tag{47}$$

$$GPUVAS_i^{vtp} = RNC_i + RNPPC_i$$

$$GPUVAS_i^{pp} = GPTS_i$$

The discard of potential VAS users (DPUVAS) for payphones (php) is function of the rate of new postpaid users (RNC) and the rate of new prepaid users (RNPPC).

The DPUVAS for virtual telephony (vtp) is a function of the rate of connecting postpaid subscribers (CR) and the rate of connecting prepaid customers (PPCR). Finally, the DPUVAS for prepaid phone (pp) is equal to the rate of people willing to pay the monthly rental fee of the postpaid telephone service or new potential customer rate (NPCR):

$$DPUVAS_i^{php} = RNC_i + RNPPC_i \quad (48)$$

$$DPUVAS_i^{vtp} = CR_i + PPCR_i$$

$$DPUVAS_i^{pp} = NPCR_i$$

The VAS users increase (VASUI) and VAS users decrease (VASUD) are a function of the VAS users adjustment (VASUAD):

$$VASUI_i^m = VASUAD_i^m \quad (\text{if } VASUAD_i^m > 0) \quad (49)$$

$$VASUD_i^m = -VASUAD_i^m \quad (\text{if } VASUAD_i^m < 0)$$

The VAS users adjustment (VASUAD) is a function of the indicated VAS users (IUVAS), the actual VAS users (VASU), and the delay to adjust VAS users (DADUV).

$$VASUAD_i^m = (IUVAS_i^m - VASU_i^m) / DADUV \quad (50)$$

The indicated users of value added services (IUVAS) are a function of the maximum demand for a particular VAS (MAXDVAS) and the demand fraction of VAS (DFVAS):

$$IUVAS_i^m = MAXDVAS_i^m * DFVAS_i^m \quad (51)$$

The maximum demand of virtual telephony (vt), payphone (php), and prepaid phone (pp) services (MAXDVAS) is function of the number of value added service users (VASU), the potential VAS users (PUVAS), and the population of potential and actual telephone subscribers (PTS):

$$MAXDVAS_i^m = VASU_i^m + PUVAS_i^m \quad (\text{if } m = \text{vt or php}) \quad (52)$$

$$MAXDVAS_i^m = PTS_i \quad (\text{if } m = \text{pp})$$

The demand fraction of VAS (DFVAS) is function of the price fraction of VAS (PFVAS), the availability of VAS fraction (AVASF), the easy to use of VAS factor (EUVASF), and the network externality impact (NEI). The user interface of the payphone service is a characteristic that indicates how easy is to handle a payphone with a prepaid calling card. This will influence the efficient use and adoption of this VAS (Thorner, 1994). The friendliness of this interface has been ranked from zero to one, which indicates impossible and very easy to use respectively. The normal values used in the model for the payphone easy to use factor are 0.7 for rural areas and one for urban areas. On the other hand, the user interface of the virtual telephony service is a characteristic that indicates how easy is to handle a payphone, a prepaid calling card, and a mailbox together. The normal values used in the model for the virtual telephony easy to use factor are 0.5 for rural areas and 0.7 for urban areas. Finally, the easy to use factor value of the prepaid telephone service is assumed one. This indicates that the prepaid calling card is very easy to handle:

$$DFVAS_i^m = PFVAS_i^m * AVASF_i^m * EUVASF_i^m \quad (\text{if } m = \text{vtp}) \quad (53)$$

$$DFVAS_i^m = (PFVAS_i^m * AVASF_i^m * EUVASF_i^m) * NEI_i \quad (\text{if } m = \text{php or pp})$$

The price fraction of VAS (PFVAS) is a non-linear function of the ratio between the price of VAS (PVAS) and the normal price of VAS (NPVAS):

$$PFVAS_i^m = f_{6i}(PVAS_i^m / NPVAS_i^m) \quad (54)$$

Where  $f'_{6i} < 0$

The prices of VAS (PVAS) and the normal prices of VAS (NPVAS) are function of the willingness to pay for telephone services (WTPTS), which could be fixed or mobile, and the willingness to pay for fixed telephone services (WTPFTS). This indicates that the price of prepaid phone services equals the willingness to pay for telephone services and that the price of virtual telephony and payphone services equals the willingness to pay for fixed telephone services:

$$NPVAS_i^m = PVAS_i^m = WTPTS_i \quad (\text{if } m = \text{pp}) \quad (55)$$

$$NPVAS_i^m = PVAS_i^m = WTPFTS_i \quad (\text{if } m = \text{vt or php})$$

The willingness of pay for telephone services (WTPTS) is equal to the subscriber expenditure on telecommunications (SET). On the other hand, the willingness to pay for fixed telephone services (WTPFTS) is function of the normal expenditure on telecommunications (NETS) and the telecom expenditure increase from size of the network (TEISN):

$$\text{WTPTS}_i = \text{SET}_i \quad (56)$$

$$\text{WTPFTS}_i = \text{NETS}_i * \text{TEISN}_i$$

The availability of VAS fraction (AVASF) for payphones (php) is function of the infrastructure availability (IA) of payphone devices (phpd) and the infrastructure availability (IA) of calling card numbers (ccn). The availability of VAS fraction (AVASF) for virtual telephony is a function of the infrastructure availability (IA) of mailboxes (mb), the infrastructure availability (IA) of payphone devices (phpd), and the infrastructure availability (IA) of calling card numbers (ccn). Finally, the AVASF for prepaid phones is a function of the infrastructure availability of calling card numbers (ccn). The availability of payphone and virtual telephony services is mainly influenced by the availability of payphone infrastructure. The superscript n refers to any type of value added service infrastructure, mailboxes (mb), payphone devices (pphd), and calling card numbers (ccn):

$$\text{AVASF}_i^{\text{php}} = \text{IA}_i^{\text{phpd}} * \text{IA}_i^{\text{ccn}} \quad (57)$$

$$\text{AVASF}_i^{\text{vtp}} = \text{IA}_i^{\text{mb}} * \text{IA}_i^{\text{phpd}} * \text{IA}_i^{\text{ccn}}$$

$$\text{AVASF}_i^{\text{pp}} = \text{IA}_i^{\text{ccn}}$$

The infrastructure availability (IA) of payphone devices (pphd) is a function of the payphone infrastructure installed (PAYII) , the population of the region (POP), and the referential payphone device availability per person (RPA):

$$IA_i^{pphd} = (PAYII_i / POP_i) / RPA \quad (58)$$

The infrastructure availability (IA) of mailboxes and calling card numbers is assumed one in the model, since the deployment delays and costs of each of these VAS infrastructures are much lower than the deployment delay and cost of the payphone infrastructure. This means that mailboxes and calling card numbers are always considered available.

The referential payphone device availability per person (RPA) has a maximum level of three payphones per 1000 people. This threshold is typical for developed countries with a considerable penetration of payphones (World Telecommunication Indicators Database, 2004).

The payphone devices infrastructure installed (PAYII) are increased by payphone deployment rate (PAYDR) and decreased by payphone discard rate (PAYDIR). The payphone deployment rate (PAYDR) is function of the payphone deployment in progress (PAYDIP) and the payphone deployment delay (PAYDD). The payphone discard rate is function of the payphone infrastructure installed (PAYII), the payphone deployment in progress (PAYDIP), the desired payphone infrastructure installed (DPAYII), and the delay to adjust payphone Infrastructure (DAPAYI):

$$(d/dt) PAYII_i = PAYDR_i - PAYDIR_i \quad (59)$$

$$PAYDR_i = PAYDIP_i / PAYDD_i$$

$$PAYDIR_i = (PAYII_i + PAYDIP_i - DPAYII_i) / DAPAYI_i$$



The implementation of mailboxes and calling cards are simplified in the model, since the deployment delay of mailboxes and calling card numbers could be less than six months (Macías, 2005). We are assuming that the deployment delay of calling cards and mailboxes is one month. On the other hand, the implementation of payphone devices includes the cellular line deployment time, which is three months for urban areas and six months for rural areas (Plaza and Iñiguez, 2005), and the payphone device installation time, which is also assumed one month.

The payphone deployment in progress (PAYDIP) is increased by new orders of payphone infrastructure deployment (NOPAYD) and decreased by payphone deployment rate (PAYDR). The new orders of payphone infrastructure deployment (NOPAYD) are function of the payphone infrastructure installed (PAYII), the payphone deployment in progress (PAYDIP), the desired payphone infrastructure installed (DPAYII), and the delay to adjust payphone infrastructure (DAPAYI):

$$(d/dt) PAYDIP_i = NOPAYD_i - PAYDR_i \quad (60)$$

$$NOPAYD_i = (DPAYII_i - PAYII_i - PAYDIP_i) / DAPAYI_i$$

The desired payphone infrastructure (DPAYII) is function of the supplied payphone infrastructure (SPAYI) and the maximum payphone infrastructure demanded (MPAYID):

$$DPAYII_i = SVASI_i \quad (\text{if } MPAYID_i > SPAYI_i) \quad (61)$$

$$DPAYII_i = MPAYID_i \quad (\text{if } SPAYI_i > MPAYID_i)$$

The cost of the payphone infrastructure or payphone device ( $CPAYI_i$ ) is the sum of the cost of the payphone device ( $CPD$ ) and the cost of telephone line ( $COT$ ). The cost of the payphone device is assumed 500 dollars, and the cost of a cellular telephone line is assumed 200 dollars for urban areas and 300 dollars for rural areas (Plaza and Iñiguez, 2005). The cost of payphone infrastructure is relatively high when compared with the cost of calling cards and mailboxes. The cost of the payphone device is assumed 500 dollars, and the cost of a cellular telephone line is assumed 200 dollars for urban areas and 300 dollars for rural areas (Plaza and Iñiguez, 2005). The cost of payphone infrastructure is relatively high when compared with the cost of calling cards and mailboxes. The cost of a calling card number is five dollars and the cost of a mailbox is ten dollars (Macías, 2005). :

$$CPAYI_i = CPD + COT_i \quad (62)$$

The maximum infrastructure demanded for payphone devices ( $MPAYID_i$ ) is a function of the population ( $POP$ ) and the referential payphone availability per person ( $RPA$ ):

$$MPAYID_i = POP_i * RPA \quad (63)$$

The investment in payphone infrastructure ( $IPAYI$ ) is a function of the total allocated investment in payphones ( $TIPAY$ ) and the fraction of investment in payphone infrastructure ( $FIPAYI$ ). The total investment in payphone ( $TIPAY$ ) is a function of the total potential investment ( $TPI$ ) and the percentage of investment in value added service

(PIVAS). As described before, we are assuming that infrastructure availability (IA) of mailboxes and calling card numbers is one. Therefore, the process of deployment of mailboxes and calling card numbers can be simplified and the only VAS infrastructure deployment process actually simulated in the model is the correspondent to payphone infrastructure. For this reason, the percentage of investment in VAS (PIVAS) is equal to the percentage of payphone investment, which is assumed 0.4 percent:

$$IPAYI_i^n = TIPAY * FIPAYI_i^n \quad (64)$$

$$TIPAY = TPI * PIVAS$$

### **6.5 A Value Added Service Strategy for Improving Regional Telecommunications**

The implementation of a prepaid phone service alone without any other VAS implementation is observed at the top of Table 11 (VAS 1) and represents a referential case for the following set of simulations that describe the VAS strategy. The strategy will show the synergy that is generated when different value added services are strategically combined and strengthen some key positive feedback loops of the system.

The strategy combines the individual impact that prepaid phone, virtual telephony, and payphone services have on telephone expansion, which was described in previous sections and are shown in Figures 17, 18, and 19. The implementation of a prepaid phone service together with virtual telephony and payphone services uses the same investment in payphones for the virtual telephony and payphone services simultaneously. This makes costly payphones more productive since revenues from

virtual telephony and payphone phone calls are collected using the same payphone infrastructure. It is important to note that the major portion of the investment required to provide virtual telephony and payphone services is on the payphone infrastructure, which is subtracted from the investment in telephone expansion, as observed in negative feedback loops 16 and 21 of Figures 17 and 18 respectively.

The performance of this VAS strategy is observed in VAS 2 and VAS 3 of Table 11. The VAS 2 implementation has a low payphone investment of 0.4 percent of the total investment budget. This improves the national and regional telephone density of the country, with respect to the referential case. However, the rural-urban teledensity gap is not improved in spite of the rural telephone density growth. For instance in year 15, the normalized rural telephone density is improved from its normalized value of 107.36 (VAS 1) to 284.90 (VAS 2), and the urban telephone density is improved from 97.082 (VAS 1) to 138.72 (VAS 2).

On the other hand, the VAS 3 implementation increases the payphone investment from 0.4 to 4 percent. It is observed that the improvement on the level of payphone infrastructure considerably increases the national and regional telephone density of the country and increases the rural-urban telephone density ratio. For instance in year 15, the rural telephone density increases to 2,270 (VAS 3), which is much higher than 284.9 (VAS 2) and 107.36 (VAS 1). The urban telephone density increases to 162.49 (VAS 3), which is higher than 138.725 (VAS 2) and 97.082 (VAS 1). The rural-urban telephone density ratio is increased to the normalized value of 16.67 (VAS 3), which is much higher than the value of 1.11 observed in VAS 1 and VAS 2. This occurs

due to the combined action of positive feedback loops 13, 18, 19, 23, 24, 25, 26, 27, 28, and 29 in Figures 17, 18, and 19, which strengthen the network externality impact in the system. As described before, this improves the telephone service willingness to pay and the prepaid and postpaid telephone demand, which expand the financial resources of the telephone company and the total number of telephone lines.

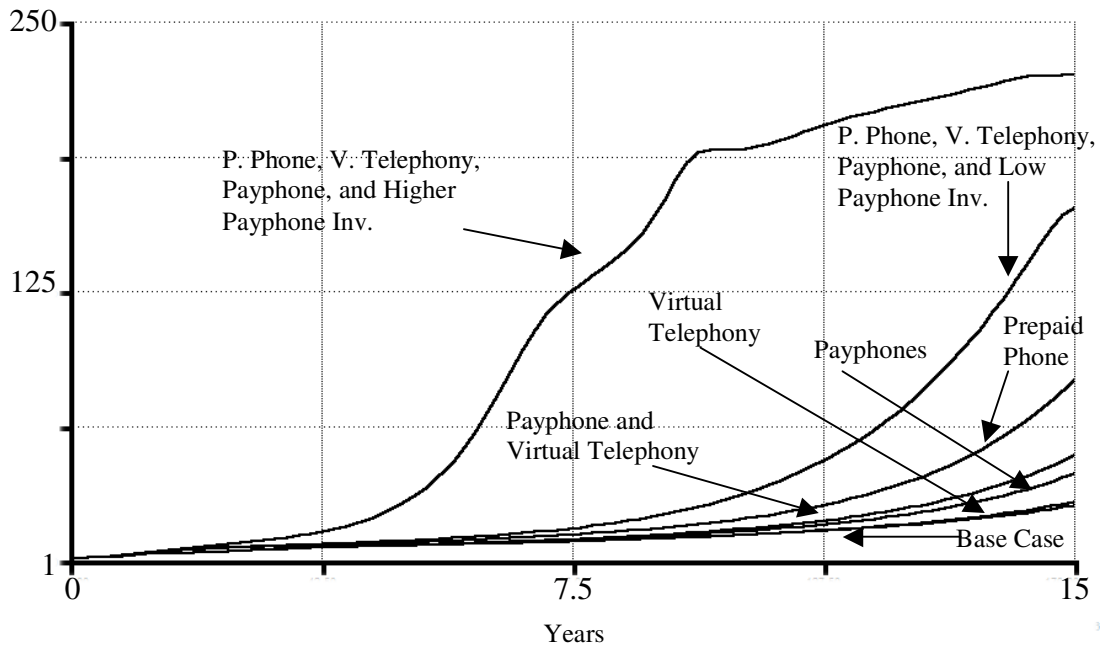
This combination of services enhances the network externality impact by expanding the number of people connected to the system. The network externality improvement increases the willingness to pay for telephone services and the prepaid and postpaid telephone demand. The improvement on the telephone service willingness to pay expands the expenditure on prepaid virtual telephony, payphone, and telephone services, as shown in Figures 17, 18, and 19. This situation increases the revenue and financial resources of the telephone company, as seen in VAS 2 and VAS 3 of Table 11. The enhanced prepaid and postpaid telephone demand improves the number of prepaid and postpaid telephone subscribers in the network, as observed in positive feedback loops 28 and 29 of Figure 19. This expands the financial resources of the telephone company, as indicated in positive feedback loops 26 and 27.

The higher the number of payphones functioning in the region, the higher the availability of payphone and virtual telephony services. This situation increases the willingness to pay for these services, which improves their demand and adoption. The growth of virtual telephony and payphone users expands the financial resources of the telephone company, as observed in positive feedback loops 13 and 19 of Figures 17 and 18 respectively. The performance and behavior of the VAS implementations described

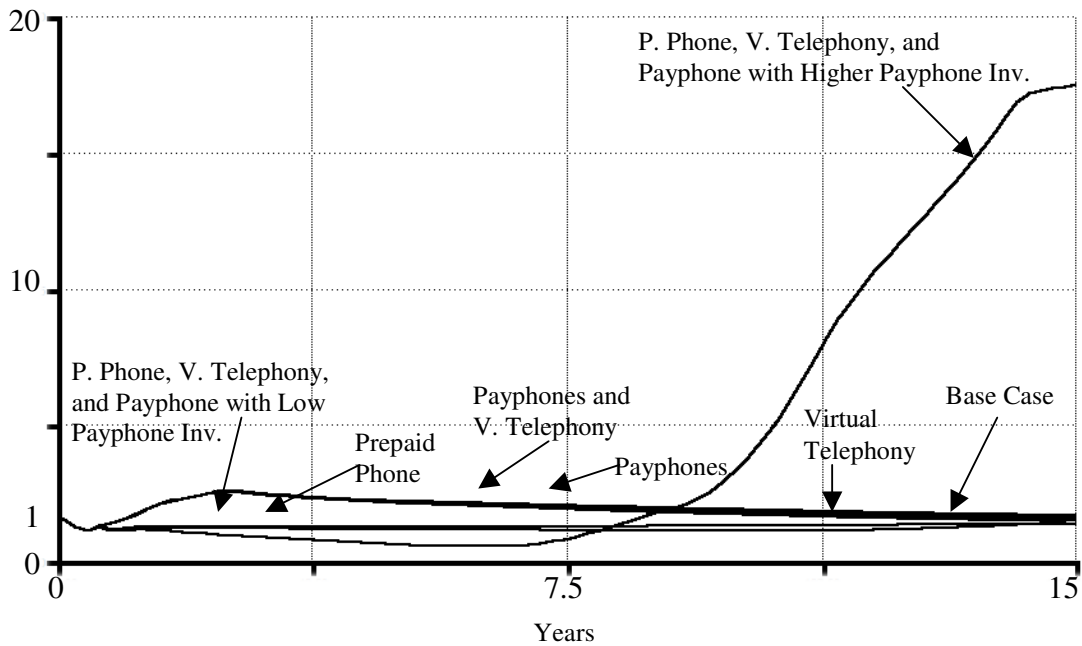
in this and previous sections are also observed in Figures 20 and 21, which show the national teledensity and the rural-urban teledensity gap.

		Years			
VAS	Telecom Indicators	0	5	9	15
1. Prepaid Phone without any other VAS	Rural Tel. Density	1.000	7.636	15.455	107.364
	Urban Tel. Density	1.000	7.722	15.150	97.082
	National Tel. Density	1.000	7.995	16.147	107.880
	Rural/Urban T D Ratio	1.000	1.111	1.111	1.111
	Financial Resources	1.000	0.189	0.616	8.492
	<i>Prepaid/Postpaid Ratio</i>	<i>0</i>	<i>2.021</i>	<i>2.060</i>	<i>2.000</i>
2. Prepaid Phone , Virtual Telephony , and Payphone Serv. with Low Payphone	Rural Tel. Density	1.000	8.000	19.818	284.909
	Urban Tel. Density	1.000	8.643	22.697	138.725
	National Tel. Density	1.000	8.935	24.129	156.313
	Rural/Urban T D Ratio	1.000	1.111	1.111	1.111
	Financial Resources	1.000	0.232	1.139	39.718
	<i>Payphones/ 1000 people</i>	<i>0</i>	<i>0.048</i>	<i>0.123</i>	<i>1.688</i>
	<i>Prepaid/Postpaid Ratio</i>	<i>0</i>	<i>2.055</i>	<i>2.172</i>	<i>2.198</i>
3. Prepaid Phone , Virtual Telephony , and Payphone Serv. with Higher Payphone	Rural Tel. Density	1.000	14.091	322.818	2270.000
	Urban Tel. Density	1.000	31.360	162.493	162.493
	National Tel. Density	1.000	32.120	175.991	209.263
	Rural/Urban T D Ratio	1.000	0.370	2.222	16.667
	Financial Resources	1.000	1.313	26.436	170.383
	<i>Payphones/ 1000 people</i>	<i>0</i>	<i>0.742</i>	<i>2.203</i>	<i>3.000</i>
	<i>Prepaid/Postpaid Ratio</i>	<i>0</i>	<i>2.579</i>	<i>3.174</i>	<i>2.700</i>

**Table 11. Value Added Service Strategy for Improving Rural Telephony in  
Developing Countries with a Cellular Access Network**



**Figure 20. Normalized National Teledensity for VAS Implementations**



**Figure 21. Normalized Rural Urban Teledensity Gap for VAS**

**Implementations**

## 6.6 Base Case Values

<b>Model Parameters</b>	<b>Base Case</b>
1. Monthly Rental Fee (Urban and Rural)	\$1
2. Urban Income per Capita	\$1708
3. Rural Income per Capita	\$310
4. Total Connected Subscribers Initial	50,000
5. Percent. Rural Lines	2.5%
6. ITU Waiting List	30,000
7. Waiting List Unreported Factor	4
8. Initial Population	23,000,000
9. % Rural Population	40%
10. Urban Population Growth Rate	2.3%
11. Rural Population Growth Rate	0.2%
12. Urban Cost per Line	\$200
13. Rural Cost per Line	\$300
14. Cost of each Mailbox	\$10
15. Cost of each C.Card Number	\$5
16. Cost of each Payphone Dev.	\$500
17. Telephone Deployment Time (Urban)	3 mo.
18. Telephone Deployment Time (Rural)	6 mo.
19. Percentage Payphone Investment	0%
20. Number of Telephones per Urban House	2
21. Number of Telephones per Rural House	1
22. Initial Cash Balance	\$50 Millions
23. Investment in Rural Areas	3.5%
24. Delay to Accept Activation Fee	3 mo.
25. Easy to Use Factor Virtual Telephony (Urban)	0.7
26. Easy to Use Factor Virtual Telephony (Rural)	0.5
27. Easy to Use Factor Payphone (Urban)	1



28. Easy to Use Factor Payphone (Rural)	0.7
29. Easy to Use Factor Prepaid Phone	1
30. Referential Payphone Availability	0.003
31. Wireless Flag (urban and rural)	1
32. License Cost	\$50 Millions
33. Activation Fee (Urban)	\$ 76
34. Activation Fee (Rural)	\$ 22
35. Price of International Traffic per Minute	\$ 1
36. Time to Recognize Attractiveness	6 mo.
37. Time to Adjust Demand (Urban and Rural)	60 mo.
38. Incoming-Outgoing International Traffic Ratio	3
39. Delay to Adjust Lines (Urban and Rural)	3 mo.
40. Initial Telephones to Connect (Urban)	10,000
41. Initial Telephones to Connect (Rural)	100
42. Regional Fraction Waiting List (Urban)	0.8
43. Regional Fraction Waiting List (Rural)	0.2
44. Fraction of Telephone Capacity per Month	0.25
45. License Duration	15 years
46. Free Local Minutes (Urban and Rural)	100 min
47. Fraction of Cap Cost as part of Op. Cost	0.3
48. Urban Weight on Externality (Urban)	0.9
49. Urban Weight on Externality (Rural)	0.5
50. Rural Weight on Externality (Urban)	0.1
51. Rural Weight on Externality (Rural)	0.5
52. Free Local Minutes Used (Urban)	100
53. Free Local Minutes Used (Rural)	50
54. Expenditure on Traffic as Fr. of Income (Urb)	0.01
55. Expenditure on Traffic as Fr. of Income (Rur)	0.006
56. Fraction of Expenditure on Telecom (Urban)	0.015
57. Fraction of Expenditure on Telecom (Rural)	0.015

58. Number of Payphone Users per House	2
59. Delay to Adjust VAS (Users)	3 mo.
60. Delay to Adjust Payphone Infrastructure	3 mo.
61. Payphone Devices Implementation Delay	1 mo.
62. Urban Investment Fraction (Payphone Infra)	0.965
63. Number of People per House	4
64. VAS Investment referential	0
65. VAS Offered	0

**Table 12. Base Case values of Value Added Services Analysis**

### **6.7 Sensitivity Analysis of Value Added Service Strategy**

Several experiments were conducted to test the sensitivity of the VAS strategy to changes in the characteristics and costs of these value added services and different perceptions of the population about them. The user interface of these services became more complex and difficult to handle, then the easy to use factor of virtual telephony, payphone, and prepaid phone services were considerably reduced. On the other hand, the perception of the population about the availability of payphones in the region got more stringent, and then the payphone availability referential was increased. Finally, the investment in VAS infrastructure comes to be more costly, and then the cost of each calling card, mailbox, and payphone was raised. The simulation results of the sensitivity analysis are shown in Table 13.

The virtual telephony easy to use factor was reduced from 0.7 to 0.3 in urban areas and from 0.5 to 0.15 in rural areas. The payphone easy to use factor was reduced from one to 0.5 in urban areas and from 0.7 to 0.3 in rural areas. The cellular prepaid phone easy to use factor was reduced from one to 0.5 in urban and rural areas. On the

other hand, the referential payphone availability was increased from three payphones per 1000 people to five payphones per 1000 people. Finally, the cost of a calling card number was increased from five to ten dollars, the cost of a telephone mailbox was increased from ten to twenty dollars, and the cost of each payphone device was raised from 500 to 800 dollars.

It is observed in VAS 2 and VAS 3 of Table 13 that the provision of prepaid phone, virtual telephony, and payphone services together using a cellular network still improve the national and regional telephone densities under this new scenario, in the long term, with respect to the base case and the prepaid phone service implemented alone, which is indicated in VAS 1. In addition, it is also observed in VAS 2 and VAS 3 that increasing the investment in payphone expansion from four to ten percent improve the telephone densities and the rural-urban telephone density gap. However, this sensitivity analysis also shows that the rural-urban telephone density gap is not improved with respect to the base case, in spite of an important growth in telephone densities and financial resources. Therefore, it is important to emphasize that the positive impact of VAS described in previous sections depends mainly on the friendliness of the user interface or easy to use factor and the availability or easy to acquire of these services in the region. The better the user interface and more reachable are these value added services in the country, the higher the improvement that this VAS implementation is able to produce in the regional telecom system.

		Years			
VAS	Telecom Indicators	0	5	9	15
Base Run	Rural Tel. Density	1.000	11.000	14.545	33.455
	Urban Tel. Density	1.000	6.292	9.501	25.592
	National Tel. Density	1.000	6.599	10.212	28.525
	Rural/Urban T D Ratio	1.000	1.852	1.852	1.481
	Financial Resources	1.000	0.099	0.223	1.320
1. Prepaid Phone, without any other VAS	Rural Tel. Density	1.000	7.455	14.091	77.909
	Urban Tel. Density	1.000	7.462	13.671	70.198
	National Tel. Density	1.000	7.724	14.571	78.018
	Rural/Urban T D Ratio	1.000	1.111	1.111	1.111
	Financial Resources	1.000	0.167	0.482	5.662
2. Prepaid Phone, Virtual Telephony, and Payphone Serv. 4% Payphone Inv.	Rural Tel. Density	1.000	6.727	12.727	98.273
	Urban Tel. Density	1.000	6.853	13.538	98.244
	National Tel. Density	1.000	7.092	14.410	108.986
	Rural/Urban T D Ratio	1.000	1.111	1.111	1.111
	Financial Resources	1.000	0.140	0.465	7.824
	<i>Payphones/ 1000 people</i>	<i>0.000</i>	<i>0.275</i>	<i>0.536</i>	<i>3.405</i>
3. Prepaid Phone, Virtual Telephony, and Payphone Serv.& 10% Payphone Investment	Rural Tel. Density	1.000	5.727	10.818	130.000
	Urban Tel. Density	1.000	6.088	12.688	106.232
	National Tel. Density	1.000	6.295	13.484	118.249
	Rural/Urban T D Ratio	1.000	1.111	1.111	1.481
	Financial Resources	1.000	0.107	0.398	9.579
	<i>Payphones/ 1000 people</i>	<i>0.000</i>	<i>0.572</i>	<i>1.093</i>	<i>3.663</i>

**Table 13. Value Added Service Strategy for Improving Rural Telephony in Developing Countries with a Higher VAS Infrastructure Costs and Payphone Availability Referential, and Lower VAS Easy to Use Factor.**

## **6.8 Conclusions**

This chapter presents an investigation of value added services on the expansion of telephone capacity in developing countries. It was found that a strategic implementation of value added services are able to accomplish the purpose of improving the telephone penetration in the country. The implementation of these value added services in isolation moderately improved the number of telephone lines. However, it proved that prepaid phone, virtual telephony, and payphone services, which are innovative services over the telephone network, are able to considerably improve the financial resources of the telephone company and accelerate the dispersion of telephone lines in rural areas of developing countries, only when implemented together.

The prepaid phone service pricing mechanism is based on the willingness to pay of the subscribers. The combination of virtual telephony with prepaid phone service reinforces the impact of network externality on the system, which increases the willingness to pay and revenue of the telephone service per subscriber. The addition of the payphone service to the previous combination improves the revenue and financial resources of the telephone company, which are used for telephone expansion and value added service implementation. Finally, the easy to use and easy to acquire of these value added services are important characteristics that need to be constantly improved in order to be able to reach the important growth in telephone penetration observed in this study.

## **Chapter 7. An Analysis of Wireless Technologies on the Regional Dispersion of Telephone Services in Developing Countries.**

### **7.1 Introduction**

The access plant of the traditional telephone network, as opposed to the switches and backhaul connections, is extremely unproductive and underutilized, and shows fewer economies of scales since it is largely dedicated. The access plant is considered the largest asset of the telephone network, since this can account for more than half of the total assets of the company. The traditional access plant is wired, and is largely a function of the distance from the subscriber to central office or switching equipment. For this reason, the cost to provide a telephone line to a rural subscriber could be ten times the cost for an urban subscriber (Calhoun,1992).

Wireless technologies, such as cellular networks and Wireless Local Loop (WLL), are being seen as a way to increase telephone density in developing countries, due to its rapid deployment and lower cost (Noerpel, 1997). The cellular networks have grown rapidly in developing countries in recent years, especially in cities and other urban areas. The wireless technologies are less sensitive to distance than traditional wired technologies, which makes them more attractive for deployment in dispersed or scattered rural environments. However, there are still several questions regarding their viability in developing countries. For instance, the lack of electricity and reliable power supply has been considered the biggest challenge in deploying wireless systems in rural areas (Rycroft, 1998).

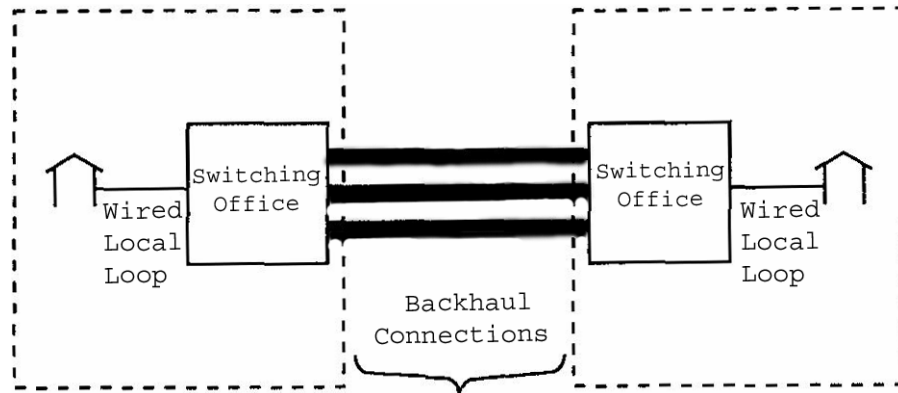
Due to the high cost of subscriber equipment and quality problems, the implementation of WLL services in developing countries has been limited (Robledo and Arathoon, 2002). My investigation showed, however, that WLL could be a viable alternative, especially in low-density areas, where the cost of wired systems increases considerably and the large coverage and low deployment delay of WLL systems become significant determinants of dispersion of telephone services.

Cellular systems are considered the best technology currently in the market that is able to accelerate the growth of telephone services in developing countries for urban areas. However, it was found that in thinly populated rural areas, WLL performs better than any other access technology including cellular systems. In this scenario, the cellular access network still performs better than the conventional wired telephone network.

## **7.2 Impact of Access Technologies on Telephone Expansion**

The wired access plant is the largest component of a conventional telephone network, since the cost of the backhaul connections and switches are considered insignificant when compared with the cost of the access component (Webb, 2000). Figure 22 shows a schematic of the wired telephone network, which includes the wired local loop, the switching office also known as central office or local exchange, and the backhaul connections. The wired local loop connects the switching office to the subscriber, and the backhaul connections interconnect the switching offices. The wired access plant, which goes from the switching office to the subscriber, includes the local

loops associated with access and can account for more than fifty percent of the book assets of the telephone company.



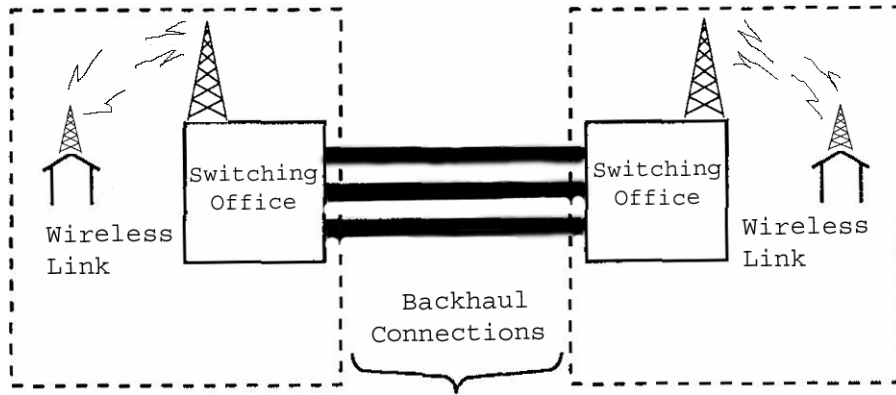
**Figure 22. Schematic of a Wired Telephone Network**

It has been observed that the costs of wired local loops increases at a greater than linear rate as a function of the distance, and decreases as the subscriber density increases (Calhoun, 1992; Mannisto and Tuisku, 1994; Webb, 2000). This situation occurs because longer wired loops require more cable, and also the additional loading coils and larger gauge cable. Historically, the telecom implementation has started in more dense urban areas, and then it has moved toward less dense suburban or rural areas, which have represented a transition to lower economies of scale, longer loop distances, and higher deployment costs (Saunders et. al., 1994). In rural areas, where the population density is very low, the cost of the wired local loop could be more than ten times the cost in urban areas (Calhoun, 1992).

The wireless technologies are seen as an alternative to the access plant, which can replace the dedicated and underutilized copper wire with a shared and more



efficient radio spectrum among subscribers (Duckworth, 2004). Figure 23 shows the schematic of a telephone network with a wireless access plant, where the wired local loop of a conventional telephone network has been replaced with a wireless link, which can be fixed for the case of Wireless Local Loop systems or mobile for the case of cellular systems. The cost of wireless systems has less sensitivity to distance and subscriber density than wired systems, since it has little impact where the subscribers are located inside the area of coverage of the radio cell. However, it is important to emphasize that there could be some extra costs associated with very remote subscribers living in fringe coverage zones, where it may be necessary to install a higher subscriber antenna with higher gain (Calhoun, 1992).



**Figure 23. Schematic of a Telephone Network with Wireless Access Plant**

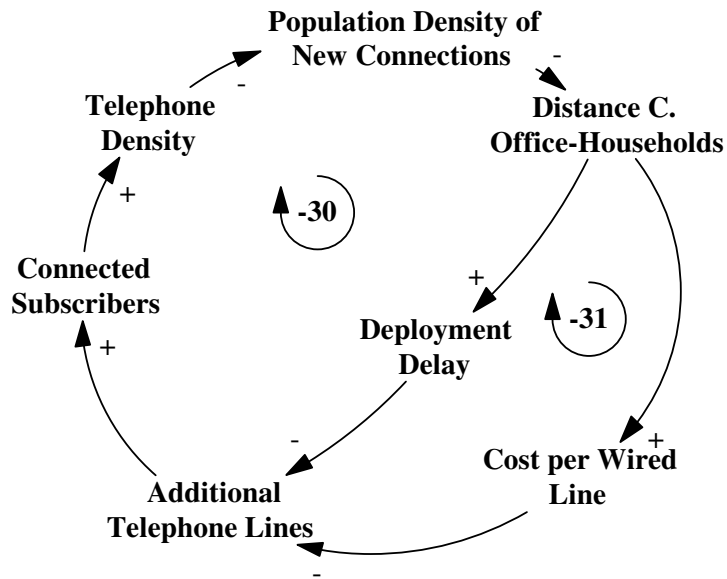
The wireless technologies, such as cellular and WLL, have been considered to have the potential to increase telephone density in developing countries, because of its rapid deployment and lower implementation costs (Noerpel, 1997; Hamersma, 1996). In addition, wireless systems are supposed to reduce the relative cost difference between

urban and rural deployment, so while rural access still remains more costly, the difference is not as big as for wired technology. In spite of the potential advantages of wireless technologies, there are still several questions regarding the quality of service and viability of implementation. The lack of electricity and reliable power supply in developing regions has been considered the biggest challenge in deploying wireless systems (Rycroft, 1998).

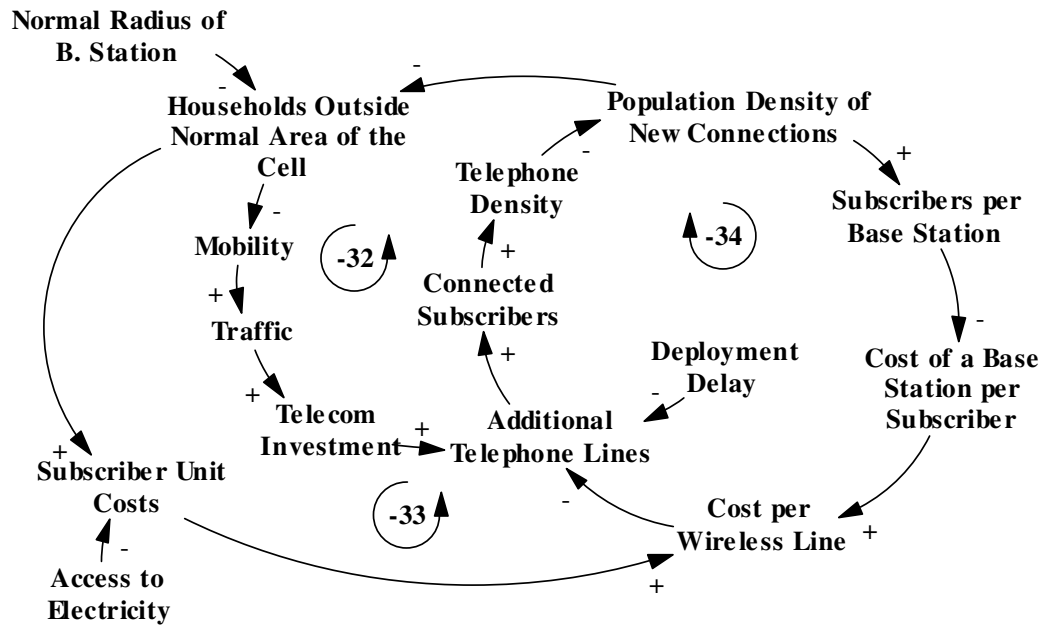
The causal structures for the development of wired and wireless access technologies in the regional telecommunications system are shown in Figures 24 and 25 respectively. In these figures, it can be observed that the cost of the access technology affects the provision of new telephones, which increases the total number of connected subscribers. The increase of connected subscribers improves the telephone density, which determines the population density of unserved areas or new connections. The higher the telephone density, the lower the population density of new connections, which become more remote or rural (Warren, 2002). In addition, the population density determines the average distance between subscribers. This distance has a direct impact on the cost of a wired telephone line and also influences the deployment time (Webb, 2000), which affects the supply of new telephone lines as shown in Figure 24.

The causal structure of the wireless access technology is shown in Figure 25. The population density of new connections determines the area of the cell, which has a direct impact on the cost of the subscriber units. As the distance from the subscriber to the base station increases, more expensive equipment is needed on the subscriber side. In addition, the access to electricity has an important impact on the cost of the

subscriber unit. Also, additional power supplies, like solar panels or batteries, might be required, which further escalates costs. The population density of new connections determines the number of subscribers per base station, which influences the cost of a base station per subscriber. The higher the cost of the base station per subscriber and subscriber equipment, the higher the deployment cost of a wireless telephone in the system.



**Figure 24. Causal Structure of Wired Technology in the Regional Telecommunications System**



**Figure 25. Causal Structure of Wireless Technologies in the Regional Telecommunications Systems**

### 7.3 Access Technologies Formulation

#### 7.3.1 Equations of Wired Access Network

The cost of the wired network per line (CWIRE) is the sum of the cost of external plant per line (CEXTP) and the cost of the core network per line (CCORE), which includes the switching office and backhaul connection costs. Subscript *i* refers to any of the two regions, urban (u) and rural (r):

$$CWIRE_i = CEXTP_i + CCORE_i \quad (65)$$

The cost of the external plant per line (CEXTP) is function of the average distance from the central office to the households (ADCTH), the cost per meter of cable (CMC), and a referential base cost (RBC), which is considered to be about \$ 150 (Kayani and Dymond 1997):

$$\text{CEXTP}_i = \text{RBC} + (\text{ADCTH}_i * \text{CMC}) \quad (66)$$

The average distance from the central office to the households (ADCTH) is function of the area of coverage of the central office (ARCCO), which assumes a circular shaped area. The area of coverage of the central office is function of the number of telephone lines per central office (NTLCO) and the number of telephone lines per area (NLPA):

$$\text{ADCTH}_i = \text{SQRT}(\text{ARCCO}_i / 2 * 3.1416) \quad (67)$$

$$\text{ARCCO}_i = \text{NTLCO} / \text{NLPA}$$

The number of lines per area (NLPA) is function of the normal number of lines per area (NNLPA) and the telephone lines-telephone density adequacy (TLTDA). The telephone lines-telephone density adequacy (TLTDA) is a non-linear function of the wired network telephone density (WNTD):

$$\text{NLPA}_i = \text{NNLPA}_i * \text{TLTDA}_i \quad (68)$$

$$\text{TLTDA}_i = f_{\gamma_i}(\text{WNTD}_i) \quad \text{Where } f'_{\gamma_i} < 0$$

The normal number of lines per area (NNLPA) is function of the population density (POPD) and the number of people per line (NUMPL), which depends on the number of lines per house (NUMLH) and the number of people per house (NUMPH):

$$\text{NNLPA}_i = \text{POPD}_i / \text{NUMPL}_i \quad (69)$$

$$\text{NUMPL}_i = \text{NUMPH}_i / \text{NUMLH}_i$$

The time to deploy a wired telephone line (TDWDL) is function of the time to install the switching equipment (TISW), the external plant deployment time (DTEXP), and the time to couple the external plant with the switching equipment (TCXPSW):

$$\text{TDWDL}_i = \text{TISW}_i + \text{DTEXP}_i + \text{TCXPSW}_i \quad (70)$$

The external plant deployment time (DTEXP) is function of the referential external plant deployment time (REXPDT) and the distance from the central office to the household ratio (DCOHR). It has been assumed that laying a external plant in a developing country with an urban population density of 284 people per square kilometers takes about one year:

$$\text{DTEXP}_i = \text{REXPDT}_i * \text{DCOHR}_i \quad (71)$$

The distance from the central office to the household ratio (DCOHR) is function of the average distance from the central office to the households (ADCTH) and a referential distance from the central office to the households (RDCTH):

$$\text{DCOHR}_i = \text{ADCTH}_i / \text{RDCTH}_i \quad (72)$$

### 7.3.2 Equations of Wireless Access Networks

The cost of a wireless telephone line (CWLH), which includes cellular and wireless local loop systems, is the sum of the cost of the base stations per line (CBSL), the cost of the core network per line (CCNL), and the cost of the subscriber stations per line (CSSL):

$$\text{CWLH}_i = \text{CBSL}_i + \text{CCNL}_i + \text{CSSL}_i \quad (73)$$

The cost of the base stations per line (CBSL) is equal to the cost of a base station (CABS) divided by the number of wireless lines per base station (WLBS):

$$\text{CBSL}_i = \text{CABS} / \text{WLBS}_i \quad (74)$$

The number of wireless lines per base station (WLBS) is a function of the area of the cell covered by the base station (ACBS), the number of wireless lines per area (NLA), the area of the cell indicated (ACBSI), the maximum area of the cell (MARC), and the maximum number of wireless lines per base station (MWLBS). The maximum area of the cell assumes a circular cell and is function of the maximum radius of the base station (MRAD). The area of the cell indicated (ACBSI) is function of the maximum number of wireless lines per base station (MXWLBS) and the number of wireless lines per area (NLA):

$$WLBS_i = ARC * NLA_i \quad (\text{If } ACBSI_i \geq MARC) \quad (75)$$

$$WLBS_i = MWLBS_i \quad (\text{If } ACBSI_i < MARC)$$

$$MARC = \pi * (MRAD)^2$$

$$ACBSI_i = MXWLBS_i * NLA_i$$

The area of the cell (ARC) is function of the maximum area of the cell (MARC) and the area of the cell indicated (ACBSI):

$$ARC_i = MARC \quad (\text{If } ACBSI_i \geq MARC) \quad (76)$$

$$ARC_i = ACBSI_i \quad (\text{If } ACBSI_i < MARC)$$

The cost of the subscriber stations per line (CSSL) is equal to the total cost of the subscriber equipment inside a base station (TCSEBS) divided by the number of wireless lines per base station (WLBS):

$$CSSL_i = TCSEBS_i / WLBS_i \quad (77)$$

The total cost of the subscriber equipment inside a base station (TCSEBS) is the sum of the total cost of special subscriber equipment in a base station (TCSPSE), the total cost of normal subscriber equipment in a base station (TCNSE), and the cost of extra power supply for subscriber units without access to electricity (CPS):

$$TCSEBS_i = TCSPSE_i + TCNSE_i + CPS_i \quad (78)$$

The total cost of special subscriber equipment in a base station (TCSPSE) is equal to the cost of special subscriber equipment (CSPSE) multiplied by the number of



wireless phones outside the normal area of a cell (WPONAC). The total cost of normal subscriber equipment in a base station (TCNSE) is equal to the cost of normal subscriber equipment (CNSE) multiplied by the number of wireless phones inside the normal area of a cell (WPINAC):

$$TCSPSE_i = CSPSE * WPONAC_i \quad (79)$$

$$TCNSE_i = CNSE * WPINAC_i$$

The number of wireless phones outside the normal area of the cell (WPONAC) is function of the number of wireless lines per area (NLA), the area of the cell (ARC), and the normal area of the cell (NARC). The number of wireless phones inside the normal area of the cell (WPINAC) is function of number of wireless lines per base station (WLBS) and the number of wireless phones outside the normal area of the cell (WPONAC). The normal area of the cell is a function of the normal radius of the base station (NRAD):

$$WPONAC_i = NLA_i * (ARC_i - NARC_i) \quad (\text{If } ARC_i > NARC_i) \quad (80)$$

$$WPONAC_i = 0 \quad (\text{If } ARC_i \leq NARC_i)$$

$$WPINAC_i = WLBS_i - WPONAC_i$$

$$NARC_i = \pi * (NRAD)^2$$

The cost of power supply of subscriber units without access to electricity in a base station (CPS) is function of the number of wireless phones per base station

(WLBS), the percentage of wireless phones without access to electricity (PWPWE), and the cost of each solar panel equipment per subscriber (CESPE):

$$CPS_i = WLBS_i * PWPWE_i * CESPE \quad (81)$$

The wireless phones outside the normal area of the cell in a wireless network require especial equipment in order to be able to connect to the base station. Additionally, the households with cellular phones outside the normal area of the cell will have their cellular equipment fixed or attached to the wall, which means a lack of mobility. For this reason, a higher number of households located outside the normal area of the cell translate into less mobility of the cellular system. In other words, the higher the number of households inside the normal area of the cell, the higher the mobility of the subscribers in the cellular network.

The average number of wireless phones inside the normal area of the cell (AWPINAC) and the average number of wireless phones per base station (AWLBS) determine the fraction of wireless phones in a base station with mobility (FWPWM). The AWPINAC and AWLBS are first order exponential averages of the number of wireless phones inside the normal area of the cell (WPINAC) and the number of wireless phones per base station (WLBS) respectively. These averaging processes use the time constant  $T_2$  and  $\mu^1$  is the first order exponential average:

$$FWPWM_i = AWPINAC_i / AWLBS_i \quad (82)$$

$$AWPINAC_i = \mu^1 [WPINAC_i, T_2]$$

$$AWLBS_i = \mu^1 [WLBS_i, T_2]$$

The fraction of mobile users in the system (FMUS) is a function of the postpaid connected subscribers (CS), the prepaid telephone subscribers ( $VASU_i^{PP}$ ), the total wireless subscribers (WSUB), and the fraction of wireless phones in a base station with mobility (FWPWM):

$$FMUS_i = WSUB_i * FWPWM_i / (CS_i + VASU_i^{PP}) \quad (83)$$

The total wireless subscribers (WSUB) is function of the postpaid service connecting rate (CR), the prepaid service connecting rate (PPCR), the postpaid service attrition rate (AR), and the prepaid service attrition rate ( $ARVAS_i^{PP}$ ):

$$(d/dt) WSUB_i = CR + PPCR - AR - ARVAS_i^{PP} \quad (84)$$

#### 7.4 Telephone Dispersion for Different Access Networks

In this section, I simulate the historical and future behavior of the growth of the cellular (Cellular #1) and conventional wired telephone networks in Ecuador, which is shown in Figures 26, 27, 28, 29, 30, and 31. In addition, two hypothetical cases, which consist on the implementation of Wireless Local Loop (WLL) and cellular networks (Cellular #2) by the telephone operator as a replacement of the wired access network in year 1993, are also simulated.

The simulations are calibrated for the case of Ecuador, which has an urban income per capita of 1,708 dollars and a rural income per capita of 310 dollars. In

addition, its urban population density is 284 people per square kilometer and its rural population density is nineteen people per square kilometer (World Development Indicators, 2002). In Figure 26, it is possible to observe the moment when the number of cellular phones surpassed the number of conventional telephone lines in year 2002. It is important to note that most of the implementation of the cellular network has been in urban regions.

The implementation of cellular systems in urban and rural areas involves the deployment of base stations that have a normal radius of coverage of five kilometers and an extended radius of coverage of thirty kilometers. The maximum number of subscribers supported by each base station is 5,000. The normal cost of each cellular base station is 150,000 dollars. In addition, the cost of a normal subscriber unit is fifty dollars, and the cost of a special subscriber unit, which is used outside the normal coverage of the base station, is 400 dollars. The normal subscriber unit is mobile since it can move inside the normal area covered by a base station, but the especial subscriber unit is fixed since it requires a special antenna attached to the wall of the house in order to communicate with the base station. The access to electricity in urban areas is ninety eight percent and in rural areas is fifty percent of the population. The cost of a solar panel, which is used to supply with electricity the subscriber equipment in each house without electricity, is 500 dollars. The license fee for cellular systems is assumed 50,000,000 dollars for a license period of fifteen years.

The implementation of WLL is similar to the cellular implementation. It considers the same level of access to electricity and the use of the same solar panels as

the cellular case. It involves the deployment of base stations, which have a normal radius of coverage of fifteen kilometers and an extended coverage of thirty-five kilometers. The maximum number of users supported by each base station is 5,000 households. The normal cost of each base station is 150,000 dollars; the cost of a normal subscriber unit is 400 dollars, and the cost of a special subscriber unit, which is used outside the normal coverage of the base station, is 600 dollars. The license fee for Wireless Local Loop has been set to 5,000,000 dollars for a license period of fifteen years.

The deployment of the cellular network has produced the fastest growth of telephones in urban and rural areas. It is observed in Figure 26 that the cellular network increased exponentially in urban areas, which represents the historical behavior observed in past years. The number of cellular subscribers keeps increasing exponentially until they achieve steady state growth, which is indicated by a linear growth. This situation is also observed in the hypothetical case in urban areas where the telecom operator decides to replace the wired access network by a cellular access network, as shown in Figure 26. The exponential growth of cellular phones is also observed in rural areas.

The number of urban and rural telephones is considerably improved by the implementation of the cellular network because it has the lowest cost per telephone and the lowest deployment delay in both regions, as observed in Figures 28, 30, 29, and 31. The improvement in the cost per telephone occurred in spite of the lack of electricity in rural areas, which increases the cost of the cellular subscriber equipment due to the need

of solar panels. In addition, the low rural population density requires the use of more expensive subscriber equipment, which is fixed to each house. Therefore, the improvement on the telephone deployment costs and implementation delays observed in cellular networks increase considerably the supply of urban and rural telephones, which increase the revenue and financial resources of the telecom company.

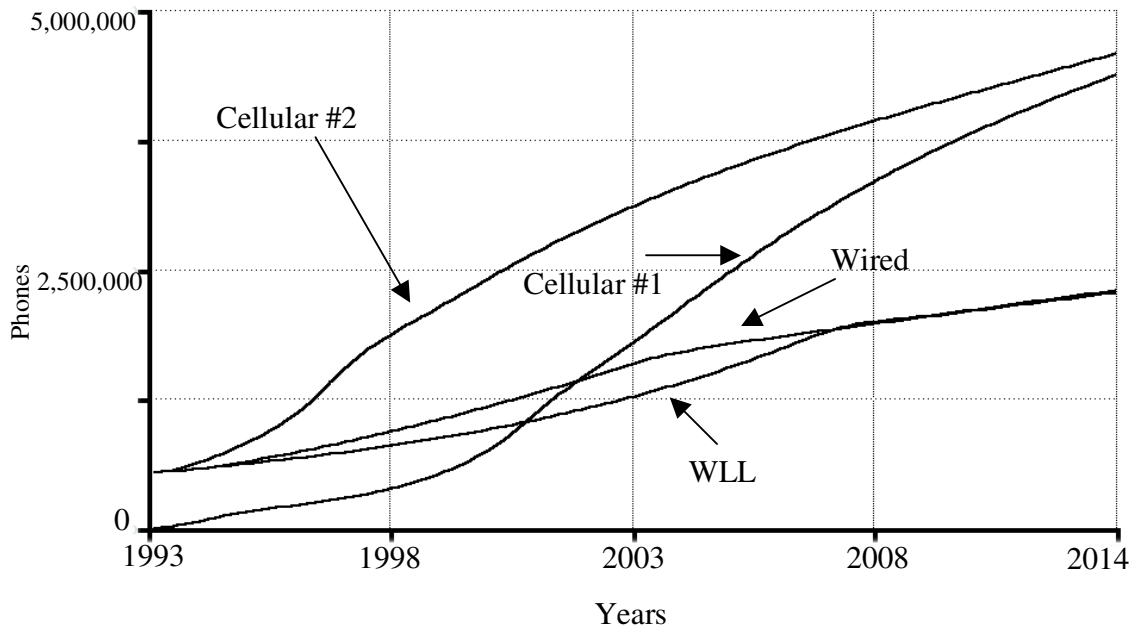
When the cellular system is implemented in the regional telecom system, the cellular subscribers increase the telephone density of the whole region. The higher the telephone density, the lower the population density of the new connected subscribers as shown by negative feedback loop 34 in Figure 25. The reduction of the population density of the new connected subscribers because of the growth of the telephone density increases the number of subscribers outside the normal area covered by a cellular base station, as shown by negative feedback loop 33 in Figure 25. This determines a higher number of subscribers requiring fixed antennas and especial equipment in order to connect to the base stations from home, which represents higher costs for the subscriber units. In addition, the low access to electricity is a major factor influencing the cost of the subscriber unit, which increases the cost of deploying a phone in the system.

The higher the number of subscribers with fixed antennas located outside the normal area covered by the base stations, the lower the number of subscribers with mobility in the cellular network, as shown by negative feedback loop 32 in Figure 25. The mobility and portability are characteristics of the cellular network that tend to increase the traffic of the network since the willingness to pay and usefulness of a telephone has been improved. This is also shown in negative feedback loop 32.

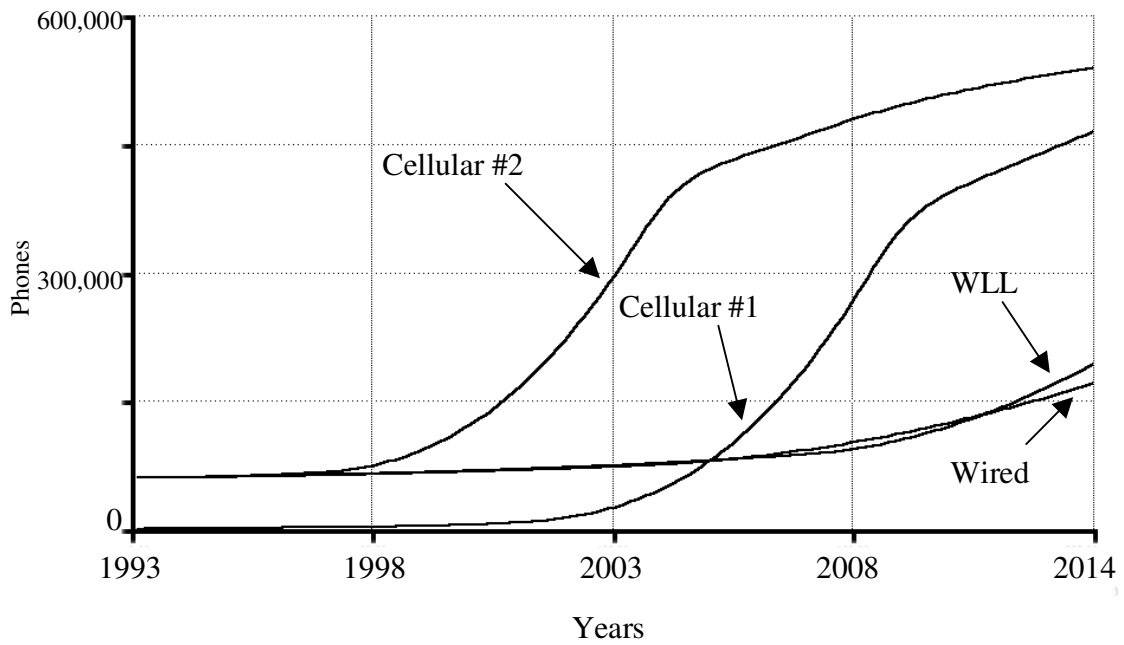
It is observed in Figure 27 that the hypothetical implementation of WLL slightly improves the number of rural telephone lines in the long run with respect to the conventional wired access network. This situation occurs because of the lower cost and lower implementation delay of the WLL system with respect to the conventional wired technology in rural areas, which is shown in Figures 29 and 31.

When the WLL technology is implemented in the regional telecom system, the new WLL subscribers increase the telephone density of the region. The higher the telephone density, the lower the population density of the new subscribers being connected which is shown by negative feedback loop 34 in Figure 25. In addition, the low access to electricity in developing countries is a major factor influencing the cost of the subscriber unit, as shown in negative feedback loop 33 of Figure 25. The higher the subscriber cost, the higher the cost of a WLL telephone line.

The growth of telephone lines in the conventional wired network also reduces the population density of the new connected subscribers as the telephone density of the region increases. This situation increases the distance between households as shown by negative feedback loop 30 in Figure 24, which considerably increases the deployment delay and the cost of a wired telephone line. The relatively high deployment delay and cost of a wired telephone line reduces the supply of new telephone lines and the number of connected households, as shown in negative feedback loops 30 and 31 of Figure 24. This behavior can also be observed in Table 14.

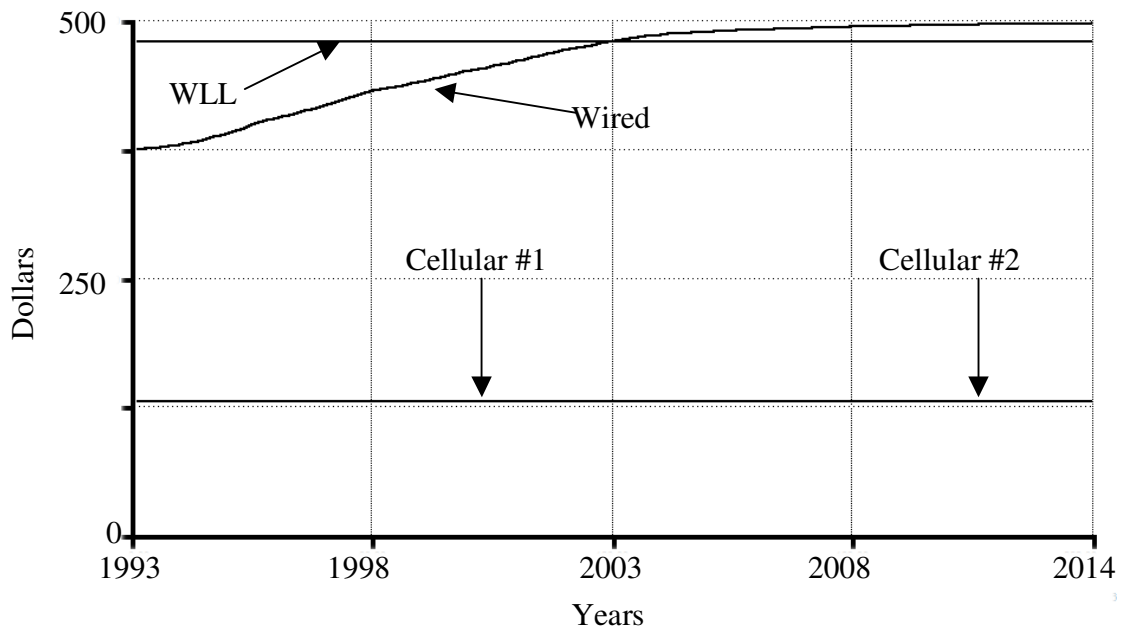


**Figure 26. Urban Phones for Different Access Networks**

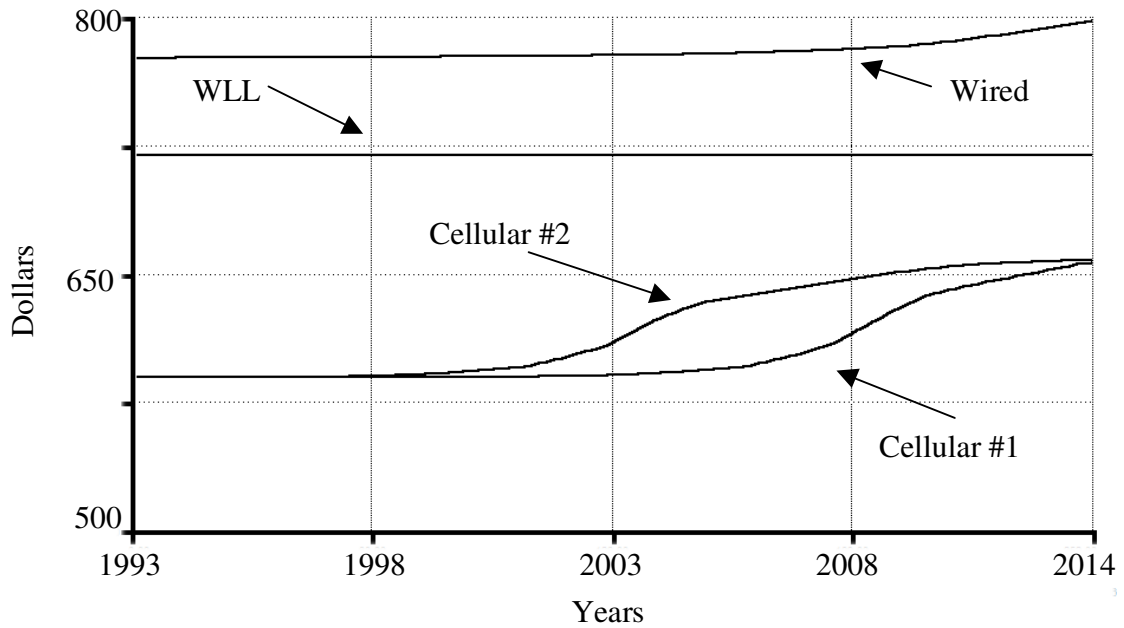


**Figure 27. Rural Phones for Different Access Networks**

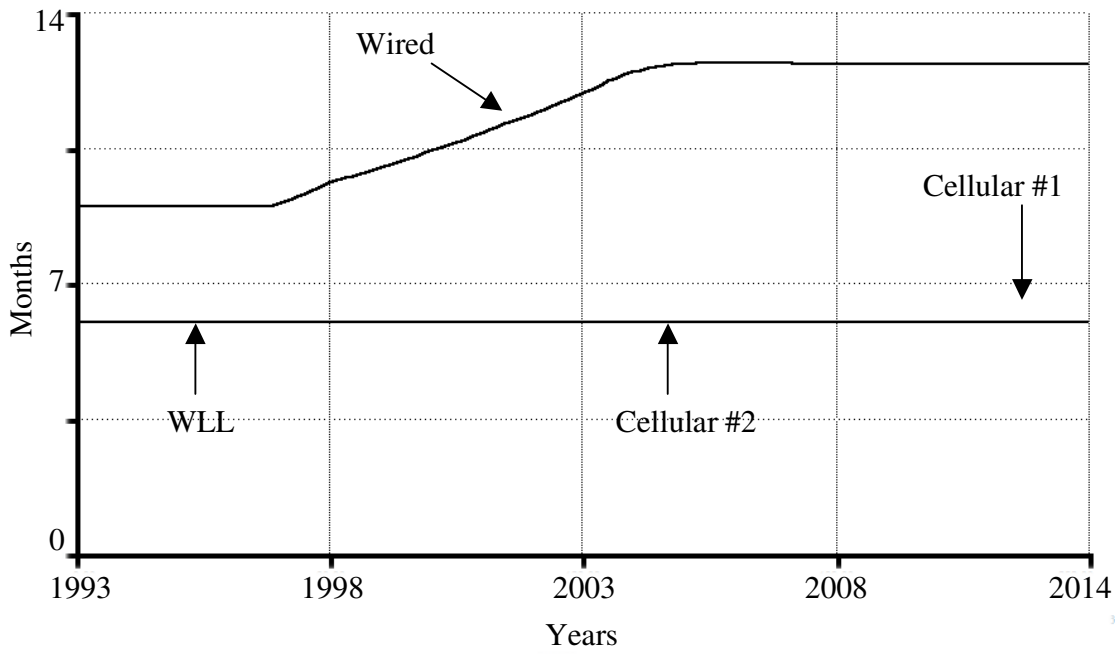




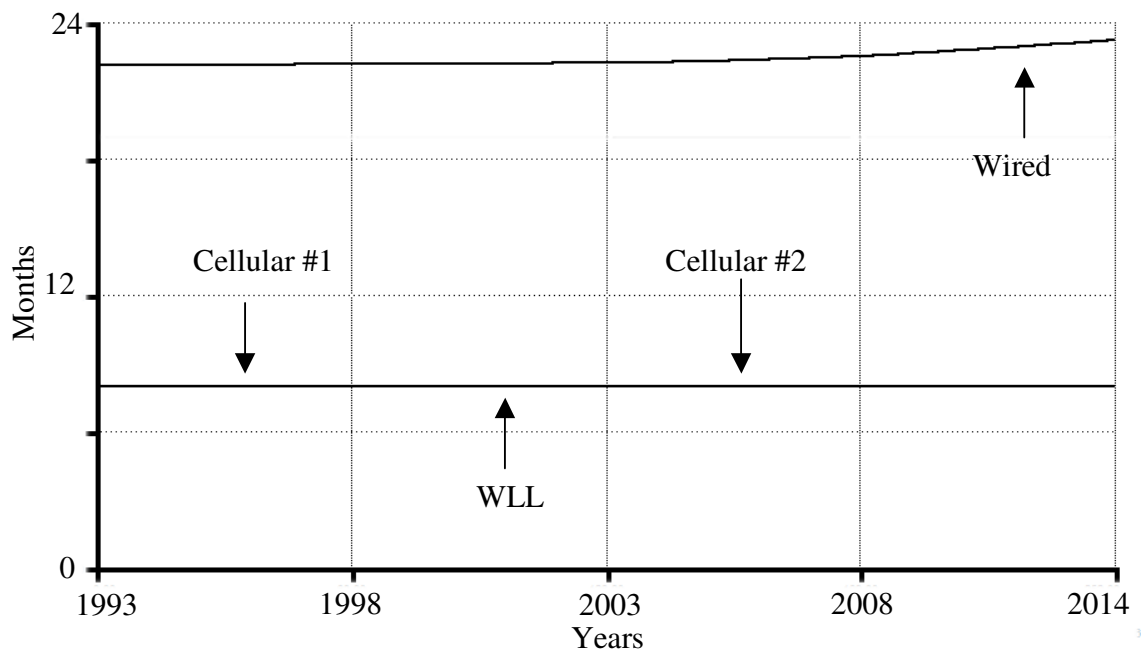
**Figure 28. Urban Cost for Different Access Networks**



**Figure 29. Rural Cost for Different Access Networks**



**Figure 30. Urban Delay for Different Access Networks**



**Figure 31. Rural Delay for Different Access Networks**

Technology	Telecom Indicators	Years		
		1993	2003	2014
1. Cellular #1	Urban Phones (Phones)	0	1,656,907	4,338,018
	Rural Phones (Phones)	0	19,192	465,241
	Urban Cost (Dollars)	130	130	130
	Rural Cost (Dollars)	589	591	657
	Urban Delay (Months)	6	6	6
	Rural Delay (Months)	8	8	8
2. Wired	Urban Phones (Phones)	538,418	1,529,822	2,280,357
	Rural Phones (Phones)	59,829	71,814	170,910
	Urban Cost (Dollars)	376	477	498
	Rural Cost (Dollars)	777	778	799
	Urban Delay (Months)	9	11	12
	Rural Delay (Months)	22	22	23
3. WLL	Urban Phones (Phones)	538,418	1,220,959	2,299,933
	Rural Phones (Phones)	59,829	73,456	193,268
	Urban Cost (Dollars)	480	480	480
	Rural Cost (Dollars)	720	720	720
	Urban Delay (Months)	6	6	6
	Rural Delay (Months)	8	8	8
4. Cellular #2	Urban Phones (Phones)	538,418	3,027,613	4,592,831
	Rural Phones (Phones)	59,829	262,337	539,896
	Urban Cost (Dollars)	130	130	130
	Rural Cost (Dollars)	589	606	658
	Urban Delay (Months)	6	6	6
	Rural Delay (Months)	8	8	8

Table 14. Performance of Different Access Technologies

## 7.5 Base Case Values

<b>Model Parameters</b>	<b>Base Case</b>
1. Monthly Rental Fee (Urban and Rural)	\$1
2. Urban Income per Capita	\$1708
3. Rural Income per Capita	\$310
4. Total Connected Subscribers Initial	598,287
5. Percent. Rural Lines	1 %
6. ITU Waiting List	30,000
7. Waiting List Unreported Factor	4
8. Initial Population	11,000,000
9. % Rural Population	40%
10. Urban Population Growth Rate	2.3%
11. Rural Population Growth Rate	0.2%
12. Number of Telephones per Urban House	1
13. Number of Telephones per Rural House	1
14. Initial Cash Balance	\$30 Millions
15. Investment in Rural Areas	3.5%
16. Delay to Accept Activation Fee	3 mo.
17. Wireless Flag (urban and rural)	0
18. License Cost	\$ 0
19. Activation Fee (Urban)	\$ 76
20. Activation Fee (Rural)	\$ 22
21. Price of International Traffic per Minute	\$ 1
22. Time to Recognize Attractiveness	6 mo.
23. Time to Adjust Demand (Urban and Rural)	60 mo.
24. Incoming-Outgoing International Traffic Ratio	3
25. Delay to Adjust Lines (Urban and Rural)	3 mo.
26. Initial Telephones to Connect (Urban)	10,000
27. Initial Telephones to Connect (Rural)	100
28. Regional Fraction Waiting List (Urban)	0.9

29. Regional Fraction Waiting List (Rural)	0.1
30. Fraction of Telephone Capacity per Month	0.25
31. License Duration	15 years
32. Free Local Minutes (Urban and Rural)	100 min
33. Fraction of Cap Cost as part of Op. Cost	0.3
34. Urban Weight on Externality (Urban)	0.9
35. Urban Weight on Externality (Rural)	0.5
36. Rural Weight on Externality (Urban)	0.1
37. Rural Weight on Externality (Rural)	0.5
38. Free Local Minutes Used (Urban)	100
39. Free Local Minutes Used (Rural)	50
40. Expenditure on Traffic as Fr. of Income (Urb)	0.01
41. Expenditure on Traffic as Fr. of Income (Rur)	0.006
42. Fraction of Expenditure on Telecom (Urban)	0.015
43. Fraction of Expenditure on Telecom (Rural)	0.015
44. Number of People per House	4
45. Cost of the Core Network per Line	\$ 40
46. Time to Install Switching Equipment (Urban)	8 mo.
47. Time to Install Switching Equipment (Rural)	18 mo.
48. Time to Couple Ext. Plant with Switch. Equip.	1 mo.
49. Referential Ext. Plant Deployment Time	12 mo.
50. Referential Population Density	284
51. Number of Lines per Central Office	5,000
52. Referential Cost of External Plant	\$ 150
53. Population Density (Urban)	284
54. Population Density (Rural)	19
55. Referential Cost per Meter of Cable	\$ 0.1
56. Cost of Base Station	\$ 150,000
57. Cost of Solar Panel	\$ 500
58. Cost of Normal Subscriber Unit	\$ 50

59. Cost of Special Subscriber Unit	\$ 400
60. Access to Electricity (Urban)	0.98
61. Access to Electricity (Rural)	0.5
62. Maximum Radio of the Cell	30 km
63. Normal Radio of the Cell	5 k5
64. Maximum Wireless Lines per Base Station	5,000

**Table 15. Base Case values of the Access Technologies Analysis**

### **7.6 Sensitivity Analysis of Different Access Technologies**

The preceding section showed how cellular technologies were able to considerably improve the number of telephones in urban and rural areas of Ecuador. New experiments were conducted to test the sensitivity of the cellular system and other access technologies to changes in population densities. The population densities were reduced from 284 people per square kilometer to seventeen people per square kilometer in urban areas, and from nineteen people per square kilometer to two people per square kilometer in rural areas. The simulation results of the sensitivity analysis are shown in Table 16.

It is observed that a lower population density reduces the impact of the cellular technology in the regional telecom system, but this technology is still able to increase the number of phones in urban and rural areas when compared with the conventional wired technology. This situation is observed in the hypothetical case when the cellular access network is implemented as a replacement of the wired external plant, which is indicated by technologies 1 and 4 in Table 16. However, it is observed that WLL

provides the best performance in urban and rural regions under this new scenario. This happens due to the larger coverage of the WLL cell with respect to the cellular cell, which reduces the cost. The larger radio of coverage per base station requires a lower number of special and more expensive equipment required to connect the subscriber with the base station in areas outside the normal coverage. It is also observed that the cellular system improves the number of urban telephone lines in the very long run, for its hypothetical case.

		Years				
Technology	Telecom Indicators	1993	1998	2003	2008	2014
1. Cellular #1	Urban Phones	0	86,675	111,651	162,828	276,715
	Rural Phones	0	965	1,231	1,777	2,999
	Urban Cost	246	249	249	250	252
	Rural Cost	706	706	706	706	706
	Urban Delay	6	6	6	6	6
	Rural Delay	8	8	8	8	8
	2. Wired	Urban Phones	538,458	548,448	548,784	548,940
Rural Phones		59,829	56,236	46,142	33,420	21,671
Urban Cost		648	606	569	546	530
Rural Cost		1,338	1,335	1,329	1,322	1,316
Urban Delay		91	85	78	76	74
Rural Delay		195	194	193	192	191
3. WLL		Urban Phones	538,458	776,121	1,307,627	1,602,804
	Rural Phones	59,829	63,860	73,048	112,214	181,203
	Urban Cost	480	480	519	531	531
	Rural Cost	853	853	854	856	862
	Urban Delay	6	6	6	6	6
	Rural Delay	8	8	8	8	8
	4. Cellular #2	Urban Phones	538,458	733,486	1,011,228	1,543,091
Rural Phones		59,829	62,128	65,512	72,481	88,396
Urban Cost		272	280	295	329	387
Rural Cost		707	707	707	707	707
Urban Delay		6	6	6	6	6
Rural Delay		8	8	8	8	8

**Table 16. Performance of Different Access Technologies for a Thinly Populated Country**

The reduction in the population densities increased the operating costs and deployment delays of the telephone company for wireless and wired access network technologies. However, the sensitivity analysis of the equipment, material, and labor costs used in this investigation are left for future research.



## **7.7 Conclusions**

This chapter presents an investigation about the use of three different access technologies: wired access networks, Wireless Local Loop, and cellular systems. The wireless technologies were able to considerably improve the regional dispersion of telephone services.

There is no specific access technology that provides the best performance for every type of environment. For instance, Wireless Local Loop was found the best technology for improving the number of urban and rural telephones in a thinly populated country. On the other hand, the cellular system implementation showed the best performance for the specific case of Ecuador because of the lower deployment delays and lower implementation costs in both urban and rural regions.

It is important to note that developing countries have experienced a low level of implementation of Wireless Local Loop services in past years. However, this investigation found that WLL could be a viable alternative in spite of its relative high cost, especially in low-density countries, where the cost of wired systems increases and the low deployment delay and relatively large coverage of WLL systems become crucial factors on the dispersion of telephone services.

An important aspect observed in the analysis of this investigation was the impact of deployment delay on the dispersion of telephone services. It was observed to be a very important factor for increasing the number of telephone lines in developing countries.

## **Chapter 8. Research Contribution and Conclusion**

### **8.1 Practical Applications**

This dissertation has a practical application in the telecommunications industry besides its contribution to policy design for expansion of telecom services. The telecom regulatory authorities, telecom operators, and telecom manufacturers, could find this dissertation useful for different purposes.

This dissertation could be helpful for telecom regulatory authorities and telecom operators of developing countries. These entities could clearly understand the implications of Universal Service Obligations and International Cross Subsidies on the dispersion of telephone services. Since these subsidies were shown to be counterproductive, telecom regulatory authorities have a useful tool that can be used to support their decisions when making complex deliberations regarding telephone subsidy policies and regulations. On the other hand, telephone operators and regulators will find in this document a detailed analysis of telephone pricing mechanisms that can make a positive impact on telephone dispersion, such as market and prepaid pricing.

The combination of prepaid payphone, virtual telephony, and phone services was found to improve the telephone density. Telecom operators could implement this service combination in order to increase their financial resources and telephone infrastructure both in urban and rural areas. They could pay more attention to the availability of payphones and other types of infrastructure described in this work for rural areas, since this was regarded as a crucial factor for the success of this implementation.

The impact of wireless technologies in low density regions was covered in this investigation. Telecom operators will have a better understanding of the functioning of these technologies and their suitability for rural telephone deployment.

The manufacturers of telecom equipment could also find this investigation useful, so they can focus on improving the user interface of several telecom equipments and systems such as mailboxes, calling cards, and payphones. This investigation emphasized that the friendliness of this interface was crucial for the adoption of different value added services in the regional telecom system.

## **8.2 Counterintuitive Policies and Counterproductive Telecom Systems**

As a result of this investigation two counterintuitive telecommunications policies were found. The Universal Service Obligations are intended to create positive network externalities that are able to improve the telephone dispersion in developing countries. This increases the number of rural telephone lines in the short run but reduces it in the long run. In addition, the total number of urban and rural telephone lines is reduced since the financial resources of the telephone company are also decreased. This behavior occurs, because a higher investment in rural areas reduces the investment in more profitable urban areas, which decreases the financial resources in the long run, reducing both urban and rural telephone lines.

The second counterintuitive telecommunications policy is the application of International Cross-Subsidies. This policy reduces the monthly rental fee of the telephone service in order to increase its demand and the number of telephone lines in

urban and rural regions. However, it was observed in the model experiments that the reduction of the monthly rental fee reduces the financial resources of the telephone company, which are needed for the supply of new telephone lines in developing countries. These countries are characterized for having a large unsatisfied demand and waiting list of telecom services.

Cellular systems are considered the best technology currently on the market that is able to accelerate the dispersion of telecom services in developing countries. However, it was found that in thinly populated countries the Wireless Local Loop systems could outperform cellular systems. This occurs due to the larger coverage of the WLL system with respect to the cellular technology. This situation reduces the cost of the base station per subscriber in scattered and rural regions.

### **8.3 New Policies Found**

There are several new policies that were found as a result of my investigation. Most significantly, market clearing pricing was found to be important for improving the regional dispersion of telephone services in developing countries. The market pricing mechanism increases the urban monthly rental fee when the ratio between the supply of telephone capacity and the demanded telephone capacity is lower than one.

The combination of market clearing pricing with Universal Service Obligations was also another important policy recommended in this dissertation. This increases the Universal Service Obligations only after the urban telephone density reaches about forty percent. This level of connectivity occurs when the supply of telephone capacity in

urban areas equals the demanded telephone capacity using a market-clearing pricing mechanism.

The prepaid pricing mechanism was found to have a positive impact on telecom systems, since this depends on the willingness to pay of the subscribers. The adoption of telephone services is expedited using this prepaid scheme, since complex paper work is bypassed and the commitment to pay a monthly rental fee is not necessary any more. This mechanism could be exploited positively by combining services that enhance the willingness to pay, which depends on the network externality of the system.

#### **8.4 Value Added Service Strategy Proposed**

This investigation also identified the causal structure of different telephone services that use value added infrastructure. The simulations showed a moderate impact of these services when implemented in isolation. However, if these services are implemented together they are able to trigger some key positive feedback loops, which improve the telephone density in developing countries.

The prepaid payphone, virtual telephony, and phone services implemented together enhances the network externality impact by expanding the number of people connected to the system. The network externality improvement increases the willingness to pay for telephone services and the prepaid and postpaid telephone demand. The improvement on the telephone service willingness to pay expands the expenditure on prepaid virtual telephony, payphone, and telephone services. This situation increases the revenue and financial resources of the telephone company. The

enhanced prepaid and postpaid telephone demand improves the number of prepaid and postpaid telephone subscribers in the network. This expands the financial resources of the telephone company.

### **8.5 Application to the Dispersion of other Services in Developing Countries.**

It is important to note that this dissertation is about the regional dispersion of telephone services in developing countries, but the basic causal structure of the regional telecommunications system can be adapted to other types of services such as electricity, potable water, transportation, and gas, among others.

The economic, cultural, and social differences between urban and rural regions have a significant impact on the dispersion of services in developing countries. These differences are emphasized in the structure of the regional telecom system described in this dissertation and remain in the implementation of other regional services. In addition, these public services present similar cross-subsidies than the presented in this investigation, and some pricing mechanisms studied here could also be adapted to these services.

In the case of electric power service, urban areas have a significantly higher consumption of electricity than rural areas. The cost of providing electric service in rural areas will be higher than the provision in urban areas, because of the lower population density in rural areas, and the lack of complementary infrastructure. Finally, the revenue from urban electric service is higher than in the rural case, not only because of the higher level of consumption but also because of the higher prices paid in urban

regions. The same analogy can be developed to other types of services in developing countries.

## **8.6 Conclusion**

The conclusions of the research of this dissertation are summarized below:

1. The Universal Service Obligation and the International Cross-Subsidy policies are counterproductive because of the dynamic structure of the regional telecom system.
2. The market-clearing pricing was able to considerably improve the number of rural and urban telephone lines and the financial resources of the telecom company.
3. The implementation of market-clearing pricing with the Universal Service Obligation policy after the urban telephone density reaches forty percent, when the supply of urban telephone capacity equals the demanded capacity, produces a considerable increase of rural telephone density.
4. The prepaid phone, virtual telephony, and payphone services, which are innovative services over the telephone network, are able to considerably improve the financial resources of the telephone company and accelerate the dispersion of telephone lines in rural areas of developing countries, only when implemented together.
5. The wireless technologies were able to considerably improve the regional dispersion of telephone services. Wireless Local Loop was found the best

technology for improving the number of urban and rural telephones in a thinly populated country.

## **8.7 Future Work**

More research is needed in order to identify new technological strategies that could improve the regional dispersion of telephone services in developing countries. For instance, the deployment of telephone services through power lines and the combination of several technologies such as satellite, wired, and cellular systems. A further analysis of value added services is required since new innovative solutions could make a difference on improving the financial resources of the telecom company and increasing the telephone dispersion.

The actual implementation and application of the new policies and service strategies found in this dissertation is very important as a further validation step of this investigation. The final conclusion will be drawn after observing the actual behavior of the system in real life.

The impact of quality of service on the dispersion of telecom services is an important issue than needs to be investigated as part of a future work. This is the impact of quality of service on wireless systems such as Wireless Local Loop and value added services such as virtual telephony.

The study of the impact of cellular phones on social and economic development using a System Dynamics approach is strongly recommended as a future research. This is how cellular phones can affect the welfare of the population and their income per



capita through their contribution in businesses, commerce, security, and health, among others.

The study of the dispersion of new telecom services besides telephony, such as Internet and Cable TV, in developing countries is also necessary, since the gap in the regional dispersion of these services is also increasing with the time.

Last, but not least, the generic structure of the model of this thesis can be extended to explore the policies addressing other types of infrastructure, such as electricity, water supply, health and education services, and transportation networks. Further work focusing on specific agendas for different infrastructures should be pursued.

## **Bibliography**

Andrew TN., Petkov D. 2003. The need for a systems thinking approach to the planning of rural telecommunications infrastructure. *Telecommunications Policy* **27**: 75-93.

Bangladesh Bureau of Statistics ([www.bbsgov.org](http://www.bbsgov.org))

Barendse A. 2004. Innovative regulatory and policy initiatives at increasing ICT connectivity in South Africa. *Telematics and Informatics* **21**: 49-66.

Beal JC. 1976. A Multidisciplinary Investigation of the Application of Dynamic Modeling to the Study of Telecommunications Development in Canada. *IEEE Transactions on Engineering Management* **23** (2).

Bui T and Loebbecke C. 1996. Supporting cognitive feedback using system dynamics: A demand model of the global system of mobile telecommunication, *Decision Support Systems* **17(2)**: 83-98.

Brady A. 1999. Formulating strategies for a competitive telecommunications market. *38th European Telecommunications Congress 'Networking the Future'*, Utrecht, Netherlands.

Cain P, Macdonald JM. 1991. Telephone Pricing Structures: The Effects on Universal Service. *Journal of Regulatory Economics* **3**: 293-308.

Calhoun G. 1992. *Wireless Access and the Local Telephone Network*. Norwood, MA: Artech House, Inc.

Clarke GR, Wallsten SJ. 2002. *Universal(ly Bad) Service: Providing Infrastructure Services to Rural and Poor Urban Consumers*. World Bank Policy Research Working Paper 2868, Washington D.C.: The World Bank.

Clarkstone AD, Mrazek BE, Dymond AC. 1990. Rural Telecommunications Development in Botswana: Socio-Economic & Strategic Issues. *Second International Conference on Rural Telecommunications*, October 29-31 1990: 42-46.

Crandall RW, Waverman L. 2000. *Who Pays for Universal Service? When Telephone Subsidies Become Transparent*. Brookings Institution Press: Washington, D.C.

Cronin FJ, Colleran E, Miller M, Raczkowski. 1997. Local exchange competition, rate restructuring, and universal service. *Telecommunications Policy* **21**(3): 75-93.

Department of Telecommunications of India ([www.dotindia.com](http://www.dotindia.com))

Duckworth M. 2004. Universal Service in the 21st century. *ITU TELECOM ASIA 2004*, On-Line News Service, Sep 11, 2004. ([www.itudaily.com/new/home.asp?articleid=4091103](http://www.itudaily.com/new/home.asp?articleid=4091103)).

Dutta, A. and Roy, R. 2003. Anticipating Internet Diffusion. *Communications of the ACM* **46** (2).

Finance, Private Sector, and Infrastructure Development of World Bank. 2001. *Power and Communications Sectors Modernization and Rural Services in Ecuador Project (PROMECA)*. Report No. 22519-EC. Washington DC: The World Bank.

Fink C, Mattoo A, Rathindran R. 2002. *An assessment of telecommunications reform in developing countries*. World Bank Policy Research Working Paper 2909. The World Bank: Washington DC.

Flament M, Gessler F, Lagergren F, Queseth O, Stridh R, Unbehaun M, Wu J, Zander J. 1999. An approach to 4th generation wireless infrastructures – scenarios and key research issues. *49th IEEE Vehicular Technology Conference*, 16-20 May 1999 (2): 1742-1746.

Frete-Cibils V, Giugale MM, Lopez-Calix JR. 2003. *Ecuador: an economic and social agenda in the new millennium*. The World Bank: Washington DC.

Gasmi F, Laffont JJ, Sharkey WW. 2000. Competition, universal service and telecommunications policy in developing countries. *Information Economics and Policy* **12**: 221-248.

GAS 5 Economic Studies at the National Level in the Field of Telecommunications. 1984. *Optimum allocation and use of scarce resources in order to meet telecommunication needs in urban and rural areas of a country*. International Telecommunications Union: Geneva.

Gillwald A. 2005. Good intentions, poor outcomes: Telecommunications reform in South Africa. *Telecommunications Policy* **29**: 469-491

Goldschmidt D. 1987. *An Analysis of Costs and Revenues of Rural Telecommunications Systems*. The AID Rural Satellite Program. Produced by The Academy for Educational Development.

Goussal DM, Udrizar MS. 2000. Network decompensation and regional imbalances in rate reform processes: a case study in South America. *Telecommunications Policy* **24**: 669-698.

Gruber H. 2001. Competition and innovation. The diffusion of mobile telecommunications in Central and Eastern Europe. *Information Economics and Policy* **13**: 19-34.

Hamersma B. 1996. Implementing telecommunications value added services to achieve universal service objectives in Africa. *IEEE AFRICON '96* 24-27 September 1996 (2): 804-809.

Hamilton J. 2003. Are main lines and mobile phones substitutes or complements? Evidence from Africa. *Telecommunications Policy* **27**: 109-133

Hank I, McCarthy T. 2000. *Telecommunications Regulation Handbook*, InfoDev, The World Bank: Washington DC.

Hodge J. 2004. Universal Service through roll-out targets and license conditions: Lessons from telecommunications in South Africa. *Development Southern Africa* **21**(1) Special Issue March 2004.

Hodge J. 2005. Tariff structures and access substitution of mobile cellular for fixed line in South Africa. *Telecommunications Policy* **29**: 493-505

Hudson HE. 1984. *When Telephones Reach the Village. The Role of Telecommunications in Rural Development*. Ablex Publishing Corporation: Norwood, New Jersey.

Iñiguez H. 2005. Data provided by Holguer Iñiguez, Manager of Regulatory Affairs, Pacifictel S. A. ([www.pacifictel.net](http://www.pacifictel.net)) in January 2005.

- International Cooperation Planning Department of ITU Association of Japan, Inc., and Japan International Cooperation Agency. 2004. *Development of Rural Telecommunications*. ITU Association of Japan: Tokio.
- Jensen K, Trill S, Brady A. 2002. Dynamic Modelling of Demand and Supply in Telecommunications. *The Journal of The Communications Network* **1**(3): 52-58.
- Kayani R, Dymond A. 1997. *Options for Rural Telecommunications Development*. World Bank Technical Paper No. 359. The World Bank: Washington DC.
- Laffont JJ, N'Gbo A. 2000. Cross-subsidies and network expansion in developing countries. *European Economic Review* **44**: 797-805
- Littlechild S.C. 1979. *Elements of Telecommunications Economics*. Institution of Electrical Engineers (IEE).
- Lyons MH, Burton F, Egan B, Lynch T, Skelton S. 1997. Dynamic Modeling of Present and Future Service Demand. *Proceedings of the IEEE* **85** (10).
- Lyneis JM. 1980. *Corporate Planning and Policy Design*. The MIT Press: Cambridge, MA, and London, England.
- Lyneis JM. 1994. Tactical vs. Strategic approaches to competitive positioning - an example from the telecommunications industry. *1994 International System Dynamics Conference*, Sterling, Scotland, System Dynamics Society.
- Macías V. 2005. Data provided by Vicenta Macías, Manager of Intelligent Network Platform, Pacifictel S. A. ([www.pacifictel.net](http://www.pacifictel.net)) in January 2005.
- Makhaya G, Roberts S. 2003. Telecommunications in Developing Countries: reflection from the South African experience. *Telecommunications Policy* **27**: 41-59

- Malecki EJ. 2003. Digital development in rural areas: potential and pitfalls. *Journal of Rural Studies* **19**: 201-214
- Madden G, Coble-Neal G, Dalzell B. 2004. A dynamic model of mobile telephony subscription incorporating a network effect. *Telecommunications Policy* **28**: 133-144.
- Mannisto H, Tuisku K. 1994. Cost Comparison of Wireline and Wireless Access for the Public Switched Telephone Network. *IEEE ICPWC'94 IEEE International Conference on Personal Wireless Communications* 18- 19 August 1994: 37-39
- Mbarika VW. 2001. *Africa's Least Developed Countries' Teledensity Problems and Strategies. Telecommunications Stakeholders Speak*. M.E. & AGWECAMS Publishers: Yaoundé, Cameroon.
- Meadows DH. 1980. *The unavoidable a priori*, in Randers, J. (ed.), *Elements of the System Dynamics Method*. Pegasus Communications: Waltham, MA.
- Melody WH. 1999. Telecom reform: progress and prospects. *Telecommunications Policy* **23**: 7-34
- Milne C. 2003. *Measuring Affordability of Telecoms*. World Telecom/ICT Indicators Meeting, January 15-17 2003, International Telecommunications Union: Geneva, [http://www.itu.int/ITU-D/ict/WICT02/doc/pdf/Doc30\\_Erev1.pdf](http://www.itu.int/ITU-D/ict/WICT02/doc/pdf/Doc30_Erev1.pdf).
- Nepal Telecommunications Authority. 2004. Telecommunications Policy, [http://www.nta.gov.np/telecom\\_policy\\_2060.htm](http://www.nta.gov.np/telecom_policy_2060.htm)
- Noerpel AR. 1997. WLL: Wireless Local Loop – Alternative Technologies. *The 8th IEEE International Symposium on Personal, Indoor and Mobile Radio Communications* 1-4 September 1997 (2): 619-623.

OSIPTEL of Peru ([www.osiptel.gob.pe](http://www.osiptel.gob.pe))

Oliva R, Sterman JD, Giese M. 2003. Limits to growth in the new economy: exploring the 'get big fast' strategy in e-commerce. *System Dynamics Review* **19** (2): 83-117

Pahlavan K, Krishnamurthy P. 2002. *Principles of Wireless Networks. A Unified Approach*. Prentice Hall PTR: Upper Saddle River, New Jersey.

Peha JM. 1999. Tradable Universal Service Obligations. *Telecommunications Policy* **23**: 363-374.

Plaza JL. 2005. Data provided by José L. Plaza, Manager of External Plant, Pacifictel S. A. ([www.pacifictel.net](http://www.pacifictel.net)) in January 2005.

Primo CA, Forestier E, Stern PA. 1999. *Developing Countries and Accounting Rates Reform-A Technological and Regulatory El Niño?* The World Bank Group. Finance, Private Sector, and Infrastructure Network: Washington DC.

Ramos B, Gerstenfeld A. 2004. Planning Rural Telecommunications in Developing Countries and its Impact on the Increase of Rural Teledensity. *The International Journal of Business Disciplines* **15**(1): 47-63.

Ramos B, Saeed K, Pavlov O. 2005. The Impact of Universal Service Obligations and International Cross-Subsidies on the Dispersion of Telephone Services in Developing Countries Submitted to the Socio-Economic Planning Sciences Journal.

Robledo C, Arathoon L. 2002. Ecuador: WLL Auctions Kicks Off Market Liberalization. *Pyramid Perspective* 30 July 2002: 1-5

Ros AJ, Banerjee A. 2000. Telecommunications privatization and tariff rebalancing: evidence from Latin America. *Telecommunications Policy* **24**: 233-252.



Rycroft MG. 1998. The Provision of Power for Wireless Local Loop Systems in Developing Areas. *The 20th International Telecommunications Energy Conference* 4-8 October 1998: 61-65.

Saeed K. 1994. *Development Planning and Policy Design: a system dynamics approach*. Ashgate Publishing Company: England.

Saeed K, Honggang X. 2004. Infrastructure Development as a Policy Lever for Sustainable Development. In M. Quaddus and A. Siddique (Eds) *A Handbook of Sustainable Development Planning: Studies in Modelling and Decision Support*, Edward Elgar Publishers: Cheltenham, UK, and Northampton, Mass.

Saunders RJ, Warford JJ, Wellenius B. 1994. *Telecommunications and Economic Development (2nd ed.)*. John Hopkins University Press: Baltimore, MD.

Shapiro C, Varian HR. 1999. *Information Rules. A Strategic Guide to the Network Economy*. Harvard Business School Press: Boston, MA.

Siochru SO. 1996. *Telecommunications and Universal Service. International Experience in the Context of South African Policy Reform*. International Development Research Centre: Ottawa, Canada.

Sterman JD. 2000. *Business Dynamics*, McGraw-Hill

Strover S. 2003. The prospects for broadband deployment in rural America. *Government Information Quarterly* **20**: 95-106.

Superintendencia de Telecomunicaciones de Bolivia ([www.sittel.gov.bo](http://www.sittel.gov.bo))

The International Telegraph and Telephone Consultative Committee of ITU. 1985. *Rural Telecommunications*. International Telecommunication Union: Geneva.

The ITU Secretariat. 1998. *Methodological Note on Universal Service Obligations*. Note by the ITU Secretariat, 9<sup>th</sup> October 1998. <http://www.itu.int/osg/spu/intset/focus/usos3.pdf>

The ITU-D Focus Group 7. 2000. *New Technologies for Rural Applications*. Final Report of ITU-D Focus Group 7. The International Telecommunications Union: Geneva.

The Sun News On-Line. 2004. *Telecommunications Service Universality Concepts*, <http://www.sunnewsonline.com/webpages/features/cybersun/2004/mar/08/cybersun-mar8-006.htm>

The Telecommunications Development Bureau of ITU, and CITELE. 2000. *Telecommunications Policies for the Americas*, Blue Book. International Telecommunication Union: Geneva.

Thorner J. 1994. *Intelligent Networks*. Artech House, Inc: Norwood, MA.

Unbehaun M. 2002. *On the Deployment of Unlicensed Wireless Infrastructure*. Doctoral Dissertation, Royal Institute of Technology.

Wallsten SJ. 1999. *An empirical analysis of competition, privatization, and regulation in Africa and Latin America*. Mimeo, World Bank.

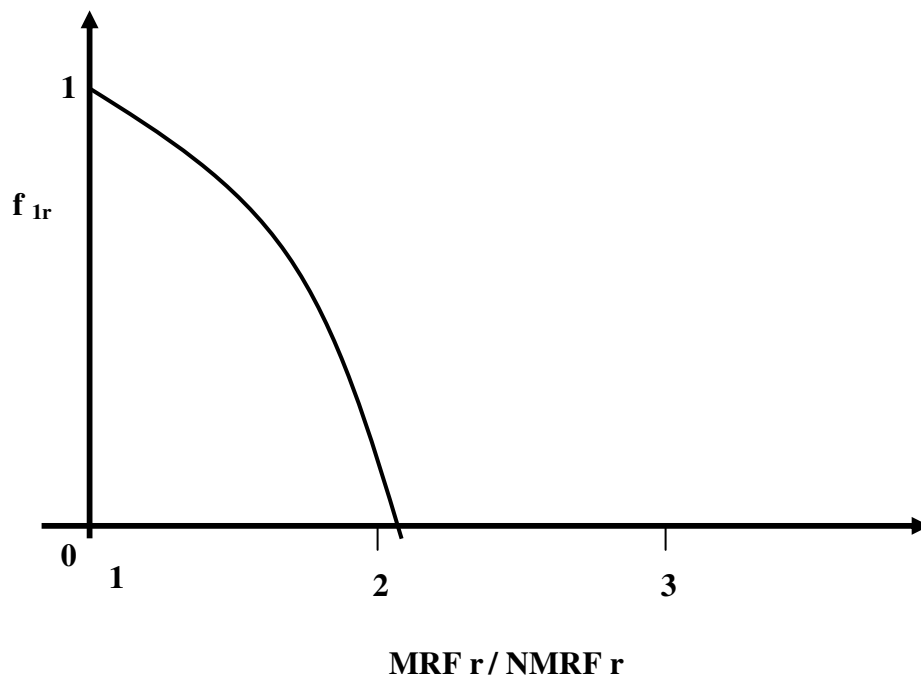
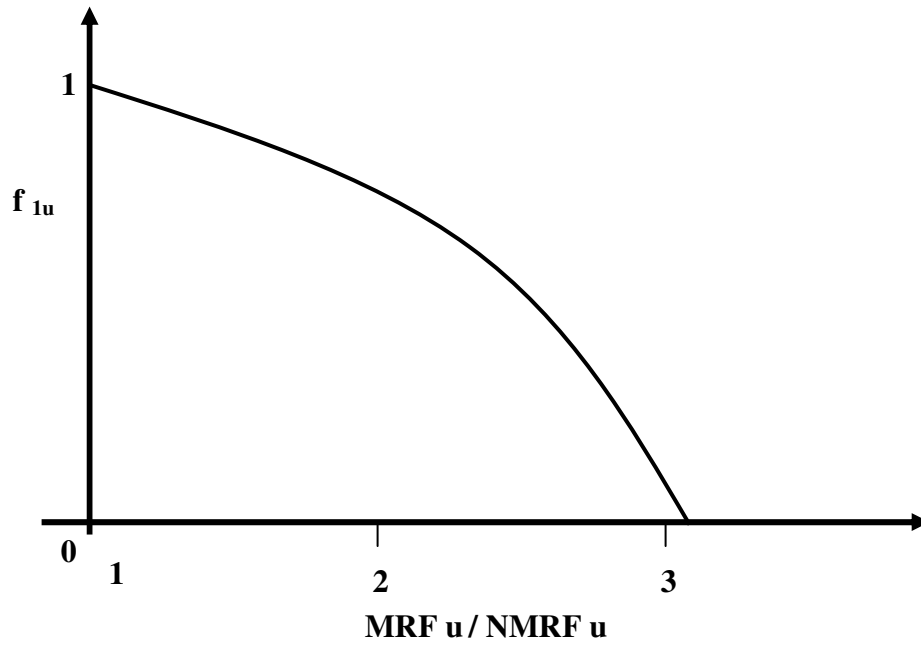
Walsham G. 1979. Models for telecommunications strategy in LDCs. *Telecommunications Policy*, June 1979, 105-115.

Wang L, Gao B, Zheng H, Gao W, Zhao W. 2001. A Study of Methods of Telecommunication Tariff Decision, *The Journal of China Universities of Posts and Telecommunications* **8** (1): 56-62.

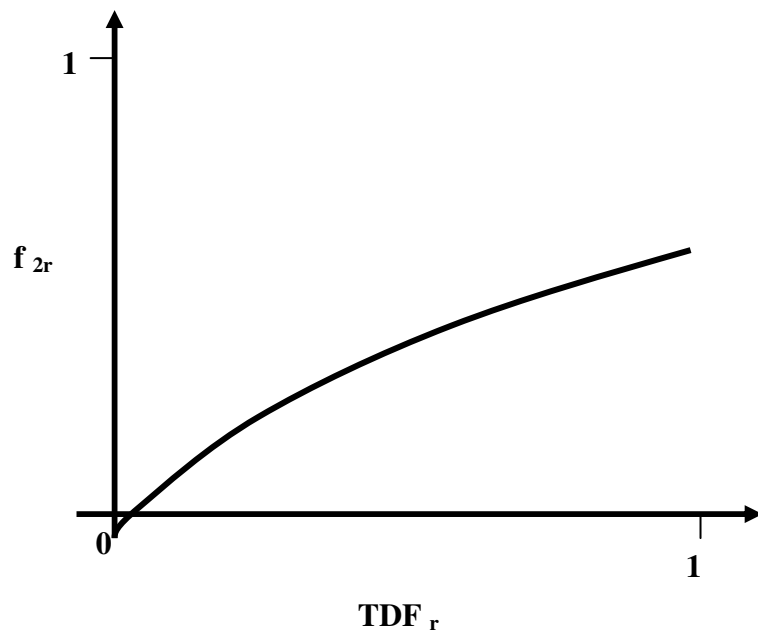
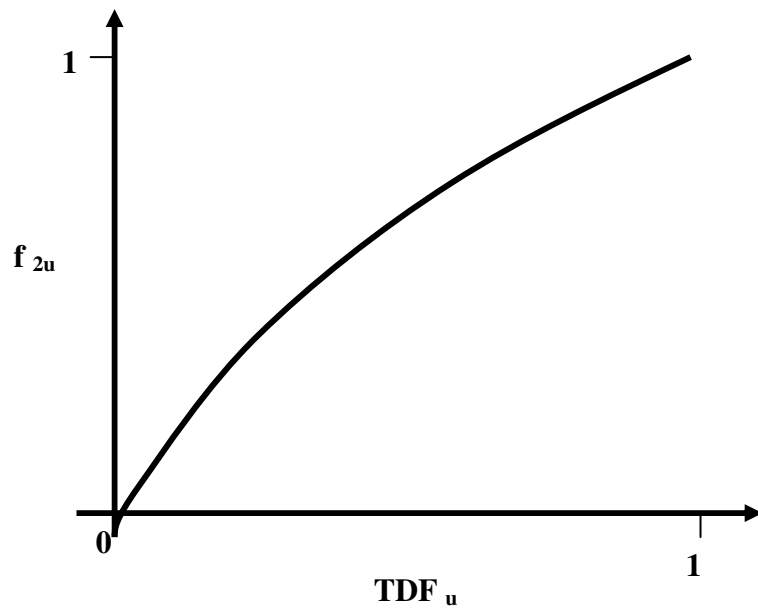
- Warren K. 2002. *Competitive Strategy Dynamics*. John Wiley & Sons Ltd.: West Sussex, England.
- Webb W. 2000. *Introduction to Wireless Local Loop, Second Edition: Broadband and Narrowband Systems*. Artech House, Inc.: Norwood, MA.
- Wellenius B. 1969. Hidden Residential Connections Demand in the Presence of Severe Supply Shortage. *IEEE Transactions on Communications Technology* (June).
- Wellenius B. 2002. *Closing the Gap in Access to Rural Communications. Chile 1995-2002*. World Bank Discussion Paper 430. The World Bank: Washington D.C.
- World Bank. 2002. Using Information and communications technology to reduce poverty in rural India. *PREMnotes* **70**, June 2002
- World Development Indicators. 2002. The World Bank: Washington D.C.
- World Telecommunications Development Report. 2001. International Telecommunications Union: Geneva.
- World Telecommunication Indicators Database (8th Edition). 2004. International Telecommunications Union: Geneva.
- Xavier P. 1996. Monitoring telecommunications deregulation through international benchmarking. *Telecommunications Policy* **20** (8): 585-606
- Yearbook of Statistics. Telecommunication Services 1991-2000. 2001. International Telecommunications Union: Geneva.
- Zhang W, Liang X. 1998. A system dynamics model for pricing telecommunication services. 1998 *International Conference on Communications Technology*, Beijing, China.

**APENDIX A: BEHAVIORAL RELATIONSHIPS**

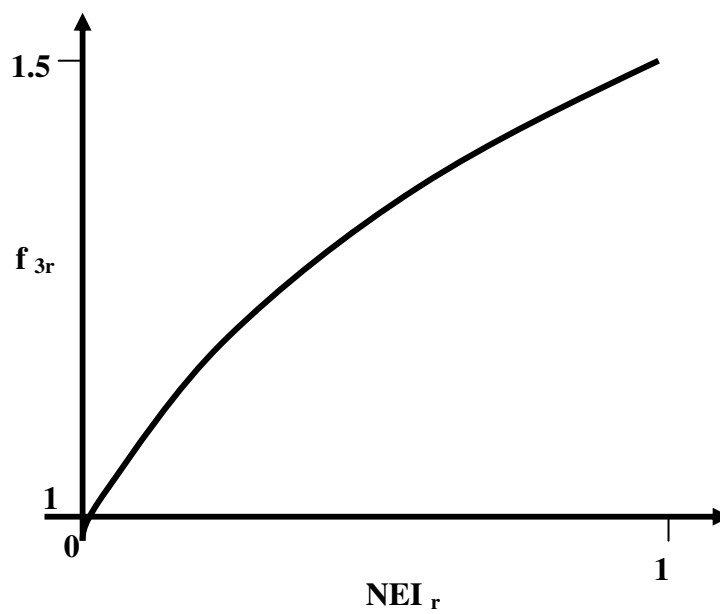
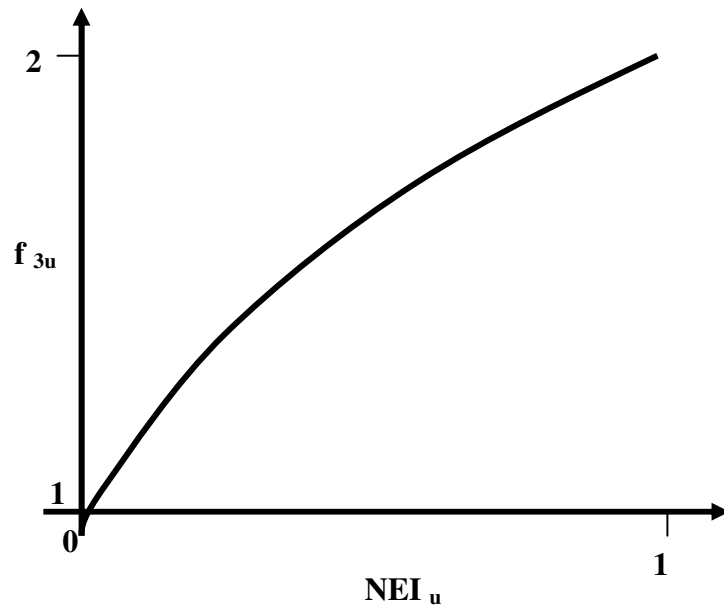
$$\text{MRFF}_i = f_{1i} (\text{MRF}_i / \text{NMRF}_i)$$



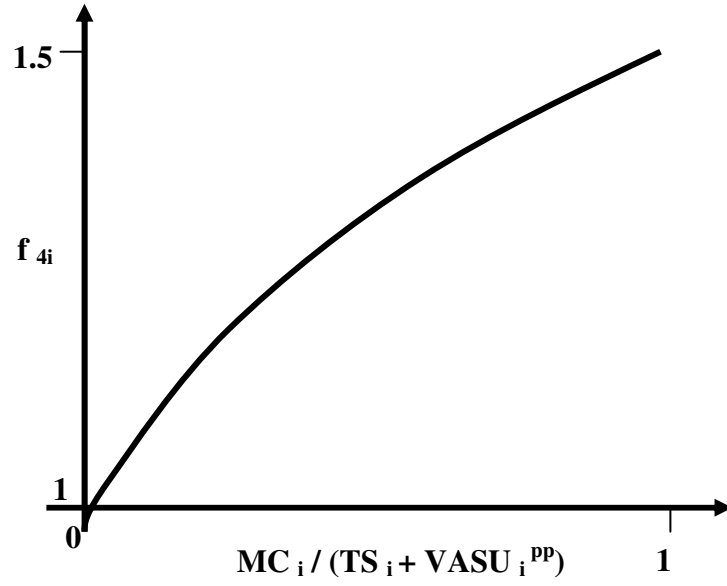
$$NEI_i = f_{2i}(TDF_i)$$



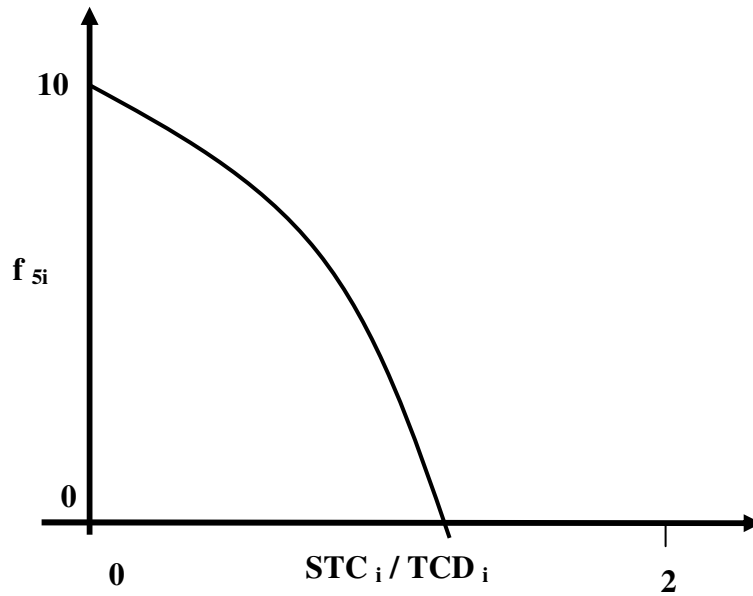
$$\text{TEISN}_i = f_{3i}(\text{NEI}_i)$$



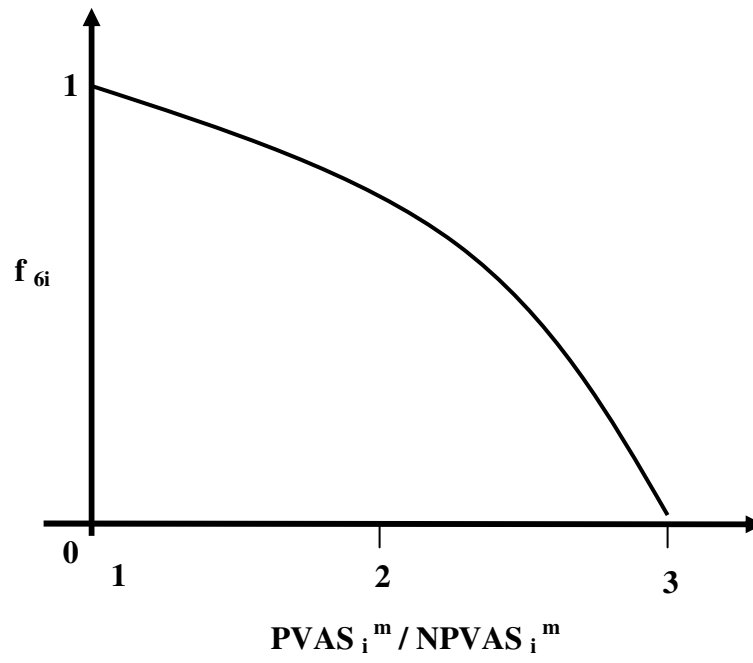
$$\text{TEIM}_i = f_{4i} [\text{MC}_i / (\text{TS}_i + \text{VASU}_i^{\text{PP}})]$$



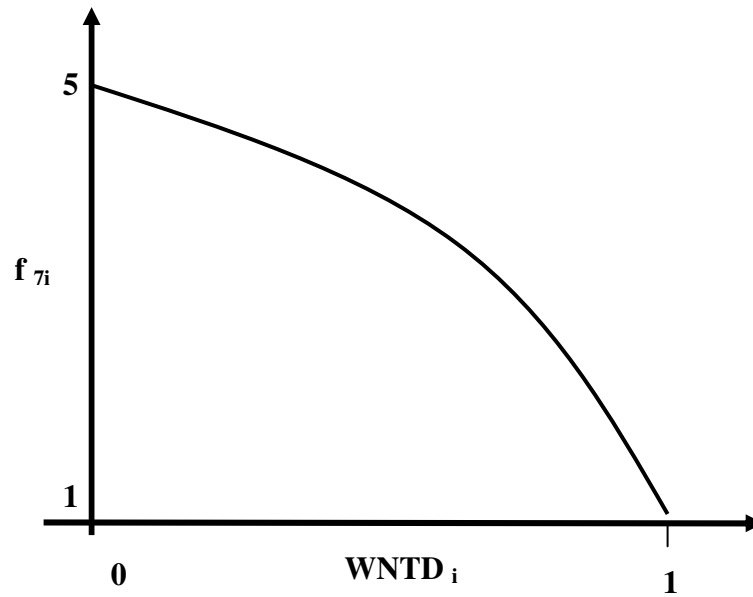
$$f_{5i} (\text{STC}_i / \text{TCD}_i)$$



$$PFVAS_i^m = f_{6i}(PVAS_i^m / NPVAS_i^m)$$



$$NLTD_i = f_{7i}(WNTD_i)$$

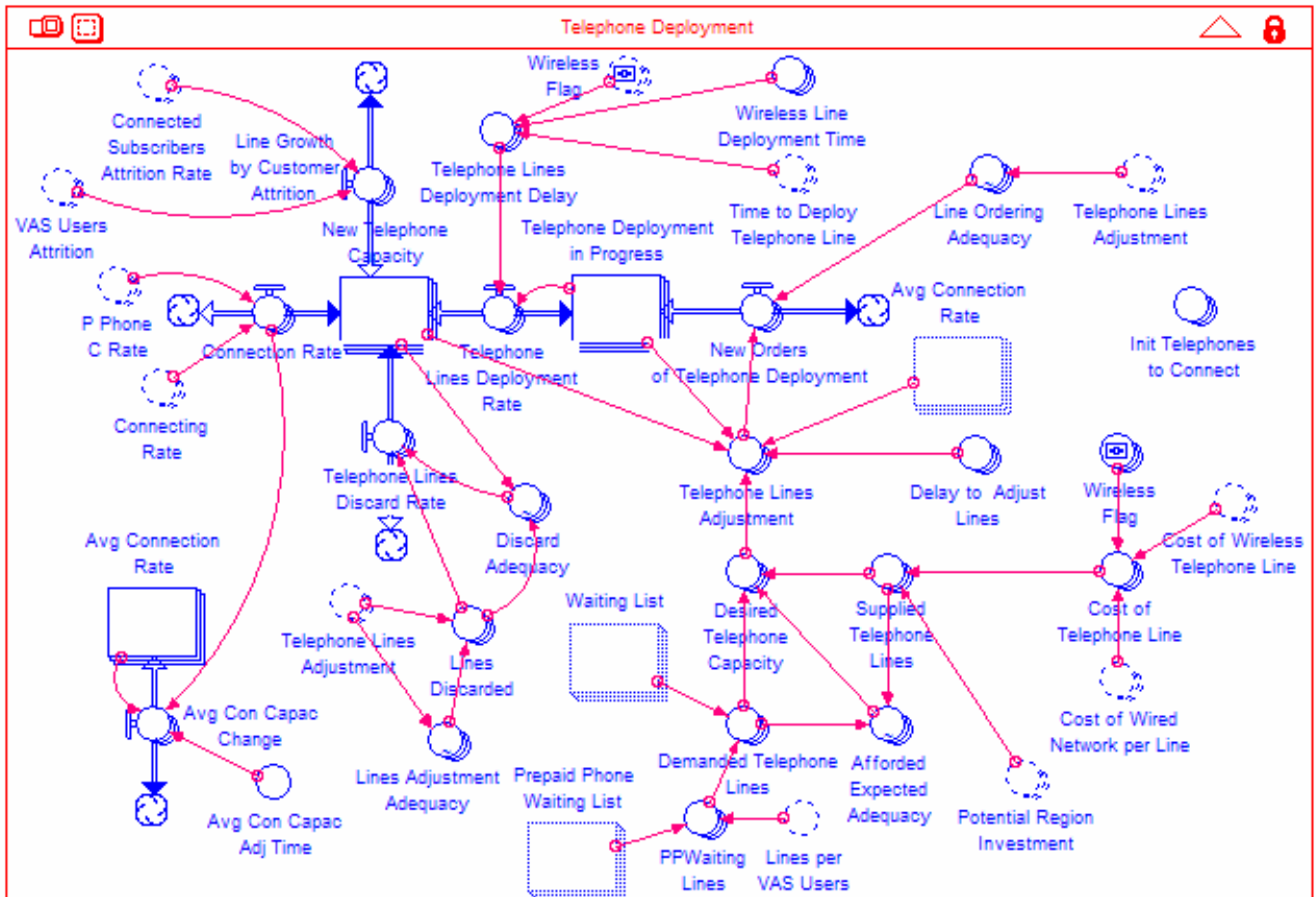




## APPENDIX B: MODEL LISTINGS

### EQUATIONS OF THE REGIONAL TELECOM SYSTEM

#### TELEPHONE DEPLOYMENT EQUATIONS:



$$\text{Avg\_Connection\_Rate[Urban]}(t) = \text{Avg\_Connection\_Rate[Urban]}(t - dt) + (\text{Avg\_Con\_Capac\_Change[Urban]}) * dt$$

$$\text{INIT Avg\_Connection\_Rate[Urban]} = 0$$

$$\text{Avg\_Connection\_Rate[Rural]}(t) = \text{Avg\_Connection\_Rate[Rural]}(t - dt) + (\text{Avg\_Con\_Capac\_Change[Rural]}) * dt$$

$$\text{INIT Avg\_Connection\_Rate[Rural]} = 0$$

INFLOWS:

$$\text{Avg\_Con\_Capac\_Change[Region]} = (\text{Connection\_Rate[Region]} - \text{Avg\_Connection\_Rate[Region]}) / \text{Avg\_Con\_Capac\_Adj\_Time}$$

$$\text{New\_Telephone\_Capacity[Region]}(t) = \text{New\_Telephone\_Capacity[Region]}(t - dt) + (\text{Telephone\_Lines\_Deployment\_Rate[Region]} + \text{Line\_Growth\_by\_Customer\_Attrition[Region]} - \text{Telephone\_Lines\_Discard\_Rate[Region]} - \text{Connection\_Rate[Region]}) * dt$$

$$\text{INIT New\_Telephone\_Capacity[Region]} = \text{Init\_Telephones\_to\_Connect[Region]}$$

INFLOWS:

$$\text{Telephone\_Lines\_Deployment\_Rate[Region]} = \text{Telephone\_Deployment\_in\_Progress[Region]} / \text{Telephone\_Lines\_Deployment\_Delay[Region]}$$

$$\text{Line\_Growth\_by\_Customer\_Attrition[Region]} = \text{Connected\_Subscribers\_Attrition\_Rate[Region]} + \text{VAS\_Users\_Attrition[Prepaid\_Phone, Region]}$$

OUTFLOWS:

$$\text{Telephone\_Lines\_Discard\_Rate[Region]} = \text{Discard\_Adequacy[Region]} * \text{Lines\_Discarded[Region]}$$

$$\text{Connection\_Rate[Region]} = \text{Connecting\_Rate[Region]} + \text{P\_Phone\_C\_Rate[Prepaid\_Phone, Region]}$$

$$\text{Telephone\_Deployment\_in\_Progress[Urban]}(t) = \text{Telephone\_Deployment\_in\_Progress[Urban]}(t - dt) + (\text{New\_Orders\_of\_Telephone\_Deployment[Urban]} - \text{Telephone\_Lines\_Deployment\_Rate[Urban]}) * dt$$

$$\text{INIT Telephone\_Deployment\_in\_Progress[Urban]} = 0$$

$$\text{Telephone\_Deployment\_in\_Progress[Rural]}(t) = \text{Telephone\_Deployment\_in\_Progress[Rural]}(t - dt) + (\text{New\_Orders\_of\_Telephone\_Deployment[Rural]} - \text{Telephone\_Lines\_Deployment\_Rate[Rural]}) * dt$$

$$\text{INIT Telephone\_Deployment\_in\_Progress[Rural]} = 0$$

INFLOWS:

$$\text{New\_Orders\_of\_Telephone\_Deployment[Region]} = \text{Line\_Ordering\_Adequacy[Region]} * \text{Telephone\_Lines\_Adjustment[Region]}$$

OUTFLOWS:

$$\text{Telephone\_Lines\_Deployment\_Rate[Region]} = \text{Telephone\_Deployment\_in\_Progress[Region]} / \text{Telephone\_Lines\_Deployment\_Delay[Region]}$$

$$\text{Avg\_Con\_Capac\_Adj\_Time} = 3$$

$$\text{Cost\_of\_Telephone\_Line[Region]} = \text{IF}(\text{Wireless\_Flag[Region]}=1)\text{THEN}(\text{Cost\_of\_Wireless\_Telephone\_Line[Region]})\text{ELSE}(\text{Cost\_of\_Wired\_Network\_per\_Line[Region]})$$

$$\text{Delay\_to\_Adjust\_Lines[Urban]} = 3$$

Delay\_to\_\_Adjust\_Lines[Rural] = 3  
 Demanded\_Telephone\_\_Lines[Region] =  
 Waiting\_List[Region]+PPWaiting\_Lines[Region]  
 Desired\_Telephone\_Capacity[Region] = Supplied\_\_Telephone\_Lines[Region]-  
 Afforded\_\_Expected\_Adequacy[Region]\*(Supplied\_\_Telephone\_Lines[Region]-  
 Demanded\_Telephone\_\_Lines[Region])  
 Init\_Telephones\_to\_Connect[Urban] = 10000  
 Init\_Telephones\_to\_Connect[Rural] = 100  
 Lines\_\_Discarded[Region] =  
 Telephone\_Lines\_Adjustment[Region]\*Lines\_Adjustment\_Adequacy[Region]  
 PPWaiting\_Lines[Region] =  
 Prepaid\_Phone\_Waiting\_List[Region]\*Lines\_per\_VAS\_Users  
 Supplied\_\_Telephone\_Lines[Region] =  
 Potential\_Region\_Investment[Region]/Cost\_of\_\_Telephone\_Line[Region]  
 Telephone\_Lines\_Adjustment[Region] =  
 Avg\_Connection\_Rate[Region]+(Desired\_Telephone\_Capacity[Region]-  
 New\_Telephone\_Capacity[Region]-  
 Telephone\_Deployment\_\_in\_Progress[Region])/Delay\_to\_\_Adjust\_Lines[Region]  
 Telephone\_Lines\_\_Deployment\_Delay[Region] =  
 IF(Wireless\_Flag[Region]=1)THEN(Wireless\_Line\_Deployment\_Time[Region])ELSE  
 (Time\_to\_Deploy\_Telephone\_Line[Region])  
 Wireless\_Flag[Region] = 0  
 Wireless\_Line\_Deployment\_Time[Urban] = 6  
 Wireless\_Line\_Deployment\_Time[Rural] = 8  
 Afforded\_\_Expected\_Adequacy[Region] =  
 GRAPH(Supplied\_\_Telephone\_Lines[Region]/(Demanded\_Telephone\_\_Lines[Region]  
 +0.0001))  
 (1.00, 0.00), (1.01, 0.38), (1.02, 0.68), (1.03, 0.825), (1.04, 0.91), (1.05, 0.97), (1.06,  
 0.995), (1.07, 1.00), (1.08, 1.00), (1.09, 1.00), (1.10, 1.00)  
 Discard\_\_Adequacy[Region] =  
 GRAPH(New\_Telephone\_Capacity[Region]/(Lines\_\_Discarded[Region]+1))  
 (0.00, 0.00), (1.00, 0.335), (2.00, 0.535), (3.00, 0.705), (4.00, 0.82), (5.00, 0.895), (6.00,  
 0.94), (7.00, 0.975), (8.00, 0.99), (9.00, 1.00), (10.0, 1.00)  
 Lines\_Adjustment\_Adequacy[Region] =  
 GRAPH(Telephone\_Lines\_Adjustment[Region])  
 (-1.00, -1.00), (-0.9, -0.7), (-0.8, -0.45), (-0.7, -0.295), (-0.6, -0.19), (-0.5, -0.115), (-0.4,  
 -0.065), (-0.3, -0.025), (-0.2, -0.01), (-0.1, -0.005), (-1.39e-016, 0.00)  
 Line\_Ordering\_Adequacy[Region] = GRAPH(Telephone\_Lines\_Adjustment[Region])  
 (0.00, 0.00), (0.1, 0.275), (0.2, 0.5), (0.3, 0.66), (0.4, 0.78), (0.5, 0.865), (0.6, 0.92),  
 (0.7, 0.955), (0.8, 0.975), (0.9, 0.99), (1, 1.00)



$\text{Telecom\_Cash\_Balance}(t) = \text{Telecom\_Cash\_Balance}(t - dt) + (\text{Telecom\_Income} - \text{Telecom\_Expenses}) * dt$   
 INIT Telecom\_Cash\_Balance = Initial\_Cash\_Balance

INFLOWS:

Telecom\_Income =  
 Total\_Telephone\_Serv\_Income+Activation\_Income[Urban]+Activation\_Income[Rural]  
 +Net\_Settlement+Total\_VAS\_Income

OUTFLOWS:

Telecom\_Expenses =  
 Actual\_T\_Line\_Investment\_per\_Month[Urban]+Actual\_T\_Line\_Investment\_per\_Month[Rural]+Operating\_costs[Urban]+Operating\_costs[Rural]+Total\_VAS\_Investment+License\_Expense

Activation\_Fee[Urban] = 76

Activation\_Fee[Rural] = 22

Activation\_Income[Region] =

$\text{Activation\_Fee}[\text{Region}] * (\text{Connecting\_Rate}[\text{Region}] + \text{P\_Phone\_C\_Rate}[\text{Prepaid\_Phone, Region}] * \text{Lines\_per\_VAS\_Users})$

Actual\_T\_Line\_Investment\_per\_Month[Region] =

$\text{New\_Orders\_of\_Telephone\_Deployment}[\text{Region}] * \text{Cost\_of\_Telephone\_Line}[\text{Region}]$

Capital\_Costs[Region] =

$\text{Telephone\_Capital\_Costs}[\text{Region}] + \text{VAS\_Capital\_Costs}[\text{Region}]$

CCard\_Infra\_per\_User = 1

CCard\_Infra[Region] =

$(\text{VAS\_Users}[\text{Virtual\_Telephony, Region}] + \text{VAS\_Users}[\text{Payphone, Region}] + \text{VAS\_Users}[\text{Prepaid\_Phone, Region}]) * \text{CCard\_Infra\_per\_User}$

Fraction\_of\_Cap\_Costs\_as\_part\_of\_Operating\_Costs = 0.3

Free\_Service\_Minutes[URLOCAL] = 100

Free\_Service\_Minutes[RULOCAL] = 100

Free\_Service\_Minutes[INTERURB] = 0.0001

Free\_Service\_Minutes[INTERRUR] = 0.0001

Free\_Service\_Minutes[LDURB] = 0.0001

Free\_Service\_Minutes[LDRUR] = 0.0001

Imbalance\_Internat\_Traffic\_per\_Subscriber[Urban] =

$\text{Incoming\_International\_Traffic}[\text{Urban}] - \text{Service\_Time\_per\_Line}[\text{INTERURB}]$

Imbalance\_Internat\_Traffic\_per\_Subscriber[Rural] =

$\text{IF}(\text{Incoming\_International\_Traffic}[\text{Rural}] - \text{Service\_Time\_per\_Line}[\text{INTERRUR}] > 0)$   
 $\text{THEN}(\text{Incoming\_International\_Traffic}[\text{Rural}] - \text{Service\_Time\_per\_Line}[\text{INTERRUR}])$

ELSE (0)

Initial\_Cash\_Balance = 0

Inv\_Fract = 1

License\_Expense = License\_\_Cost/License\_\_Duration/Months\_per\_Year  
 License\_\_Cost = 0  
 License\_\_Duration = 15  
 Maibox\_Infra[Region] =  
 VAS\_Users[Virtual\_Telephony,Region]\*Mailbox\_Infra\_per\_User  
 Mailbox\_Infra\_per\_User = 1  
 Monthly\_Fraction\_Operating\_Costs = 1/12  
 Net\_Settlement =  
 (Total\_Phone\_Lines[Urban]\*Imbalance\_Internat\_Traffic\_per\_Subscriber[Urban]\*Settle  
 ment\_Rate)+(Total\_Phone\_Lines[Rural]\*Imbalance\_Internat\_Traffic\_per\_Subscriber[R  
 ural]\*Settlement\_Rate)  
 New\_CCard\_Infrastructure[Region] =  
 (VAS\_Adoption[Virtual\_Telephony,Region]+VAS\_Adoption[Payphone,Region]+P\_Ph  
 one\_C\_Rate[Prepaid\_Phone,Region])\*CCard\_Infra\_per\_User  
 New\_Mailbox\_Infrastructure[Region] =  
 VAS\_Adoption[Virtual\_Telephony,Region]\*Mailbox\_Infra\_per\_User  
 New\_Payphone\_Infrastructure[Region] =  
 New\_Orders\_\_of\_Payphone\_Deployment[Payphones, Region]  
 Operating\_costs[Region] =  
 Capital\_\_Costs[Region]\*Fraction\_of\_Cap\_Costs\_as\_part\_of\_Operating\_Costs\*Monthl  
 y\_Fraction\_Operating\_Costs  
 Payphone\_Infrastructure[Region] = Payphone\_\_Installed[Payphones,  
 Region]+Payphone\_Deployment\_\_in\_Progress[Payphones, Region]  
 Payphone\_Total\_Investment =  
 Potential\_Total\_\_Investment\*VAS\_\_Investment\_Fraction  
 Potential\_Region\_Investment[Urban] =  
 Potential\_Total\_\_Investment\*Urban\_Inv\_Fr+0\*Rural\_Investment\_Fraction  
 Potential\_Region\_Investment[Rural] =  
 Potential\_Total\_\_Investment\*Rural\_Investment\_Fraction+0\*Urban\_Inv\_Fr  
 Potential\_Total\_\_Investment =  
 Telecom\_Cash\_\_Balance\*Inv\_Fract\*Investment\_\_Adequacy  
 Rural\_Investment\_Fraction = Universal\_Service\_\_Obligation  
 Service\_Customers[URLOCAL] = Connected\_\_Subscribers[Urban]  
 Service\_Customers[RULOCAL] = Connected\_\_Subscribers[Rural]  
 Service\_Customers[INTERURB] = Connected\_\_Subscribers[Urban]  
 Service\_Customers[INTERRUR] = Connected\_\_Subscribers[Rural]  
 Service\_Customers[LDURB] = Connected\_\_Subscribers[Urban]  
 Service\_Customers[LDRUR] = Connected\_\_Subscribers[Rural]  
 Settlement\_Rate = Price\_of\_Traffic\_per\_Service[INTERURB]/2  
 Telephone\_Service\_\_Income[URLOCAL] =  
 ((Price\_of\_Traffic\_per\_Service[URLOCAL]\*(Service\_Time\_per\_Line[URLOCAL]-  
 Free\_Service\_\_Minutes[URLOCAL])\*Local\_Time\_Adequacy[URLOCAL])+M\_Renta  
 l\_Fee[Urban])\*Service\_Customers[URLOCAL]

$$\text{Telephone\_Service\_Income[RULOCAL]} = ((\text{Price\_of\_Traffic\_per\_Service[RULOCAL]} * (\text{Service\_Time\_per\_Line[RULOCAL]} - \text{Free\_Service\_Minutes[RULOCAL]})) * \text{Local\_Time\_Adequacy[RULOCAL]}) + \text{M\_Rental\_Fee[Rural]} * \text{Service\_Customers[RULOCAL]}$$

$$\text{Telephone\_Service\_Income[INTERURB]} = (\text{Price\_of\_Traffic\_per\_Service[INTERURB]} * \text{Service\_Customers[INTERURB]} * \text{Service\_Time\_per\_Line[INTERURB]}) + 0 * \text{M\_Rental\_Fee[Urban]} * \text{Free\_Service\_Minutes[INTERURB]} * \text{Local\_Time\_Adequacy[INTERURB]}$$

$$\text{Telephone\_Service\_Income[INTERRUR]} = (\text{Price\_of\_Traffic\_per\_Service[INTERRUR]} * \text{Service\_Customers[INTERRUR]} * \text{Service\_Time\_per\_Line[INTERRUR]}) + 0 * \text{M\_Rental\_Fee[Urban]} * \text{Free\_Service\_Minutes[INTERRUR]} * \text{Local\_Time\_Adequacy[INTERRUR]}$$

$$\text{Telephone\_Service\_Income[LDURB]} = \text{Service\_Time\_per\_Line[LDURB]} * \text{Price\_of\_Traffic\_per\_Service[LDURB]} * \text{Service\_Customers[LDURB]} + 0 * \text{M\_Rental\_Fee[Urban]} * \text{Free\_Service\_Minutes[LDURB]} * \text{Local\_Time\_Adequacy[LDURB]}$$

$$\text{Telephone\_Service\_Income[LDRUR]} = \text{Service\_Time\_per\_Line[LDRUR]} * \text{Price\_of\_Traffic\_per\_Service[LDRUR]} * \text{Service\_Customers[LDRUR]} + 0 * \text{M\_Rental\_Fee[Rural]} * \text{Free\_Service\_Minutes[LDRUR]} * \text{Local\_Time\_Adequacy[LDRUR]}$$

$$\text{Telephone\_Capital\_Costs[Region]} = \text{Cost\_of\_Telephone\_Line[Region]} * \text{Total\_Telephone\_Lines[Region]}$$

$$\text{Total\_Telephone\_Lines[Region]} = \text{Connected\_Subscribers[Region]} + \text{New\_Telephone\_Capacity[Region]} + \text{Telephone\_Deployment\_in\_Progress[Region]} + \text{Prepaid\_Tel\_Lines[Region]}$$

$$\text{Total\_Telephone\_Serv\_Income} = \text{Telephone\_Service\_Income[URLOCAL]} + \text{Telephone\_Service\_Income[RULOCAL]} + \text{Telephone\_Service\_Income[INTERURB]} + \text{Telephone\_Service\_Income[INTERRUR]} + \text{Telephone\_Service\_Income[LDURB]} + \text{Telephone\_Service\_Income[LDRUR]}$$

$$\text{Total\_VAS\_Income} = \text{VAS\_Income[Virtual\_Telephony,Urban]} + \text{VAS\_Income[Virtual\_Telephony,Rural]} + \text{VAS\_Income[Payphone,Urban]} + \text{VAS\_Income[Payphone,Rural]} + \text{VAS\_Income[Prepaid\_Phone,Urban]} + \text{VAS\_Income[Prepaid\_Phone,Rural]}$$

$$\text{Total\_VAS\_Investment} = \text{VAS\_Investment\_per\_Month[Urban]} + \text{VAS\_Investment\_per\_Month[Rural]}$$

$$\text{Urban\_Inv\_Fr} = 1 - \text{Rural\_Investment\_Fraction} - \text{VAS\_Investment\_Fraction}$$

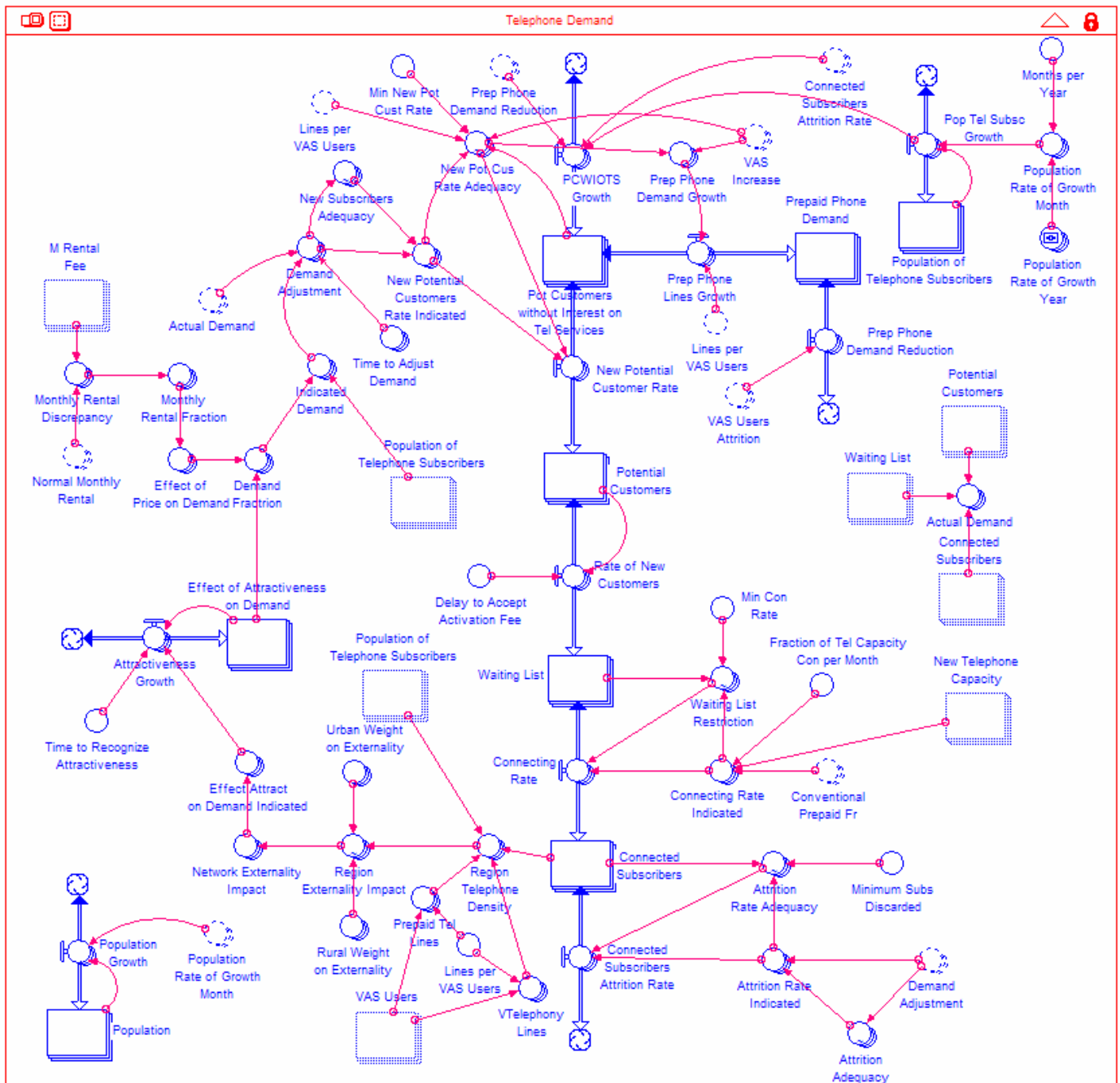
$$\text{VAS\_Capital\_Costs[Region]} = \text{Mailbox\_Infra[Region]} * \text{Cost\_of\_each\_Mail\_Box} + \text{Payphone\_Infrastructure[Region]} * \text{Cost\_of\_each\_Payphone[Region]} + \text{CCard\_Infra[Region]} * \text{Cost\_Calling\_Card\_Number}$$

$$\text{VAS\_Investment\_per\_Month[Region]} = \text{New\_Mailbox\_Infrastructure[Region]} * \text{Cost\_of\_each\_Mail\_Box} + \text{New\_CCard\_Infrastructure[Region]} * \text{Cost\_Calling\_Card\_Number} + \text{New\_Payphone\_Infrastructure[Region]} * \text{Cost\_of\_each\_Payphone[Region]}$$

VAS\_\_Income[VAS,Region] = VAS\_Users[VAS,Region]\*VAS\_Price[VAS,Region]  
VAS\_\_Investment\_Fraction = VAS\_Investment\_Policy  
Investment\_\_Adequacy = GRAPH(Telecom\_Cash\_\_Balance)  
(0.00, 0.00), (100, 0.00), (200, 0.01), (300, 0.04), (400, 0.07), (500, 0.11), (600, 0.165),  
(700, 0.25), (800, 0.385), (900, 0.595), (1000, 1.00)  
Local\_Time\_Adequacy[Service] =  
GRAPH(Service\_Time\_per\_Line[Service]/Free\_Service\_\_Minutes[Service])  
(0.99, 0.00), (0.991, 0.475), (0.992, 0.76), (0.993, 0.94), (0.994, 1.00), (0.995, 1.00),  
(0.996, 1.00), (0.997, 1.00), (0.998, 1.00), (0.999, 1.00), (1.00, 1.00)



## TELEPHONE DEMAND EQUATIONS:



$$\text{Connected\_Subscribers}[\text{Region}](t) = \text{Connected\_Subscribers}[\text{Region}](t - dt) + (\text{Connecting\_Rate}[\text{Region}] - \text{Connected\_Subscribers\_Attrition\_Rate}[\text{Region}]) * dt$$

INIT Connected\_\_Subscribers[Region] = Con\_Subscribers\_Init[Region]

INFLOWS:

Connecting\_Rate[Region] =

Connecting\_Rate\_Indicated[Region]\*Waiting\_List\_Restriction[Region]

OUTFLOWS:

Connected\_\_Subscribers\_\_Attrition\_Rate[Region] =

Attrition\_Rate\_Indicated[Region]\*Attrition\_Rate\_Adequacy[Region]

Effect\_of\_Attractiveness\_on\_Demand[Region](t) =

Effect\_of\_Attractiveness\_on\_Demand[Region](t - dt) +

(Attractiveness\_\_Growth[Region]) \* dt

INIT Effect\_of\_Attractiveness\_on\_Demand[Region] =

Effect\_Attract\_on\_Demand\_Indicated[Region]

INFLOWS:

Attractiveness\_\_Growth[Region] = (Effect\_Attract\_on\_Demand\_Indicated[Region]-

Effect\_of\_Attractiveness\_on\_Demand[Region])/Time\_to\_Recognize\_Attractiveness

Population[Region](t) = Population[Region](t - dt) + (Population\_Growth[Region]) \* dt

INIT Population[Region] = Init\_Region\_Population[Region]

INFLOWS:

Population\_Growth[Region] =

Population[Region]\*Population\_Rate\_of\_Growth\_Month[Region]

Population\_of\_Telephone\_Subscribers[Region](t) =

Population\_of\_Telephone\_Subscribers[Region](t - dt) +

(Pop\_Tel\_Subsc\_Growth[Region]) \* dt

INIT Population\_of\_Telephone\_Subscribers[Region] = Init\_Pop\_Tel\_Subsc[Region]

INFLOWS:

Pop\_Tel\_Subsc\_Growth[Region] =

Population\_of\_Telephone\_Subscribers[Region]\*Population\_Rate\_of\_Growth\_Month[Region]

Potential\_\_Customers[Urban](t) = Potential\_\_Customers[Urban](t - dt) +

(New\_Potential\_\_Customer\_Rate[Urban] - Rate\_of\_New\_Customers[Urban]) \* dt

INIT Potential\_\_Customers[Urban] = 0

Potential\_\_Customers[Rural](t) = Potential\_\_Customers[Rural](t - dt) +

(New\_Potential\_\_Customer\_Rate[Rural] - Rate\_of\_New\_Customers[Rural]) \* dt

INIT Potential\_\_Customers[Rural] = 0

INFLOWS:

New\_Potential\_\_Customer\_Rate[Region] =

New\_Potential\_Customers\_\_Rate\_Indicated[Region]\*New\_Pot\_Cus\_Rate\_Adequacy[Region]

OUTFLOWS:

Rate\_of\_New\_Customers[Region] =

Potential\_\_Customers[Region]/Delay\_to\_Accept\_Activation\_Fee

$Pot\_Customers\_without\_Interest\_on\_Tel\_Services[Region](t) =$   
 $Pot\_Customers\_without\_Interest\_on\_Tel\_Services[Region](t - dt) +$   
 $(PCWIOTS\_Growth[Region] - New\_Potential\_Customer\_Rate[Region] -$   
 $Prep\_Phone\_Lines\_Growth[Region]) * dt$   
 $INIT Pot\_Customers\_without\_Interest\_on\_Tel\_Services[Region] =$   
 $Init\_Pot\_Cust\_WIOTS[Region]$   
**INFLOWS:**  
 $PCWIOTS\_Growth[Region] =$   
 $Pop\_Tel\_Subsc\_Growth[Region] + Connected\_Subscribers\_Attrition\_Rate[Region] + P$   
 $rep\_Phone\_Demand\_Reduction[Region]$   
**OUTFLOWS:**  
 $New\_Potential\_Customer\_Rate[Region] =$   
 $New\_Potential\_Customers\_Rate\_Indicated[Region] * New\_Pot\_Cus\_Rate\_Adequacy[$   
 $Region]$   
 $Prep\_Phone\_Lines\_Growth[Region] =$   
 $Prep\_Phone\_Demand\_Growth[Region] * Lines\_per\_VAS\_Users$   
 $Prepaid\_Phone\_Demand[Region](t) = Prepaid\_Phone\_Demand[Region](t - dt) +$   
 $(Prep\_Phone\_Lines\_Growth[Region] - Prep\_Phone\_Demand\_Reduction[Region]) * dt$   
 $INIT Prepaid\_Phone\_Demand[Region] = 0$   
**INFLOWS:**  
 $Prep\_Phone\_Lines\_Growth[Region] =$   
 $Prep\_Phone\_Demand\_Growth[Region] * Lines\_per\_VAS\_Users$   
**OUTFLOWS:**  
 $Prep\_Phone\_Demand\_Reduction[Region] = VAS\_Users\_Attrition[Prepaid\_Phone,$   
 $Region]$   
 $Waiting\_List[Region](t) = Waiting\_List[Region](t - dt) +$   
 $(Rate\_of\_New\_Customers[Region] - Connecting\_Rate[Region]) * dt$   
 $INIT Waiting\_List[Region] = Waiting\_List\_Init[Region]$   
**INFLOWS:**  
 $Rate\_of\_New\_Customers[Region] =$   
 $Potential\_Customers[Region] / Delay\_to\_Accept\_Activation\_Fee$   
**OUTFLOWS:**  
 $Connecting\_Rate[Region] =$   
 $Connecting\_Rate\_Indicated[Region] * Waiting\_List\_Restriction[Region]$   
 $Actual\_Demand[Region] =$   
 $Connected\_Subscribers[Region] + Potential\_Customers[Region] + Waiting\_List[Regio$   
 $n]$   
 $Attrition\_Rate\_Indicated[Region] =$   
 $Demand\_Adjustment[Region] * Attrition\_Adequacy[Region]$   
 $Connecting\_Rate\_Indicated[Region] =$   
 $New\_Telephone\_Capacity[Region] * Fraction\_of\_Tel\_Capacity\_Con\_per\_Month * Conv$   
 $entional\_Prepaid\_Fr[Region]$   
 $Con\_Subscribers\_Init[Urban] = Total\_Con\_Subs\_Initial * (1 - Percent\_Rural\_Lines)$

$Con\_Subscribers\_Init[Rural] = Total\_Con\_Subs\_Initial * Percent\_Rural\_Lines$   
 $Delay\_to\_Accept\_Activation\_Fee = 3$   
 $Demand\_Adjustment[Region] = (Indicated\_Demand[Region] - Actual\_Demand[Region]) / Time\_to\_Adjust\_Demand[Region]$   
 $Demand\_Fractrion[Region] =$   
 $Effect\_of\_Attractiveness\_on\_Demand[Region] * Effect\_of\_Price\_on\_Demand[Region]$   
 $Effect\_Attract\_on\_Demand\_Indicated[Region] = Network\_Externality\_Impact[Region]$   
 $Effect\_of\_Price\_on\_Demand[Region] = Monthly\_Rental\_Fraction[Region]$   
 $Fraction\_of\_Tel\_Capacity\_Con\_per\_Month = 0.25$   
 $Fr\_of\_Exp\_Telecom[Urban] = 0.015$   
 $Fr\_of\_Exp\_Telecom[Rural] = 0.015$   
 $Income\_per\_Capita[Urban] = 1708$   
 $Income\_per\_Capita[Rural] = 310$   
 $Indicated\_Demand[Region] =$   
 $Population\_of\_Telephone\_Subscribers[Region] * Demand\_Fractrion[Region]$   
 $Initial\_Total\_Population = 23000000$   
 $Init\_Pop\_Tel\_Subs[Region] =$   
 $Init\_Region\_Population[Region] * Number\_of\_Lines\_per\_People[Region]$   
 $Init\_Pot\_Cust\_WIOTS[Region] = Init\_Pop\_Tel\_Subs[Region] -$   
 $Waiting\_List\_Init[Region] - Con\_Subscribers\_Init[Region]$   
 $Init\_Region\_Population[Urban] = Initial\_Total\_Population * (1 - Perc\_Rural\_Pop)$   
 $Init\_Region\_Population[Rural] = Initial\_Total\_Population * Perc\_Rural\_Pop$   
 $ITU\_Waitiing\_List = 86022$   
 $Lines\_per\_VAS\_Users = 1$   
 $Minimum\_Subs\_Discarded = 1$   
 $Min\_Con\_Rate = 1$   
 $Min\_New\_Pot\_Cust\_Rate = 1$   
 $Mionthly\_Income\_per\_Capita[Region] =$   
 $Income\_per\_Capita[Region] * Year\_Month\_Relation$   
 $Monthly\_Income\_per\_Subscriber[Region] =$   
 $Mionthly\_Income\_per\_Capita[Region] / Number\_of\_Lines\_per\_People[Region]$   
 $Monthly\_Rental\_Discrepancy[Region] =$   
 $M\_Rental\_Fee[Region] / Normal\_Monthly\_Rental[Region]$   
 $Monthly\_Rental\_Fraction[Region] = Monthly\_Rental\_Discrepancy[Region]$   
 $Months\_per\_Year = 12$   
 $Network\_Externality\_Impact[Region] = Region\_Externality\_Impact[Region]$   
 $New\_Potential\_Customers\_Rate\_Indicated[Region] =$   
 $Demand\_Adjustment[Region] * New\_Subscribers\_Adequacy[Region]$   
 $Number\_of\_Lines\_per\_People[Region] =$   
 $Num\_of\_Lines\_per\_House[Region] / Num\_of\_People\_per\_House[Region]$   
 $Num\_of\_Lines\_per\_House[Urban] = 1$   
 $Num\_of\_Lines\_per\_House[Rural] = 1$   
 $Num\_of\_People\_per\_House[Region] = 4$

Percent\_Rural\_Lines = 0.1  
 Perc\_Rural\_Pop = 0.4  
 Population\_Rate\_of\_Growth\_Month[Region] =  
 $((1 + \text{Population\_Rate\_of\_Growth\_Year}[\text{Region}])^{(1/\text{Months\_per\_Year})}) - 1$   
 Population\_Rate\_of\_Growth\_Year[Urban] = 0.023  
 Population\_Rate\_of\_Growth\_Year[Rural] = 0.002  
 Prepaid\_Tel\_Lines[Region] = VAS\_Users[Prepaid\_Phone,  
 Region]\*Lines\_per\_VAS\_Users  
 Prep\_Phone\_Demand\_Growth[Region] = VAS\_Increase[Prepaid\_Phone,  
 Region]\*New\_Pot\_Cus\_Rate\_Adequacy[Region]  
 Ref\_Tel\_Exp\_per\_Line[Region] =  
 $\text{Fr\_of\_Exp\_Telecom}[\text{Region}] * \text{Monthly\_Income\_per\_Subscriber}[\text{Region}] * \text{Telecom\_Ex}$   
 $\text{penditure\_Incr\_Size\_of\_the\_Network}[\text{Region}]$   
 Regional\_Fraction\_W\_List[Urban] = 0.9  
 Regional\_Fraction\_W\_List[Rural] = 0.1  
 Region\_Externality\_Impact[Region] =  
 $\text{Region\_Telephone\_Density}[\text{Urban}] * \text{Urban\_Weight\_on\_Externality}[\text{Region}] + \text{Region\_T}$   
 $\text{elephone\_Density}[\text{Rural}] * \text{Rural\_Weight\_on\_Externality}[\text{Region}]$   
 Region\_Telephone\_Density[Region] =  
 $(\text{Connected\_Subscribers}[\text{Region}] + \text{VTelephony\_Lines}[\text{Region}] + \text{Prepaid\_Tel\_Lines}[\text{Re}$   
 $\text{gion}]) / \text{Population\_of\_Telephone\_Subscribers}[\text{Region}]$   
 Rural\_Weight\_on\_Externality[Urban] = 0.1  
 Rural\_Weight\_on\_Externality[Rural] = 0.5  
 Subscriber\_Expenditure\_on\_Telecommunications\_[Region] =  
 $\text{Ref\_Tel\_Exp\_per\_Line}[\text{Region}] * \text{Telecom\_Expenditure\_Increase\_from\_Mobility}[\text{Regi}$   
 $\text{on}]$   
 Telecom\_Expenditure\_Incr\_Size\_of\_the\_Network[Region] =  
 Region\_Externality\_Impact[Region]  
 Time\_to\_Adjust\_Demand[Region] = 60  
 Time\_to\_Recognize\_Attractiveness = 6  
 Total\_Con\_Subs\_Initial = 598287  
 Urban\_Weight\_on\_Externality[Urban] = 0.9  
 Urban\_Weight\_on\_Externality[Rural] = 0.5  
 VTelephony\_Lines[Region] = VAS\_Users[Virtual\_Telephony,  
 Region]\*Lines\_per\_VAS\_Users  
 Waiting\_List\_Initial = ITU\_Waiting\_List\*Waiting\_List\_Unreported\_Factor  
 Waiting\_List\_Init\_[Urban] = Waiting\_List\_Initial\*Regional\_Fraction\_W\_List[Urban]  
 Waiting\_List\_Init\_[Rural] = Waiting\_List\_Initial\*Regional\_Fraction\_W\_List[Rural]  
 Waiting\_List\_Unreported\_Factor = 4  
 Year\_Month\_Relation = 1/12  
 Attrition\_Adequacy[Region] = GRAPH(Demand\_Adjustment[Region])  
 (-1.00, -1.00), (-0.9, -0.99), (-0.8, -0.97), (-0.7, -0.915), (-0.6, -0.775), (-0.5, -0.505), (-  
 0.4, -0.255), (-0.3, -0.115), (-0.2, -0.045), (-0.1, -0.01), (-1.39e-016, 0.00)

Attrition\_Rate\_Adequacy[Region] =  
 GRAPH(Connected\_\_Subscribers[Region]/(Attrition\_Rate\_Indicated[Region]+Minimum\_Subs\_Discarded))  
 (0.00, 0.00), (0.5, 0.01), (1.00, 0.055), (1.50, 0.135), (2.00, 0.27), (2.50, 0.505), (3.00, 0.745), (3.50, 0.895), (4.00, 0.985), (4.50, 1.00), (5.00, 1.00)

Monthly\_\_Rental\_Fraction[Region] = Monthly\_Rental\_Discrepancy[Region]  
 New\_Pot\_Cus\_Rate\_Adequacy[Region] =  
 GRAPH(Pot\_Customers\_without\_Interest\_on\_Tel\_Services[Region]/(New\_Potential\_Customers\_\_Rate\_Indicated[Region]+VAS\_Increase[Prepaid\_Phone, Region]\*Lines\_per\_VAS\_Users+Min\_New\_Pot\_Cust\_Rate))  
 (0.00, 0.00), (0.4, 0.025), (0.8, 0.085), (1.20, 0.185), (1.60, 0.33), (2.00, 0.5), (2.40, 0.715), (2.80, 0.84), (3.20, 0.92), (3.60, 0.98), (4.00, 1.00)

New\_Subscribers\_Adequacy[Region] = GRAPH(Demand\_Adjustment[Region])  
 (0.00, 0.00), (0.1, 0.31), (0.2, 0.515), (0.3, 0.66), (0.4, 0.765), (0.5, 0.85), (0.6, 0.915), (0.7, 0.96), (0.8, 0.985), (0.9, 0.99), (1, 1.00)

Region\_Externality\_Impact[Region] =  
 Region\_Telephone\_Density[Urban]\*Urban\_Weight\_on\_Externality[Region]+Region\_Telephone\_Density[Rural]\*Rural\_Weight\_on\_Externality[Region]

Telecom\_Expenditure\_Increase\_from\_Mobility[Region] =  
 GRAPH(Fraction\_of\_Mobile\_Subscribers[Region])  
 (0.00, 1.00), (0.1, 1.03), (0.2, 1.08), (0.3, 1.17), (0.4, 1.29), (0.5, 1.38), (0.6, 1.45), (0.7, 1.48), (0.8, 1.50), (0.9, 1.50), (1, 1.50)

Telecom\_Expenditure\_Incr\_Size\_of\_the\_Network[Region] =  
 Region\_Externality\_Impact[Region]

Waiting\_List\_Restriction[Region] =  
 GRAPH(Waiting\_List[Region]/(Connecting\_Rate\_Indicated[Region]+Min\_Con\_Rate))  
 (0.00, 0.00), (0.5, 0.035), (1.00, 0.07), (1.50, 0.105), (2.00, 0.145), (2.50, 0.215), (3.00, 0.37), (3.50, 0.65), (4.00, 0.795), (4.50, 0.915), (5.00, 1.00)



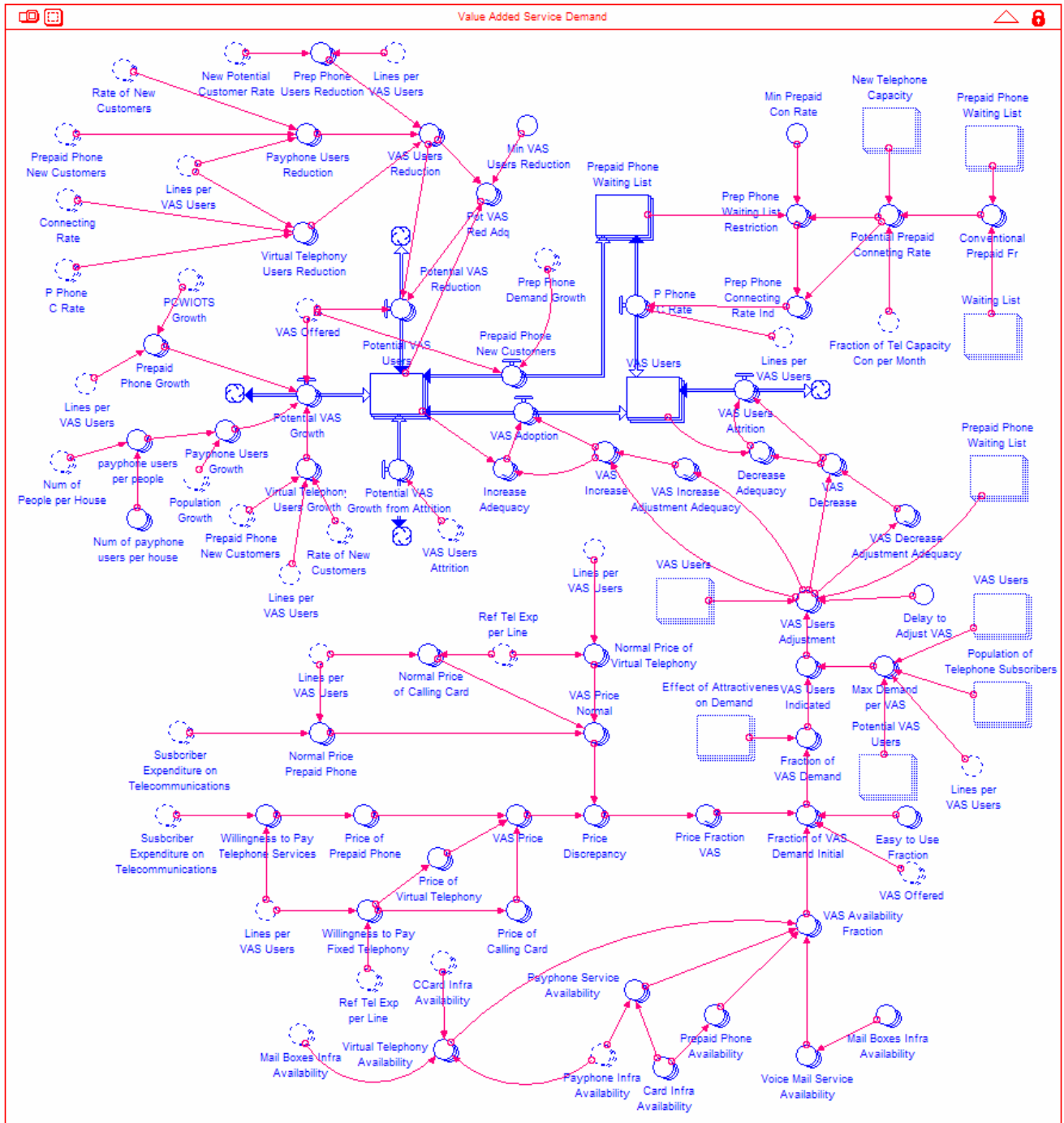
Service\_Time\_Adjustment\_Rate[Service] =  
 (Referential\_Service\_Time\_per\_Line[Service]-  
 Service\_Time\_per\_Line[Service])/Service\_Time\_Adj\_Period[Service]  
 Expenditure\_on\_Traffic\_per\_line[Region] =  
 Normal\_Expenditure\_on\_Traffic[Region]\*Telecom\_Expenditure\_Incr\_Size\_of\_the\_Ne  
 twork[Region]\*Telecom\_Expenditure\_Increase\_from\_Mobility[Region]  
 Exp\_on\_Traffic\_as\_Fraction\_of\_Income[Urban] = 0.010  
 Exp\_on\_Traffic\_as\_Fraction\_of\_Income[Rural] = 0.006  
 Fraction\_of\_\_Expenditure\_per\_\_Service[URLOCAL] = 0.3  
 Fraction\_of\_\_Expenditure\_per\_\_Service[RULOCAL] = 0  
 Fraction\_of\_\_Expenditure\_per\_\_Service[INTERURB] = 0.5  
 Fraction\_of\_\_Expenditure\_per\_\_Service[INTERRUR] = 0.2  
 Fraction\_of\_\_Expenditure\_per\_\_Service[LDURB] = 0.2  
 Fraction\_of\_\_Expenditure\_per\_\_Service[LDRUR] = 0.8  
 Free\_Local\_Minutes\_Used[Urban] = 100  
 Free\_Local\_Minutes\_Used[Rural] = 50  
 Incoming\_International\_Traffic[Urban] =  
 Service\_Time\_per\_Line[INTERURB]\*Incoming\_Outgoing\_International\_Traffic\_Rati  
 o  
 Incoming\_International\_Traffic[Rural] =  
 Service\_Time\_per\_Line[INTERRUR]\*Incoming\_Outgoing\_International\_Traffic\_Rati  
 o  
 Incoming\_Outgoing\_International\_Traffic\_Ratio = 3  
 Indicated\_Traffic\_Expenditure\_per\_Service[URLOCAL] =  
 Expenditure\_on\_Traffic\_per\_line[Urban]\*Fraction\_of\_\_Expenditure\_per\_\_Service[UR  
 LOCAL]  
 Indicated\_Traffic\_Expenditure\_per\_Service[RULOCAL] =  
 Expenditure\_on\_Traffic\_per\_line[Rural]\*Fraction\_of\_\_Expenditure\_per\_\_Service[RU  
 LOCAL]  
 Indicated\_Traffic\_Expenditure\_per\_Service[INTERURB] =  
 Expenditure\_on\_Traffic\_per\_line[Urban]\*Fraction\_of\_\_Expenditure\_per\_\_Service[IN  
 TERURB]  
 Indicated\_Traffic\_Expenditure\_per\_Service[INTERRUR] =  
 Expenditure\_on\_Traffic\_per\_line[Rural]\*Fraction\_of\_\_Expenditure\_per\_\_Service[INT  
 ERRUR]  
 Indicated\_Traffic\_Expenditure\_per\_Service[LDURB] =  
 Expenditure\_on\_Traffic\_per\_line[Urban]\*Fraction\_of\_\_Expenditure\_per\_\_Service[LD  
 URB]  
 Indicated\_Traffic\_Expenditure\_per\_Service[LDRUR] =  
 Expenditure\_on\_Traffic\_per\_line[Rural]\*Fraction\_of\_\_Expenditure\_per\_\_Service[LD  
 RUR]



$\text{Normal\_Expenditure\_on\_Traffic[Region]} = \text{Exp\_on\_Traffic\_as\_Fraction\_of\_Income[Region]} * \text{Monthly\_Income\_per\_Subscriber[Region]}$   
 $\text{Normal\_Monthly\_Rental[Region]} = (\text{W\_t\_Pay\_Telephone\_Service[Region]} - \text{Expenditure\_on\_Traffic\_per\_line[Region]}) * \text{Normal\_Monthly\_Rental\_Adequacy[Region]}$   
 $\text{Price\_of\_Traffic\_per\_Service[URLOCAL]} = 0.014$   
 $\text{Price\_of\_Traffic\_per\_Service[RULOCAL]} = 0.002$   
 $\text{Price\_of\_Traffic\_per\_Service[INTERURB]} = 1$   
 $\text{Price\_of\_Traffic\_per\_Service[INTERRUR]} = 1$   
 $\text{Price\_of\_Traffic\_per\_Service[LDURB]} = 0.042$   
 $\text{Price\_of\_Traffic\_per\_Service[LDRUR]} = 0.006$   
 $\text{Referential\_Service\_Time\_per\_Line[URLOCAL]} = \text{Referential\_Service\_Time\_per\_Line\_Indicated[URLOCAL]} + \text{Free\_Local\_Minutes\_Used[Urban]}$   
 $\text{Referential\_Service\_Time\_per\_Line[RULOCAL]} = \text{Referential\_Service\_Time\_per\_Line\_Indicated[RULOCAL]} + \text{Free\_Local\_Minutes\_Used[Rural]}$   
 $\text{Referential\_Service\_Time\_per\_Line[INTERURB]} = \text{Referential\_Service\_Time\_per\_Line\_Indicated[INTERURB]} + 0 * \text{Free\_Local\_Minutes\_Used[Urban]}$   
 $\text{Referential\_Service\_Time\_per\_Line[INTERRUR]} = \text{Referential\_Service\_Time\_per\_Line\_Indicated[INTERRUR]} + 0 * \text{Free\_Local\_Minutes\_Used[Rural]}$   
 $\text{Referential\_Service\_Time\_per\_Line[LDURB]} = \text{Referential\_Service\_Time\_per\_Line\_Indicated[LDURB]} + 0 * \text{Free\_Local\_Minutes\_Used[Urban]}$   
 $\text{Referential\_Service\_Time\_per\_Line[LDRUR]} = \text{Referential\_Service\_Time\_per\_Line\_Indicated[LDRUR]} + 0 * \text{Free\_Local\_Minutes\_Used[Rural]}$   
 $\text{Referential\_Service\_Time\_per\_Line\_Indicated[URLOCAL]} = (\text{Indicated\_Traffic\_Expenditure\_per\_Service[URLOCAL]} / \text{Price\_of\_Traffic\_per\_Service[URLOCAL]})$   
 $\text{Referential\_Service\_Time\_per\_Line\_Indicated[RULOCAL]} = (\text{Indicated\_Traffic\_Expenditure\_per\_Service[RULOCAL]} / \text{Price\_of\_Traffic\_per\_Service[RULOCAL]})$   
 $\text{Referential\_Service\_Time\_per\_Line\_Indicated[INTERURB]} = \text{Indicated\_Traffic\_Expenditure\_per\_Service[INTERURB]} / \text{Price\_of\_Traffic\_per\_Service[INTERURB]}$   
 $\text{Referential\_Service\_Time\_per\_Line\_Indicated[INTERRUR]} = \text{Indicated\_Traffic\_Expenditure\_per\_Service[INTERRUR]} / \text{Price\_of\_Traffic\_per\_Service[INTERRUR]}$

Referential\_Service\_Time\_per\_Line\_Indicated[LDURB] =  
Indicated\_Traffic\_Expenditure\_per\_Service[LDURB]/Price\_of\_Traffic\_per\_Service[L  
DURB]  
Referential\_Service\_Time\_per\_Line\_Indicated[LDRUR] =  
Indicated\_Traffic\_Expenditure\_per\_Service[LDRUR]/Price\_of\_Traffic\_per\_Service[L  
DRUR]  
Service\_Time\_Adj\_Period[Service] = 12  
W\_t\_Pay\_Telephone\_Service[Region] =  
Subscriber\_\_Expenditure\_on\_Telecommunications\_[Region]  
Normal\_Monthly\_Rental\_Adequacy[Region] =  
GRAPH(W\_t\_Pay\_Telephone\_Service[Region]/Expenditure\_on\_Traffic\_per\_line[Regi  
on])  
(1.00, 0.00), (1.00, 0.295), (1.01, 0.555), (1.01, 0.765), (1.02, 0.87), (1.02, 0.94), (1.03,  
0.96), (1.03, 0.975), (1.04, 0.99), (1.04, 0.995), (1.05, 1.00)

## VALUE ADDED SERVICE DEMAND EQUATIONS:



$$\text{Potential\_VAS\_Users[Virtual\_Telephony,Urban]}(t) = \text{Potential\_VAS\_Users[Virtual\_Telephony,Urban]}(t - dt) +$$

$$\begin{aligned} & (\text{Potential\_VAS\_Growth}[\text{Virtual\_Telephony, Urban}] + \\ & \text{Potential\_VAS\_Growth\_from\_Attrition}[\text{Virtual\_Telephony, Urban}] - \\ & \text{VAS\_Adoption}[\text{Virtual\_Telephony, Urban}] - \\ & \text{Potential\_VAS\_Reduction}[\text{Virtual\_Telephony, Urban}] - \\ & \text{Prepaid\_Phone\_New\_Customers}[\text{Virtual\_Telephony, Urban}]) * dt \\ \text{INIT Potential\_VAS\_Users}[\text{Virtual\_Telephony, Urban}] = & \\ & (\text{Waiting\_List}[\text{Urban}]/\text{Lines\_per\_VAS\_Users} + \text{Prepaid\_Phone\_Waiting\_List}[\text{Urban}]) * \\ & \text{VAS\_Offered}[\text{Virtual\_Telephony, Urban}] \end{aligned}$$

$$\begin{aligned} \text{Potential\_VAS\_Users}[\text{Virtual\_Telephony, Rural}](t) = & \\ \text{Potential\_VAS\_Users}[\text{Virtual\_Telephony, Rural}](t - dt) + & \\ (\text{Potential\_VAS\_Growth}[\text{Virtual\_Telephony, Rural}] + & \\ \text{Potential\_VAS\_Growth\_from\_Attrition}[\text{Virtual\_Telephony, Rural}] - & \\ \text{VAS\_Adoption}[\text{Virtual\_Telephony, Rural}] - & \\ \text{Potential\_VAS\_Reduction}[\text{Virtual\_Telephony, Rural}] - & \\ \text{Prepaid\_Phone\_New\_Customers}[\text{Virtual\_Telephony, Rural}]) * dt & \\ \text{INIT Potential\_VAS\_Users}[\text{Virtual\_Telephony, Rural}] = & \\ (\text{Waiting\_List}[\text{Rural}]/\text{Lines\_per\_VAS\_Users} + \text{Prepaid\_Phone\_Waiting\_List}[\text{Rural}]) * & \\ \text{AS\_Offered}[\text{Virtual\_Telephony, Rural}] & \end{aligned}$$

$$\begin{aligned} \text{Potential\_VAS\_Users}[\text{Payphone, Urban}](t) = & \text{Potential\_VAS\_Users}[\text{Payphone, Urban}](t - dt) + \\ & (\text{Potential\_VAS\_Growth}[\text{Payphone, Urban}] + \\ & \text{Potential\_VAS\_Growth\_from\_Attrition}[\text{Payphone, Urban}] - \\ & \text{VAS\_Adoption}[\text{Payphone, Urban}] - \text{Potential\_VAS\_Reduction}[\text{Payphone, Urban}] - \\ & \text{Prepaid\_Phone\_New\_Customers}[\text{Payphone, Urban}]) * dt \\ \text{INIT Potential\_VAS\_Users}[\text{Payphone, Urban}] = & \\ \text{Population}[\text{Urban}] * \text{payphone\_users\_per\_people}[\text{Urban}] & \end{aligned}$$

$$\begin{aligned} \text{Potential\_VAS\_Users}[\text{Payphone, Rural}](t) = & \text{Potential\_VAS\_Users}[\text{Payphone, Rural}](t - dt) + \\ & (\text{Potential\_VAS\_Growth}[\text{Payphone, Rural}] + \\ & \text{Potential\_VAS\_Growth\_from\_Attrition}[\text{Payphone, Rural}] - \\ & \text{VAS\_Adoption}[\text{Payphone, Rural}] - \text{Potential\_VAS\_Reduction}[\text{Payphone, Rural}] - \\ & \text{Prepaid\_Phone\_New\_Customers}[\text{Payphone, Rural}]) * dt \\ \text{INIT Potential\_VAS\_Users}[\text{Payphone, Rural}] = & \\ \text{Population}[\text{Rural}] * \text{payphone\_users\_per\_people}[\text{Rural}] & \end{aligned}$$

$$\begin{aligned} \text{Potential\_VAS\_Users}[\text{Prepaid\_Phone, Urban}](t) = & \\ \text{Potential\_VAS\_Users}[\text{Prepaid\_Phone, Urban}](t - dt) + & \\ (\text{Potential\_VAS\_Growth}[\text{Prepaid\_Phone, Urban}] + & \\ \text{Potential\_VAS\_Growth\_from\_Attrition}[\text{Prepaid\_Phone, Urban}] - & \\ \text{VAS\_Adoption}[\text{Prepaid\_Phone, Urban}] - & \\ \text{Potential\_VAS\_Reduction}[\text{Prepaid\_Phone, Urban}] - & \\ \text{Prepaid\_Phone\_New\_Customers}[\text{Prepaid\_Phone, Urban}]) * dt & \end{aligned}$$

INIT Potential\_VAS\_Users[Prepaid\_Phone,Urban] =  
 Pot\_Customers\_without\_Interest\_on\_Tel\_Services[Urban]\*VAS\_Offered[Prepaid\_Phone,Urban]

Potential\_VAS\_Users[Prepaid\_Phone,Rural](t) =  
 Potential\_VAS\_Users[Prepaid\_Phone,Rural](t - dt) +  
 (Potential\_VAS\_Growth[Prepaid\_Phone,Rural] +  
 Potential\_VAS\_Growth\_from\_Attrition[Prepaid\_Phone,Rural] -  
 VAS\_Adoption[Prepaid\_Phone,Rural] -  
 Potential\_VAS\_Reduction[Prepaid\_Phone,Rural] -  
 Prepaid\_Phone\_New\_Customers[Prepaid\_Phone,Rural]) \* dt  
 INIT Potential\_VAS\_Users[Prepaid\_Phone,Rural] =  
 Pot\_Customers\_without\_Interest\_on\_Tel\_Services[Rural]\*VAS\_Offered[Prepaid\_Phone,Rural]

INFLOWS:

Potential\_VAS\_Growth[Virtual\_Telephony,Urban] =  
 VAS\_Offered[Virtual\_Telephony,Urban]\*Virtual\_Telephony\_Users\_Growth[Urban]+0\*(Payphone\_Users\_Growth[Urban]+Prepaid\_Phone\_Growth[Urban])  
 Potential\_VAS\_Growth[Virtual\_Telephony,Rural] =  
 VAS\_Offered[Virtual\_Telephony,Rural]\*Virtual\_Telephony\_Users\_Growth[Rural]+0\*(Payphone\_Users\_Growth[Rural]+Prepaid\_Phone\_Growth[Rural])  
 Potential\_VAS\_Growth[Payphone,Urban] =  
 (VAS\_Offered[Payphone,Urban]\*Payphone\_Users\_Growth[Urban])+0\*(Virtual\_Telephony\_Users\_Growth[Urban]+Prepaid\_Phone\_Growth[Urban])  
 Potential\_VAS\_Growth[Payphone,Rural] =  
 VAS\_Offered[Payphone,Rural]\*Payphone\_Users\_Growth[Rural]+0\*(Virtual\_Telephony\_Users\_Growth[Rural]+Prepaid\_Phone\_Growth[Rural])  
 Potential\_VAS\_Growth[Prepaid\_Phone,Urban] =  
 Prepaid\_Phone\_Growth[Urban]\*VAS\_Offered[Prepaid\_Phone,Urban]+0\*(Payphone\_Users\_Growth[Urban]+Virtual\_Telephony\_Users\_Growth[Urban])  
 Potential\_VAS\_Growth[Prepaid\_Phone,Rural] =  
 Prepaid\_Phone\_Growth[Rural]\*VAS\_Offered[Prepaid\_Phone,Rural]+0\*(Virtual\_Telephony\_Users\_Growth[Rural]+Payphone\_Users\_Growth[Rural])  
 Potential\_VAS\_Growth\_from\_Attrition[Virtual\_Telephony,Urban] =  
 VAS\_Users\_Attrition[Virtual\_Telephony,Urban]  
 Potential\_VAS\_Growth\_from\_Attrition[Virtual\_Telephony,Rural] =  
 VAS\_Users\_Attrition[Virtual\_Telephony,Rural]  
 Potential\_VAS\_Growth\_from\_Attrition[Payphone,Urban] =  
 VAS\_Users\_Attrition[Payphone,Urban]  
 Potential\_VAS\_Growth\_from\_Attrition[Payphone,Rural] =  
 VAS\_Users\_Attrition[Payphone,Rural]

Potential\_VAS\_Growth\_from\_Attrition[Prepaid\_Phone,Urban] =  
 0\*VAS\_Users\_Attrition[Prepaid\_Phone,Urban]  
 Potential\_VAS\_Growth\_from\_Attrition[Prepaid\_Phone,Rural] =  
 0\*VAS\_Users\_Attrition[Prepaid\_Phone,Rural]  
 OUTFLOWS:  
 VAS\_Adoption[Virtual\_Telephony,Urban] =  
 VAS\_Increase[Virtual\_Telephony,Urban]\*Increase\_\_Adequacy[Virtual\_Telephony,Urban]  
 VAS\_Adoption[Virtual\_Telephony,Rural] =  
 VAS\_Increase[Virtual\_Telephony,Rural]\*Increase\_\_Adequacy[Virtual\_Telephony,Rural]  
 VAS\_Adoption[Payphone,Urban] =  
 VAS\_Increase[Payphone,Urban]\*Increase\_\_Adequacy[Payphone,Urban]  
 VAS\_Adoption[Payphone,Rural] =  
 VAS\_Increase[Payphone,Rural]\*Increase\_\_Adequacy[Payphone,Rural]  
 VAS\_Adoption[Prepaid\_Phone,Urban] =  
 VAS\_Increase[Prepaid\_Phone,Urban]\*Increase\_\_Adequacy[Prepaid\_Phone,Urban]\*0  
 VAS\_Adoption[Prepaid\_Phone,Rural] =  
 VAS\_Increase[Prepaid\_Phone,Rural]\*Increase\_\_Adequacy[Prepaid\_Phone,Rural]\*0  
 Potential\_VAS\_Reduction[VAS,Region] =  
 VAS\_Users\_Reduction[VAS,Region]\*Pot\_VAS\_Red\_Adq[VAS,Region]\*VAS\_Offered[VAS,Region]  
 Prepaid\_Phone\_New\_Customers[Virtual\_Telephony,Urban] =  
 0\*Prep\_Phone\_Demand\_Growth[Urban]\*VAS\_Offered[Virtual\_Telephony,Urban]  
 Prepaid\_Phone\_New\_Customers[Virtual\_Telephony,Rural] =  
 0\*Prep\_Phone\_Demand\_Growth[Rural]\*VAS\_Offered[Virtual\_Telephony,Rural]  
 Prepaid\_Phone\_New\_Customers[Payphone,Urban] =  
 0\*Prep\_Phone\_Demand\_Growth[Urban]\*VAS\_Offered[Payphone,Urban]  
 Prepaid\_Phone\_New\_Customers[Payphone,Rural] =  
 0\*Prep\_Phone\_Demand\_Growth[Rural]\*VAS\_Offered[Payphone,Rural]  
 Prepaid\_Phone\_New\_Customers[Prepaid\_Phone,Urban] =  
 Prep\_Phone\_Demand\_Growth[Urban]\*VAS\_Offered[Prepaid\_Phone,Urban]  
 Prepaid\_Phone\_New\_Customers[Prepaid\_Phone,Rural] =  
 Prep\_Phone\_Demand\_Growth[Rural]\*VAS\_Offered[Prepaid\_Phone,Rural]  
 Prepaid\_Phone\_Waiting\_List[Region](t) = Prepaid\_Phone\_Waiting\_List[Region](t - dt)  
 + (Prepaid\_Phone\_New\_Customers[VAS,Region] - P\_Phone\_C\_Rate[VAS,Region]) \*  
 dt  
 INIT Prepaid\_Phone\_Waiting\_List[Region] = 0  
 INFLOWS:  
 Prepaid\_Phone\_New\_Customers[Virtual\_Telephony,Urban] =  
 0\*Prep\_Phone\_Demand\_Growth[Urban]\*VAS\_Offered[Virtual\_Telephony,Urban]  
 Prepaid\_Phone\_New\_Customers[Virtual\_Telephony,Rural] =  
 0\*Prep\_Phone\_Demand\_Growth[Rural]\*VAS\_Offered[Virtual\_Telephony,Rural]

$\text{Prepaid\_Phone\_New\_Customers}[\text{Payphone, Urban}] =$   
 $0 * \text{Prep\_Phone\_Demand\_Growth}[\text{Urban}] * \text{VAS\_Offered}[\text{Payphone, Urban}]$   
 $\text{Prepaid\_Phone\_New\_Customers}[\text{Payphone, Rural}] =$   
 $0 * \text{Prep\_Phone\_Demand\_Growth}[\text{Rural}] * \text{VAS\_Offered}[\text{Payphone, Rural}]$   
 $\text{Prepaid\_Phone\_New\_Customers}[\text{Prepaid\_Phone, Urban}] =$   
 $\text{Prep\_Phone\_Demand\_Growth}[\text{Urban}] * \text{VAS\_Offered}[\text{Prepaid\_Phone, Urban}]$   
 $\text{Prepaid\_Phone\_New\_Customers}[\text{Prepaid\_Phone, Rural}] =$   
 $\text{Prep\_Phone\_Demand\_Growth}[\text{Rural}] * \text{VAS\_Offered}[\text{Prepaid\_Phone, Rural}]$

OUTFLOWS:

$\text{P\_Phone\_C\_Rate}[\text{Virtual\_Telephony, Urban}] =$   
 $0 * \text{Prep\_Phone\_Connecting\_Rate\_Ind}[\text{Urban}] / \text{Lines\_per\_VAS\_Users}$   
 $\text{P\_Phone\_C\_Rate}[\text{Virtual\_Telephony, Rural}] =$   
 $0 * \text{Prep\_Phone\_Connecting\_Rate\_Ind}[\text{Rural}] / \text{Lines\_per\_VAS\_Users}$   
 $\text{P\_Phone\_C\_Rate}[\text{Payphone, Urban}] =$   
 $0 * \text{Prep\_Phone\_Connecting\_Rate\_Ind}[\text{Urban}] / \text{Lines\_per\_VAS\_Users}$   
 $\text{P\_Phone\_C\_Rate}[\text{Payphone, Rural}] =$   
 $0 * \text{Prep\_Phone\_Connecting\_Rate\_Ind}[\text{Rural}] / \text{Lines\_per\_VAS\_Users}$   
 $\text{P\_Phone\_C\_Rate}[\text{Prepaid\_Phone, Urban}] =$   
 $\text{Prep\_Phone\_Connecting\_Rate\_Ind}[\text{Urban}] / \text{Lines\_per\_VAS\_Users}$   
 $\text{P\_Phone\_C\_Rate}[\text{Prepaid\_Phone, Rural}] =$   
 $\text{Prep\_Phone\_Connecting\_Rate\_Ind}[\text{Rural}] / \text{Lines\_per\_VAS\_Users}$   
 $\text{VAS\_Users}[\text{Virtual\_Telephony, Urban}](t) = \text{VAS\_Users}[\text{Virtual\_Telephony, Urban}](t -$   
 $dt) + (\text{VAS\_Adoption}[\text{Virtual\_Telephony, Urban}] +$   
 $\text{P\_Phone\_C\_Rate}[\text{Virtual\_Telephony, Urban}] -$   
 $\text{VAS\_Users\_Attrition}[\text{Virtual\_Telephony, Urban}]) * dt$   
 $\text{INIT VAS\_Users}[\text{Virtual\_Telephony, Urban}] = 0$

$\text{VAS\_Users}[\text{Virtual\_Telephony, Rural}](t) = \text{VAS\_Users}[\text{Virtual\_Telephony, Rural}](t -$   
 $dt) + (\text{VAS\_Adoption}[\text{Virtual\_Telephony, Rural}] +$   
 $\text{P\_Phone\_C\_Rate}[\text{Virtual\_Telephony, Rural}] -$   
 $\text{VAS\_Users\_Attrition}[\text{Virtual\_Telephony, Rural}]) * dt$   
 $\text{INIT VAS\_Users}[\text{Virtual\_Telephony, Rural}] = 0$

$\text{VAS\_Users}[\text{Payphone, Urban}](t) = \text{VAS\_Users}[\text{Payphone, Urban}](t - dt) +$   
 $(\text{VAS\_Adoption}[\text{Payphone, Urban}] + \text{P\_Phone\_C\_Rate}[\text{Payphone, Urban}] -$   
 $\text{VAS\_Users\_Attrition}[\text{Payphone, Urban}]) * dt$   
 $\text{INIT VAS\_Users}[\text{Payphone, Urban}] = 0$

$\text{VAS\_Users}[\text{Payphone, Rural}](t) = \text{VAS\_Users}[\text{Payphone, Rural}](t - dt) +$   
 $(\text{VAS\_Adoption}[\text{Payphone, Rural}] + \text{P\_Phone\_C\_Rate}[\text{Payphone, Rural}] -$   
 $\text{VAS\_Users\_Attrition}[\text{Payphone, Rural}]) * dt$   
 $\text{INIT VAS\_Users}[\text{Payphone, Rural}] = 0$

$$\text{VAS\_Users}[\text{Prepaid\_Phone,Urban}](t) = \text{VAS\_Users}[\text{Prepaid\_Phone,Urban}](t - dt) + (\text{VAS\_Adoption}[\text{Prepaid\_Phone,Urban}] + \text{P\_Phone\_C\_Rate}[\text{Prepaid\_Phone,Urban}] - \text{VAS\_Users\_Attrition}[\text{Prepaid\_Phone,Urban}]) * dt$$

$$\text{INIT VAS\_Users}[\text{Prepaid\_Phone,Urban}] = 0$$

$$\text{VAS\_Users}[\text{Prepaid\_Phone,Rural}](t) = \text{VAS\_Users}[\text{Prepaid\_Phone,Rural}](t - dt) + (\text{VAS\_Adoption}[\text{Prepaid\_Phone,Rural}] + \text{P\_Phone\_C\_Rate}[\text{Prepaid\_Phone,Rural}] - \text{VAS\_Users\_Attrition}[\text{Prepaid\_Phone,Rural}]) * dt$$

$$\text{INIT VAS\_Users}[\text{Prepaid\_Phone,Rural}] = 0$$

INFLOWS:

$$\text{VAS\_Adoption}[\text{Virtual\_Telephony,Urban}] = \text{VAS\_Increase}[\text{Virtual\_Telephony,Urban}] * \text{Increase\_Adequacy}[\text{Virtual\_Telephony,Urban}]$$

$$\text{VAS\_Adoption}[\text{Virtual\_Telephony,Rural}] = \text{VAS\_Increase}[\text{Virtual\_Telephony,Rural}] * \text{Increase\_Adequacy}[\text{Virtual\_Telephony,Rural}]$$

$$\text{VAS\_Adoption}[\text{Payphone,Urban}] = \text{VAS\_Increase}[\text{Payphone,Urban}] * \text{Increase\_Adequacy}[\text{Payphone,Urban}]$$

$$\text{VAS\_Adoption}[\text{Payphone,Rural}] = \text{VAS\_Increase}[\text{Payphone,Rural}] * \text{Increase\_Adequacy}[\text{Payphone,Rural}]$$

$$\text{VAS\_Adoption}[\text{Prepaid\_Phone,Urban}] = \text{VAS\_Increase}[\text{Prepaid\_Phone,Urban}] * \text{Increase\_Adequacy}[\text{Prepaid\_Phone,Urban}] * 0$$

$$\text{VAS\_Adoption}[\text{Prepaid\_Phone,Rural}] = \text{VAS\_Increase}[\text{Prepaid\_Phone,Rural}] * \text{Increase\_Adequacy}[\text{Prepaid\_Phone,Rural}] * 0$$

$$\text{P\_Phone\_C\_Rate}[\text{Virtual\_Telephony,Urban}] = 0 * \text{Prep\_Phone\_Connecting\_Rate\_Ind}[\text{Urban}] / \text{Lines\_per\_VAS\_Users}$$

$$\text{P\_Phone\_C\_Rate}[\text{Virtual\_Telephony,Rural}] = 0 * \text{Prep\_Phone\_Connecting\_Rate\_Ind}[\text{Rural}] / \text{Lines\_per\_VAS\_Users}$$

$$\text{P\_Phone\_C\_Rate}[\text{Payphone,Urban}] = 0 * \text{Prep\_Phone\_Connecting\_Rate\_Ind}[\text{Urban}] / \text{Lines\_per\_VAS\_Users}$$

$$\text{P\_Phone\_C\_Rate}[\text{Payphone,Rural}] = 0 * \text{Prep\_Phone\_Connecting\_Rate\_Ind}[\text{Rural}] / \text{Lines\_per\_VAS\_Users}$$

$$\text{P\_Phone\_C\_Rate}[\text{Prepaid\_Phone,Urban}] = \text{Prep\_Phone\_Connecting\_Rate\_Ind}[\text{Urban}] / \text{Lines\_per\_VAS\_Users}$$

$$\text{P\_Phone\_C\_Rate}[\text{Prepaid\_Phone,Rural}] = \text{Prep\_Phone\_Connecting\_Rate\_Ind}[\text{Rural}] / \text{Lines\_per\_VAS\_Users}$$

OUTFLOWS:

$$\text{VAS\_Users\_Attrition}[\text{VAS,Region}] = \text{VAS\_Decrease}[\text{VAS,Region}] * \text{Decrease\_Adequacy}[\text{VAS,Region}]$$

$$\text{CCard\_Infra\_Availability}[\text{Region}] = 1$$

$$\text{Conventional\_Prepaid\_Fr}[\text{Region}] = \text{Waiting\_List}[\text{Region}] / (\text{Prepaid\_Phone\_Waiting\_List}[\text{Region}] + \text{Waiting\_List}[\text{Region}])$$



$\text{Delay\_to\_Adjust\_VAS} = 3$   
 $\text{Easy\_to\_Use\_Fraction}[\text{Virtual\_Telephony, Urban}] = 0.4$   
 $\text{Easy\_to\_Use\_Fraction}[\text{Virtual\_Telephony, Rural}] = 0.2$   
 $\text{Easy\_to\_Use\_Fraction}[\text{Payphone, Urban}] = 0.7$   
 $\text{Easy\_to\_Use\_Fraction}[\text{Payphone, Rural}] = 0.4$   
 $\text{Easy\_to\_Use\_Fraction}[\text{Prepaid\_Phone, Urban}] = 1$   
 $\text{Easy\_to\_Use\_Fraction}[\text{Prepaid\_Phone, Rural}] = 1$   
 $\text{Fraction\_of\_VAS\_Demand}[\text{Virtual\_Telephony, Urban}] =$   
 $\text{Fraction\_of\_VAS\_Demand\_Initial}[\text{Virtual\_Telephony, Urban}] + 0 * \text{Effect\_of\_Attractiveness\_on\_Demand}[\text{Urban}]$   
 $\text{Fraction\_of\_VAS\_Demand}[\text{Virtual\_Telephony, Rural}] =$   
 $\text{Fraction\_of\_VAS\_Demand\_Initial}[\text{Virtual\_Telephony, Rural}] + 0 * \text{Effect\_of\_Attractiveness\_on\_Demand}[\text{Rural}]$   
 $\text{Fraction\_of\_VAS\_Demand}[\text{Payphone, Urban}] =$   
 $\text{Fraction\_of\_VAS\_Demand\_Initial}[\text{Payphone, Urban}] * \text{Effect\_of\_Attractiveness\_on\_Demand}[\text{Urban}]$   
 $\text{Fraction\_of\_VAS\_Demand}[\text{Payphone, Rural}] =$   
 $\text{Fraction\_of\_VAS\_Demand\_Initial}[\text{Payphone, Rural}] * \text{Effect\_of\_Attractiveness\_on\_Demand}[\text{Rural}]$   
 $\text{Fraction\_of\_VAS\_Demand}[\text{Prepaid\_Phone, Urban}] =$   
 $\text{Fraction\_of\_VAS\_Demand\_Initial}[\text{Prepaid\_Phone, Urban}] * \text{Effect\_of\_Attractiveness\_on\_Demand}[\text{Urban}]$   
 $\text{Fraction\_of\_VAS\_Demand}[\text{Prepaid\_Phone, Rural}] =$   
 $\text{Fraction\_of\_VAS\_Demand\_Initial}[\text{Prepaid\_Phone, Rural}] * \text{Effect\_of\_Attractiveness\_on\_Demand}[\text{Rural}]$   
 $\text{Fraction\_of\_VAS\_Demand\_Initial}[\text{VAS, Region}] =$   
 $\text{Price\_Fraction\_VAS}[\text{VAS, Region}] * \text{Easy\_to\_Use\_Fraction}[\text{VAS, Region}] * \text{VAS\_Availability\_Fraction}[\text{VAS, Region}] * \text{VAS\_Offered}[\text{VAS, Region}]$   
 $\text{Mail\_Boxes\_Infra\_Availability}[\text{Region}] = 1$   
 $\text{Max\_Demand\_per\_VAS}[\text{Virtual\_Telephony, Urban}] =$   
 $\text{Potential\_VAS\_Users}[\text{Virtual\_Telephony, Urban}] + \text{VAS\_Users}[\text{Virtual\_Telephony, Urban}] + 0 * \text{Population\_of\_Telephone\_Subscribers}[\text{Urban}] / \text{Lines\_per\_VAS\_Users}$   
 $\text{Max\_Demand\_per\_VAS}[\text{Virtual\_Telephony, Rural}] =$   
 $(\text{Potential\_VAS\_Users}[\text{Virtual\_Telephony, Rural}] + \text{VAS\_Users}[\text{Virtual\_Telephony, Rural}]) + 0 * \text{Population\_of\_Telephone\_Subscribers}[\text{Rural}] / \text{Lines\_per\_VAS\_Users}$   
 $\text{Max\_Demand\_per\_VAS}[\text{Payphone, Urban}] =$   
 $(\text{Potential\_VAS\_Users}[\text{Payphone, Urban}] + \text{VAS\_Users}[\text{Payphone, Urban}]) + 0 * \text{Population\_of\_Telephone\_Subscribers}[\text{Urban}] / \text{Lines\_per\_VAS\_Users}$   
 $\text{Max\_Demand\_per\_VAS}[\text{Payphone, Rural}] =$   
 $\text{Potential\_VAS\_Users}[\text{Payphone, Rural}] + \text{VAS\_Users}[\text{Payphone, Rural}] + 0 * \text{Population\_of\_Telephone\_Subscribers}[\text{Rural}] / \text{Lines\_per\_VAS\_Users}$

$$\text{Max\_Demand\_per\_VAS[Prepaid\_Phone,Urban]} = \frac{\text{Population\_of\_Telephone\_Subscribers[Urban]}}{\text{Lines\_per\_VAS\_Users}+0} * (\text{Potential\_VAS\_Users[Prepaid\_Phone,Urban]} + \text{VAS\_Users[Prepaid\_Phone,Urban]})$$

$$\text{Max\_Demand\_per\_VAS[Prepaid\_Phone,Rural]} = \frac{\text{Population\_of\_Telephone\_Subscribers[Rural]}}{\text{Lines\_per\_VAS\_Users}+0} * (\text{Potential\_VAS\_Users[Prepaid\_Phone,Rural]} + \text{VAS\_Users[Prepaid\_Phone,Rural]})$$

$$\text{Min\_Prepaid\_Con\_Rate} = 1$$

$$\text{Min\_VAS\_Users\_Reduction} = 1$$

$$\text{Normal\_Price\_of\_Virtual\_Telephony[Region]} = \frac{\text{Ref\_Tel\_Exp\_per\_Line[Region]} * \text{Lines\_per\_VAS\_Users}}{\text{Subscriber\_Expenditure\_on\_Telecommunications\_ [Region]} * \text{Lines\_per\_VAS\_Users}}$$

$$\text{Normal\_Price\_of\_Calling\_Card[Region]} = \frac{\text{Ref\_Tel\_Exp\_per\_Line[Region]} * \text{Lines\_per\_VAS\_Users}}{\text{Num\_of\_payphone\_users\_per\_house[Region]}}$$

$$\text{Num\_of\_payphone\_users\_per\_house[Region]} = 2$$

$$\text{Payphone\_Service\_Availability[Region]} = \frac{\text{Payphone\_Infra\_Availability[Region]} * \text{CCard\_Infra\_Availability[Region]}}{\text{Payphone\_Users\_Growth[Region]}}$$

$$\text{Population\_Growth[Region]} * \text{payphone\_users\_per\_people[Region]}$$

$$\text{payphone\_users\_per\_people[Region]} = \frac{\text{Num\_of\_payphone\_users\_per\_house[Region]}}{\text{Num\_of\_People\_per\_House[Region]}}$$

$$\text{Payphone\_Users\_Reduction[Region]} = \frac{\text{Rate\_of\_New\_Customers[Region]}}{\text{Lines\_per\_VAS\_Users}} + \text{Prepaid\_Phone\_New\_Customers[Prepaid\_Phone, Region]}$$

$$\text{Potential\_Prepaid\_Conneting\_Rate[Region]} = \frac{\text{New\_Telephone\_Capacity[Region]} * \text{Fraction\_of\_Tel\_Capacity\_Con\_per\_Month} * (1 - \text{Conventional\_Prepaid\_Fr[Region]})}{\text{Pot\_VAS\_Red\_Adq[VAS,Region]}}$$

$$\text{Pot\_VAS\_Red\_Adq[VAS,Region]} = \frac{\text{Potential\_VAS\_Users[VAS,Region]}}{(\text{VAS\_Users\_Reduction[VAS,Region]} + \text{Min\_VAS\_Users\_Reduction})}$$

$$\text{Prepaid\_Phone\_Availability[Region]} = \text{CCard\_Infra\_Availability[Region]}$$

$$\text{Prepaid\_Phone\_Growth[Region]} = \frac{\text{PCWIOTS\_Growth[Region]}}{\text{Lines\_per\_VAS\_Users}}$$

$$\text{Prep\_Phone\_Connecting\_Rate\_Ind[Region]} = \frac{\text{Potential\_Prepaid\_Conneting\_Rate[Region]} * \text{Prep\_Phone\_Waiting\_List\_Restriction[Region]}}{\text{Prep\_Phone\_Users\_Reduction[Region]}}$$

$$\text{Prep\_Phone\_Users\_Reduction[Region]} = \frac{\text{New\_Potential\_Customer\_Rate[Region]}}{\text{Lines\_per\_VAS\_Users}}$$

$$\text{Price\_of\_Calling\_Card[Region]} = \text{Willingness\_to\_Pay\_Fixed\_Telephony[Region]}$$

$$\text{Price\_of\_Prepaid\_Phone[Region]} = \text{Willingness\_to\_Pay\_Telephone\_Services[Region]}$$

$$\text{Price\_of\_Virtual\_Telephony[Region]} = \text{Willingness\_to\_Pay\_Fixed\_Telephony[Region]}$$

$$\text{Price\_Discrepancy[VAS,Region]} = \frac{\text{VAS\_Price[VAS,Region]}}{\text{VAS\_Price\_Normal[VAS,Region]}}$$

$$\text{VAS\_Availability\_Fraction}[\text{Virtual\_Telephony, Urban}] = \text{Virtual\_Telephony\_Availability}[\text{Urban}] + 0 * \text{Payphone\_Service\_Availability}[\text{Urban}] * \text{Voice\_Mail\_Service\_Availability}[\text{Urban}] * \text{Prepaid\_Phone\_Availability}[\text{Urban}]$$

$$\text{VAS\_Availability\_Fraction}[\text{Virtual\_Telephony, Rural}] = \text{Virtual\_Telephony\_Availability}[\text{Rural}] + 0 * \text{Payphone\_Service\_Availability}[\text{Rural}] * \text{Voice\_Mail\_Service\_Availability}[\text{Rural}] * \text{Prepaid\_Phone\_Availability}[\text{Rural}]$$

$$\text{VAS\_Availability\_Fraction}[\text{Payphone, Urban}] = \text{Payphone\_Service\_Availability}[\text{Urban}] + 0 * \text{Voice\_Mail\_Service\_Availability}[\text{Urban}] * \text{Virtual\_Telephony\_Availability}[\text{Urban}] * \text{Prepaid\_Phone\_Availability}[\text{Urban}]$$

$$\text{VAS\_Availability\_Fraction}[\text{Payphone, Rural}] = \text{Payphone\_Service\_Availability}[\text{Rural}] + 0 * \text{Voice\_Mail\_Service\_Availability}[\text{Rural}] * \text{Virtual\_Telephony\_Availability}[\text{Rural}] * \text{Prepaid\_Phone\_Availability}[\text{Rural}]$$

$$\text{VAS\_Availability\_Fraction}[\text{Prepaid\_Phone, Urban}] = \text{Prepaid\_Phone\_Availability}[\text{Urban}] + 0 * \text{Payphone\_Service\_Availability}[\text{Urban}] * \text{Voice\_Mail\_Service\_Availability}[\text{Urban}] * \text{Virtual\_Telephony\_Availability}[\text{Urban}]$$

$$\text{VAS\_Availability\_Fraction}[\text{Prepaid\_Phone, Rural}] = \text{Prepaid\_Phone\_Availability}[\text{Rural}] + 0 * \text{Payphone\_Service\_Availability}[\text{Rural}] * \text{Voice\_Mail\_Service\_Availability}[\text{Rural}] * \text{Virtual\_Telephony\_Availability}[\text{Rural}]$$

$$\text{VAS\_Increase}[\text{VAS, Region}] = \text{VAS\_Users\_Adjustment}[\text{VAS, Region}] * \text{VAS\_Increase\_Adjustment\_Adequacy}[\text{VAS, Region}]$$

$$\text{VAS\_Price}[\text{Virtual\_Telephony, Urban}] = \text{Price\_of\_Virtual\_Telephony}[\text{Urban}] + 0 * \text{Price\_of\_Calling\_Card}[\text{Urban}] * \text{Price\_of\_Prepaid\_Phone}[\text{Urban}]$$

$$\text{VAS\_Price}[\text{Virtual\_Telephony, Rural}] = \text{Price\_of\_Virtual\_Telephony}[\text{Rural}] + 0 * \text{Price\_of\_Calling\_Card}[\text{Rural}] * \text{Price\_of\_Prepaid\_Phone}[\text{Rural}]$$

$$\text{VAS\_Price}[\text{Payphone, Urban}] = \text{Price\_of\_Calling\_Card}[\text{Urban}] + 0 * \text{Price\_of\_Virtual\_Telephony}[\text{Urban}] * \text{Price\_of\_Prepaid\_Phone}[\text{Urban}]$$

$$\text{VAS\_Price}[\text{Payphone, Rural}] = \text{Price\_of\_Calling\_Card}[\text{Rural}] + 0 * \text{Price\_of\_Virtual\_Telephony}[\text{Rural}] * \text{Price\_of\_Prepaid\_Phone}[\text{Rural}]$$

$$\text{VAS\_Price}[\text{Prepaid\_Phone, Urban}] = \text{Price\_of\_Prepaid\_Phone}[\text{Urban}] + 0 * \text{Price\_of\_Calling\_Card}[\text{Urban}] * \text{Price\_of\_Virtual\_Telephony}[\text{Urban}]$$

$$\text{VAS\_Price}[\text{Prepaid\_Phone, Rural}] = \text{Price\_of\_Prepaid\_Phone}[\text{Rural}] + 0 * \text{Price\_of\_Calling\_Card}[\text{Rural}] * \text{Price\_of\_Virtual\_Telephony}[\text{Rural}]$$

$$\text{VAS\_Price\_Normal}[\text{Virtual\_Telephony, Urban}] = \text{Normal\_Price\_of\_Virtual\_Telephony}[\text{Urban}] + 0 * (\text{Normal\_Price\_of\_Calling\_Card}[\text{Urban}] + \text{Normal\_Price\_Prepaid\_Phone}[\text{Urban}])$$

$$\text{VAS\_Price\_Normal}[\text{Virtual\_Telephony},\text{Rural}] = \text{Normal\_Price\_of\_Virtual\_Telephony}[\text{Rural}] + 0 * (\text{Normal\_Price\_of\_Calling\_Card}[\text{Rural}] + \text{Normal\_Price\_Prepaid\_Phone}[\text{Rural}])$$

$$\text{VAS\_Price\_Normal}[\text{Payphone},\text{Urban}] = \text{Normal\_Price\_of\_Calling\_Card}[\text{Urban}] + 0 * (\text{Normal\_Price\_of\_Virtual\_Telephony}[\text{Urban}] + \text{Normal\_Price\_Prepaid\_Phone}[\text{Urban}])$$

$$\text{VAS\_Price\_Normal}[\text{Payphone},\text{Rural}] = \text{Normal\_Price\_of\_Calling\_Card}[\text{Rural}] + 0 * (\text{Normal\_Price\_of\_Virtual\_Telephony}[\text{Rural}] + \text{Normal\_Price\_Prepaid\_Phone}[\text{Rural}])$$

$$\text{VAS\_Price\_Normal}[\text{Prepaid\_Phone},\text{Urban}] = \text{Normal\_Price\_Prepaid\_Phone}[\text{Urban}] + 0 * (\text{Normal\_Price\_of\_Virtual\_Telephony}[\text{Urban}] + \text{Normal\_Price\_of\_Calling\_Card}[\text{Urban}])$$

$$\text{VAS\_Price\_Normal}[\text{Prepaid\_Phone},\text{Rural}] = \text{Normal\_Price\_Prepaid\_Phone}[\text{Rural}] + 0 * (\text{Normal\_Price\_of\_Virtual\_Telephony}[\text{Rural}] + \text{Normal\_Price\_of\_Calling\_Card}[\text{Rural}])$$

$$\text{VAS\_Users\_Adjustment}[\text{Virtual\_Telephony},\text{Urban}] = ((\text{VAS\_Users\_Indicated}[\text{Virtual\_Telephony},\text{Urban}] - \text{VAS\_Users}[\text{Virtual\_Telephony},\text{Urban}]) / \text{Delay\_to\_Adjust\_VAS}) + 0 * \text{Prepaid\_Phone\_Waiting\_List}[\text{Urban}]$$

$$\text{VAS\_Users\_Adjustment}[\text{Virtual\_Telephony},\text{Rural}] = (\text{VAS\_Users\_Indicated}[\text{Virtual\_Telephony},\text{Rural}] - \text{VAS\_Users}[\text{Virtual\_Telephony},\text{Rural}]) / (\text{Delay\_to\_Adjust\_VAS}) + 0 * \text{Prepaid\_Phone\_Waiting\_List}[\text{Rural}]$$

$$\text{VAS\_Users\_Adjustment}[\text{Payphone},\text{Urban}] = ((\text{VAS\_Users\_Indicated}[\text{Payphone},\text{Urban}] - \text{VAS\_Users}[\text{Payphone},\text{Urban}]) / \text{Delay\_to\_Adjust\_VAS}) + 0 * \text{Prepaid\_Phone\_Waiting\_List}[\text{Urban}]$$

$$\text{VAS\_Users\_Adjustment}[\text{Payphone},\text{Rural}] = ((\text{VAS\_Users\_Indicated}[\text{Payphone},\text{Rural}] - \text{VAS\_Users}[\text{Payphone},\text{Rural}]) / \text{Delay\_to\_Adjust\_VAS}) + 0 * \text{Prepaid\_Phone\_Waiting\_List}[\text{Rural}]$$

$$\text{VAS\_Users\_Adjustment}[\text{Prepaid\_Phone},\text{Urban}] = (\text{VAS\_Users\_Indicated}[\text{Prepaid\_Phone},\text{Urban}] - \text{VAS\_Users}[\text{Prepaid\_Phone},\text{Urban}] - \text{Prepaid\_Phone\_Waiting\_List}[\text{Urban}]) / \text{Delay\_to\_Adjust\_VAS}$$

$$\text{VAS\_Users\_Adjustment}[\text{Prepaid\_Phone},\text{Rural}] = (\text{VAS\_Users\_Indicated}[\text{Prepaid\_Phone},\text{Rural}] - \text{VAS\_Users}[\text{Prepaid\_Phone},\text{Rural}] - \text{Prepaid\_Phone\_Waiting\_List}[\text{Rural}]) / \text{Delay\_to\_Adjust\_VAS}$$

$$\text{VAS\_Users\_Indicated}[\text{VAS},\text{Region}] = \text{Max\_Demand\_per\_VAS}[\text{VAS},\text{Region}] * \text{Fraction\_of\_VAS\_Demand}[\text{VAS},\text{Region}]$$

$$\text{VAS\_Users\_Reduction}[\text{Virtual\_Telephony},\text{Urban}] = \text{Virtual\_Telephony\_Users\_Reduction}[\text{Urban}] + 0 * (\text{Payphone\_Users\_Reduction}[\text{Urban}] + \text{Prep\_Phone\_Users\_Reduction}[\text{Urban}])$$

$$\text{VAS\_Users\_Reduction}[\text{Virtual\_Telephony},\text{Rural}] = \text{Virtual\_Telephony\_Users\_Reduction}[\text{Rural}] + 0 * (\text{Payphone\_Users\_Reduction}[\text{Rural}] + \text{Prep\_Phone\_Users\_Reduction}[\text{Rural}])$$

$$\text{VAS\_Users\_Reduction}[\text{Payphone},\text{Urban}] = \text{Payphone\_Users\_Reduction}[\text{Urban}] + 0 * (\text{Virtual\_Telephony\_Users\_Reduction}[\text{Urban}] + \text{Prep\_Phone\_Users\_Reduction}[\text{Urban}])$$

$$\text{VAS\_Users\_Reduction}[\text{Payphone},\text{Rural}] = \text{Payphone\_Users\_Reduction}[\text{Rural}] + 0 * (\text{Virtual\_Telephony\_Users\_Reduction}[\text{Rural}] + \text{Prep\_Phone\_Users\_Reduction}[\text{Rural}])$$

$$\text{VAS\_Users\_Reduction}[\text{Prepaid\_Phone},\text{Urban}] = \text{Prep\_Phone\_Users\_Reduction}[\text{Urban}] + 0 * (\text{Virtual\_Telephony\_Users\_Reduction}[\text{Urban}] + \text{Payphone\_Users\_Reduction}[\text{Urban}])$$

$$\text{VAS\_Users\_Reduction}[\text{Prepaid\_Phone},\text{Rural}] = \text{Prep\_Phone\_Users\_Reduction}[\text{Rural}] + 0 * (\text{Payphone\_Users\_Reduction}[\text{Rural}] + \text{Virtual\_Telephony\_Users\_Reduction}[\text{Rural}])$$

$$\text{VAS\_Decrease}[\text{VAS},\text{Region}] = \text{VAS\_Decrease\_Adjustment\_Adequacy}[\text{VAS},\text{Region}] * \text{VAS\_Users\_Adjustment}[\text{VAS},\text{Region}]$$

$$\text{Virtual\_Telephony\_Availability}[\text{Region}] = \text{Payphone\_Infra\_Availability}[\text{Region}] * \text{CCard\_Infra\_Availability}[\text{Region}] * \text{Mail\_Boxes\_Infra\_Availability}[\text{Region}]$$

$$\text{Virtual\_Telephony\_Users\_Growth}[\text{Region}] = \frac{\text{Rate\_of\_New\_Customers}[\text{Region}]}{\text{Lines\_per\_VAS\_Users} + \text{Prepaid\_Phone\_New\_Customers}[\text{Prepaid\_Phone},\text{Region}]}$$

$$\text{Virtual\_Telephony\_Users\_Reduction}[\text{Region}] = \frac{\text{Connecting\_Rate}[\text{Region}]}{\text{Lines\_per\_VAS\_Users} + \text{P\_Phone\_C\_Rate}[\text{Prepaid\_Phone},\text{Region}]}$$

$$\text{Voice\_Mail\_Service\_Availability}[\text{Region}] = \text{Mail\_Boxes\_Infra\_Availability}[\text{Region}]$$

$$\text{Willingness\_to\_Pay\_Fixed\_Telephony}[\text{Region}] = \text{Ref\_Tel\_Exp\_per\_Line}[\text{Region}] * \text{Lines\_per\_VAS\_Users}$$

$$\text{Willingness\_to\_Pay\_Telephone\_Services}[\text{Region}] = \text{Subscriber\_Expenditure\_on\_Telecommunications}[\text{Region}] * \text{Lines\_per\_VAS\_Users}$$

$$\text{Decrease\_Adequacy}[\text{VAS},\text{Region}] = \text{GRAPH}(\text{VAS\_Users}[\text{VAS},\text{Region}] / (\text{VAS\_Decrease}[\text{VAS},\text{Region}] + 1))$$

(0.00, 0.00), (0.4, 0.205), (0.8, 0.43), (1.20, 0.61), (1.60, 0.77), (2.00, 0.875), (2.40, 0.95), (2.80, 0.985), (3.20, 0.99), (3.60, 1.00), (4.00, 1.00)

$$\text{Increase\_Adequacy}[\text{VAS},\text{Region}] = \text{GRAPH}(\text{Potential\_VAS\_Users}[\text{VAS},\text{Region}] / (\text{VAS\_Increase}[\text{VAS},\text{Region}] + 1))$$

(0.00, 0.00), (0.4, 0.01), (0.8, 0.04), (1.20, 0.105), (1.60, 0.22), (2.00, 0.5), (2.40, 0.8), (2.80, 0.935), (3.20, 0.985), (3.60, 0.995), (4.00, 1.00)

$$\text{Pot\_VAS\_Red\_Adq}[\text{VAS},\text{Region}] = \frac{\text{Potential\_VAS\_Users}[\text{VAS},\text{Region}]}{\text{VAS\_Users\_Reduction}[\text{VAS},\text{Region}] + \text{Min\_VAS\_Users\_Reduction}}$$

Prep\_Phone\_\_Waiting\_List\_Restriction[Region] =  
 GRAPH(Prepaid\_Phone\_Waiting\_List[Region]/(Potential\_Prepaid\_Conneting\_Rate[Region]+Min\_Prepaid\_Con\_Rate))  
 (0.00, 0.00), (1.00, 0.33), (2.00, 0.565), (3.00, 0.715), (4.00, 0.835), (5.00, 0.9), (6.00, 0.96), (7.00, 0.985), (8.00, 1.00), (9.00, 1.00), (10.0, 1.00)  
 Price\_Fraction\_VAS[VAS,Region] = GRAPH(Price\_Discrepancy[VAS,Region])  
 (1.00, 1.00), (1.20, 0.97), (1.40, 0.945), (1.60, 0.895), (1.80, 0.825), (2.00, 0.755), (2.20, 0.665), (2.40, 0.57), (2.60, 0.44), (2.80, 0.245), (3.00, 0.00)  
 VAS\_Decrease\_Adjustment\_Adequacy[VAS,Region] =  
 GRAPH(VAS\_Users\_Adjustment[VAS,Region])  
 (-1.00, -1.00), (-0.9, -0.975), (-0.8, -0.935), (-0.7, -0.875), (-0.6, -0.745), (-0.5, -0.505), (-0.4, -0.285), (-0.3, -0.165), (-0.2, -0.09), (-0.1, -0.035), (-1.39e-016, 0.00)  
 VAS\_Increase\_Adjustment\_Adequacy[VAS,Region] =  
 GRAPH(VAS\_Users\_Adjustment[VAS,Region])  
 (0.00, 0.00), (0.1, 0.215), (0.2, 0.415), (0.3, 0.565), (0.4, 0.695), (0.5, 0.785), (0.6, 0.85), (0.7, 0.905), (0.8, 0.95), (0.9, 0.99), (1, 1.00)



$\text{Payphone\_Deployment\_in\_Progress}[\text{VAS\_Infrastructure,Region}](t) =$   
 $\text{Payphone\_Deployment\_in\_Progress}[\text{VAS\_Infrastructure,Region}](t - dt) +$   
 $(\text{New\_Orders\_of\_Payphone\_Deployment}[\text{VAS\_Infrastructure,Region}] -$   
 $\text{Payphone\_Deployment\_Rate}[\text{VAS\_Infrastructure,Region}]) * dt$   
 INIT  $\text{Payphone\_Deployment\_in\_Progress}[\text{VAS\_Infrastructure,Region}] = 0$

INFLOWS:

$\text{New\_Orders\_of\_Payphone\_Deployment}[\text{VAS\_Infrastructure,Region}] =$   
 $\text{Payphone\_Infra\_Adjustment}[\text{VAS\_Infrastructure,Region}] * \text{Payphone\_Ordering\_Adequacy}[\text{VAS\_Infrastructure,Region}]$

OUTFLOWS:

$\text{Payphone\_Deployment\_Rate}[\text{VAS\_Infrastructure,Region}] =$   
 $\text{Payphone\_Deployment\_in\_Progress}[\text{VAS\_Infrastructure,Region}] / \text{Payphone\_Deployment\_Delay}[\text{Region}]$

$\text{Payphone\_Installed}[\text{Payphones,Urban}](t) = \text{Payphone\_Installed}[\text{Payphones,Urban}](t - dt) +$   
 $(\text{Payphone\_Deployment\_Rate}[\text{Payphones,Urban}] - \text{Payphone\_Discard\_Rate}[\text{Payphones,Urban}]) * dt$

INIT  $\text{Payphone\_Installed}[\text{Payphones,Urban}] = 0$

$\text{Payphone\_Installed}[\text{Payphones,Rural}](t) = \text{Payphone\_Installed}[\text{Payphones,Rural}](t - dt) +$   
 $(\text{Payphone\_Deployment\_Rate}[\text{Payphones,Rural}] - \text{Payphone\_Discard\_Rate}[\text{Payphones,Rural}]) * dt$

INIT  $\text{Payphone\_Installed}[\text{Payphones,Rural}] = 0$

INFLOWS:

$\text{Payphone\_Deployment\_Rate}[\text{VAS\_Infrastructure,Region}] =$   
 $\text{Payphone\_Deployment\_in\_Progress}[\text{VAS\_Infrastructure,Region}] / \text{Payphone\_Deployment\_Delay}[\text{Region}]$

OUTFLOWS:

$\text{Payphone\_Discard\_Rate}[\text{VAS\_Infrastructure,Region}] =$   
 $\text{Payphone\_Discard\_Adequacy}[\text{VAS\_Infrastructure,Region}] * \text{Payphone\_Infra\_Discarded}[\text{VAS\_Infrastructure,Region}]$

$\text{Cost\_Calling\_Card\_Number} = 5$

$\text{Cost\_of\_each\_Mail\_Box} = 10$

$\text{Cost\_of\_each\_Payphone}[\text{Region}] =$

$\text{Cost\_of\_Payphone\_Devices} + \text{Cost\_of\_Telephone\_Line}[\text{Region}] * \text{T\_Lines\_per\_Payphone}$

$\text{Cost\_of\_Payphone\_Devices} = 500$

$\text{Delay\_to\_Adjust\_Payphone\_Infra}[\text{VAS\_Infrastructure,Region}] = 3$

$\text{Desired\_Payphone\_Infra}[\text{VAS\_Infrastructure,Region}] =$

$\text{Supplied\_Payphone\_Infra}[\text{VAS\_Infrastructure,Region}] -$

$\text{Supplied\_Payphone\_Adequacy}[\text{VAS\_Infrastructure,Region}] * (\text{Supplied\_Payphone\_Infra}[\text{VAS\_Infrastructure,Region}] -$

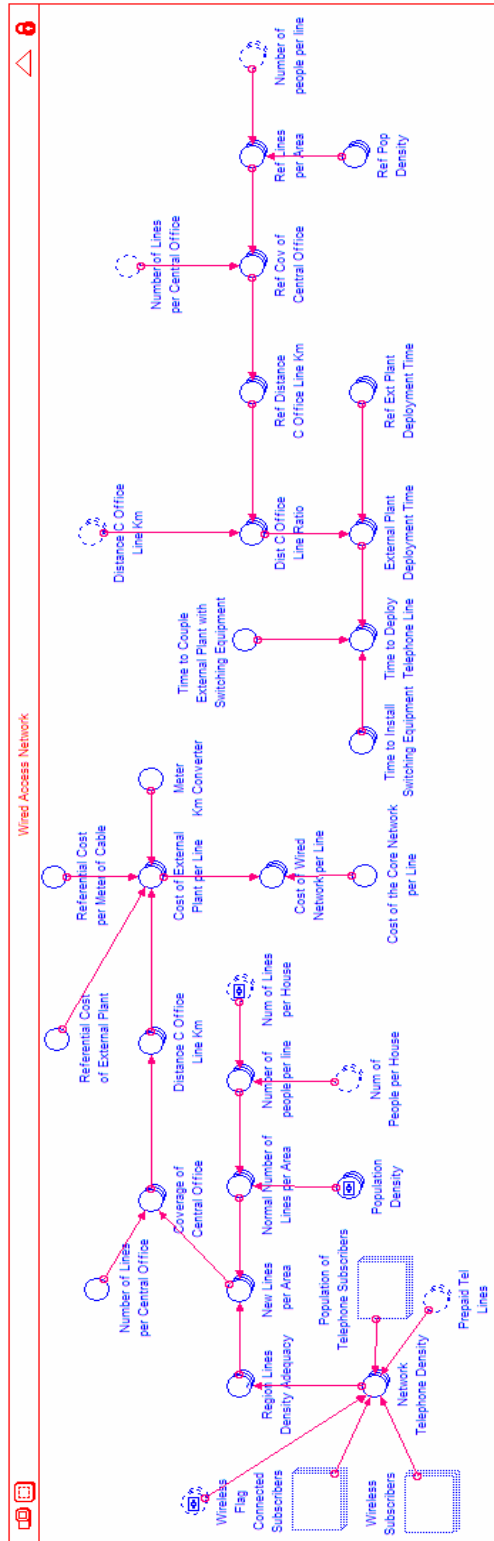
$\text{Maximum\_Payphone\_Infra}[\text{VAS\_Infrastructure,Region}])$



$Maximum\_Payphone\_Infra[Payphones, Urban] = IF(VAS\_Offered[Payphone, Urban] = 1 \text{ OR } VAS\_Offered[Virtual\_Telephony, Urban] = 1) \text{ THEN}$   
 $(Ref\_Payphone\_Users[Urban]*Payphone\_Infrastructure\_per\_Users*Payphone\_Availability\_Referential) \text{ ELSE } (0)$   
 $Maximum\_Payphone\_Infra[Payphones, Rural] = IF(VAS\_Offered[Payphone, Rural] = 1 \text{ OR } VAS\_Offered[Virtual\_Telephony, Rural] = 1)$   
 $\text{ THEN}(Ref\_Payphone\_Users[Rural]*Payphone\_Infrastructure\_per\_Users*Payphone\_Availability\_Referential) \text{ ELSE}(0)$   
 $Min\_VAS\_Infra = 1$   
 $Payphone\_Availability\_Referential = 3/1000$   
 $Payphone\_Deployment\_Delay[Region] =$   
 $Telephone\_Lines\_Deployment\_Delay[Region]+Payphone\_Devices\_Implement\_Delay$   
 $Payphone\_Devices\_Implement\_Delay = 1$   
 $Payphone\_Infrastructure\_per\_Users = 1$   
 $Payphone\_Infra\_Adjustment[VAS\_Infrastructure, Region] =$   
 $0+(Desired\_Payphone\_Infra[VAS\_Infrastructure, Region]-$   
 $Payphone\_Installed[VAS\_Infrastructure, Region]-$   
 $Payphone\_Deployment\_in\_Progress[VAS\_Infrastructure, Region])/Delay\_to\_Adjust\_$   
 $Payphone\_Infra[VAS\_Infrastructure, Region]$   
 $Payphone\_Infra\_Availability[Region] = Payphone\_Density[Payphones,$   
 $Region]/Payphone\_Availability\_Referential$   
 $Payphone\_Infra\_Discarded[VAS\_Infrastructure, Region] =$   
 $Payphone\_Infra\_Adjustment[VAS\_Infrastructure, Region]*Payphone\_Adjustment\_Discard\_Adequacy[VAS\_Infrastructure, Region]$   
 $Payphone\_Investment[VAS\_Infrastructure, Region] =$   
 $Payphone\_Total\_Investment*Regional\_Payphone\_Infra\_Investment\_Fr[Region]$   
 $Payphone\_Density[Payphones, Urban] =$   
 $(Payphone\_Installed[Payphones, Urban]/(Ref\_Payphone\_Users[Urban]*Payphone\_Infrastructure\_per\_Users))$   
 $Payphone\_Density[Payphones, Rural] =$   
 $(Payphone\_Installed[Payphones, Rural]/(Ref\_Payphone\_Users[Rural]*Payphone\_Infrastructure\_per\_Users))$   
 $Ref\_Payphone\_Users[Region] = Population[Region]*Ref\_Payphone\_Users\_per\_People$   
 $Ref\_Payphone\_Users\_per\_People = 1$   
 $Regional\_Payphone\_Infra\_Investment\_Fr[Urban] = Urban\_Inv\_VAS\_Fr$   
 $Regional\_Payphone\_Infra\_Investment\_Fr[Rural] = 1-Urban\_Inv\_VAS\_Fr$   
 $Supplied\_Payphone\_Infra[VAS\_Infrastructure, Region] =$   
 $(Payphone\_Investment[VAS\_Infrastructure, Region]/Cost\_of\_each\_Payphone[Region])$   
 $+Payphone\_Deployment\_in\_Progress[VAS\_Infrastructure, Region]+Payphone\_Installed[VAS\_Infrastructure, Region]$   
 $T\_Lines\_per\_Payphone = 1$   
 $Urban\_Inv\_VAS\_Fr = 0.965$   
 $VAS\_Offered[Virtual\_Telephony, Urban] = 0$

VAS\_Offered[Virtual\_Telephony,Rural] = 0  
 VAS\_Offered[Payphone,Urban] = 0  
 VAS\_Offered[Payphone,Rural] = 0  
 VAS\_Offered[Prepaid\_Phone,Urban] = 0  
 VAS\_Offered[Prepaid\_Phone,Rural] = 0  
 Payphone\_Adjustment\_Discard\_Adequacy[VAS\_Infrastructure,Region] =  
 GRAPH(Payphone\_Infra\_Adjustment[VAS\_Infrastructure,Region])  
 (-1.00, -1.00), (-0.9, -0.7), (-0.8, -0.475), (-0.7, -0.295), (-0.6, -0.175), (-0.5, -0.1), (-0.4,  
 -0.045), (-0.3, -0.025), (-0.2, -0.01), (-0.1, -0.005), (-1.39e-016, 0.00)  
 Payphone\_Discard\_Adequacy[VAS\_Infrastructure,Region] =  
 GRAPH(Payphone\_\_Installed[VAS\_Infrastructure,Region]/(Payphone\_Infra\_\_Discard  
 ed[VAS\_Infrastructure,Region]+1))  
 (0.00, 0.00), (0.4, 0.335), (0.8, 0.535), (1.20, 0.705), (1.60, 0.81), (2.00, 0.88), (2.40,  
 0.94), (2.80, 0.97), (3.20, 0.99), (3.60, 0.995), (4.00, 1.00)  
 Payphone\_Ordering\_Adequacy[VAS\_Infrastructure,Region] =  
 GRAPH(Payphone\_Infra\_Adjustment[VAS\_Infrastructure,Region])  
 (0.00, 0.00), (0.1, 0.275), (0.2, 0.5), (0.3, 0.66), (0.4, 0.78), (0.5, 0.865), (0.6, 0.92),  
 (0.7, 0.955), (0.8, 0.975), (0.9, 0.99), (1, 1.00)  
 Supplied\_Payphone\_Adequacy[VAS\_Infrastructure,Region] =  
 GRAPH((Supplied\_\_Payphone\_Infra[VAS\_Infrastructure,Region]/(Maximum\_Paypho  
 ne\_Infra[VAS\_Infrastructure,Region]+Min\_VAS\_\_Infra)))  
 (1.00, 0.00), (1.01, 0.255), (1.02, 0.47), (1.03, 0.62), (1.04, 0.745), (1.05, 0.835), (1.06,  
 0.91), (1.07, 0.96), (1.08, 0.99), (1.09, 1.00), (1.10, 1.00)

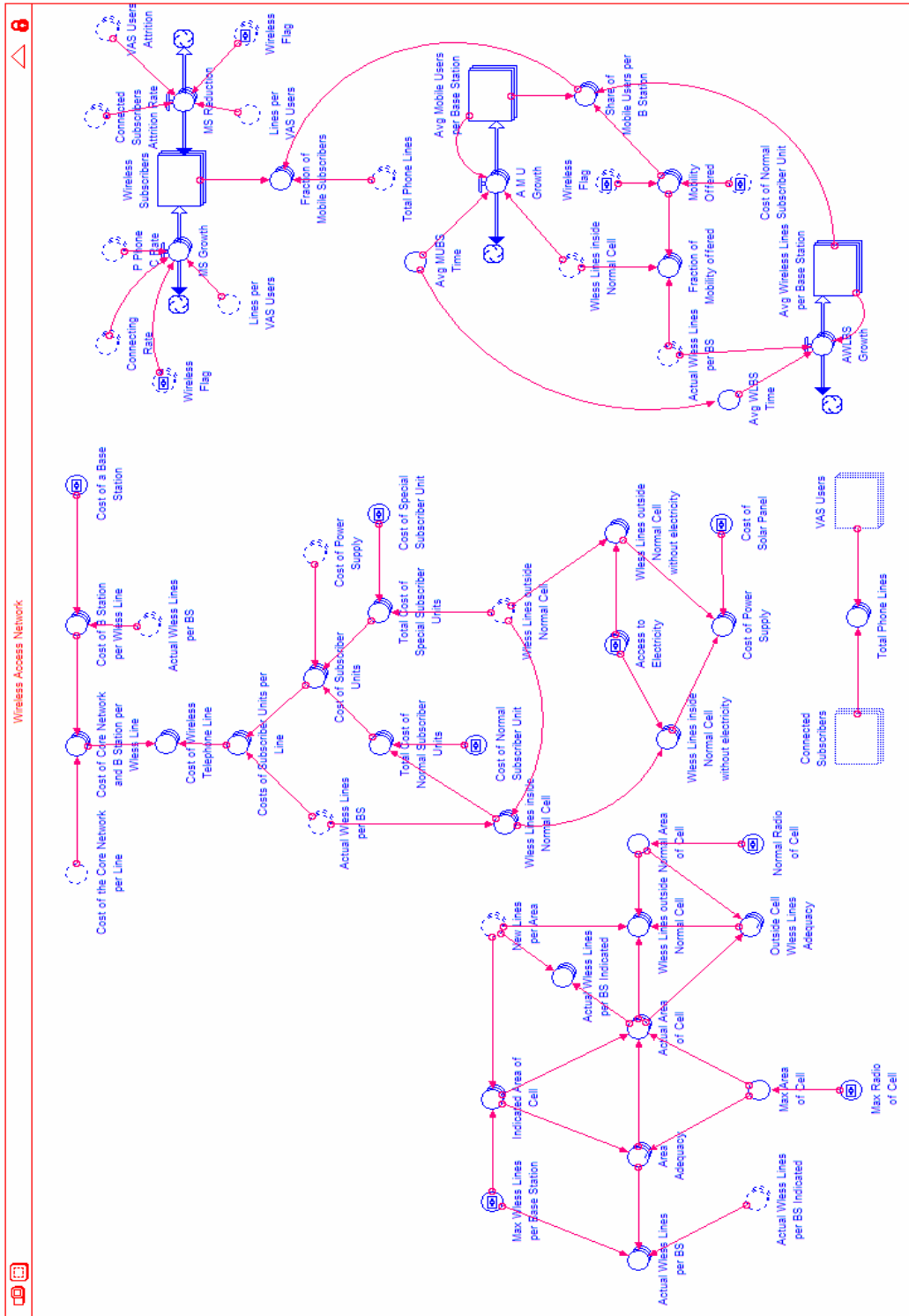
# WIRED ACCESS NETWORK EQUATIONS:



$Cost\_of\_External\_Plant\_per\_Line[Region] =$   
 $Referential\_Cost\_of\_External\_Plant+(Distance\_C\_Office\_Line\_Km[Region]*Meter\_Km\_Converter*Referential\_Cost\_per\_Meter\_of\_Cable)$   
 $Cost\_of\_the\_Core\_Network\_per\_Line = 40$   
 $Cost\_of\_Wired\_Network\_per\_Line[Region] =$   
 $Cost\_of\_External\_Plant\_per\_Line[Region]+Cost\_of\_the\_Core\_Network\_per\_Line$   
 $Coverage\_of\_Central\_Office[Region] =$   
 $Number\_of\_Lines\_per\_Central\_Office/New\_Lines\_per\_Area[Region]$   
 $Distance\_C\_Office\_Line\_Km[Region] =$   
 $SQRT(Coverage\_of\_Central\_Office[Region]/(2*3.1416))$   
 $Dist\_C\_Office\_Line\_Ratio[Region] =$   
 $Distance\_C\_Office\_Line\_Km[Region]/Ref\_Distance\_C\_Office\_Line\_Km[Region]$   
 $External\_Plant\_Deployment\_Time[Region] =$   
 $Ref\_Ext\_Plant\_Deployment\_Time[Region]*Dist\_C\_Office\_Line\_Ratio[Region]$   
 $Meter\_Km\_Converter = 1000$   
 $Network\_Telephone\_Density[Region] =$   
 $((Connected\_Subscribers[Region]+Prepaid\_Tel\_Lines[Region])*(1-$   
 $Wireless\_Flag[Region])/Population\_of\_Telephone\_Subscribers[Region])+(Wireless\_S$   
 $ubscribers[Region]*Wireless\_Flag[Region]/Population\_of\_Telephone\_Subscribers[Reg$   
 $ion])$   
 $New\_Lines\_per\_Area[Region] =$   
 $Normal\_Number\_of\_Lines\_per\_Area[Region]*Region\_Lines\_Density\_Adequacy[Regi$   
 $on]$   
 $Normal\_Number\_of\_Lines\_per\_Area[Region] =$   
 $Population\_Density[Region]/Number\_of\_people\_per\_line_[Region]$   
 $Number\_of\_Lines\_per\_Central\_Office = 5000$   
 $Number\_of\_people\_per\_line_[Region] =$   
 $Num\_of\_People\_per\_House[Region]/Num\_of\_Lines\_per\_House[Region]$   
 $Population\_Density[Urban] = 284$   
 $Population\_Density[Rural] = 19$   
 $Referential\_Cost\_of\_External\_Plant = 150$   
 $Referential\_Cost\_per\_Meter\_of\_Cable = 0.10$   
 $Ref\_Cov\_of\_Central\_Office[Region] =$   
 $Number\_of\_Lines\_per\_Central\_Office/Ref\_Lines\_per\_Area[Region]$   
 $Ref\_Distance\_C\_Office\_Line\_Km[Region] =$   
 $SQRT(Ref\_Cov\_of\_Central\_Office[Region]/(2*3.1416))$   
 $Ref\_Ext\_Plant\_Deployment\_Time[Region] = 12$   
 $Ref\_Lines\_per\_Area[Region] =$   
 $Ref\_Pop\_Density[Region]/Number\_of\_people\_per\_line_[Region]$   
 $Ref\_Pop\_Density[Urban] = 284$   
 $Ref\_Pop\_Density[Rural] = 284$   
 $Time\_to\_Couple\_External\_Plant\_with\_Switching\_Equipment = 1$

```
Time_to_Deploy_Telephone_Line[Region] =
IF(External_Plant__Deployment_Time[Region]>=Time_to_Install_Switching_Equipm
ent[Region])THEN(External_Plant__Deployment_Time[Region]+Time_to_Couple_Ext
ernal_Plant_with_Switching_Equipment)ELSE(Time_to_Install_Switching_Equipm
ent[Region]+Time_to_Couple_External_Plant_with_Switching_Equipment)
Time_to_Install_Switching_Equipment[Urban] = 8
Time_to_Install_Switching_Equipment[Rural] = 18
Region_Lines_Density_Adequacy[Region] =
GRAPH(Network_Telephone_Density[Region])
(0.00, 5.00), (0.1, 4.75), (0.2, 4.28), (0.3, 3.52), (0.4, 2.46), (0.5, 1.92), (0.6, 1.64), (0.7,
1.42), (0.8, 1.26), (0.9, 1.12), (1, 1.00)
```

# WIRELESS ACCESS NETWORK EQUATIONS:



$$\text{Avg\_Mobile\_Users\_per\_Base\_Station}[\text{Region}](t) = \text{Avg\_Mobile\_Users\_per\_Base\_Station}[\text{Region}](t - dt) + (\text{A\_M\_U\_Growth}[\text{Region}]) * dt$$

INIT Avg\_Mobile\_Users\_per\_Base\_Station[Region] =  
 Wless\_Lines\_inside\_Normal\_Cell[Region]\*Mobility\_Offered[Region]

INFLOWS:  

$$\text{A\_M\_U\_Growth}[\text{Region}] = (\text{Wless\_Lines\_inside\_Normal\_Cell}[\text{Region}] - \text{Avg\_Mobile\_Users\_per\_Base\_Station}[\text{Region}]) / \text{Avg\_MUBS\_Time}$$

$$\text{Avg\_Wireless\_Lines\_per\_Base\_Station}[\text{Region}](t) = \text{Avg\_Wireless\_Lines\_per\_Base\_Station}[\text{Region}](t - dt) + (\text{AWLBS\_Growth}[\text{Region}]) * dt$$

INIT Avg\_Wireless\_Lines\_per\_Base\_Station[Region] =  
 Actual\_Wless\_Lines\_per\_BS[Region]

INFLOWS:  

$$\text{AWLBS\_Growth}[\text{Region}] = (\text{Actual\_Wless\_Lines\_per\_BS}[\text{Region}] - \text{Avg\_Wireless\_Lines\_per\_Base\_Station}[\text{Region}]) / \text{Avg\_WLBS\_Time}$$

$$\text{Wireless\_Subscribers}[\text{Region}](t) = \text{Wireless\_Subscribers}[\text{Region}](t - dt) + (\text{MS\_Growth}[\text{Region}] - \text{MS\_Reduction}[\text{Region}]) * dt$$

INIT Wireless\_Subscribers[Region] = 0

INFLOWS:  

$$\text{MS\_Growth}[\text{Region}] = (\text{Connecting\_Rate}[\text{Region}] + \text{P\_Phone\_C\_Rate}[\text{Prepaid\_Phone, Region}] * \text{Lines\_per\_VAS\_Users}) * \text{Wireless\_Flag}[\text{Region}]$$

OUTFLOWS:  

$$\text{MS\_Reduction}[\text{Region}] = (\text{Connected\_Subscribers\_Attrition\_Rate}[\text{Region}] + \text{VAS\_Users\_Attrition}[\text{Prepaid\_Phone, Region}] * \text{Lines\_per\_VAS\_Users}) * \text{Wireless\_Flag}[\text{Region}]$$

Access\_to\_Electricity[Urban] = 0.98  
 Access\_to\_Electricity[Rural] = 0.5

$$\text{Actual\_Area\_of\_Cell}[\text{Region}] = (\text{Max\_Area\_of\_Cell} + \text{Area\_Adequacy}[\text{Region}] * (\text{Indicated\_Area\_of\_Cell}[\text{Region}] - \text{Max\_Area\_of\_Cell}))$$

$$\text{Actual\_Wless\_Lines\_per\_BS}[\text{Region}] = \text{Actual\_Wless\_Lines\_per\_BS\_Indicated}[\text{Region}] + \text{Area\_Adequacy}[\text{Region}] * (\text{Max\_Wireless\_Lines\_per\_Base\_Station} - \text{Actual\_Wless\_Lines\_per\_BS\_Indicated}[\text{Region}])$$

$$\text{Actual\_Wless\_Lines\_per\_BS\_Indicated}[\text{Region}] = \text{Actual\_Area\_of\_Cell}[\text{Region}] * \text{New\_Lines\_per\_Area}[\text{Region}]$$

Avg\_MUBS\_Time = 100  
 Avg\_WLBS\_Time = Avg\_MUBS\_Time

$$\text{Costs\_of\_Subscriber\_Units\_per\_Line}[\text{Region}] = \text{Cost\_of\_Subscriber\_Units}[\text{Region}] / \text{Actual\_Wless\_Lines\_per\_BS}[\text{Region}]$$

Cost\_of\_a\_Base\_Station = 150000  

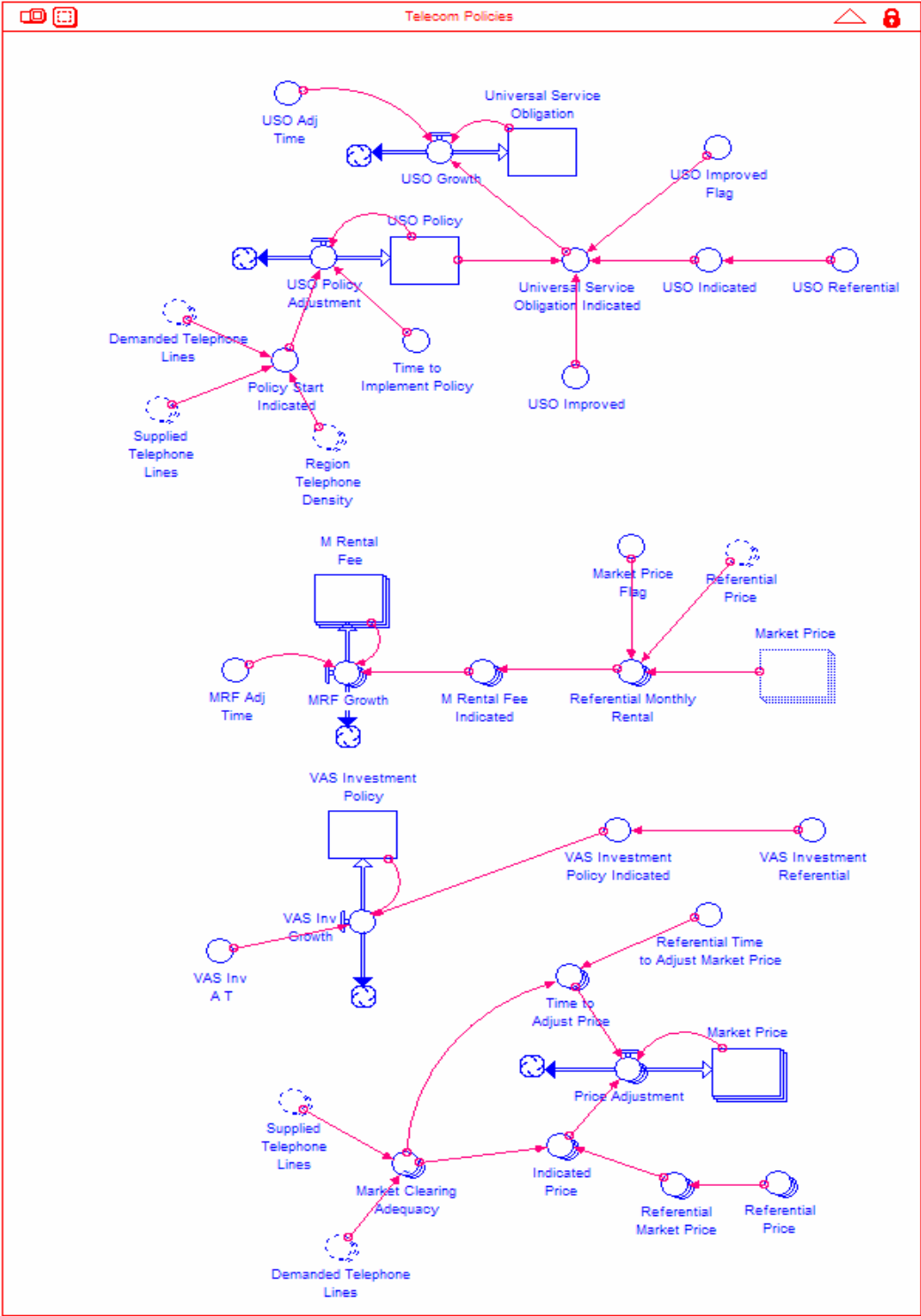
$$\text{Cost\_of\_B\_Station\_per\_Wless\_Line}[\text{Region}] = \text{Cost\_of\_a\_Base\_Station} / (\text{Actual\_Wless\_Lines\_per\_BS}[\text{Region}])$$

$Cost\_of\_Core\_Network\_and\_B\_Station\_per\_Wless\_Line[Region] =$   
 $Cost\_of\_B\_Station\_per\_Wless\_Line[Region]+Cost\_of\_the\_Core\_Network\_per\_Line$   
 $Cost\_of\_Normal\_Subscriber\_Unit = 50$   
 $Cost\_of\_Power\_Supply[Region] =$   
 $(Wless\_Lines\_inside\_Normal\_Cell\_without\_electricity[Region]+Wless\_Lines\_outside\_Normal\_Cell\_without\_electricity[Region])*Cost\_of\_Solar\_Panel$   
 $Cost\_of\_Special\_Subscriber\_Unit = 400$   
 $Cost\_of\_Subscriber\_Units[Region] =$   
 $Total\_Cost\_of\_Special\_Subscriber\_Units[Region]+Total\_Cost\_of\_Normal\_Subscriber\_Units[Region]+Cost\_of\_Power\_Supply[Region]$   
 $Cost\_of\_Wireless\_Telephone\_Line[Region] =$   
 $Cost\_of\_Core\_Network\_and\_B\_Station\_per\_Wless\_Line[Region]+Costs\_of\_Subscriber\_Units\_per\_Line[Region]$   
 $Cost\_of\_Solar\_Panel = 500$   
 $Fraction\_of\_Mobile\_Subscribers[Region] =$   
 $Wireless\_Subscribers[Region]*Share\_of\_Mobile\_Users\_per\_B\_Station[Region]/Total\_Phone\_Lines[Region]$   
 $Fraction\_of\_Mobility\_offered[Region] =$   
 $Wless\_Lines\_inside\_Normal\_Cell[Region]*Mobility\_Offered[Region]/Actual\_Wless\_Lines\_per\_BS[Region]$   
 $Indicated\_Area\_of\_Cell[Region] =$   
 $Max\_Wless\_Lines\_per\_Base\_Station/New\_Lines\_per\_Area[Region]$   
 $Max\_Area\_of\_Cell = (Max\_Radio\_of\_Cell^2)*3.1416$   
 $Max\_Radio\_of\_Cell = 30$   
 $Max\_Wless\_Lines\_per\_Base\_Station = 5000$   
 $Mobility\_Offered[Region] = IF(Cost\_of\_Normal\_Subscriber\_Unit < 100) THEN$   
 $(Wireless\_Flag[Region]*1) ELSE (0)$   
 $Normal\_Area\_of\_Cell = (Normal\_Radio\_of\_Cell^2)*3.1416$   
 $Normal\_Radio\_of\_Cell = 5$   
 $Share\_of\_Mobile\_Users\_per\_B\_Station[Region] =$   
 $Avg\_Mobile\_Users\_per\_Base\_Station[Region]*Mobility\_Offered[Region]/Avg\_Wireless\_Lines\_per\_Base\_Station[Region]$   
 $Total\_Cost\_of\_Special\_Subscriber\_Units[Region] =$   
 $Cost\_of\_Special\_Subscriber\_Unit*Wless\_Lines\_outside\_Normal\_Cell[Region]$   
 $Total\_Cost\_of\_Normal\_Subscriber\_Units[Region] =$   
 $Cost\_of\_Normal\_Subscriber\_Unit*Wless\_Lines\_inside\_Normal\_Cell[Region]$   
 $Total\_Phone\_Lines[Region] =$   
 $Connected\_Subscribers[Region]+VAS\_Users[Prepaid\_Phone,Region]+VAS\_Users[Virtual\_Telephony,Region]$   
 $Wless\_Lines\_inside\_Normal\_Cell[Region] = Actual\_Wless\_Lines\_per\_BS[Region]-$   
 $Wless\_Lines\_outside\_Normal\_Cell[Region]$   
 $Wless\_Lines\_inside\_Normal\_Cell\_without\_electricity[Region] =$   
 $Wless\_Lines\_inside\_Normal\_Cell[Region]*(1-Access\_to\_Electricity[Region])$



$Wless\_Lines\_outside\_Normal\_Cell[Region] =$   
 $New\_Lines\_per\_Area[Region]*((Actual\_Area\_of\_Cell[Region]-$   
 $Normal\_Area\_of\_Cell)*Outside\_Cell\_Wless\_Lines\_Adequacy[Region])$   
 $Wless\_Lines\_outside\_Normal\_Cell\_without\_electricity[Region] = (1-$   
 $Access\_to\_Electricity[Region])*Wless\_Lines\_outside\_Normal\_Cell[Region]$   
 $Area\_Adequacy[Region] =$   
 $GRAPH(Max\_Area\_of\_Cell/Indicated\_Area\_of\_Cell[Region])$   
 $(1.00, 0.00), (1.00, 0.215), (1.00, 0.425), (1.00, 0.615), (1.00, 0.74), (1.00, 0.84), (1.01,$   
 $0.91), (1.01, 0.96), (1.01, 0.985), (1.01, 1.00), (1.01, 1.00)$   
 $Outside\_Cell\_Wless\_Lines\_Adequacy[Region] =$   
 $GRAPH(Actual\_Area\_of\_Cell[Region]/Normal\_Area\_of\_Cell)$   
 $(1.00, 0.00), (1.00, 0.285), (1.01, 0.485), (1.01, 0.625), (1.02, 0.735), (1.02, 0.825),$   
 $(1.03, 0.885), (1.03, 0.935), (1.04, 0.975), (1.04, 0.995), (1.05, 1.00)$

# TELECOM POLICIES EQUATIONS:



Market\_Price[Region](t) = Market\_Price[Region](t - dt) + (Price\_Adjustment[Region]) \* dt

INIT Market\_Price[Region] = Referential\_Market\_Price[Region]

INFLOWS:

Price\_Adjustment[Region] = (Indicated\_Price[Region] - Market\_Price[Region]) / Time\_to\_\_Adjust\_Price[Region]

M\_Rental\_Fee[Region](t) = M\_Rental\_Fee[Region](t - dt) + (MRF\_Growth[Region]) \* dt

INIT M\_Rental\_Fee[Region] = M\_Rental\_Fee\_Indicated\_[Region]

INFLOWS:

MRF\_Growth[Region] = (M\_Rental\_Fee\_Indicated\_[Region] - M\_Rental\_Fee[Region]) / MRF\_Adj\_Time

Universal\_Service\_\_Obligation(t) = Universal\_Service\_\_Obligation(t - dt) + (USO\_Growth) \* dt

INIT Universal\_Service\_\_Obligation = USO\_Referential

INFLOWS:

USO\_Growth = (Universal\_Service\_Obligation\_Indicated - Universal\_Service\_\_Obligation) / USO\_Adj\_Time

USO\_Policy(t) = USO\_Policy(t - dt) + (USO\_Policy\_Adjustment) \* dt

INIT USO\_Policy = 0

INFLOWS:

USO\_Policy\_Adjustment = (Policy\_Start\_Indicated - USO\_Policy) / Time\_to\_\_Implement\_Policy

VAS\_Investment\_Policy(t) = VAS\_Investment\_Policy(t - dt) + (VAS\_Inv\_Growth) \* dt

INIT VAS\_Investment\_Policy = VAS\_Investment\_Policy\_Indicated

INFLOWS:

VAS\_Inv\_Growth = (VAS\_Investment\_Policy\_Indicated - VAS\_Investment\_Policy) / VAS\_Inv\_A\_T

Indicated\_Price[Region] =

Market\_Clearing\_Adequacy[Region] \* Referential\_Market\_Price[Region]

Market\_Price\_Flag = 0

MRF\_Adj\_Time = 3

M\_Rental\_Fee\_Indicated\_[Urban] = Referential\_Monthly\_\_Rental[Urban]

M\_Rental\_Fee\_Indicated\_[Rural] = Referential\_Monthly\_\_Rental[Rural]

Policy\_Start\_Indicated =

IF(Supplied\_\_Telephone\_Lines[Urban] >= Demanded\_Telephone\_\_Lines[Urban] AND Region\_Telephone\_Density[Urban] >= 0.01) THEN(1) ELSE(0)

Referential\_Market\_Price[Region] = Referential\_Price[Region]

Referential\_Monthly\_\_Rental[Urban] = Referential\_Price[Urban]\*(1-  
Market\_Price\_Flag)+Market\_Price[Urban]\*Market\_Price\_Flag  
Referential\_Monthly\_\_Rental[Rural] =  
Referential\_Price[Rural]+0\*Market\_Price[Rural]\*Market\_Price\_Flag  
Referential\_Price[Urban] = 1  
Referential\_Price[Rural] = 1  
Referential\_Time\_to\_Adjust\_Market\_Price = 60  
Time\_to\_\_Adjust\_Price[Region] =  
Referential\_Time\_to\_Adjust\_Market\_Price\*(1+Market\_Clearing\_Adequacy[Region])  
Time\_to\_\_Implement\_Policy = 12  
Universal\_Service\_Obligation\_Indicated = IF(USO\_Policy > 0.9 AND  
USO\_Improved\_Flag = 1)THEN(USO\_Improved)ELSE(USO\_Indicated)  
USO\_Adj\_Time = 3  
USO\_Improved = 0.45  
USO\_Improved\_Flag = 0  
USO\_Indicated = IF(TIME < 48) THEN (USO\_Referential+0.215\*0) ELSE  
(USO\_Referential)  
USO\_Referential = 0.035  
VAS\_Investment\_Policy\_Indicated = VAS\_Investment\_Referential  
VAS\_Investment\_Referential = 0  
VAS\_Inv\_A\_T = 30  
Market\_Clearing\_Adequacy[Region] =  
GRAPH(Supplied\_\_Telephone\_Lines[Region]/Demanded\_Telephone\_\_Lines[Region])  
(0.00, 10.0), (0.2, 7.35), (0.4, 5.20), (0.6, 3.55), (0.8, 2.25), (1.00, 1.00), (1.20, 0.45),  
(1.40, 0.1), (1.60, 0.1), (1.80, 0.05), (2.00, 0.005)