

# Worcester Polytechnic Institute



## **New Stormwater Management System Design for the EcoTarium Museum of Science and Nature in Worcester, MA**

A Major Qualifying Project  
Submitted to the Faculty of  
Worcester Polytechnic Institute

Written By  
Nicholas Cumello  
Zeke Feldman  
Benjamin Rickson  
Samantha Vogel

Advised By  
Paul Mathisen  
Harold Walker

Sponsored By



**4/7/2020**

# Table of Contents

Abstract.....	iii
Acknowledgements.....	iv
Executive Summary.....	v
Capstone Design.....	vi
Licensure.....	vii
1.0 Introduction.....	1
2.0 Background.....	2
2.1 Stormwater.....	2
2.2 Stormwater Contaminants.....	2
2.2.1 Heavy Metals.....	3
2.2.2 Nutrients.....	3
2.2.3 Total Solids.....	4
2.2.4 Pathogens.....	4
2.2.5 Anions.....	5
2.3 Stormwater Management.....	5
2.3.1 Stormwater Regulations.....	5
2.3.2 Best Management Practices.....	7
2.4 Past Work.....	8
2.5 EcoTarium.....	9
2.6 Summary.....	12
3.0 Methodology.....	13
3.1 Sampling.....	13
3.1.1 Field Testing.....	16
3.2 Laboratory Testing.....	17
3.3 Analysis.....	19
3.3.1 Software Analysis.....	20
3.4 Design.....	20
3.5 Deliverables.....	20
4.0 Results.....	22
4.1 Depth Probe Data.....	22
4.2 Downstream Flow.....	22
4.3 Lab Results.....	24
4.3.1 Pond Data.....	24
4.3.2 Parking Lot Data.....	26
4.3.3 Stream Data.....	28
4.3.4 Roof Data.....	30

5.0 Analysis .....	32
5.1 Site Mapping and Areas of Interest .....	32
5.2 Precipitation Data .....	34
5.3 Interpretation of Lab Data .....	35
5.4 BMP Analysis.....	39
6.0 Design .....	43
6.1 Concept Designs .....	43
6.1.1 Design Options for Upper Pond Area .....	43
6.1.2 Design Option for Lower Pond Area .....	49
6.2 Comparisons of Designs.....	53
6.3 Final Design of Options.....	54
6.3.1 Upper Lot Area .....	54
6.3.2 Lower Lot Area .....	55
7.0 Conclusion and Recommendations.....	58
References.....	59
Appendices.....	62
Appendix A: Table of various BMPs, descriptions and pollutant removal efficiencies.....	62
Appendix C: Sampling Procedure .....	71
Appendix D: Lab Data Sheet.....	73
Appendix E: pH Procedure.....	76
Appendix F: Total Phosphorus Procedure.....	77
Appendix G: Ammonia (NH <sub>3</sub> ) Procedure.....	79
Appendix H: ICS Anions Procedure .....	80
Appendix I: ICPMS Metal Test Procedure:.....	81
Appendix J: Bacteria procedure .....	82
Appendix K: TSS Procedure .....	83
Appendix L: Proposal.....	84
Appendix M: ArcMap Contour Map .....	123
Appendix N: List of Rain Garden Plants.....	124
Appendix O: Rain Garden Drawing .....	125
Appendix P: Oil/Grit Separator Drawing .....	126
Appendix Q: Infiltration Trench Drawing.....	128

## **Abstract**

This project quantified the contaminants in stormwater runoff flowing into two on-site ponds at the EcoTarium museum in Worcester, MA in order to design effective Best Management Practices (BMPs). Samples from various locations were collected and tested over multiple rain events. It was found that the contaminants of greatest concern in the stormwater runoff were total phosphorus and pathogens. BMPs for the EcoTarium were designed to primarily treat these contaminants with minimal site impact.

## **Acknowledgements**

Throughout our project we have received help from various individuals and groups. First off, we would like to thank our sponsor Nitsch Engineering and their representative, Coleman Horsley. Their guidance and the information they provided were instrumental in this project. We would also like to Worcester Polytechnic Institute's Civil and Environmental Engineering Department (CEE) for providing us with this opportunity, knowledge, and resources to complete this project. We would also like to give thanks to one of the CEE lab managers Wenwen Yao, who taught us lab procedures and helped us test and analyze water samples in the environmental lab. Next, we would like to thank the EcoTarium for their continuous support and access to their facility. Finally, we would like to thank our advisors, professors Paul Mathisen and Harold Walker, for their close guidance and feedback throughout the course of the project.

## **Executive Summary**

Stormwater has the capability of carrying various contaminants into water bodies and groundwater. The contaminants include metals, solids, and nutrients which all have various effects on water quality. With more urban development and impervious surfaces, the load of contaminants in stormwater increases. Because of the lack of infiltration and the more polluted nature of urban areas, the runoff contains higher concentrations of contaminants than non-urban stormwater. To help mitigate the effects of contaminated stormwater in urban areas Best Management Practices (BMPs) are used. BMPs have the capability to remove various contaminants. With knowledge about the contaminant loading in water bodies proper BMPs can be chosen to remove certain contaminants.

The goal of this project was to characterize the contaminants in stormwater runoff going into two on-site ponds at the EcoTarium Science Center so that effective BMPs could be designed. This project was sponsored by Nitsch Engineering, an engineering consulting firm. They were interested in the contaminant concentrations in different stormwater flows around the EcoTarium's campus. They were especially interested in the contaminant concentrations in the stormwater runoff coming off the roof. In addition to this, Nitsch was interested in the BMP design that this project recommends. Samples were collected at seven different sampling locations around the EcoTarium. Stormwater samples from five separate rain events were collected and brought to the lab for data analysis. This analysis consisted of determining the concentrations of total suspended solids (TSS), total phosphorus, ammonia, pH, total coliforms, E. coli and a variety of anions and metals in the samples. The concentrations in the stormwater samples were then compared to the New Jersey Surface Water Quality Standards due to the lack of consistent standards across Massachusetts. From laboratory testing, it was found that the contaminants with the highest concentrations were total phosphorus, total coliforms and E coli.

Based on the data collected from the HydroCAD model, flow concentrated at two locations. These two locations were where the BMP designs were focused. Five designs were suggested. Those designs were narrowed down to one per location based on their ability to remove contaminants, control flow, and aesthetic and educational value. The two designs chosen were an oil/grit separator paired with an infiltration trench between the lower parking lot and the stream and a vegetated filter strip and rain garden between the upper parking lot and upper pond. After narrowing down the designs to an oil/grit separator and infiltration trench in the lower parking lot and a vegetated strip and rain garden in the upper parking lot, cost and size analyses were conducted.

## Capstone Design

Our Major Qualifying Project (MQP) satisfies Worcester Polytechnic Institute's graduation requirement as well as the American Society of Civil Engineers' (ASCE) recommendation for an engineering design project. The requirements for this include the design of an open-ended project where the team defined the goals and criteria and for the design process to be iterative (ASCE, ABET, 2019). The design must also meet the standards set forth by local, state, and national legislative bodies. Additional criteria that our group considered were the environmental, sustainability, economic, and feasibility factors. The design for this project included all these criteria.

The project involved the design of a system to manage the contamination in the stormwater on the EcoTarium grounds. Our team designed a stormwater management system and based our design on the criteria of sustainability, environmental factors, economics, and the feasibility of the design to be used at the EcoTarium based on space, construction time, and maintenance.

- The sustainability for this project was important in the design of the system. The goal of the project was to filter out contamination in the stormwater runoff. If the system were to ineffectively remove the contaminants from the runoff, then design would have no purpose.
- The environmental factors were also important to account for. Keeping the environment as a priority is in line with the purpose and morals of the EcoTarium as a nature museum.
- The EcoTarium was given a grant to complete a water quality project. The financial limitations of this grant represents an economic limit to the cost of any design for their project. Accordingly, our project considered costs in the various stormwater control designs
- The EcoTarium wants to keep as much of its grounds untouched. The current developed land has been minimized to only what is needed to perform as a nature museum. This creates an area restriction that our group must follow.
- The time required for the system to be implemented should be limited as the environmental benefits cannot begin until the system is fully built.
- Our goal with the maintenance for the system was to not put a strain on budgets or labor for the EcoTarium. This means we wanted to design a system that would require the least amount of maintenance and when maintenance is required, it would be easy and cost-effective.

The design process for our project required multiple iterations of our design before a final design was settled on. While the stormwater runoff from the EcoTarium does not leave the site and therefore was not state regulated, our team used state codes for surface water contamination to determine the site needs for contaminant removal.

## **Licensure**

To protect the public, licensure is a practice for engineers to become certified that they are knowledgeable in their field (American Society of Civil Engineers, 2019). When licensed, a civil engineer takes on the moral and ethical responsibilities that come with the licensure. A professional engineer must be able to discern what the ethically and morally correct actions to take in a situation and act on those actions. Professional licensure is a means to ensure the safety of the public.

To obtain a license, an engineer must first complete their education at an ABET accredited engineering or engineering technology program. Then they must take and pass the fundamentals of engineering exam which can be taken during the senior year of an engineering program. Then after four years of experience, with some exceptions depending on the state, an applicant can fill out a detailed application with the work completed during those four years and references which shows the growth of the applicant in the professional field and boast to the merit of the applicant's character. At this point the applicant can then take the national Principles and Practice of Engineering exam and any state additions to the exam. Once passed the applicant will be licensed as a Professional Engineer in that state (American Society of Civil Engineers, 2019).



## 1.0 Introduction

Stormwater is water that originates from rain or snowmelt events and either flows into streams and other water bodies, evaporates, infiltrates into the soil, or is transpired by plants. In an urban setting, less of the water is able to infiltrate into the soil due to more impervious surfaces and instead is left to run into water bodies. Urban runoff contains higher concentrations of contaminants than non-urban stormwater due to lower rates of infiltration and higher contaminant concentrations (Environmental Protection Agency, 2019). As found by a previous WPI study, the surface that water flows over affects the contaminants and their concentrations that is found in the runoff (O’Leary, Stanway, Acaba, Balcewicz, and Adams, 2019).

Without proper treatment, stormwater carries contaminants into bodies of water. The polluted water can harm wildlife in the area. For example, studies of otters that were exposed to a contaminated river where stormwater was discharged found that the otters got bacterial infections due to fecal matter collected in the stormwater (Aguirre, Daszak, and Ostfeld, 2012; McBride, Conrad, and Smith, 2016). When runoff from agricultural land or lawns enters water ecosystems, the nutrients from that runoff cause eutrophication, where the ecosystem is suffocated by an excess of algae that grows because of the nutrients. To lessen the number of contaminants in runoff, BMPs are implemented. BMPs reduce the effect of stormwater runoff to either reduce flow and/or remove contaminants from the water.

The EcoTarium, a nature and science education museum in Worcester MA, is concerned about the contaminants collected by stormwater entering two ponds on their site. Contaminants such as solids, nutrients, or fecal matter can be picked up when stormwater runs through the animal exhibits, pathways, and parking lots. These contaminants can then be transported across the grounds and deposited into the ponds. The EcoTarium would like to improve their current stormwater management practices to better reduce the contaminants in the stormwater. There is a concern that the current stormwater management system is unable to fully remove these contaminants in the on-site stormwater runoff. This means that, in its current state, the EcoTarium cannot effectively treat the stormwater runoff going into its ponds.

The goal of this project is to quantify contaminants in the stormwater runoff on the EcoTarium campus and to make a preliminary design for an on-site stormwater management system. The EcoTarium has no legal obligations to treat its stormwater, because the on-site stormwater does not flow into the city’s infrastructure. Nevertheless, as a nature museum, the EcoTarium wants to keep their site clean of contamination as well as educate the public about stormwater management and its importance. Our project includes sampling and testing of the stormwater at the EcoTarium and data analysis to understand its impacts on the ponds. Then a design is tailored to the needs of the EcoTarium based on what contaminants are found in the sample.

## **2.0 Background**

The following sections will outline the background information needed for our report. Information about stormwater and common stormwater contaminants that are analyzed later in this study begin this section. State regulations for water quality and the methods for analyzing them follow. Finally, previous work related to the project and information about the location that this project is taking place, the EcoTarium, are discussed.

### **2.1 Stormwater**

Stormwater is any type of water that originates from a precipitation event. Precipitation events include rain, snow, or hail. The main landscapes that affect the stormwater in this study include undeveloped, urban, and agricultural areas. When stormwater accumulates on a natural surface it is more likely to infiltrate into the ground than in urban areas. In the natural system, water percolates through the soil. The plants and denser soils act as natural filters for the runoff, removing contaminants. Eventually the water infiltrates the ground and replenishes the water table. The rate at which soil can do this is called the soil's infiltration capacity. When rainwater lands on impervious surfaces, which includes roads, sidewalks, rooftops, and parking lots, the stormwater flows across them accumulating different pollutants and transporting them into nearby waterways. This pollution of stormwater is deemed non-point source pollution, which is when the runoff collects pollutants from many different sources that cannot be pinpointed to a given location. When stormwater accumulates on impervious surfaces, the pollutants and water are not able to infiltrate the ground and be naturally filtered by the soil and vegetation (Ho Lee, 2000).

Common pollutants found in stormwater include heavy metals, nutrients, bacteria, and total and dissolved solids. Many of these pollutants can cause environmental damage. These contaminants come from sources such as lawn fertilizer, automotive fluids, and litter. There are many ways to manage the stormwater as an effort to try and reduce contaminated runoff entering waterways. Different management practices such as stormwater detention basins, filters, and porous pavements can be uniquely beneficial to different areas to help mitigate contaminants from entering the water systems (Vassilios, 1997).

### **2.2 Stormwater Contaminants**

There are many different types of contaminants in stormwater that can be transported into bodies of water, where they can cause adverse environmental and health effects. This section outlines the types of contaminants commonly found in stormwater as well as their respective negative health and environmental impacts shown in Table 1.

**Table 1:** A list of different stormwater runoff contaminants, their sources, and impacts (Adamiec, Jarosz-Krzemińska, and Wieszala, 2016; Brooks Applied Labs, 2016; Environmental Protection Agency, 2019; Reddy, 2014; Reddy, 2014; Evanylo et al., 2008; Conley, 2009; Oram, 2019; Wu, Long, and Dorner, 2011; Minnesota Stormwater Manual, 2018; Swistock, 2015; Oram, 2019; New Hampshire Department of Environmental Services, 2008)

Contaminant	Sources	Impacts
Heavy Metals	- Roadways	- Inhibited gill functions of fish - Toxic to humans
Nutrients	- Fertilizer - Agricultural land	- Algae/Cytobacterium Blooms - Eutrophication
Total Solids	- Runoff - Soil Erosion	- Eutrophication - Increase in turbidity
Pathogens	- Fecal matter	- Health risk to animals that live in the water or use it as a drinking source
Ions	- Soluble salts	- Change in the pH of water - Toxic to aquatic life

### 2.2.1 Heavy Metals

Heavy metals are one of many different contaminants that contribute to stormwater pollution. Heavy metals of particular concern in stormwater are zinc, lead, copper, mercury, and nickel. Major sources of heavy metals in stormwater runoff include roads, construction-sites, and soil erosion. On roads, vehicle exhaust residue and brake pads have been identified as contributors to heavy metal contamination. (Adamiec, Jarosz-Krzemińska, and Wieszala, 2016). Heavy metal contamination of water bodies can lead to environmental impacts, such as copper inhibiting the respiratory system of fish or nickel and zinc severely damaging their gill functions (Brooks Applied Labs, 2016). Heavy metals are also highly toxic to humans; lead specifically has been found to put children at risk of major developmental problems (Environmental Protection Agency, 2019).

### 2.2.2 Nutrients

Nutrients such as nitrogen and phosphorus are necessary for plant life to grow. Nutrients in stormwater are not just atomic nitrogen or phosphorus, but instead are in the form of compounds such as phosphate, nitrite, and ammonia. These nutrients are often found in the runoff from lawns and agricultural land due to fertilizer use (Reddy, 2014). Fertilizer can negatively impact ponds or other water ecosystems that it enters due to stormwater runoff. When

exposed to high levels of nitrogen or phosphorus, water ecosystems may experience algae or cyanobacteria blooms (Figure 1), where the algae or cyanobacteria blooms to a point where they suffocate the ecosystem (Reddy, 2014; Evanylo et al., 2008; Conley, 2009). This process is called eutrophication. In eutrophication, when the bloom removes the other nutrients and blocks sunlight from the water other organisms in the ecosystem die. The dead organisms then release more nitrogen and phosphorus continuing the cycle.



**Figure 1:** An algae bloom in a small pond (“*Algae bloom in small farm pond*”, 2007).

### 2.2.3 Total Solids

Total solids include dissolved solids, suspended solids, and settleable solids in water. Solids are made up of both inorganic and organic material. Total dissolved solids (TDS) consist of calcium, chlorides, nitrate, phosphorus, iron and other ions that can pass through a filter with pores around two microns in size. Suspended solids (SS) are particles larger than two microns that stay suspended in water. Examples of these are soils, metals, clay, plankton, algae, and other debris which enter water systems from sources such as stream banks, construction-sites, and impervious pavements. There are many negative impacts on the water quality from having high concentrations of solids in the water systems which can affect the organisms living in the water. For example, suspended solids can serve as carriers of toxins, which cling to the particles and use the particles as a transportation mechanism. High concentrations of suspended solids will also lead to an increase in the turbidity of the water. A high turbidity affects water temperatures because suspended particles absorb and scatter sunlight. Sedimentation of these particles can also affect the habitats of bottom dwelling organisms (Environmental Protection Agency, 2019).

### 2.2.4 Pathogens

Pathogens are bacteria, viruses, and other microorganisms that can cause disease. There are many different pathogens making them expensive and inefficient to test for in water. Instead, determining the presence of other “indicator” microorganisms is more feasible (Oram, 2019; Wu, Long, and Dorner, 2011).

Bacteria can be found as a contaminant in stormwater runoff and mainly originate from animal waste. Bacteria is picked up from lawns and streets during rain events and carried into water bodies. Rooftops and parking lots are usually low contributors to bacteria concentrations. The presence of bacteria in water can indicate the possibility of fecal contamination. This is usually a concern because fecal matter in water is a health risk. In a study conducted in 2011, and enterococci have been linked to indicating fecal matter contamination (Minnesota Stormwater Manual, 2018). It is dangerous for humans to swim in water when it is present. Low concentrations of the bacteria in water can be present for humans to use recreationally. However, the presence of pathogens in the water make the water unsafe for animal consumption (Swistock, 2015). Coliform bacteria are a common indicator of the presence of pathogens in water. This bacterium originates from the intestinal tract of warm-blooded animals. The presence of this bacteria also indicates fecal contamination (Oram, 2019).

### **2.2.5 Anions**

Anions are negatively charged ions that can find their way into water bodies through stormwater runoff. Some examples of anions are chloride, sulfate, nitrite and phosphate. Anions can come from a variety of sources, such as fertilizers (nitrite, phosphate, sulfate) or from road salts (chloride, bromide) (Reddy, 2014). The effects of anions that come from fertilizers are summarized in the nutrients section (2.2.1). One of the main effects that road salt-based anions have on water is that they lower the pH of water bodies. This is a problem because certain organisms rely on a certain pH balance within water in order to survive and lowering the pH of the water can kill these organisms. Furthermore, some of these anions, such as chloride, are toxic to organisms (New Hampshire Department of Environmental Services, 2008). As different types of anions come from different sources, testing for a wide variety of them in a water body can give a good picture of what type of pollution the water body is facing.

## **2.3 Stormwater Management**

Stormwater management is an essential part of mitigating the negative effects of stormwater runoff and contaminants on the environment. Mismanagement of stormwater can lead to flooding, erosion, and water pollution (Adams, 2000). The application of stormwater management is very evident in many different land uses, including urban areas, agricultural drainage, flood control, water supply, and forest management. Standards for stormwater management are put into place by stormwater regulations, which establish a minimum level of treatment for stormwater. The water quality can be improved using BMPs to mitigate the contaminants that enter the waterways. The effective use of BMPs considers the quality and quantity of stormwater entering and leaving the system.

### **2.3.1 Stormwater Regulations**

In order to protect natural resources such as lakes, rivers, and coastal areas from potential damage, the Environmental Protection Agency (EPA) put the National Pollutant Discharge Elimination System (NPDES) into place in 1972. In order for any source to be able to legally discharge into a water body, a NPDES permit must first be obtained by the owner of the source. These permits address the problem of water pollution in two different ways. First, there are technology-based effluent limitations which require all water discharged from a site to undergo a

minimum amount of treatment. The other method of controlling water quality of discharge is Water Quality-Based Effluent Limitations (WQBELs), which establishes Total Maximum Daily Loads (TMDLs) for specific pollutants. These specify an amount of a pollutant or property of a pollutant that can be safely discharged into a water body and still ensure the quality of said water. The EPA sets minimum TMDLs for many different pollutants, but states can have more restrictive TMDL regulations (Environmental Protection Agency, 2019).

While the NPDES sets in place very specific regulations for any sites releasing pollutants as point source pollution, where pollution originates from a single source, it is much harder to regulate non-point source pollution, such as stormwater pollution. This is because non-point source pollution is not released from a site in a stream, instead being the collected contaminants picked up in water flow traveling through the site. Because of the difficulty in regulating stormwater pollution, the EPA only requires stormwater discharge permits from sites most at risk of causing stormwater pollution, such as construction-sites and industrial facilities. Stormwater runoff from municipalities and roads are also regulated, although the way in which they are regulated is different from regulations previously discussed. Stormwater pollution from these sources are regulated by Municipal Separate Storm Sewer Systems (MS4s), in which stormwater is collected and is eventually discharged into a local water body. Rather than these systems being owned directly by the EPA, they are owned by the town, city, or region that uses them. MS4s are required to be deployed alongside Stormwater Management Programs (SWMPs), which outline stormwater control practices that will be enacted by the MS4 community in order to minimize the amount of pollutants discharged from the MS4 system. It is important to stress that these systems solely handle stormwater, and that they are not part of a wastewater treatment system, such as a traditional sewer. (Environmental Protection Agency, 2019).

Massachusetts' major stormwater regulations are summarized in the Stormwater Management Standards section of the Massachusetts Stormwater Handbook, all of which are listed in Table 2. Simpler regulations, like that untreated stormwater cannot be discharged onto public land or that illicit discharges to the stormwater management system are prohibited, are stated outright in this section. More complex regulations, such as discharge to certain areas requiring different levels of treatment are outlined in this section with further details found later in the document. The one specific stormwater treatment requirement that always applies is that 80% of total suspended solids must be removed through treatment. (Massachusetts Department of Environmental Protection, 2008).

**Table 2:** Massachusetts Stormwater Management Standards (Massachusetts Department of Environmental Protection, 2008).

Number	Regulation
1	Untreated Stormwater may not be discharged directly or to cause erosion in wetlands/public bodies of water
2	Stormwater management systems may not have peak discharge that exceeds the pre-development peak discharge
3	Loss of annual recharge to groundwater must be eliminated through the design of the stormwater management system
4	Stormwater management systems shall be designed to remove 80% of Total Suspended Solids (TSS)
5	Land uses with higher potential pollutant loads must have source control and pollution prevention systems implemented in the stormwater management system.
6	Stormwater discharges within the Zone II or Interim Wellhead Protection Area of a public water supply, and stormwater discharges at/near any other critical are must have source control and pollution prevention systems implemented into the stormwater management system
7	Redevelopment projects are required to meet Stormwater Management Standards 2, 3, 4, 5, and 6 to the maximum extent practicable. Existing stormwater discharges must comply with Stormwater Management Standard 1 to the maximum extent practicable.
8	A plan to limit any construction related stormwater impacts (erosion, sedimentation, pollutant discharge) must be developed and implemented
9	A long-term operation/maintenance plan must be developed and implemented for any stormwater management system
10	All illicit discharges to stormwater management system are prohibited

### 2.3.2 Best Management Practices

Best Management Practices are measures taken to reduce the amount of pollution collected in stormwater runoff. Their goal is to prevent pollution in runoff from contaminating nearby bodies of water. There are three type-based categories of BMPs: point BMPs, linear BMPs, and area BMPs. Point BMPs focus on treating pollutants from runoff sources that have been concentrated at a single point, such as a discharge pipe. This practice captures water from upstream drainage at a specific location. Point BMPs are usually a combination of designs to manage flow and remove pollutants. Linear BMPs are ones that are narrow and lie adjacent to streams to filter for pollutants before they reach the water. They also help with nutrient uptake

and add an aesthetic value. Area BMPs are management practices that are large in size and take the place of impervious surfaces to lessen pollution input (Environmental Protection Agency, 2019). Examples of each category can be found in Table 3 below.

**Table 3:** List of type based BMPs and examples of each (Environmental Protection Agency, 2019).

Point BMP	Linear BMP	Area BMP
Constructed Wetland Infiltration Basin Bioretention Sand Filter (surface) Rain Barrel Cistern Wet Pond Dry Pond	Grassed Swale Infiltration Trench Vegetated Filter Strip Sand Filter (non-surface)	Green Roof Porous Pavement

Each BMP can remove different contaminants with different efficiencies. When creating a system, the removal efficiencies need to be taken into consideration. Details of various BMPs and their removal efficiencies are outlined in Appendix A.

## 2.4 Past Work

Nitsch Engineering has worked on a study with the University of Virginia to revamp the west side of the university’s stormwater system and implement BMPs. The project worked with both students and staff of the university. Nitsch implemented green BMPs such as wetlands and streambank restoration to filter and manage stormwater on the site. Three BMPs were implemented which were able to effectively filter the area’s stormwater instead of requiring different stormwater systems at different locations (Nitsch Engineering, 2019).

In the 2018-2019 academic year, Nitsch Engineering worked with WPI to sponsor an MQP team that ran tests on the stormwater on WPI’s campus to determine contaminants in the runoff of different surfaces. The MQP team tested runoff that flowed into Salisbury Pond. The team tested several different types of surfaces that runoff flowed over for contamination including:

- Parking Lot
- Light Road
- Heavy Road
- Walkway
- Green Roof
- Grey Roof
- Grassy Hill
- Salisbury Pond



The results of the MQP found that the different surface types were not contributing the same concentrations of contaminants. It was found that the walkway, light road, and grass area all had high levels of sodium and chloride contamination. The team also found that TSS concentrations were highest on the walkway and grassy hill while total phosphorus was highest on the heavy road and the grassy hill (O’leary, Stanway, Acaba, Balewicz, Adams, 2019). Furthermore, the team found that different surface types contribute different contaminants to stormwater. These results proved that the levels and types of contamination are dependent on the surface that the runoff flows over and that in designing BMPs, the surfaces that the runoff flows over must be accounted for in the design. The chosen design was a level spreader, swale, sediment forebay, and a rain garden. This design both decreased the peak flow from the campus into Salisbury Pond as well as removed contamination.

## **2.5 EcoTarium**

Nitsch Engineering is now working with WPI to sponsor our MQP team to sample stormwater at the EcoTarium. The EcoTarium is a nature and science museum located in Worcester, MA. The EcoTarium originally opened in 1825 under the name of the Worcester Lyceum of Natural History, changing names and locations over the years until 1998, when the museum was renamed to the EcoTarium. At the same time, the museum began an \$18 million expansion and renovation program, which has helped bring the EcoTarium to what it is today. Since its inception, the EcoTarium has been dedicated to instilling an interest in science and nature in its visitors. It does this through a variety of informational exhibits and activities both inside the EcoTarium as well as outside around the EcoTarium’s 45-acre campus, a map of which is shown in Figure 2. Areas of concern for this project are the two ponds (Figure 3), the stream (Figure 4), the parking lots (Figure 5), and the roadway leading into the EcoTarium (EcoTarium, 2019). The ponds are the upper and lower ponds, the lower pond being the larger of the two. The upper pond is also reported to flood during rainier seasons during which the water leaches into the nearby otter exhibit. In addition to these areas, a significant portion of the EcoTarium’s campus is a priority habitat (personal contact, Coleman Horsley, 2019). This is an area inhabited by protected organisms and requires specific permitting to build on. This has been considered while selecting and designing BMP layouts for this project.



**Figure 2:** EcoTarium Site Map (Worcester EcoTarium Map, 2015)



**Figure 3:** EcoTarium's Lower Pond





**Figure 4:** Stormwater stream bed at the EcoTarium



**Figure 5:** Storm drain at the EcoTarium

The EcoTarium is not required to have an on-site stormwater management system. This is because EPA regulations only require an on-site management system for construction-sites and industrial facilities, and the EcoTarium falls into neither of these categories. However, the EcoTarium currently has a stormwater management system, both a system of storm drains leading from the parking lots and a detention pond. However, this system does not meet their own standards for treatment. There are two major reasons that the EcoTarium tasked Nitsch Engineering to design a BMP system for their site. First, the EcoTarium is concerned with the water quality of its two on-site ponds. These ponds serve as the drainage point for both the stormwater runoff from the EcoTarium and for the surrounding area. This means that some stormwater control measures are necessary to maintain the water quality of these ponds. Second, the EcoTarium can use the stormwater control system as another exhibit for guests, educating them about stormwater pollution and how it is prevented and controlled.

## **2.6 Summary**

The EcoTarium wanted to know what contaminants were in their stormwater so they could design an additional stormwater management system accordingly. As proven by prior work, to test for contamination in the runoff at the EcoTarium, a more targeted approach to testing where we test specific areas to see the difference in their levels of contamination is necessary. This allows for more targeted BMPs to be implemented on the site.

### **3.0 Methodology**

Our project involved a collaboration with Nitsch Engineering, to analyze and test stormwater runoff and design a new stormwater management system at the EcoTarium in Worcester, Massachusetts. The stormwater runoff was analyzed for different contaminants at various locations before the water entered the two on-site ponds. The data collected through laboratory testing was used to design cost-effective BMP solutions for stormwater remediation. We achieved this goal through the following objectives:

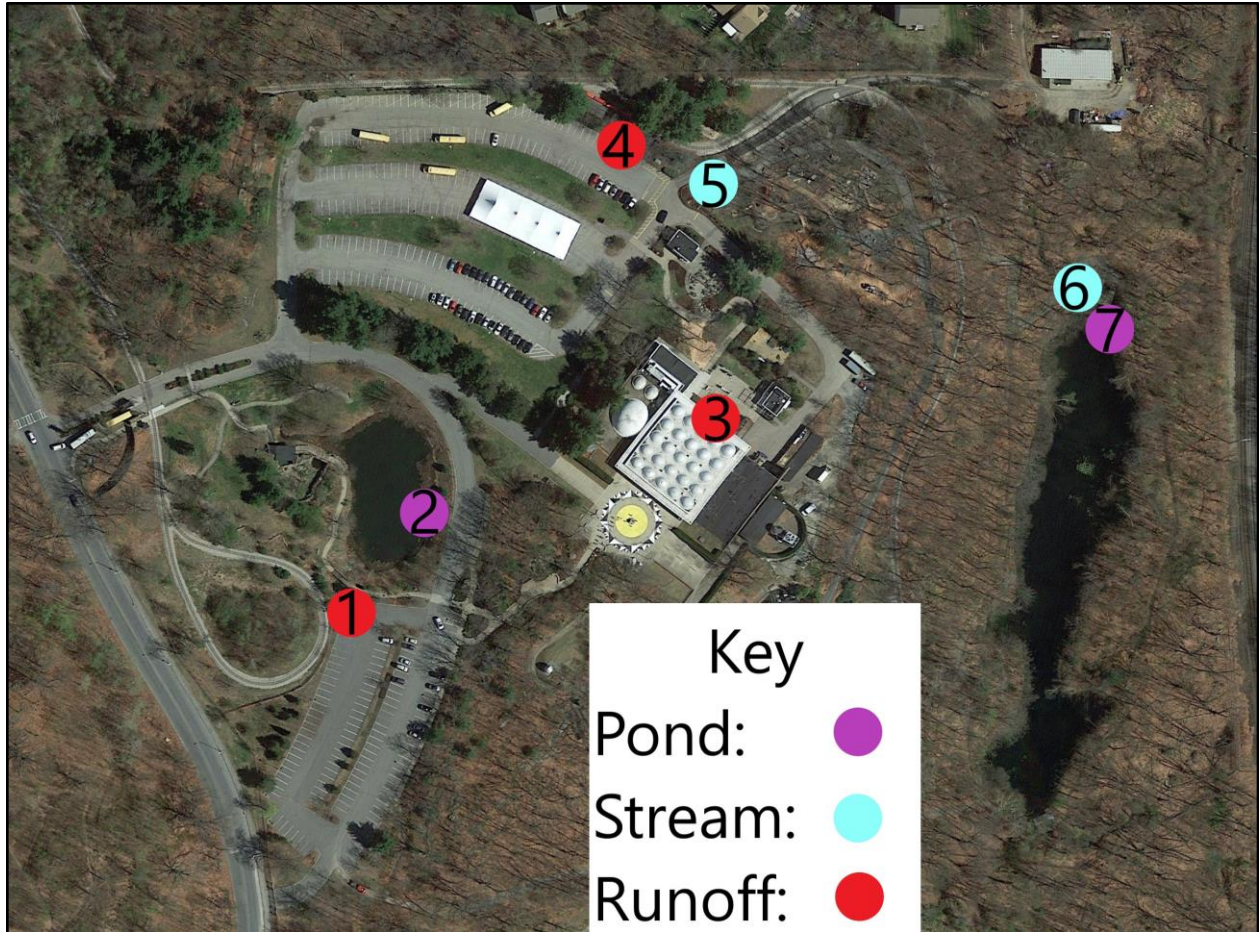
1. Collected and sampled water from the two on-site ponds and stormwater runoff from a range of land surface types multiple times during precipitation events.
2. Conducted laboratory analyses for various contaminants in the pond water and stormwater.
3. Analyzed the contaminant data in order to understand the impacts of surface characteristics on water quality.
4. Designed multiple stormwater solutions to reduce the concentrations of contaminants from the stormwater.

Through these objectives we analyzed the data collected to draw a conclusion and used the best BMPs to help mitigate the contaminants in the stormwater and ponds at the EcoTarium.

#### **3.1 Sampling**





To sample a range of surface types, samples were collected from seven locations at the site: the upper pond, the lower pond, the upper parking lot, the lower parking lot, the stream's inflow, the stream's outflow, and from the runoff off of the roof. The rain events sampled occurred on October 9th, October 11th, October 27th and November 22nd. The sampling locations can be seen in Figure 6. Dry weather samples were additionally taken at the outflow of each pond. The dry weather samples were taken on September 16th, 2019. The sampling protocols used were based on the EPA and Nitsch Engineering's sampling protocols (Appendix B) (Environmental Protection Agency, 2010; Coleman Horsley, personal communication, 2019). Before sampling events, the bottles were washed with deionized water (DI water) and left to dry in the lab. Bacteria sample bottles were sanitized using a Sterilmatic. Three samples were taken from each location, a 300 mL bottle for pH testing, a sterile 300 mL bottle for bacteria testing, and a 1 L bottle to test for TSS, ammonia, total phosphorus, metals, and anions. The stream inflow and the pond samples were taken by completely submerging the bottles in the water. The stream's outflow was taken at a point where the flow was concentrated and flowed into the sample bottles. The flow was measured at this point as well by timing how long it took to fill a 1 L sample bottle. The parking lot samples were collected by using a clean 300 mL bottle to transfer the water that could be collected in the bottle from the shallow flows found on the parking lots into the sample bottles. A sterile bottle was used as an intermediary bottle for the bacteria samples and collected the same way. The roof sample was taken by holding a clean tarp below the lip of the roof allowing the runoff to drip onto the tarp and flow into the sampling bottles. This information is summarized in Table 4.


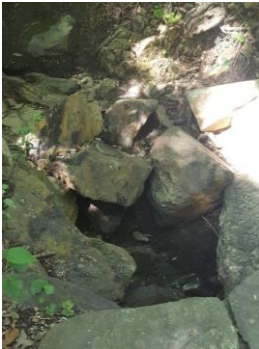





**Figure 6:** Sampling sites around the EcoTarium, purple dots for pond water collection-sites, light blue for stream collection-sites, and red dots for runoff collection-sites (Google Maps, 2019). The collection sites are (1) the upper parking lot, (2) the upper pond, (3) the roof, (4) the lower parking lot, (5) the stream, (6) the stream outflow, and (7) the lower pond.

**Table 4:** Sample locations and collection methods.

Location (Code)	Sample Collection Method	Purpose of sampling at the location	Photo
Upper Pond (UP1)	Holding the sample bottle under the water and letting the bottle fill completely.	To see the concentration of contaminants that had built up in the pond.	
Upper Parking Lot (UCL)	Using a clean 300 mL sample bottle to transfer any water that could be picked up at a time and transferring that water into a sample bottle and repeating until a sufficient amount of water was collected.	To measure the concentration of contaminants flowing into the upper pond.	
Lower Pond (LP1)	Holding the sample bottle under the water and letting the bottle fill completely.	To see the concentration of contaminants that had built up in the pond.	
Lower Parking Lot (LCL)	Using a clean 300 mL sample bottle to transfer any water that could be picked up at a time and transferring that water into a sample bottle and repeating until a sufficient amount of water was collected.	To test contamination concentrations before BMP implementation.	

Stream Inflow (STR)	Holding the sample bottle under the water and letting the bottle fill completely.	A measure of the concentration of contamination at a concentration point for the flow where there is a possibility of implementing a BMP.	
Stream Outflow (STRO)	Holding the bottle under a choke point in the stream to collect all the flow.	To measure the concentration of contaminants flowing into the lower pond and as a comparison to the stream inflow.	
Roof (ROOF)	Letting runoff drip onto a tarp that sloped into a collection bottle.	To compare the contamination in the runoff to the contamination at the rest of the site for research purposes.	

On-site, each bottle was rinsed three times in the sampling water before actual samples were taken to ensure proper quality assurance and quality control (QA/QC). The bottles were rinsed in a nearby location from where the final samples were taken in order to not disturb the sediment when dumping the water back into the site. The sampling procedures can be found in Appendix C.

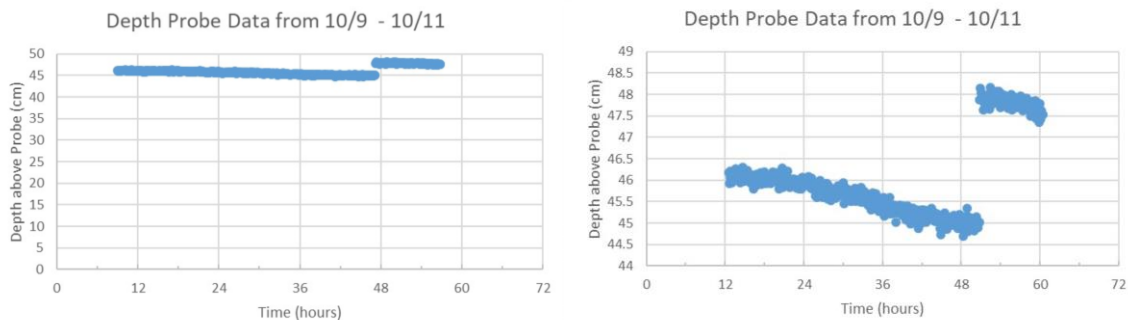
**3.1.1 Field Testing**

On-site temperature, dissolved oxygen (DO), and specific conductance testing was conducted using a YSI Model 85 probe. Before using the probe, our team did not calibrate it and thus the dissolved oxygen readings may be inaccurate. The probe was placed into the sample location and submerged as much as possible without disturbing the sediment. The readings were taken as a general average of the fluctuating reading given by the probe.

A depth probe was placed on-site before rain events to record change in depth of the water in ponds and streams. The probe used was the In-Situ Inc. Level TROLL 500 Data Logger. The probe was activated remotely on campus and was set to collect water level data every minute. This allowed our team to calculate total rainfall more accurately. The probe was left on-



site for a range of days. Collection time depended on when it rained and how often the test sites at the EcoTarium could be visited. To determine the change in water height during a rain event we used the depth probe to record the water level in the upper pond and the stream. We placed the probe in the upper pond for the first two rain events. After analyzing the data collected, it appeared the probe had been moved or tampered with. This could have been due to human interference, animal interference, and/or the probe shifting due to weather conditions. An example graph of the tampered depth probe data is in Figure 7 below. After discovering this, the depth probe was relocated to the stream for the remainder of the storm events. It was placed in the middle of the stream, not quite touching the bottom. We measured the distance from the streambed to the bottom of the probe after placing it to determine if there was any disturbance of the probe upon collection of the probe from the site.



**Figure 7:** Graphs of when depth probe was tampered with. The graph on the left is the raw data and the one on the right is it zoomed into the data cluster. At 48 hours, there is a clear jump in the depth above the probe.

To make this procedure more precise, we added a weir made from a wooden plank. An issue that we ran into using a wooden weir was that it did not fit the stream perfectly, so it allowed water to flow around it. The purpose of us using a weir was to determine the velocity of the flow of the water. Due to the weir failing we were unable to determine velocity this way. Moving the depth probe to the stream resulted in less noisy data, leading to cleaner graphs. The finalized graphs of the data are in Section 5.2.

### 3.2 Laboratory Testing

The collected samples were then tested in a lab. The lab tests performed and the contaminants that they test for are as follows:

- pH probe for pH
- Spectrophotometry for total phosphorus and ammonia
- Ion Chromatography Spectrometry (ICS) anions test for fluoride, chloride, nitrite, sulfate, bromide, nitrate, and phosphate
- Inductively Conducted Plasma Mass Spectrometry (ICPMS) metal test for manganese, copper, lead, sodium, magnesium, calcium, and iron
- A bacteria Quanti-Tray procedure to test for total coliforms and E. coli
- A TSS filtration test

In the lab, our group tested for pH, total phosphorus, anions, metals, ammonia, bacteria, and TSS. These parameters and contaminants were selected because they are contaminants of concern that are often treated using BMPs and they are also listed in the water quality standards

that we were referencing (see Section 2.2). The results of these laboratory tests can be found in Appendix D.

### *pH Testing*

The pH of a water system changes the types of aquatic life that can survive in the system. If the pH was to be changed too much from what it naturally is, then the aquatic life that the ecosystem supports would die out.

The pH was tested by using an Accumet AB150 pH probe. Before testing the samples, the probe needed to be standardized using buffer solutions. We used 4, 7, and 10 pH buffers to standardize the probe. pH buffers are solutions typically made of a weak acid and its conjugate base. These solutions provide a fixed pH reference, that can be used for calibrating a probe (lumen, 2020). The probe was standardized before each sample was tested to ensure QA/QC. It was placed into a sample bottle and after a few minutes the pH was recorded. After collecting the pH of a sample, the probe was standardized again with the buffer solutions. pH tests were conducted immediately after returning to the lab with samples to ensure more accurate pH readings.

### *Total Phosphorus and Ammonia*

Total phosphorus and ammonia concentrations should be regulated because too much of it in water can harm the aquatic ecosystem. Phosphorus and ammonia are important nutrients that support plant growth but too much can suffocate the organisms living in the water when it promotes algae blooms.

Total phosphorus and ammonia were analyzed using spectrophotometry. Spectrophotometry is a method of measuring how much light passes through a substance. It is used to determine the composition of a substance. Every substance absorbs light at different wavelengths (Vo, 2006). Total phosphorus samples had to be prepared by digesting unfiltered water samples, a sample of deionized (DI) water, and 6 standards with specific levels of phosphorus for calibration. Digestion is performed by adding nitric acid and sulfuric acid to a beaker of sample water, heating the samples on a hot plate until approximately 1 mL of the sample is left or the sample starts fuming, and then adding drops of hydrogen peroxide if the sample is cloudy or colored. After a day of digesting, DI water was added to the samples until the volume reached 25 mL. A drop of phenolphthalein indicator was added, and the samples were titrated with sodium hydroxide. A complete titration is indicated by the sample turning a slight purple hue. After titration, molybdovanadate was added. The samples were mixed thoroughly, and after a few minutes the spectrophotometer measured the sample.

25 mL of each filtered sample was used for ammonia testing. DI water and six standards were used to calibrate the spectrophotometer for ammonia measurements. The filtered water samples had drops of mineral stabilizer, Polyvinyl Alcohol Dispersing Agent (PADA) and molybdovanadate added to them before being mixed and left to sit for one minute before the spectrophotometer measured the sample.

### *Anion and Metals*

Anions include compounds such as nitrate and nitrite which, like other nitrogen compounds, are nutrients that can cause algae blooms. Metals are necessary in low concentrations but become toxic to organisms in higher doses.

Anion and metal analyses used ten mL of filtered water sample. For the ICS Anion test, standards of 100, 200, 400, 800, 1200, and 3000 ppb were made. For the ICPMS Metal test, 100

µL of concentrated nitric acid was added to each of the filtered samples. After this preparation for the tests was completed, the samples and standards were handed off to the lab manager to perform the rest of the ICS Anion and ICPMS Metal tests.

### *Bacteria*

Coliforms are bacteria that can originate from soil as naturally occurring bacteria. However, they are indicators of more harmful pathogens such as E. Coli, which comes from animal waste. Pathogens in the water can lead to disease in the wildlife that uses the water as a drinking source. As the EcoTarium has some wildlife roaming the grounds, having water that does not harm the local wildlife would be beneficial.

Bacteria testing was completed by adding one Colilert packet for total coliforms/E. coli to 100 mL of the sample and fully mixing. Then the sample was poured into a Quanti-Tray and the tray was tapped until all the air bubbles were removed from the sample. The Quanti-Tray was then sealed using the Quanti-Tray sealer machine and stored at 36 °C for 24 hours, after which the total coliform and E. coli concentrations were estimated based on the number of yellow boxes and the number of fluorescent boxes, respectively. The number of boxes counted of each size correlated to a table with the estimated total number of bacterial cells in a sample.

### *Total Suspended Solids*

TSS is the measure of how many non-dissolved solids exist in a system. Toxins and nutrients can often attach to solids in the water, thus the removal of solids in the water can lead to the removal of other toxins.

TSS measurements were taken by first measuring an amount of sample water. Then a filter of a measured weight was used to filter the water, leaving the suspended solids on the filter. The filter was then dried and weighed. After weighing, the filter was placed back into the oven for another hour to dry further before being weighed again to ensure that the measurement was a consistent, dry weight. If the weights were within 4% of each other, the average weight was used. If it was not within 4%, the sample would continue to be dried and weighed each hour until a consistent weight was found. The average sample weight and the sample volume were then used to determine the concentration of suspended solids in the sample.

More detailed test procedures are outlined in Appendices E-K. Each of the tests identified different contaminants in the collected samples. To ensure QA/QC, only one person conducted an entire experiment rather than multiple people working on the same procedure. This was done to attempt to minimize the variation of human error while collecting data. Multiple rain events were sampled to ensure that the data was accurate for the general trends and not an outlier due to problems in either testing or in sampling. The results from the lab analysis influenced which BMPs were suggested in the design portion of the project.

### **3.3 Analysis**

More detailed test procedures are outlined in Appendices E-K. Each of the tests identified different contaminants in the collected samples. The accuracies of the standards and analyses were determined to be consistent with the accuracies estimated for the laboratory procedures developed in WPI's laboratory, and they were also found to be consistent with stormwater results from previous projects. To ensure quality control, only one person conducted an entire experiment rather than multiple people working on the same procedure. This was done to attempt to minimize the variation of human error while collecting data. Multiple rain events were

sampled to ensure that the data was accurate for the general trends and not an outlier due to problems in either testing or in sampling. The results from the lab analysis provided a basis for determining the recommended BMPs in the design portion of the project.

### **3.3.1 Software Analysis**

The area usages and the soil types were found using the MassGIS data in WPI's storage drive and creating a model on ArcMap 10.7, along with the stormwater flow pathways that were identified using HydroCAD version 10.0. ArcMap is a software that creates maps, performs spatial analysis, manages geographical data and shares your results. The HydroCAD was used to obtain the peak flows and volumes of the different stormwater flows. HydroCAD is a computer aided design software used for modeling stormwater runoff. It also provides a range of commonly used hydrology and hydraulics capabilities including SCS, NRCS, and SBUH runoff hydrology, rational method, land use and analysis and contaminant load calculations and much more. A model was created to display the peak flow in both the lower pond and the upper pond subcatchment. The model was created to analyze the effects and routing of stormwater during various storm events. The rainfall data was collected through two means: a depth probe and a rain gauge at the Worcester Regional Airport, which can be found in Section 5.2. ArcMap and Google Earth were used to collect information on the area, soil types, soil slopes, and contours. This information was used to develop the HydroCAD model using the SCS Unit Hydrograph Method. Calculations of the total contaminant loading were done using the data from the contaminant concentrations and the peak flows found. Using the data from testing and analysis, we concluded which contaminants an implemented system will be treated for.

### **3.4 Design**

The final objective was to use the water quality and HydroCAD analyses and identify the areas in which BMPs can be implemented depending on where on-site stormwater contamination needed to be addressed and where stormwater flows were concentrated. We identified a set of stormwater management designs that could successfully treat the contaminants in the EcoTarium's stormwater. The different BMPs can be found in Appendix A. The table Appendix A shows the different BMPs and their abilities to remove the different contaminants. The BMPs were narrowed down based on their ability to filter the needed contaminants. The design considered the cost, the amount of land that would be needed, time needed for construction, the necessity for maintenance and upkeep, sustainability, and environmental aspects. Multiple BMPs were chosen that could treat the contaminants in the system. Five preliminary designs were created based off of these criteria and one system was chosen and designed based upon the criteria identified. The different designs were given as different options for the EcoTarium as to give the EcoTarium choices.

### **3.5 Deliverables**

The deliverables for this project included the proposal, the sampling data, and our final report that includes our final designs.

The first deliverable to the EcoTarium and Nitsch Engineering was our proposal, Appendix L. The proposal outlined our plan before we had begun the design phase of our project.

The sampling data table shows the collected data from our stormwater tests that were collected at the EcoTarium. This data shows where there is a concentration of different contaminants that are present in the site's stormwater. The data consists of the test done during

our five sampling events, one during dry weather and four during rain events. The data also shows the concentrations of contamination from the roof samples for Nitsch Engineering's use.

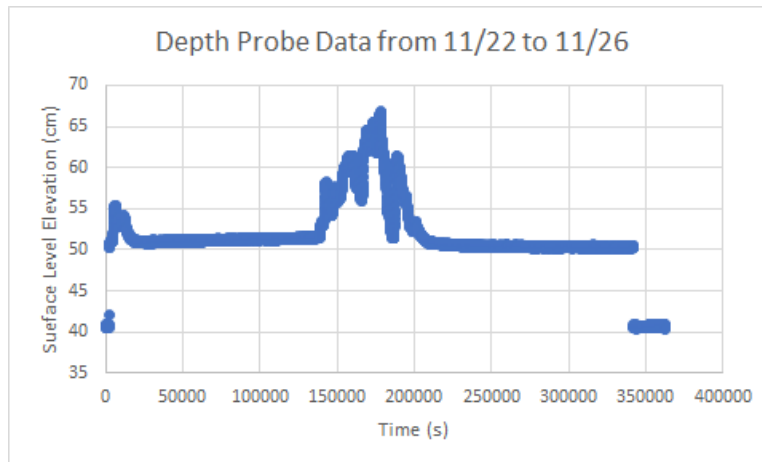
Our third deliverable is this report. This report shows the procedure and analysis that was followed to come to our conclusions and includes the data that we collected and the designs that we made. The designs present the data that shows their abilities to remove the targeted contaminants as well as their costs and required areas. Descriptions of the required maintenance, sustainability, as well as other benefits and detriments to the designs are presented with the designs. Two of the designs are further detailed by a cross sectional plan view.

## 4.0 Results

In this section we discuss the data results that we found using the depth probe, the flow data that was analyzed using HydroCAD, and the lab data results from our samples. These results are listed in Appendix D and will be explored further in the following section, 5.0 Analysis.

### 4.1 Depth Probe Data

The depth probe was intended to provide insight into the characteristics of the rainfall-runoff relationship at the site. The probe was set to collect water level data every minute. It was left on-site for days at a time during rain events. As seen in Figure 8, the removal and placement of the probe is indicated by the jumps in data points at the beginning and the end of the plot. The rise in elevation is a rain event that occurred on 11/24. Processing of the depth probe data can be found in Section 5.2.



**Figure 8:** Raw depth probe data from 11/22 to 11/26

### 4.2 Downstream Flow

In order to design a BMP system in each subcatchment, the stormwater runoff flow rates, volume, and the associated contaminants must be quantified to estimate the loads reaching the EcoTarium's upper and lower ponds. The contaminants are collected in the runoff as the stormwater flows through the subcatchment. Any BMPs are typically implemented in locations where they can effectively treat most of the contaminants in the runoff. This means that all of the contaminants coming from each catchment will be collected by a BMP system before the runoff can reach the ponds.

A limiting factor when designing a BMP system downstream is the stormwater flow rate entering the system. Since on this site most of the stormwater flows into a drainage system, the water is already concentrated into a single flow before it enters each pond. The subcatchments were modeled using HydroCAD. The HydroCAD model was used to simulate peak flows using the rainfall data collected from the depth probe and data from the Worcester Regional Airport's rain gauge. The airport's rain gauge data was used to verify the data collected from the depth probe. Tables 5 and 6 show the rainfall data and associated peak flows calculated at the end of each subcatchment. In Table 5 the rainfall data was collected from the National Oceanic

Atmospheric Administration (NOAA) Atlas. The data from Table 6 were collected from the Worcester Regional Airport’s rain gauge.

**Table 5: Peak Flows using the NOAA ATLAS Storm data**

Runoff Volumetric Flow Rates (cfs)					
Storm Intensity	1 Year (2.5 5 in)	2 Year (3.12 in)	10 year (4.84 in)	25 Year (5.92 in)	100 Year (7.57 in)
Runoff of Catchment 1 (Lower Pond)	6.94	10.36	21.08	26.44	31.03
Runoff of catchment 2 (Upper Pond)	4.5	6.42	12.21	16.1	19.89

**Table 6: Storm events from the Worcester rain gauge data showing the peak flows**

	Rain Event	Amount of precipitation (in)	Duration of Rain Event (hr)	Peak Flow (cfs)
Catchment 1	10/27	1.75	17	3.57
	10/30-10/31	1.35	37	1.99
	11/7	0.40	9	0.33
Catchment 2	10/27	1.75	17	2.56
	10/30-10/31	1.35	37	1.45
	11/7	0.40	9	0.29

Table 7 displays the peak flow rates of stormwater for subcatchments at the EcoTarium. The peak flows were calculated using HydroCAD and the rain events were from precipitation data collected by the team. This data will be beneficial when choosing a location for and in the design of the BMPs.

**Table 7:** Peak flows for subcatchments at the EcoTarium.

Rain Event	Amount of Precipitation (inches)	Duration (Hours)	Upper Parking Lot Peak Flow Rate (cfs)	Upper Stream Peak Flow Rate (cfs)	Lower Stream Peak Flow Rate (cfs)	Forested Hillside Peak Flow Rate (cfs)
10/27	1.75	17	1.45	3.41	2.88	0.70
10/30-10/31	1.35	37	0.79	2.47	2.05	0.15
11/7	0.40	9	0.23	0.42	0.32	-
2 Year Storm	3.12	24	1.89	5.08	4.73	4.85
10 Year Storm	4.84	24	2.95	7.79	7.38	11.21

### 4.3 Lab Results

Lab results were grouped together based on the locations that the samples came from. There were four groups: the ponds, parking lots, segments of the stream, and the roof. All of the bacteria test results were grouped below the rest of the test results to avoid confusion since the units were different. For all of the tables and graphs below, the highest measurement of each of the contaminants measured at each location was used.

#### 4.3.1 Pond Data

All stormwater runoff at the EcoTarium flows into the two on-site ponds. This means that the contaminants present in the pond give a good idea of the contaminants present in the stormwater runoff. There were a couple of interesting distinctions between the two ponds. The most notable difference is between the phosphorus concentrations. The lower pond phosphorus concentration is the second lowest of all locations sampled while the upper pond phosphorus concentration is seven times higher than the next highest location sampled (the stream inflow). However, the next highest measurement from the upper pond was fourteen times lower than the maximum, meaning that the reading is an outlier. Removing this outlier would leave the maximum concentration of the upper pond to only 0.298 mg/L. This still leaves the upper pond's total phosphorus concentration 1.5 times higher than the lower pond's concentration. Other notable differences were between the phosphate concentrations, where the lower pond value was ten times that of the upper pond. The lead concentration was five times higher in the upper pond. The arsenic concentration was twelve times higher in the upper pond. Lastly, the barium concentration was one hundred times higher in the upper pond. Both the upper and lower ponds had very high levels of total coliforms, with the upper pond having the maximum measurable concentration of total coliforms. The E. coli concentration in the lower pond was half of the total coliform's concentration. The E. coli concentration in the upper pond was less than 10% of the total coliform concentration. The data is summarized in Table 8.



**Table 8:** Average and Maximum Contaminant Concentrations for the Lower and Upper Ponds.  
Non-detected contaminants were labeled with ND.

Contaminants	Lower Pond Contaminant Concentration (mg/L)		Upper Pond Contaminant Concentration (mg/L)	
	Average	Maximum	Average	Maximum
Total Suspended Solids	15.1	38.0	18.9	26.2
Ammonia	0.167	0.181	0.0573	0.160
Total Phosphorus	0.0715	0.193	0.814	2.78
Fluoride	0.0510	0.0592	0.0501	0.0700
Chloride	82.0	88.0	79.2	95.9
Nitrite	ND	ND	ND	ND
Sulfate	12.6	13.6	15.3	16.5
Bromide	0.0531	0.0630	0.116	0.159
Nitrate	0.112	0.211	0.0494	0.102
Phosphate	0.0239	0.0554	0.00258	0.00598
Manganese	0.119	0.229	0.0625	0.0965
Copper	0.00283	0.00320	0.00320	0.00376
Lead	0.000284	0.00035	0.00132	0.00174
Sodium	42.4	45.93	42.1	52.5
Magnesium	2.00	2.07	0.494	0.720
Calcium	9.98	10.3	4.29	4.75
Iron	0.248	0.292	0.267	0.372
Chromium	0.000207	0.000207	0.000137	0.000137
Arsenic	0.000160	0.000160	0.00197	0.00197
Selenium	0.000109	0.000109	0.000533	0.000533
Silver	0.0000350	0.0000350	0.0000130	0.0000130
Cadmium	0.0000510	0.0000510	0.0000250	0.0000250
Barium	0.00359	0.000359	0.0315	0.0315
Total Coliforms (MPN/100mL)	685	913.9	934	1011.2
E. Coli (MPN/100mL)	200	456.9	30.2	75.9

### 4.3.2 Parking Lot Data

Stormwater runoff that flows into the EcoTarium ponds first flows over the parking lots. Because of this, it is important to know the concentrations of contaminants flowing off both the upper and lower parking lots. The nutrient concentrations in the parking lots were some of the highest nutrient concentrations compared to the other sampling locations. The parking lots were the only locations where nitrite was detected other than the roof, and both of the lots had much higher nitrite concentrations than the roof. One notable absence is that there was no lead detected in stormwater samples from the upper lot. While most of the contaminant concentrations are comparable across both lots, there were notable differences between the concentrations of fluoride, where the maximum concentration in the lower lot was nearly fifty times that of the upper lot, and chloride, where the maximum concentration was two and a half times higher in the upper lot. Despite this, both the lower and upper lots have very low chloride concentrations compared to the rest of the site. The highest total coliform concentrations found for both the lower and upper parking lots were the maximum measurable concentration of total coliforms. The lower lot's average total coliform concentration was equal to the maximum concentration while the upper pond's average total coliform concentration was 583 MPL/100 mL, The E. coli concentrations in the upper and lower parking lots were both less than 10% of the total coliform concentrations. This data is summarized in Table 9.

**Table 9:** Average and Maximum Contaminant concentrations for the Lower and Upper Parking Lots. Non-detected contaminants were labeled with ND.

Contaminants	Lower Lot Contaminant Concentration (mg/L)		Upper Lot Contaminant Concentration (mg/L)	
	Average	Maximum	Average	Maximum
Total Suspended Solids	15.3	17.3	21.4	31
Ammonia	0.360	0.442	0.301	0.500
Total Phosphorus	0.268	0.391	0.304	0.360
Fluoride	0.102	0.200	0.00117	0.00433
Chloride	1.169	1.76	2.57	4.33
Nitrite	0.193	0.258	0.111	0.121
Sulfate	0.722	0.821	1.08	1.51
Bromide	ND	ND	ND	ND
Nitrate	1.39	1.58	0.485	0.887
Phosphate	0.603	1.04	0.134	0.184
Manganese	0.0431	0.0678	0.0987	0.178
Copper	0.00257	0.00360	0.00138	0.00146
Lead	0.000276	0.000308	ND	ND
Sodium	1.07	1.42	1.04	1.68
Magnesium	0.148	0.193	0.165	0.232
Calcium	0.420	0.515	0.730	1.04
Iron	0.0275	0.0305	0.00582	0.00599
Chromium	0.0000391	0.0000391	0.000173	0.000173
Arsenic	0.0000646	0.0000646	0.000226	0.000226
Selenium	0.000236	0.000236	0.000215	0.000215
Silver	0.000230	0.000230	0.0000290	0.0000290
Cadmium	0.0000120	0.0000120	0.0000160	0.0000160
Barium	0.00507	0.00507	0.00473	0.00473
Total Coliforms (MPN/100mL)	1011.2	1011.2	583	1011.2
E. coli (MPN/100mL)	34.5	60.5	17.1	34.1

### 4.3.3 Stream Data

The stream flows from the lower parking lot to the lower pond and thus is an important location to know the concentrations of contaminants to know what contamination is entering the pond. The nutrient concentrations found in the stream were higher than the concentrations found in the ponds but lower than those coming from the lower parking lot. The concentrations of ammonia and nitrate increased from the inflow to the outflow of the stream while the concentration of total phosphorus and phosphate decreased. The concentrations of sodium, copper, magnesium and calcium increased along the stream, while the concentrations of manganese, lead and iron decreased down the stream. The concentrations of chromium, arsenic, selenium, silver, cadmium and barium were only tested for in the stream's outflow, therefore the change in concentration could not be determined. The stream inflow measured the maximum measurable concentration of total coliforms and E. coli each of the three times it was measured at that location. The first measurement of the bacteria samples at the outflow were higher than the second measurement. The average of the two samples still had a total coliform count above 800 MPN/100mL and an E. coli concentration above 500 MPN/100mL, both too high for safe use. This data is summarized in Table 10.

**Table 10:** Average and maximum contaminant Concentrations for the Stream Inflow and Outflow. Non-detected contaminants were labeled with ND. Contaminants that were not tested for are labeled with “-”.

Contaminants	Stream Inflow Contaminant Concentration (mg/L)		Stream Outflow Contaminant Concentration (mg/L)	
	Average	Maximum	Average	Maximum
Total Suspended Solids	15.2	38.5	8.60	13.4
Ammonia	0.146	0.377	0.245	0.490
Total Phosphorus	0.239	0.396	0.145	0.290
Fluoride	0.0419	0.0646	0.0639	0.0768
Chloride	57.9	105	172	186
Nitrite	ND	ND	ND	ND
Sulfate	8.43	14.7	24.4	25.6
Bromide	0.0233	0.0412	0.0766	0.0990
Nitrate	0.983	1.303144	1.07	1.18
Phosphate	0.0660	0.183	0.0485	0.0970
Manganese	0.194	0.300	0.0820	0.138
Copper	0.00170	0.00196	0.00233	0.00298
Lead	0.000219	0.000431	0.000152	0.000355
Sodium	32.1	57.4	86.2	90.4
Magnesium	1.10	1.84	3.16	3.30
Calcium	6.18	10.0	17.7	18.9
Iron	0.0853	0.129	0.0128	0.0226
Chromium	-	-	0.000108	0.000108
Arsenic	-	-	0.00167	0.00167
Selenium	-	-	0.000530	0.00053
Silver	-	-	0.0000180	0.0000180
Cadmium	-	-	0.0000450	0.0000450
Total Coliforms (MPN/100mL)	1011.2	1011.2	806	1011.2
E. Coli (MPN/100mL)	1011.2	1011.2	562	913.9

#### **4.3.4 Roof Data**

Only one stormwater sample from the roof was collected. Because of this, an average or maximum contaminant concentration cannot be determined. The roof data is important to Nitsch Engineering in their future work with the contamination of stormwater and the levels of phosphorus runoff. The roof sample had comparable concentrations of nitrate to the other locations. Nitrite was also detected in the roof samples. The concentrations were lower than those in the parking lots and was the only other location, besides the parking lots, for there to be any detection of nitrites. The total phosphorus concentration from the roof sample was below detectable levels. This was the only site without any detections of phosphorus, however there was a low concentration of phosphate detected. The only contaminants that were in the highest concentrations in the roof samples were chromium, arsenic, selenium, silver, and cadmium. Both the total coliform and concentrations in the roof sample were low. The roof sample was the only sample to have a total coliform measurement below 100 MPN/100mL, at 3 MPN/100mL. This data is summarized in Table 11.

**Table 11:** Contaminant concentrations found in roof samples. Non-detected contaminants are labeled with ND.

Contaminants	Roof Contaminant Concentration (mg/L)
Total Suspended Solids	6
Ammonia	0.106
Total Phosphorus	ND
Fluoride	0.00164
Chloride	0.575
Nitrite	0.0838
Sulfate	0.532
Bromide	ND
Nitrate	1.03
Phosphate	0.0449
Manganese	0.00195
Copper	0.00140
Lead	0.000032
Sodium	0.326
Magnesium	0.056
Calcium	1.11
Iron	0.00108
Chromium	0.00596
Arsenic	0.006
Selenium	0.00602
Silver	0.00601
Cadmium	0.00594
Barium	0.00594
Total Coliforms (MPN/100mL)	3
E. coli (MPN/100mL)	1

## 5.0 Analysis

To complete the third objective, analysis was conducted on the site and the data to achieve a better understanding of the on-site conditions such as stormwater contamination and flows. The analysis was used as a basis for the design to determine what contaminants need to be removed and which locations would BMPs be most successfully implemented. This section includes analyses of the site's land usage with respect to stormwater, the precipitation while we sampled, the interpretation of the lab data, and the BMPs and the reasoning on why certain ones were chosen over others.

### 5.1 Site Mapping and Areas of Interest

When analyzing the site and location around the EcoTarium there were many different characteristics to take into account when defining the land usages of the site. The surface types were divided into eight different types: parking lot/roadway, grassy area, forested hillside, walkway/patio, roof, sheer rock face, water body, and a mix of urban development and tree cover. In Figure 9 and Table 12 you can see the surface types locations and descriptions.



**Figure 9:** Map of the surface types around the EcoTarium. Each color is a different surface type. The color key can be found in Table 12.

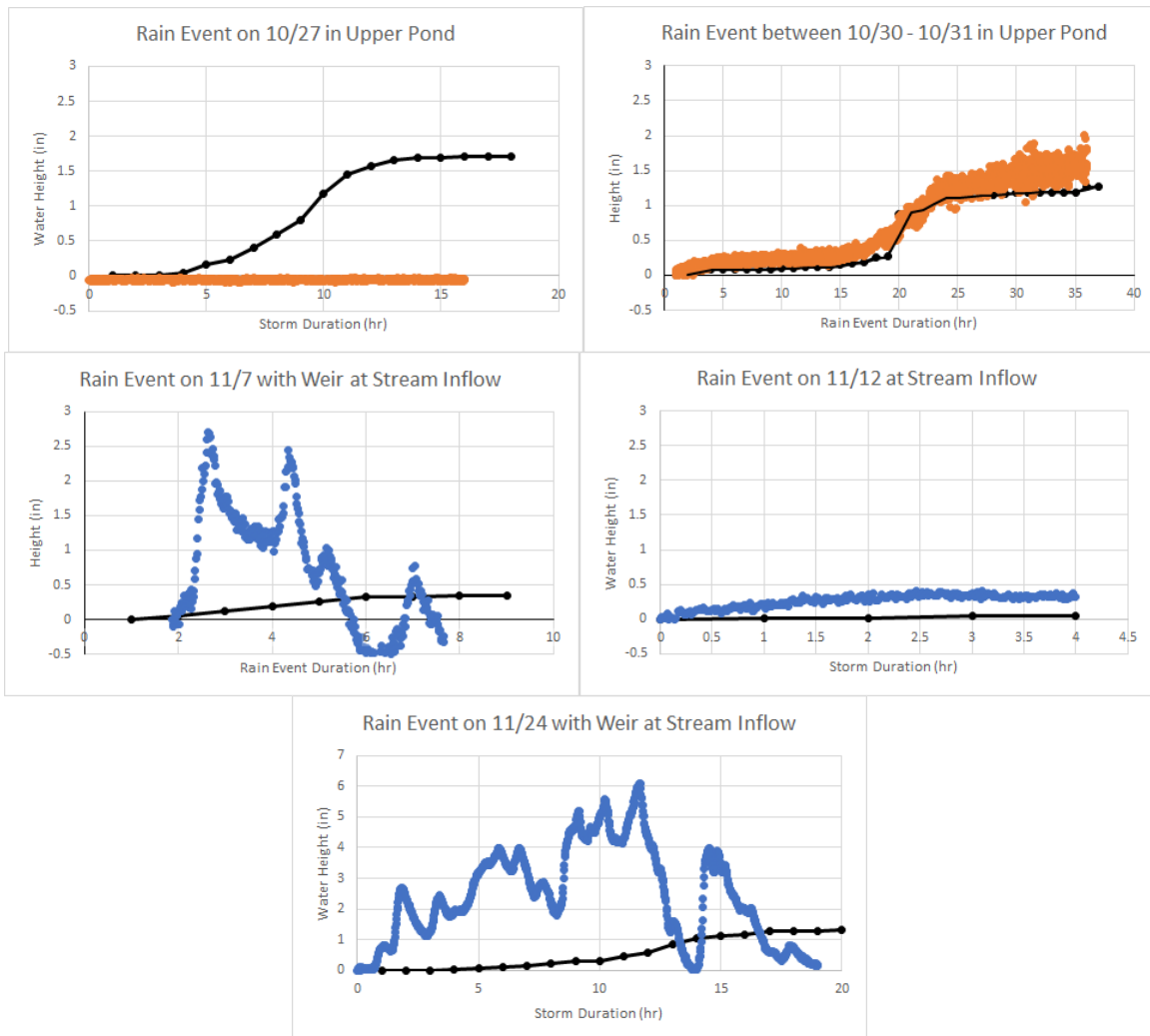


**Table 12:** A list of the surface types and descriptions shown above in Figure 9.

Surface Type	Description/Criteria	Locations (Color)	Area (ft <sup>2</sup> )
Parking lot/road ways	-Impervious paved area -Heavily used parking lots -Good surface flow	Red	181,849.52
Grassy Area	-Very pervious surface -Flat (no slope) -Free of tree and shrub coverage	Green	71,464.35
Forested Hillside	-Very pervious surface -Slope of 5-15% -Moderately dense with trees and shrubs -Poor flow	Purple	390,746.24
Walkways/patios	-Mostly impervious surface -Contains concrete pavers (impervious) -Decent flow	Yellow	127,259.42
Roof	-Impervious man-made structure -Flow accumulates and runs of roof surface	Light blue	13,979.46
Sheer Rock Face	-Nearly vertical slope -Very good flow down the face -Nearly impervious rock surface	Brown	43,835.22
Water Body	-Any surface covered by a pond	Dark Blue	64,726.30
Urban development and Tree coverage	-Has light tree and shrub coverage -Mainly grassy area -Has light man-made structure cover	Pink	395,550.05

## 5.2 Precipitation Data

To utilize the depth probe data the raw data needed to be manipulated. The first alteration made was the conversion of the units from centimeters to inches, and the time was changed from seconds to hours. The depth probe graphs were compared to raw precipitation data from a more official source, the Worcester Regional Airport rain gauge. The raw precipitation data was collected from Worcester Regional Airport's rain gauge for the duration of when the depth probe was placed on-site. This data was narrowed down to when a rain event occurred. After determining the time and date of the storm, the depth probe was zeroed using that time. This was useful in determining the change in water level during individual storms. The rain gauge data allowed us to determine the total rainfall during a rain event. This was overlaid with the depth probe data. The distance between the EcoTarium and Worcester's Airport is over five miles apart (Google Earth, 2020). This distance between the sites was determined to be minor enough that the precipitation at the separate locations would not vary significantly. The relation between the precipitation data and the height of the water shows how much runoff runs directly to the location compared to how much infiltrates. The final graphs are displayed in Figure 10.



**Figure 10:** A comparison of the cumulative inches of rainfall (black) for the rain event on the given date compared to the change in height of the water in inches (orange/blue). The orange is when the depth probe was placed into the upper pond and the blue is when it was placed in the beginning of the stream.

### 5.3 Interpretation of Lab Data

To analyze our lab results, the New Jersey Surface Water Quality Standards were compared to the lab data to determine how the EcoTarium’s water quality compared to their standards. The New Jersey standards were used instead of Massachusetts’ because they have specified TMDLs for individual ponds/lakes/rivers instead of a general set of limits. The MassDEP’s goal with their TMDL strategy is to reduce the amount of pollutants that reach prioritized bodies of water using BMPs. Due to the two ponds on the EcoTarium site being small and local ponds, there are no set TMDLs for them. New Jersey on the other hand has general and specific TMDLs. New Jersey also has the most rigorous surface water quality standards on the east coast (Coleman Horsley, personal communication, 2020). Below in Table 13 is the list of the general TMDLs that we used as guides when determining what contaminants needed to be reduced by the BMPs (Mass.gov, 2020; NJ.gov, 2019).

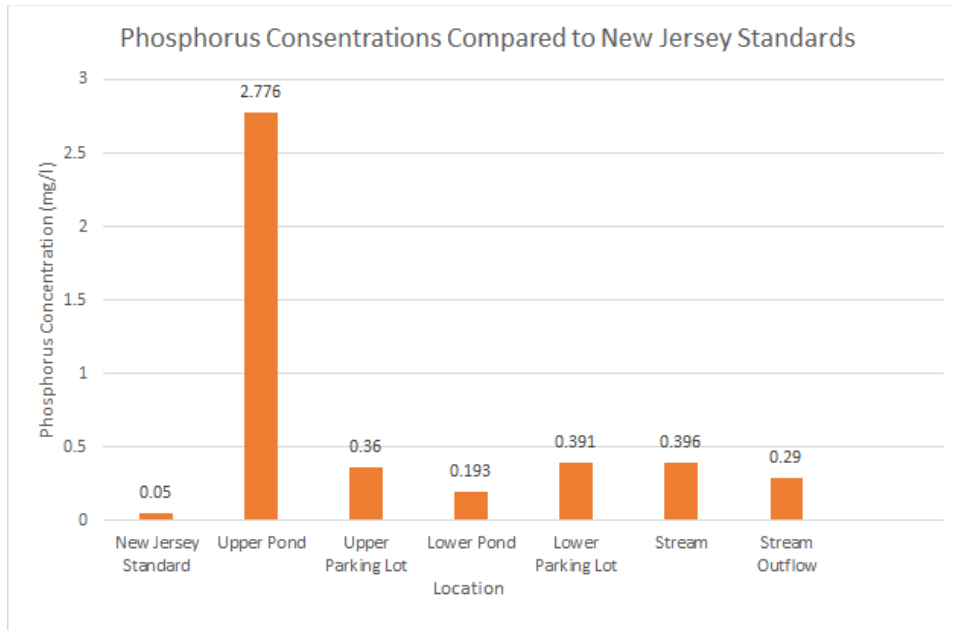
**Table 13:** List of New Jersey Surface Water Quality Standards used to analyze lab results (NJ.gov, 2019).

<b>Contaminant</b>	<b>New Jersey Standards for FW2 NT Waters</b>
E. coli	< 235/100 mL single sample or < 126/100 mL geometric mean
Fecal Coliforms	200/100 mL geometric average
Dissolved Oxygen	< 4.0 mg/L min at any time and < 5.0 24 hours
pH	6.5-8.5
Total Suspended Solids	< 40 mg/L
Phosphorus	0.05 mg/L
Nitrogen	2 mg/L

### 5.3.1 Ponds, Stream, and Parking Lots

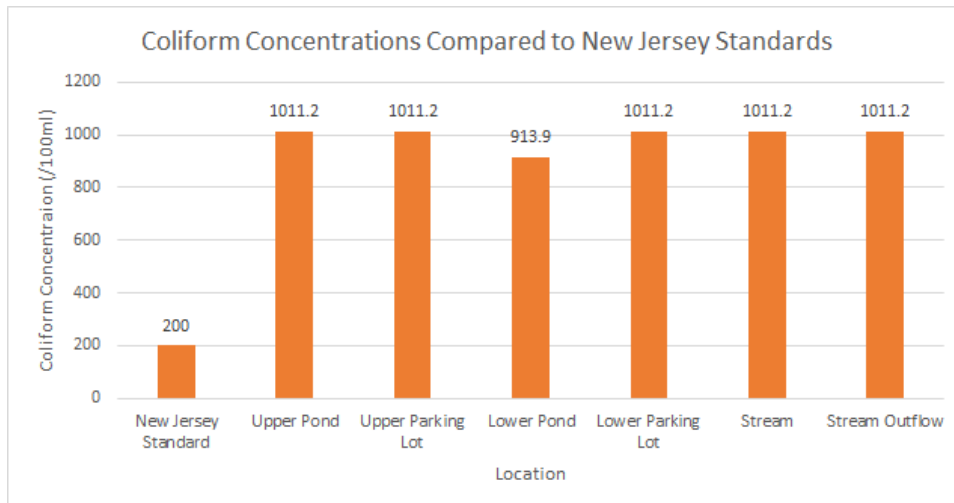
The lab data from the EcoTarium’s ponds, stream, and parking lots are grouped together because the data from all of them represents the same issues. The pollutants of most concern from these areas are total phosphorus and bacteria (both total coliforms and E. coli). The concentrations of these contaminants are well over the acceptable limits in the New Jersey surface water quality standards. All the other contaminants on the New Jersey Standards list that were tested for were well below the concentration limits outlined in the New Jersey Standards. These results mean that phosphorus and pathogen removal are the primary focus of BMP design for the EcoTarium.

The phosphorus concentrations for each sample location were higher than the New Jersey standards. A graph comparing the highest measured concentration at each location can be found in Figure 11. The Upper Pond’s maximum reading was an outlier. The second highest reading was 0.109 mg/L. This reading would make it the lowest of the sample locations. However, this sample is still two times higher than the New Jersey Standard.

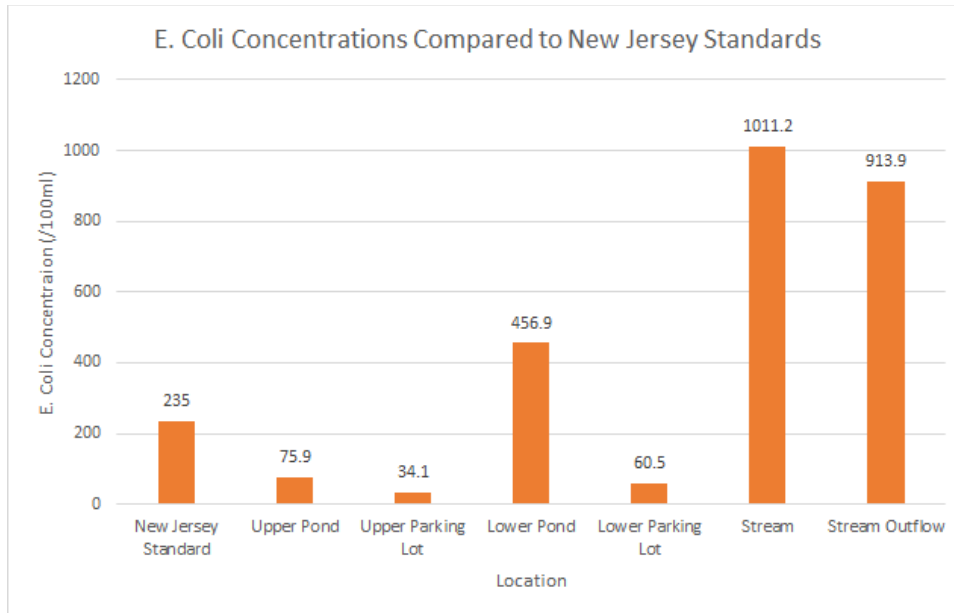


**Figure 11:** A comparison of the highest measured concentration of phosphorus at each sample site compared to the New Jersey Surface Water Standard.

The lowest case of the number of total coliforms per 100 mL for a sample was 4.5 times higher than the New Jersey Standard. Only three of the six sites sampled had *E. coli* concentrations above the New Jersey Standard. However, the *E. coli* samples that were above the Standard were nearly double the New Jersey standard at a minimum, and nearly five times the Standard at a maximum. The comparison of coliform concentrations to the New Jersey Standard can be found in Figure 12, and the comparison of concentrations can be found in Figure 13.



**Figure 12:** A comparison of the highest measured concentration of coliform at each sample site compared to the New Jersey Surface Water Standard.



**Figure 13:** A comparison of the highest measured concentration of each sample site compared to the New Jersey Surface Water Standard.

### 5.3.2 Roof

The lab data from the roof differs greatly from the rest of the lab data from the EcoTarium. There was no measurable concentration of phosphorus in the roof samples. There was a detectable level of ammonia, but it was below the concentrations found at the other sampling locations. Nitrate and nitrite were also measured in the roof samples, nitrate being in a higher or comparable concentration when compared with the other sampling locations. This gave the roof a total nitrogen concentration comparable to the other site locations. Stormwater samples from the roof measured the highest in concentrations of chromium, arsenic, selenium, silver, and cadmium compared to the other sampling locations. As there are no standards for metals in the New Jersey Surface Water Standards, the roof runoff complies with all of the standards. A comparison of the Roof contaminant concentrations to the New Jersey Surface Water Quality Standards can be found in Table 14.

**Table 14:** A comparison between the New Jersey Surface Water Quality Standards and the Roof Contaminant Concentrations. Contaminants that were below detection level were labeled “ND”, and contaminants that were not tested for were labeled “-”

Contaminants	New Jersey Standards for FW2 NT Waters	Roof Contaminant Concentrations
E. coli	< 235/100 mL single sample or < 126/100 mL geometric mean	1/100 mL
Fecal Coliforms	200/100 mL geometric average	-
Dissolved Oxygen	< 4.0 mg/L min at any time and < 5.0 24 hours	-
pH	6.5-8.5	7.24
TSS	< 40 mg/L	6 mg/L
Phosphorus	0.05 mg/L	ND
Nitrogen	2 mg/L	0.737 mg/L

#### 5.4 BMP Analysis

Before preparing our five design options, our group went through the Massachusetts Stormwater Handbook (Massachusetts Department of Environmental Protection, 2008). While reading, our group listed out the pros and cons of each of the BMPs to analyze which would work best for the EcoTarium. After compiling a list of possible BMPs, we went through it again. This time, BMPs that were less beneficial to the EcoTarium site were removed from the list. The BMPs that were considered to have a potential benefit to the EcoTarium were color coded to scale their perceived level of benefit. The factors that were considered when judging BMPs included: land area, cost, the contaminants being designed for, and the environmental aesthetic of the EcoTarium.

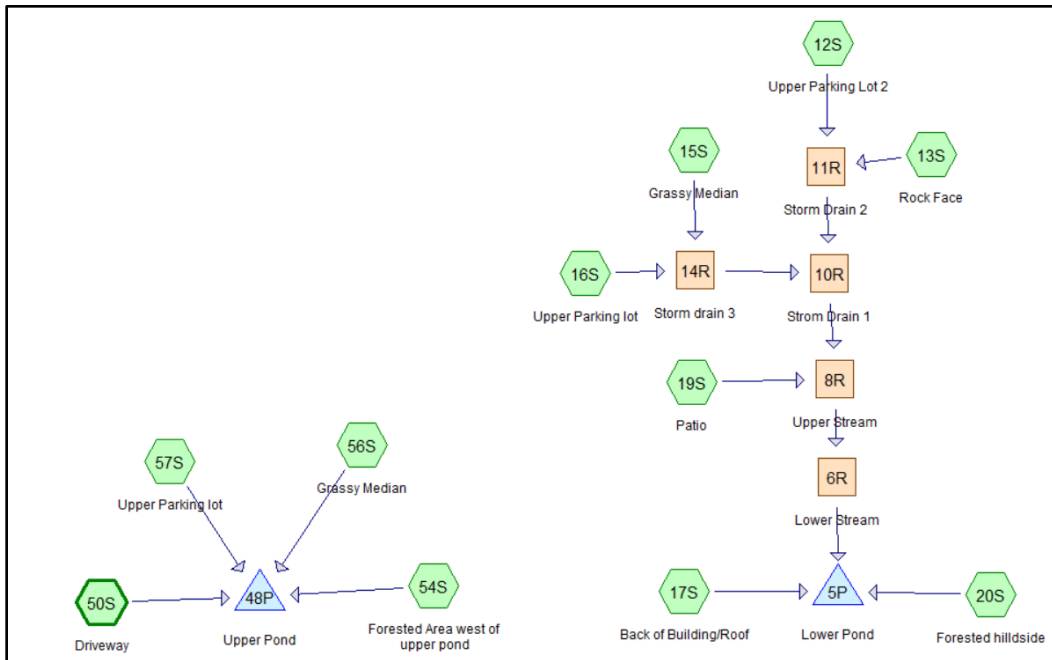
The locations of the BMPs were chosen for being concentration points for the water flow into the ponds. The HydroCAD model also displays multiple subcatchments that flow into the respective ponds and the concentration points. The topography, found in Appendix M, was analyzed and was used to divide the EcoTarium into two sections. The sections were separated based on the direction where rain would fall and flow. Figure 14 shows the areas of the two catchments.



**Figure 14:** The subcatchments around the EcoTarium Ponds. The smaller yellow section contains the flow from the upper parking lot into the upper pond. The larger yellow section contains the lower parking lot and the stream. They both flow into the lower pond. The black line shows the perimeter of the EcoTarium.

HydroCAD is a Computer Aided Design tool used by civil engineers for modeling stormwater runoff. HydroCAD provides a wide range of commonly used hydrology and hydraulics capabilities. Some of the capabilities include easy management and reporting of multiple rainfall events, hydrograph routing through ponds and reaches, and automatic pond storage calculations, including embedded storage chambers. A model was created to display the peak flow in both the lower pond and the upper pond subcatchments and to analyze the effects and routing of stormwater during various storm events. The rainfall data was collected through two means: a depth probe placed on-site and the data from the Worcester Regional Airport rain gauge, which was discussed in section 5.2. ArcMap and Google Maps were used to collect information on the area, soil types, soil slopes, and contours to develop the HydroCAD model using the SCS Unit Hydrograph Method. Figure 15 shows an image of the HydroCAD Model and Table 15 displays the inputs for each node on the model.





**Figure 15:** A screenshot of the HydroCAD Model created to model the flow of stormwater at the EcoTarium.

**Table 15:** A display of the inputs in the HydroCAD model for each node.

Drainage Summary							
Catchment	Description	Hydraulic Length (ft)	Slope (ft/ft)	Tc (min)	Soil Slope	CN Value	Area (acres)
Catch. 1 (Lower Pond)	Grassy Median	370	0.0314	24.1	0	39	1.35
	Parking lot	400	0.0405	3.6	0	98	1.22
	Forested Hillside	300	0.140	4.0	D, C, B	73	4.15
	Roof/Back of building	350	0.10	6.1	0	68	1.14
	Rock Face	250	0.10	2.7	C	86	1.28
	Patio	200	0.05	3.2	0, C	86	1.66

Catch. 2 (Upper Pond)	Driveway	335	0.012	5.7	C	98	.25
	Grassy Median	210	0.01	15.4	C	61	0.103
	Forested Area	220	0.045	4.9	C	77	2.44
	Parking lot	220	0.014	3.8	C	98	0.645

When creating the model all of the subcatchments at the EcoTarium were accounted for. Each sub catchment was giving a unique CN value or runoff curve number. The CN value is used to represent runoffs or infiltration of stormwater. For example, impervious pavements have a high CN value of 98 which was given to multiple sub catchments in the EcoTarium including the parking lots and roofs. The hydraulic length, soil slopes, and time of concentration were also all calculated in the model. The hydraulic length was measured for each location to calculate how long each sub catchment is. Soil slopes were found using the GIS file created and previously mentioned. The time of concentration was calculated by the HydroCAD application. The time of concentration is the time for the runoff to enter the sub catchment and flow to the outlet. Most subcatchments consisted of different surfaces because the HydroCAD application being used only allowed for a maximum of 21 nodes. Overall, the subcatchments CN value were accurately represented because they were grouped with similar surface types and CN values in mind.

## 6.0 Design

In this section our group identified five different BMP solutions that can be implemented into two separate locations at the EcoTarium to improve the water quality of the runoff on the site. To do this, we used our previous analysis of our data to find locations where the flow is concentrated to implement BMPs and to determine which contaminants treatment should focus on.

### 6.1 Concept Designs

BMPs were narrowed down from the Massachusetts Stormwater Handbook and the remaining ones became these solutions (Massachusetts Department of Environmental Protection, 2008). The following options are for the upper and lower pond areas. They were divided into two subbasins based on which pond the water would flow into. The subbasins can be found in Figure 14 in Section 5.4. To decontaminate the runoff flowing into both locations, BMP design options need to be selected for both pond locations. These options are in no particular order.

#### 6.1.1 Design Options for Upper Pond Area

Three options were considered for the upper pond area:

1. An oil/grit separator and infiltration trench
2. A vegetated filter strip and sand filter
3. A vegetated filter strip and rain garden

##### *Design Option 1: Oil/Grit Separator and Infiltration Trench*

An oil/grit separator is a BMP that is primarily used to separate sediment and oil from storm runoff. It uses gravity and retention time to remove about 25% of TSS. To clean an oil/grit separator of accumulated oil and grease, a vacuum truck, or other catch basin cleaning device, needs to be used. This needs to be done at least twice a year. Inspection of the separator should also be done after major storms to ensure nothing is clogging it. For our designs we used a First Defense 3-foot High Capacity (FD-3HC) oil/grit separator designed by Hydro International (Hydro International, 2019).

Infiltration trenches are simple BMPs that use gravel to remove pollutants while stormwater is filtered through it. As simple as they are, infiltration trenches are very effective at removing water contaminants. When paired with a BMP for pretreatment, such as an oil/grit separator, these trenches have the capability to remove 80% of the TSS. They can also remove the following contaminants:

- Total nitrogen: 40 to 70%
- Total phosphorus: 50 to 70%
- Metals: 85 to 90%
- Pathogens: up to 90%

To maintain these removal rates, infiltration trenches need to be inspected every six months and after every major storm for blockage. Sediment from the pretreatment BMP should also be removed at the same frequency.

In our design of an oil/grit separator and infiltration trench, a few assumptions were made. These assumptions are:

- Water table is at the height of the pond, 557 feet.
- The starting ground level at the northwestern corner of the parking lot, 564 feet.

- The oil grit separator drops the water 2 feet when it releases it into the infiltration trench.
- The trench needs to be a minimum of 3 feet deep.
- The water table should be at least 2 feet below the bottom of the infiltration trench and still a foot below when the water level is high.
- One inch one-hour storm volume = 2,280.957 gallons (304.92 feet<sup>3</sup>).
  - Peak treatment flow is 0.84 cfs.
- The porosity of the stone in the infiltration trench is 0.3.

Water flows into the system from the catch basin in the corner of the parking lot. The water then flows into the FD-3HC oil/grit separator through an 8" CPP pipe. The FD-3HC's size was chosen based on the estimated flow from the one inch, one-hour storm (Narayanan & Pitt, 2006). The flow from the upper parking lot was low enough that the smallest model, FD-3HC, would be sufficient. In the case of larger storms, the FD-3HC has an overflow that prevents the contaminants from being flooded out. The flow then continues through the 8" pipe into the infiltration trench (Hydro International, 2019). The infiltration trench was designed to be 24 feet long, 3 feet deep, and 13.5 feet wide, to hold the flow volume of the one-inch storm. The infiltration trench is designed to be lined with filtration fabric on the sides and bottom and filled with 2-5" washed stone. The infiltration trench was designed to hold a 12" perforated pipe in its center to allow for an outflow from the infiltration trench in case the flow exceeds the storage volume of the trench. Manholes should also be added before and after the infiltration trench to allow for maintenance and additional water storage. The location of the oil/grit separator and infiltration trench can be seen in Figure 16.



**Figure 16:** The location of the oil/grit separator and infiltration trench compared to the upper lot. The outline of the upper parking lot can be seen next to the oil/grit separator. The pond can be seen above the infiltration trench.

The removal of TSS, phosphorus, and bacteria was a priority in the system's design. Therefore, the concentrations of each of those contaminants were decreased by at least half,

pathogens being removed at up to a single log removal. The amount of removal can be seen in Table 16.

**Table 16:** Contaminant removal percentages for the upper lot design option 1. “-” notes insufficient data from Mass Stormwater Handbook (Massachusetts Department of Environmental Protection, 2008)

BMP	TSS Removal (%)	Total Phosphorus (%)	Total Nitrogen (%)	Total Metals (%)	Pathogens (%)
Oil-Grit Separator	25	-	-	-	-
Infiltration Trench	80	50-70	40-70	85-90	up to 90
Cumulative Removal Percentage	85	50-70	40-70	85-90	up to 90

The infiltration trench in this location can be used educationally to explain stormwater management and flow. Placing a sign by where the infiltration trench and the path meet to explain the infiltration trench’s purpose in keeping the pond’s contamination low. The system is also sustainable, requiring no further materials after its initial construction. The system will however require maintenance, requiring cleaning every 6 months or after major storms and a monthly inspection.

*Option 2: Sand Filter and Vegetated Strip*

Design option 2 will include a sand filter and a vegetated filter strip on the northern edge of the upper parking lot at the EcoTarium to catch the stormwater from the surrounding area. The sand filter will work well in this area due to the low area of contamination. The runoff from the parking lot will flow first into the vegetative filter strip and then into the sand filter and be discharged into the upper pond with less concentrations of contaminants.

A vegetated filter strip is a uniformly graded strip that typically treats sheet flow. The filter strips are best used to treat flow running off roads, highways, and in this case small parking lots. They are primarily designed to reduce TSS, but also have the ability to reduce heavy metals, nutrients and hydrocarbons. Vegetated filter strips can be comprised of grasses, shrubs, trees, and other native vegetation (EPA Vegetative filter Strips, 2006)

Sand filters are primarily used to remove total suspended solids, as well as total and particulate phosphorus. The filters can also help remove total nitrogen, metals, bacteria, and hydrocarbons. They are typically used as trenches along a parking lot because sand filters are generally well suited for a catchment that is 5 acres or less. Sand filters should be located off-line from a primary detention or conveyance system to prevent clogging and overflowing. A typical sand filter consists of 4 layers which are from top to bottom sand, gravel, geotextile fabric, and some type of piping for the water to flow out of the system (EPA Sand Filters, 2006)

The vegetated filter strip and the sand filter complement each other as an effective BMP solution. Vegetated filter strips are not recommended as standalone BMPs especially if the runoff is coming from a highly impervious area. The vegetated filter strips are best used as a pretreatment system to other BMPs. In this case the sand filter is being placed behind the vegetative filter strip and in front of the upper pond. Having the vegetated strip in front of the

sand filter will reduce peak flows and also reduce the amount of contaminants the sand filter will have to treat.

A vegetated filter strip can be effective at preliminary removal of TSS if constructed properly. For proper construction the vegetated filter strip will need:

- Minimum length for a filter strip is 25 feet
  - Shorter length could provide some water quality benefits also
- Filter strip slope should not exceed 8%, slopes less than 5% are generally preferred
- Filter strips should cause as little disturbance to existing vegetation at the site as possible.
- Filter strips should equal the width of the contributing drainage area.

The sand filter can be very effective at removing various contaminants if constructed properly, the sand filter will need:

- Approximately a max drainage area of 5 acres
- Minimum bedrock depth of 3 feet
- Minimum site slope of 10%
- A minimum of 18-inch top layer of 0.02-0.04-inch diameter sand
- Under sand should be a minimum of 2 inches of 0.5-2-inch diameter gravel
- The underdrain pipe should be a minimum of 4-inch diameter
- The pipe should be schedule 40 polyvinyl chloride (PVC) strength or greater
- The pipe perforation should be 3/8 inch
- Max spacing of perforation should be no greater than 6 inches
- Should be a geotextile fabric in between each layer
- Access for cleaning the underdrain piping in needed

The removal efficiencies of phosphorus and pathogens of the sand filter were found to be insufficient for this design option, decreasing phosphorus by less than half and not having removal data for pathogens. TSS and metals are the only contaminant removals with efficiencies above half. Table 17 shows the removals of the different contaminants.

**Table 17:** Contaminant removal percentages for the upper lot design option 2. “-” notes insufficient data from Mass Stormwater Handbook (Massachusetts Department of Environmental Protection, 2008)

BMP	TSS Removal (%)	Total Phosphorus (%)	Total Nitrogen (%)	Total Metals (%)	Pathogens (%)
Vegetated Filter Strip	10	-	-	-	-
Sand Filter	80	10-50	20-40	50-90	-
Cumulative Removal Percentage	82	10-50	20-40	50-90	-

The vegetated filter strip would separate the parking lot and the sand filter to allow for some TSS removal and to not clog the sand filter. The location of this design is shown in Figure 17.





**Figure 17:** The location of the vegetated filter strip and sand filter. The vegetated filter strip lines the corner of the upper parking lot and the sand filter runs to the edge of the upper pond.

While the sand filter adds little aesthetic value, it would provide an educational opportunity for the EcoTarium. The sand filter could teach children about percolation with water moving through the sand.

### *Option 3: Vegetated Filter Strip and Rain Garden*

Design option 3 for the upper pond is a rain garden on the northwestern corner of the upper parking lot in front of the pond preceded by a vegetated filter strip.

Rain gardens are gardens with native plants that are designed to temporarily hold stormwater runoff. They are designed to hold water for no longer than 48 hours to prevent the breeding of mosquitoes. Typically, there is about 6 inches of ponding space to retain the runoff. When properly designed they have the capability to remove:

- TSS: 90% with vegetated filter strip or equivalent
- Total Nitrogen: 30 to 50% if soil media is at least 30 inches
- Total Phosphorus: 30 to 90%
- Total Metals: 40 to 90%

By trapping and retaining water for less than 48 hours, these gardens lessen the runoff flow rate. Adding this to the upper pond lot would allow for less rainwater to enter the upper pond mitigating the risk of flooding during the rainy season.

To maintain a rain garden little to no extra maintenance is needed compared to normal garden upkeep. Annual mulching, fertilizing, and pruning are required. Removal of dead

vegetation should also be done every year or as needed. The garden should also be checked for litter monthly, any found should be removed.

The rain garden will add both contaminant removal and an aesthetic aspect to the pathway around the pond. A list of recommended plants for a rain garden in New England can be found in Appendix N. The plants chosen for the rain garden will affect the removal efficiencies of contaminants. The typical ranges of the contaminant removal for rain gardens can be found in Table 18.

**Table 18:** Contaminant removal percentages for the upper lot design option 3. “-” notes insufficient data from Mass Stormwater Handbook (Massachusetts Department of Environmental Protection, 2008)

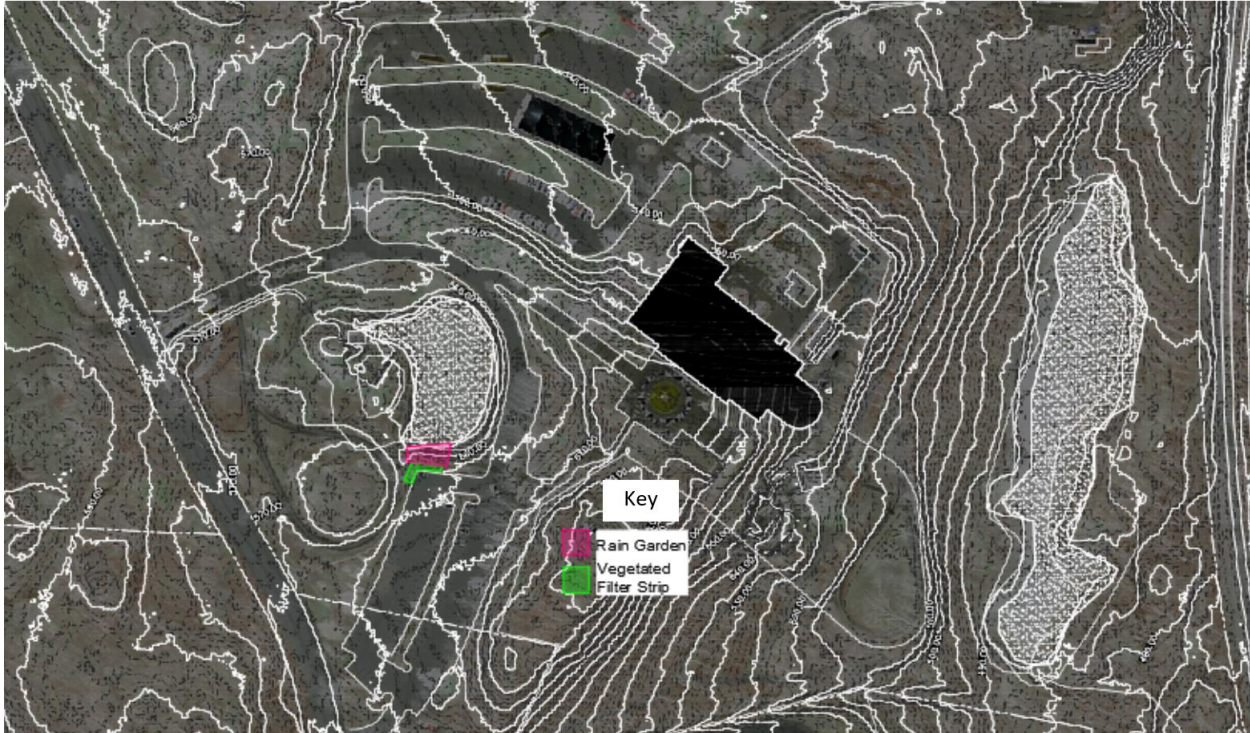
BMP	TSS Removal (%)	Total Phosphorus (%)	Total Nitrogen (%)	Total Metals (%)	Pathogens (%)
Vegetated Filter Strip	10	-	-	-	-
Rain Garden	80	10-50	20-40	50-90	-
Cumulative Removal Percentage	18	50-90	60-80	10-50	-

The assumptions that were made for the design of the rain garden include:

- Water table is at the height of the pond, 557 feet.
- The starting ground level at the corner of the parking lot is shown as an ArcMap screenshot and is at 564 feet.
- One inch one-hour storm volume = 2,280 gallons (305 feet<sup>3</sup>).

The rain garden was designed to be in the location shown in Figure 18. In this location, the rain garden would add aesthetic value to this location and be accessible to the general public due to the level of foot traffic around the upper pond and the otter exhibit. The rain garden could be used to show off different plants where each plant is described in their function.





**Figure 18:** The location of the vegetated filter strip and rain garden in the upper lot. The vegetated filter strip makes an L shape around the northwest corner of the upper parking lot and the rain garden runs above the filter strip across the pathway to the edge of the upper pond area.

To have the garden work in this area it will interfere with the existing pathway. It will need to be designed to not be affected by the puddling of the stormwater. Our design would replace the pathway with a wooden bridge that would allow the puddled water to flow underneath, and not interfere with the puddling of the water on the surface of the rain garden. A rain garden would limit the total amount of rainfall flowing into the upper pond. It would still allow for some flow from the water that percolates into the perforated pipe but overall reduce the volume. Theoretically, during the rainier seasons this would prevent flooding into the otter exhibit.

### 6.1.2 Design Option for Lower Pond Area

Two options were considered for the lower pond area:

1. An oil/grit separator and infiltration trench
2. A vegetated filter strip and rain garden

#### *Option 1: Oil/Grit Separator and Infiltration Trench*

The first option for the lower pond, similar to the first option for the upper pond, is a combination of an FD-3HC oil/grit separator and an infiltration trench. Both individual BMPs are explained more in the description of the upper pond option.

The assumptions that were made in this design are as follows:

- The water table is assumed to be lower than the stream.
- The catch basin is at 533 feet and would drop down 2 feet to the pipe that leads to the oil/grit separator.

- The infiltration trench will have 3 feet of depth and can run into where the stream starts currently, giving a good visual example of the BMP for educational purposes.
- One inch one-hour volume = 2932.66 gal (392.04 ft<sup>3</sup>)
  - Peak treatment flow is 0.84 cfs

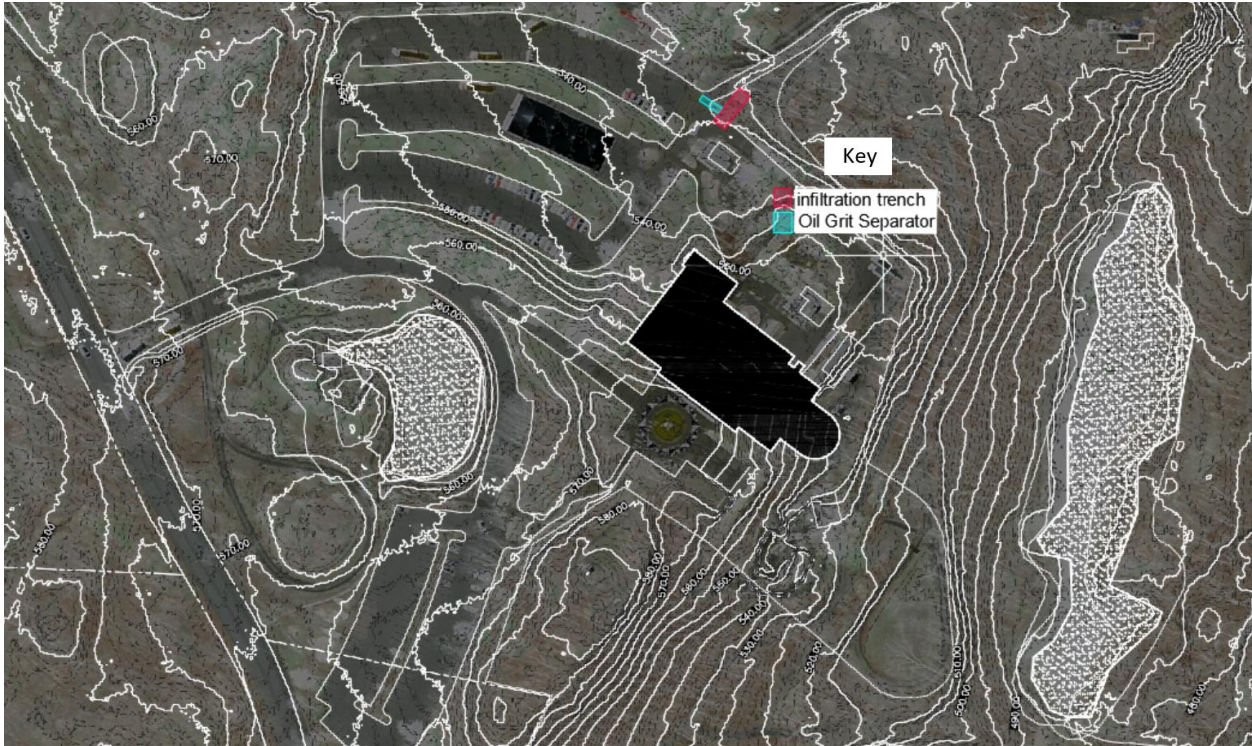
Option 1 for the lower pond is implementing an oil/grit separator immediately followed by an infiltration trench. The oil/grit separator implemented before the stream, will take its water from the outflow of the catch basin at the corner of the lower parking lot. The system will be underground and then flow into a FD-3HC oil/grit separator through an 8” PCC pipe. The FD-3HC’s size was chosen because the model would be able to handle the estimated flow from the 1-inch storm (Narayanan & Pitt, 2006). The outflow of the FD-3HC will be an 8” pipe with an elbow at the end that runs into the infiltration trench that would run 35 feet into the stream. The trench would be a continuous 3 feet deep and 11.5 feet wide and run a 12” perforated pipe through the entire 35 ft. The existing catch basin may need to be refitted to connect to the oil/grit separator. The cost analysis was done much the same as the oil/grit separator and infiltration trench done in the upper pond with a slightly higher cost for excavation.

The removal of TSS, phosphorus, and bacteria were a priority in the design. Therefore, the concentration of each of those contaminants were decreased by at least half, pathogens being removed at up to a single log removal. The amount of removal can be seen in Table 19.

**Table 19:** Contaminant removal percentages for the lower lot design option 1. “-” notes insufficient data from Mass Stormwater Handbook (Massachusetts Department of Environmental Protection, 2008)

BMP	TSS Removal (%)	Total Phosphorus (%)	Total Nitrogen (%)	Total Metals (%)	Pathogens (%)
Oil-Grit Separator	25	-	-	-	-
Infiltration Trench	80	50-70	40-70	85-90	up to 90
Cumulative Removal Percentage	85	50-70	40-70	85-90	up to 90

The infiltration trench would outflow to the stream allowing for an aesthetically pleasing look where the water flowing into the stream. The location can be seen in Figure 19. The system is sustainable, requiring no further materials after its initial construction. The system will however require maintenance, requiring cleaning every 6 months or after major storms and a monthly inspection.

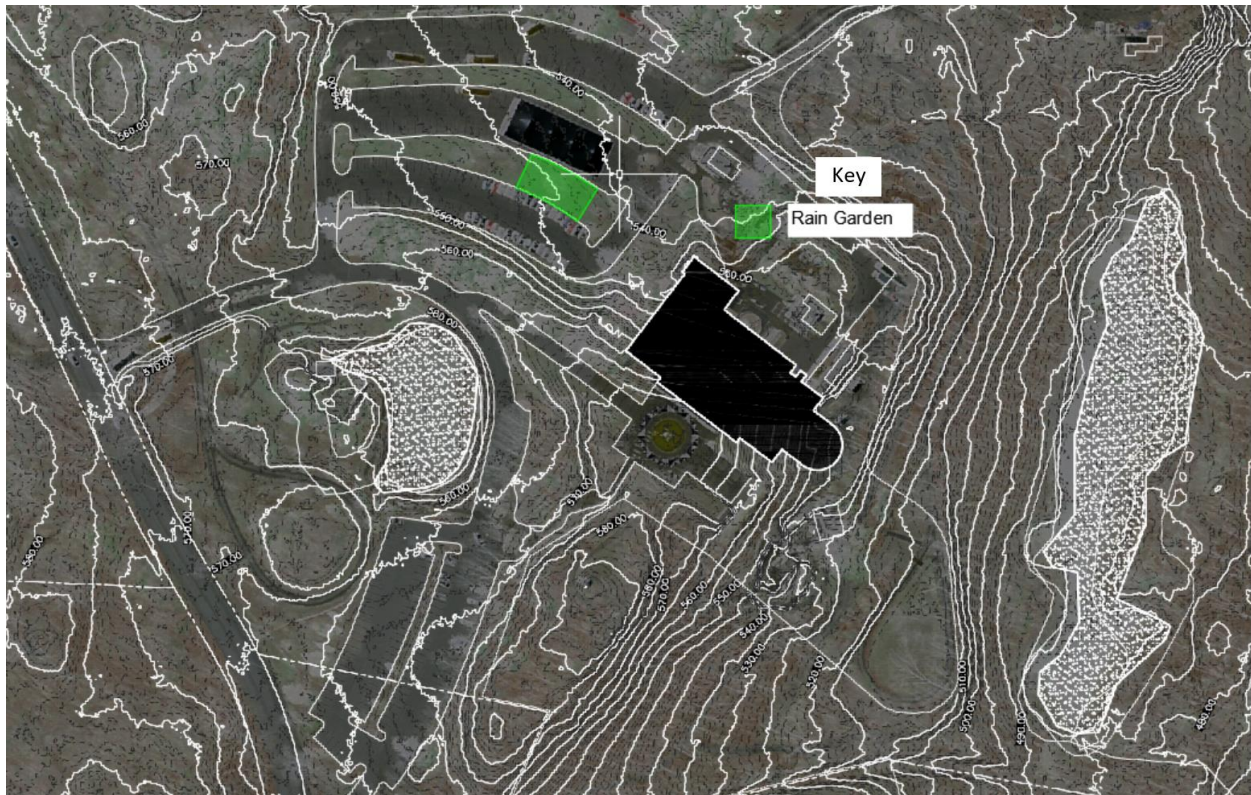


**Figure 19:** The location of the oil/grit separator and infiltration trench. The oil/grit separator runs from the catch basin at the corner of the lower parking lot to the infiltration trench. The infiltration runs perpendicular to the oil/grit separator and the stream, running between them.

### *Option 2: Rain Garden*

Option 2 for the lower pond is implementing a rain garden in the lower parking lot, shown in Figure 20. The lower parking lot has three grassy medians that stormwater flows into which make it a great area for a rain garden. The rain garden is a type of bioretention area, which treats stormwater by pooling water on the surface and allowing for filtering and settling of the contaminants through the garden. The contaminants are filtered using soil and plant material which take up contaminants. The filtration efficiency is tabulated in Table 20.





**Figure 20:** The location of the rain garden in the lower parking lot. The rain garden is placed in one of the grass strips in the lower parking lot.

**Table 20:** Contaminant removal percentages for the lower lot design option 2. “-” notes insufficient data from Mass Stormwater Handbook (Massachusetts Department of Environmental Protection, 2008)

BMP	TSS Removal (%)	Total Phosphorus (%)	Total Nitrogen (%)	Total Metals (%)	Pathogens (%)
Rain Garden	80	10-50	20-40	50-90	-

A rain garden usually consists of a cross section from top to bottom: deep rooted plants, a top layer of mulch, 2 feet of soil, 6-8 inches of gravel and a perforated pipe for overflow at the bottom.

The rain garden will be effective for treating contaminants from flowing into the stream that feeds the lower pond. The rain garden will lower peak flows by slowing down the flow of water through infiltration. The rain garden will also add an aesthetic aspect to the lower lot and give shaded cover to the parked cars. They also require annual maintenance like re-mulching, pruning, and monthly debris cleanout.

A list of recommended plants for a rain garden in New England can be found in Appendix N.

## 6.2 Comparisons of Designs

Table 21 compares the more quantitative differences of the designs previously described. When choosing designs to focus on, our group mainly took into account the TSS, phosphorus, and pathogen removals, the aesthetic of the design, and the possible educational value.

**Table 21:** Comparison of the different design options (Massachusetts Department of Environmental Protection, 2008).

	Upper Pond			Lower Pond	
	Oil/Grit Separator and Infiltration Trench	Vegetated Filter Strip and Sand Filter	Vegetated Filter Strip and Rain Garden	Oil/Grit Separator and Infiltration Trench	Vegetated Filter Strip and Rain Garden
TSS Removal	85%	82%	90%	85%	90%
Phosphorus Removal	50-70%	10-50%	30-90%	50-70%	30-90%
Pathogen Removal	Up to 90%	*	*	Up to 90%	*
Nitrogen Removal	40-70%	60-80%	30-50%	40-70%	30-50%
Metal Removal	85-90%	10-50%	40-90%	85-90%	40-90%
Surface Area Required	340 ft <sup>2</sup> (underground)	400 ft <sup>2</sup>	610 ft <sup>2</sup>	430 ft <sup>2</sup> (underground)	760 ft <sup>2</sup>
Maintenance	Monthly: Inspect  Twice a Year: Clean out the system	Twice a Year: Inspect and clean	Monthly: Remove trash Mow  Annual: Mulch Fertilize Prune General upkeep	Monthly: Inspect  Twice a Year: Clean out the system	Monthly: Remove trash Mow  Annual: Mulch Fertilize Prune General upkeep

\* = The Massachusetts Stormwater Handbook does not have data on the removal of this contaminant for this group of BMPs

The qualitative differences between the designs include the aesthetics and educational value. The aesthetic quality of the rain garden designs match those of the EcoTarium being a

nature museum. Being a nature museum, an additional educational value for the design would be beneficial. A rain garden can be used to teach children about the plants used in the garden, or an infiltration trench would be able to show information on water flow through the gravel.

The location is an additional parameter to consider. The two locations, the upper parking lot and lower parking lot, give three main differences: the presence of oil in the lower pond, the different flow volumes, and the upper pond's pathway that allows the public to walk towards the otter enclosure. The presence of oil on the surface of the lower parking lot is likely a result of the heavy use by vehicles, which can affect the ecosystem. Removal of the oil with an oil/grit separator would benefit the health of that environment. The flow volume in the lower parking lot was higher as there was a larger area that flows to that location compared to the upper parking lot. This makes any BMP solution implemented in the lower lot have to hold a larger volume. The final difference is the pathway by the upper pond. Due to the pathway being traveled to reach the otter exhibit. The presence of an aesthetically pleasing and educational BMP solution would be most effective at this location.

### 6.3 Final Design of Options

The recommended designs chosen for finalized BMP design included the vegetated filter strip and rain garden in the upper parking lot and the oil/grit separator and infiltration trench for the lower parking lot. The vegetated filter strip and rain garden were chosen for the upper lot due to the existing pathway being there allowing for immersive access to the public that the rain garden adds. The oil/grit separator and infiltration trench were chosen for the lower lot because of the oil removal and presence of the existing catch basin system. The lower pond has visible oil on the surface, removal of this contaminant from the pond can improve the health of the ecosystem. A drawing of each BMP and a preliminary cost analysis is included below.

#### 6.3.1 Upper Lot Area

We suggest building a vegetative filter strip and a rain garden in the northwestern corner of the upper lot of the EcoTarium. In this location the rain garden would be able to collect the most amount of storm runoff. Where we are suggesting installing a rain garden is through an existing walkway. Due to the nature of rain gardens, which involve puddling of rainwater, a specialized walkway is needed. We suggest designing a bridge walkway similar to the existing bridge near the otter exhibit. The bridge needs to be more than 6 inches from the bottom of the rain garden to avoid getting flooded during puddling.

The rain garden would also be an excellent opportunity for the EcoTarium to make a learning opportunity for their visitors. With the bridge going through the garden, they can add a plaque explaining what the area is and what it does.

#### *Area Needed for Rain Garden*

- One inch one-hour storm volume = 2,280.96 gallons (304.92 feet<sup>3</sup>).
- Depth of rain garden = 6 inches

Area of rain garden:

$$\text{Area} = \text{One inch hour storm volume} / \text{depth of rain garden}$$

$$\text{Area} = 304.92 \text{ ft}^3 / 0.5 \text{ ft}$$

$$\text{Area} = 609.84 \text{ ft}^2$$

The rain garden will be 4.33 feet deep. The layers will be 6 inches for ponding, 2 inches of mulch, 3 feet of soil, and 8 inches of gravel with an 8-inch perforated pipe running through it. The drawings of the schematics are in Appendix O.

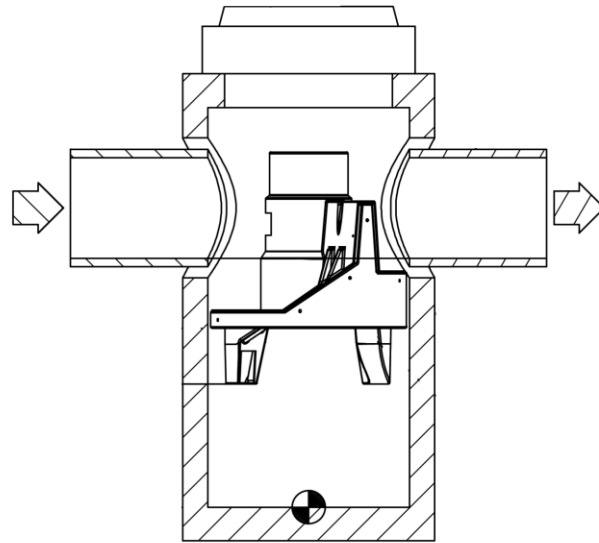
The costs associated with this design are tabulated in Table 22. The costs were found using *RS Means Site Work & Landscape Cost Data* (RS Means, 2011). The number of plants were estimated, and the price could vary heavily. The cost to haul the excavated soil was conservatively estimated with the assumption that the entirety of the excavated soil would be hauled off site. It was also assumed that the site that the soil would have to be brought to would be within ten miles of the EcoTarium and the average speed would be 35 mph.

**Table 22:** The costs associated with the construction of the vegetated filter strip and rain garden in the upper lot. Labor and material costs are included (RS Means, 2011). All costs were rounded up to the nearest ten.

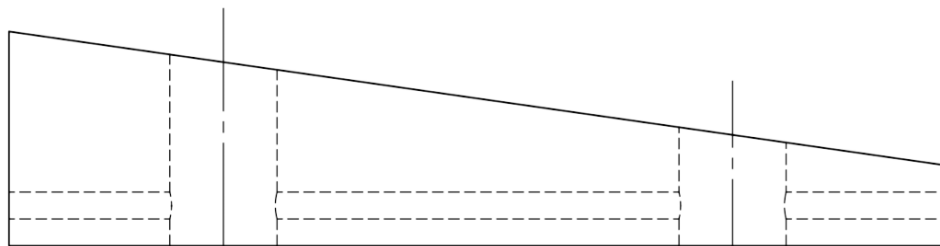
	Cost per unit	Unit	Number of units	Cost
Excavation 1'-4'	\$8.75	Cubic Yard	89.6	\$790
Excavation 4'-6'	\$6.75	Cubic Yard	22.4	\$160
Gravel fill	\$1.09	Cubic Yard	15	\$20
Soil fill from excavation	\$1.24	Cubic Yard	68	\$90
Mulch fill	\$44.00	Cubic Yard	3.8	\$170
Mulch spread	\$35.00	Cubic Yard	3.8	\$140
Haul	\$5.40	Cubic Yard	30.1	\$170
6" perforated pipe	\$3.10	Foot	80	\$250
Plants	\$20.00	Each	35	\$700
Clear brush and trees	\$6,100.00	Acre	0.014	\$90
Manhole	\$1,425.00	Each	1	\$1,430.00
<b>Total</b>				<b>\$4,010</b>

### 6.3.2 Lower Lot Area

The BMP design that was chosen for the lower parking lot was the oil/grit separator and infiltration trench. This is a good solution for this area due to the existing catch basin system throughout the parking lot. This catch basin system allows for the storm water to be centralized and channeled into the FD-3HC system. Without the existing catch basins, for this design to work, the parking lot would have needed to be dug up and repaved afterwards. Instead only a small part of it needs to be dug up. Like the rain garden, the infiltration trench will go through an existing walkway. We recommend creating a bridge like the ones crossing the stream to allow the walkway to continue. The drawings of the oil/grit separator and infiltration trench are in Figures 21 and 22. Detailed technical drawings are in Appendix P and Q.



**Figure 21:** Front view of FD-3HC, photo altered (Hydro International, 2019) technical drawing in Appendix P.



**Figure 22:** Front view of infiltration trench with two manholes. Technical drawing can be found in Appendix Q.

*Infiltration Trench Volume Calculations*

- Volume required to handle: 392.04 feet<sup>3</sup>
- Estimated length from outflow of FD-3HC pipe to stream: 35 feet
- Porosity of gravel: 0.3
- Perforated pipe: 12 inches

Volume of gravel + volume of long pipe + volume of short pipe = volume of infiltration trench

$$0.3 [ 3ft (35ft)(x) ] + [ \pi(0.5ft)^2(35ft) ] + [ \pi(0.5ft)^2(\frac{x}{2}) ] = 392.04ft^3$$

$$31.5x + 27.49 + 0.39x = 392.04$$

$$31.89x = 364.55$$

$$x = 11.43ft \rightarrow 11.5 ft$$

Dimensions: 35ft x 11.5ft x 3ft



The costs associated with this design are tabulated in Table 23. The costs were found using *RS Means Site Work & Landscape Cost Data* (RS Means, 2011). The cost of the FD-3HC was a rough estimate that was given by Coleman Horsley (Coleman Horsley, personal communication, 2020). The cost to haul the excavated soil was estimated by conservatively estimating that the entirety of the excavated soil would be hauled off site. It was also assumed that the site that the soil would have to be brought to would be within ten miles of the EcoTarium and the average speed would be 35 mph.

**Table 23:** The costs associated with the construction of the oil/grit separator and infiltration trench in the lower lot. Labor and material costs are included (RS Means, 2011). All costs were rounded up to the nearest ten.

	Cost per unit	Unit	Number of units	Cost
Excavation 1' - 4'	\$8.75	Cubic Yard	47	\$420
Excavation 4' - 6'	\$6.75	Cubic Yard	0.67	\$10
Excavation 6' - 10'	\$7.45	Cubic Yard	0.5	\$10
8" Pipe	\$3.57	Linear Foot	17	\$70
Elbow	\$27.50	Each	1	\$30
12" Perforated Pipe	\$25.50	Linear Foot	35	\$900
FD-3HC	\$20,000.00	FD-3HC	1	\$20,000.00
Gravel	\$1.09	Cubic Yard	44.72	\$50
Haul	\$5.40	Cubic Yard	47	\$260
Pavement Patching	\$133.00	Each	1	\$140
Manhole	\$1,425.00	Each	1	\$1,430.00
<b>Total</b>				<b>\$23,320</b>

## 7.0 Conclusion and Recommendations

The goal of this project was to characterize the contaminants in stormwater runoff flowing into the EcoTarium's two on-site ponds so that effective BMPs could be designed. This was achieved through sampling stormwater during four rain events at the EcoTarium. When testing the collected stormwater, it became apparent that total phosphorus and pathogens were of the highest concern at the concentrations that they were found. Although contaminants were a critical part of the design, there was an attempt to have an aesthetic and educational aspect to the designs.

After approximately 30 weeks of research, testing, and analysis of what BMP systems would work best at the EcoTarium, we have concluded that a vegetative strip and a rain garden for the upper pond, as well as an oil/grit separator and an infiltration trench for the lower pond would be the most effective designs for water contaminant removal and flow regulation. The vegetated filter strip and rain garden would be placed between the upper parking lot and the upper pond where the vegetated filter strip would run along the corner of the parking lot as a buffer before the rain garden. The rain garden was considered a great option for the aesthetic and educational value that it could bring to the site. Both being able to teach about the plants placed in the garden and the pure aesthetic value that those plants would add. The oil/grit separator and infiltration trench would run from the existing catch basin in the lower parking lot into the stream. The oil/grit separator would be an important addition for the health of the pond as the pond currently has visible oil contamination. Both the infiltration trench and rain garden are able to remove high levels of pathogens and phosphorus, allowing both designs an overall effective amount of contaminant removal.

When comparing lab results from this report's data at the EcoTarium to the data collected by the Nitsch Engineering sponsored '18 - '19 MQP the previous year which tested samples from WPI's campus, there were many similarities in contaminant concentrations for common surface types. The parking lots at the EcoTarium and WPI shared similar results when comparing the contaminant concentrations; both lots had almost identical total phosphorus, magnesium, lead, copper, and sodium concentrations. While the two lots differed in sulfate, ammonia, and especially chloride and nitrate. WPI had higher concentration of chloride while the EcoTarium had higher concentrations of nitrate. The roofs for each location also had very similar contaminant concentrations which included, sodium, sulfate, and chloride. The only apparent difference in concentrations was the calcium, at the EcoTarium there was approximately 0.6 mg/L more calcium coming from roof water runoff. The pathogen concentrations could not be compared due to the lack of testing for pathogens in the '18 - '19 MQP.

The next steps in this project would be to continue the design process of the BMPs at the EcoTarium. The BMP solutions should be proposed to the EcoTarium and its members to show how each design could benefit the water quality of the two on-site ponds. The design should be discussed with cost, size, aesthetics, and treatment capabilities in mind.

## References

- Adamic, E., Jarosz-Krzemińska, E., & Wieszała, R. (2016). Heavy metals from non-exhaust vehicle emissions in urban and motorway road dusts. *Environmental Monitoring and Assessment*, 188(6), 1-11. doi:10.1007/s10661-016-5377-1
- Adams, B. J. (2000). *Urban stormwater management planning with analytical probabilistic models*. United States: Retrieved from
- Adell, A. D., McBride, G., Wuertz, S., Conrad, P. A., & Smith, W. A. (2016). Comparison of human and southern sea otter (*Enhydra lutris nereis*) health risks for infection with protozoa in nearshore waters. *Water Research*, 104, 220-230. doi:10.1016/j.watres.2016.08.004
- Aguirre, A. A., Daszak, P., & Ostfeld, R. (2012). *New directions in conservation medicine*. US: Oxford University Press.
- Algae bloom in small farm pond* (2007). .  
<https://www.flickr.com/photos/soilscience/5084241721>
- American Society of Civil Engineers. *Guidance on licensing and ethical responsibilities for civil engineers*
- American Society of Civil Engineers. (2019a). *Accreditation and ABET*
- American Society of Civil Engineers. (2019b). Getting licensed and certified.
- Brooks Applied Labs. (2016). *Advanced analytical services for the determination of heavy metals in stormwater* Brooks Applied Labs, LLC.
- Conley, D. J., & Paerl, H. W. (2009). Controlling eutrophication: Nitrogen and phosphorous. *Science*, 323(5917), 1014-1015. Retrieved from
- EcoTarium museum of science and nature Retrieved from <https://ecotarium.org/about-us/history/>
- Environmental Protection Agency. Best management practices (BMPs) siting tool. Retrieved from <https://www.epa.gov/water-research/best-management-practices-bmps-siting-tool>
- Environmental Protection Agency. (1999, September). Storm Water Technology Fact Sheet Hydrodynamic Separators. Retrieved February 13, 2020, from <https://www.water-research.net/Waterlibrary/Stormwater/hydrodynamic.pdf>
- Environmental Protection Agency. (2009). *Industrial stormwater monitoring and sampling guide*. (). Retrieved from [https://www3.epa.gov/npdes/pubs/msgp\\_monitoring\\_guide.pdf](https://www3.epa.gov/npdes/pubs/msgp_monitoring_guide.pdf)
- Environmental Protection Agency. (2019a). 5.8 total solids.
- Environmental Protection Agency. (2019b). Learn about lead.

- Gorman Richardson Lewis Architects. *Worcester EcoTarium map*.  
<http://www.keywordbasket.com/d29yY2VzdGVyIGVjb3Rhcml1bSBtYXA/>
- Historical Weather. (2020). Retrieved from <https://www.wunderground.com/history>
- Ho lee, J., & Woong Bang, K. (2000). Characterization of urban stormwater runoff. *Water Research*, 34(6), 1773-1780. Retrieved from J. Wu, & Long, S. C. (2011). Are microbial indicators and pathogens correlated? A statistical analysis of 40 years of research. *Journal of Water and Health*, 9(2), 265-278.
- The Home Depot. (2020). homedepot.com. Retrieved February 13, 2020, from <https://www.homedepot.com/>
- Hydro International. (2019). *3-ft Diameter First Defense High Capacity*. Available at: <https://www.hydro-int.com/en/resources/first-defense-pdf-or-dwg-drawings>
- Keeghan M. O'Leary, Kimberly Yvonne Stanway, Lucas Alexander Acaba, Stephen A. Balcewicz, & Virginia Leigh Adams. (2019). *Quantifying the pollutant removal effectiveness of best management practices in urban watersheds* ().
- Krishna R. Reddy, Tao Xie, & Sara Dastgheibi. (2014). Nutrients removal from urban stormwater by different filter materials. *Water, Air, & Soil Pollution*
- Massachusetts Department of Environmental Protection. (2008). *Structural BMP specifications for the Massachusetts Stormwater Handbook* (Volume 2, Chapter 2)
- Minnesota Pollution Control Agency. (2018). *Bacteria in stormwater*
- NJSA. (2019). *Surface water quality standards*
- National pollutant discharge elimination system (NPDES): Applications and program updates*. (2019). (). Washington: Federal Information & News Dispatch, Inc. Retrieved from Research Library Prep
- Narayanan, A., & Pitt, R. (June 18, 2006). *Costs of Urban Stormwater Control Practices*. University of Arizona
- Oram, B. Bacteria, protozoans, viruses and nuisance bacteria need for water testing. Retrieved from <https://water-research.net/index.php/bacteria>
- Pennsylvania Stormwater Best Management Practices Manual. (2006). BMP 6.4.9: Vegetated filter strip (chapter 6), 99-112. Retrieved from [https://www.stormwaterpa.org/assets/media/BMP\\_manual/chapter\\_6/Chapter\\_6-4-9.pdf](https://www.stormwaterpa.org/assets/media/BMP_manual/chapter_6/Chapter_6-4-9.pdf)
- pH, buffers, acids, and bases Retrieved from <https://courses.lumenlearning.com/introchem/chapter/ph-buffers-acids-and-bases/>
- RSMeans. (2011). *RS Means Site Work & Landscape Cost Data* (30th ed.). Norwell, MA.
- Stormwater research at UVA. (2019).

- Minnesota Stormwater Manual. (2018). Bacteria in stormwater. Retrieved from [https://stormwater.pca.state.mn.us/index.php?title=Bacteria\\_in\\_stormwater](https://stormwater.pca.state.mn.us/index.php?title=Bacteria_in_stormwater)
- Swistock, B. (2015). Water quality concerns for ponds. *PennState Extension*
- VASSILIOS A. TSIHRINTZIS, & RIZWAN HAMID. (1997). Modeling and management of urban stormwater runoff quality: A review. *Water Resources Management*, 11(2), 136-164.
- Vo, K. Spectrophotometry. Retrieved from [https://chem.libretexts.org/Bookshelves/Physical\\_and\\_Theoretical\\_Chemistry\\_Textbook\\_Maps/Supplemental\\_Modules\\_\(Physical\\_and\\_Theoretical\\_Chemistry\)/Kinetics/Reaction\\_Rates/Experimental\\_Determination\\_of\\_Kinetics/Spectrophotometry](https://chem.libretexts.org/Bookshelves/Physical_and_Theoretical_Chemistry_Textbook_Maps/Supplemental_Modules_(Physical_and_Theoretical_Chemistry)/Kinetics/Reaction_Rates/Experimental_Determination_of_Kinetics/Spectrophotometry)
- Wu, J., Long, S. C., Das, D., & Dorner, S. M. (2011). Are microbial indicators and pathogens correlated? A statistical analysis of 40 years of research. *Journal of Water and Health*, 9(2), 265-278. doi:10.2166/wh.2011.117
- 314 CMR 4.00: Massachusetts surface water quality standards. (n.d.). Retrieved from <https://www.mass.gov/regulations/314-CMR-400-massachusetts-surface-water-quality-standards>
- (n.d.). Retrieved from Water Quality Impacts - Environmental, Health and Economic Impacts of Road Salt - Salt Reduction - Watershed Assistance Section
- (n.d.). Retrieved from <https://www.state.nj.us/dep/wms/bears/swqs-rules.htm>

## Appendices

**Appendix A: Table of various BMPs, descriptions and pollutant removal efficiencies**

BMP Category	BMP Name	Description	Pollutant Removal Efficiencies
Structural Pretreatment BMPs	Deep Sump Catch Basin	<ul style="list-style-type: none"> <li>- Underground retention systems meant to remove trash, debris, and coarse sediment from runoff</li> <li>- Also act as temporary spill containment devices</li> </ul>	<ul style="list-style-type: none"> <li>- TSS- 25% if pretreatment and designed as offline system</li> </ul>
	Oil/Grit Separators	<ul style="list-style-type: none"> <li>- Underground storage tanks with chambers meant to remove heavy particulates, floating debris and hydrocarbons</li> </ul>	<ul style="list-style-type: none"> <li>- TSS- 25% if pretreatment and placed offline</li> </ul>
	Proprietary Separators	<ul style="list-style-type: none"> <li>- Flow-through structure that has a settling/separation unit to remove sediment and other pollutants</li> </ul>	<ul style="list-style-type: none"> <li>- TSS- varies, must be used for pretreatment and be placed first in treatment train</li> </ul>
	Sediment Forebays	<ul style="list-style-type: none"> <li>- An excavated pit, bermed area, or cast structure paired with a weir to slow stormwater runoff and help with the separation of suspended solids</li> <li>- Different from sediment trap</li> </ul>	<ul style="list-style-type: none"> <li>- TSS- 25%</li> </ul>
	Vegetated Filter Strips	<ul style="list-style-type: none"> <li>- Grass buffer strips, uniformly graded vegetated surfaces</li> </ul>	<ul style="list-style-type: none"> <li>- TSS-</li> <li>- if <math>25' \leq \text{wide} &gt; 50'</math> 10%</li> <li>- If <math>50' \leq \text{wide}</math> 45%</li> </ul>
Treatment BMPs	Bioretention Areas and Rain Gardens	<ul style="list-style-type: none"> <li>- Soils, plants, and microbes treat stormwater</li> </ul>	<ul style="list-style-type: none"> <li>- TSS- 90% with vegetated filter strip or equivalent</li> <li>- Total Nitrogen- 30-50% if soil media is at least 30"</li> <li>- Total Phosphorus- 30-90%</li> </ul>

			- Metals- 40-90%
	Construction Stormwater Wetlands	- Man-made wetlands that temporary hold stormwater	- TSS - 80% when combined with sediment forebay for pretreatment - Total Nitrogen- 20-55% - Total Phosphorus- 40-60% - Metals 20-85% - Pathogens- up to 5%
	Extended Dry Detention Basins	- Modified conventional dry detention basins meant to hold stormwater for 24+ hours	- TSS- 50% when combined with sediment forebay - Total Nitrogen- 15-50% - Total Phosphorus- 10-30% - Metals- 30-50% - Pathogens- <10%
	Proprietary Media Filters	- Two-chamber underground concrete vaults	- TSS- variable, depends on media - Total Nitrogen- variable, depends on media - Total Phosphorus- variable, depends on media - Metals- variable, depends on media
	Sand and Organic Filters	- Self-contained beds of sand either underlaid with perforated underdrain or designed with cells and baffles with inlets/outlets	- TSS- 80% with one or more pretreatment BMPs - Total Nitrogen- 20-40% - Total Phosphorus- 10-5-% - Metals- 50-90%
	Wet Basins	- Permanent pool of water - Sediments settle at bottom	- TSS- 80% with sediment forebay

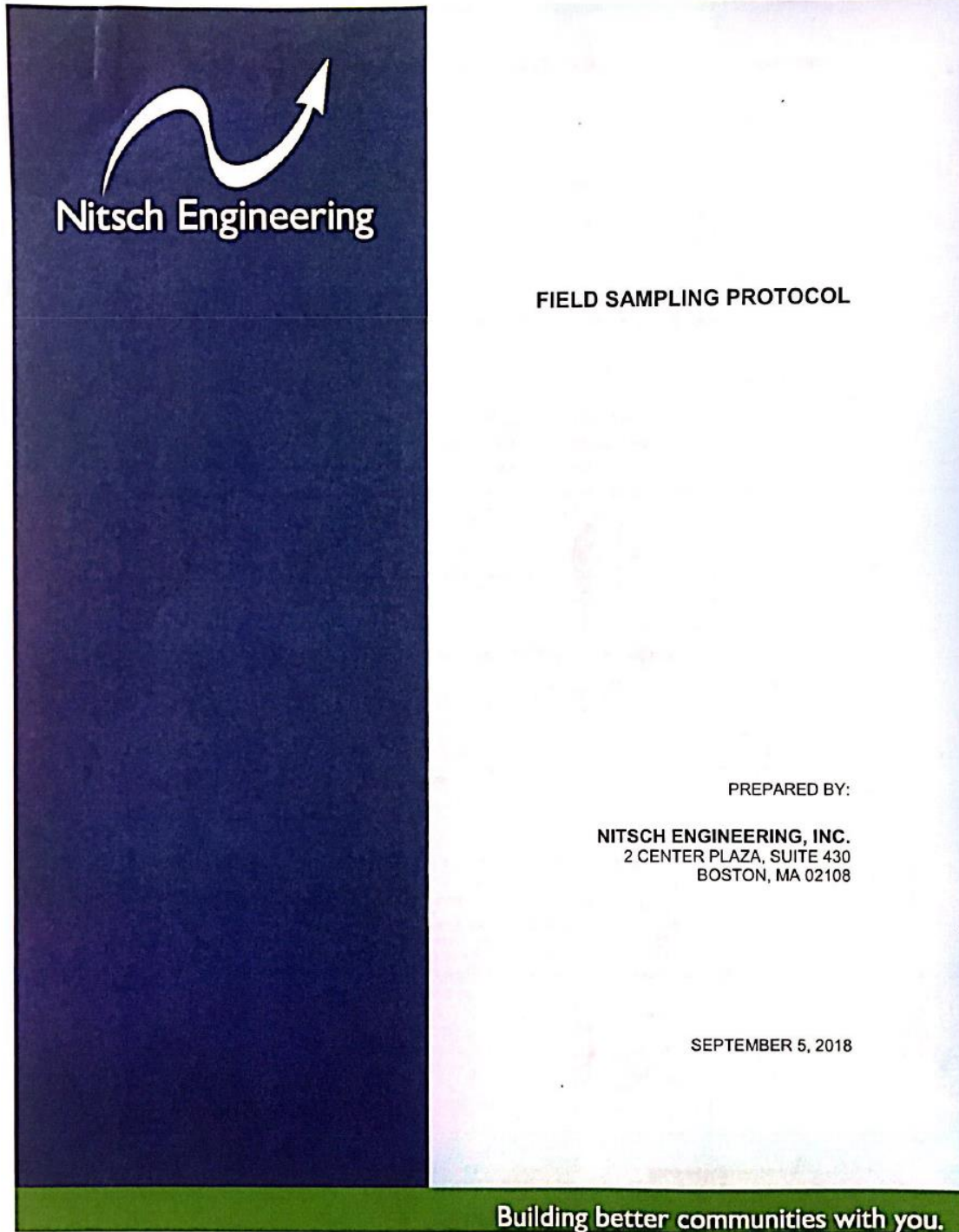
			<ul style="list-style-type: none"> <li>- Total Nitrogen- 10-50%</li> <li>- Total Phosphorus- 30-50%</li> <li>- Metals- 30-75%</li> <li>- Pathogens- 40-90%</li> </ul>
Conveyance BMPs	Drainage Channels	- Traditional vegetated open channels	- None
	Grassed Channel	- Grassed channels with long hydraulic residence time	<ul style="list-style-type: none"> <li>- TSS- 50% with pretreatment</li> <li>- Total Phosphorus- 121%*</li> </ul> <p style="text-align: right; margin-right: 20px;">*adds TP to system</p>
	Water Quality Swale	<ul style="list-style-type: none"> <li>- Vegetated open channels</li> <li>- Dry and Wet Swales</li> </ul>	<ul style="list-style-type: none"> <li>- TSS- 70% (dry) and 50% (wet) with pretreatment</li> <li>- Total Nitrogen- 10-90%</li> <li>- Total Phosphorus- 20-90%</li> </ul>
Infiltration BMPs	Dry Wells	- Small pits that collect runoff	- TSS- 80% from non-metal roofs
	Infiltration Basins	- Impoundments that are constructed over permeable soils	<ul style="list-style-type: none"> <li>- TSS- 80% with pretreatment</li> <li>- Total Nitrogen- 50-60%</li> <li>- Total Phosphorus- 60-70%</li> <li>- Metals- 85-90%</li> <li>- Pathogens- 90%</li> </ul>
	Infiltration Trenches	<ul style="list-style-type: none"> <li>- Shallow trenches filled with stone</li> <li>- Designed to capture sheet flow or pipe inflow</li> </ul>	<ul style="list-style-type: none"> <li>- TSS- 80% with one or more pretreatment BMPs</li> <li>- Total Nitrogen- 40-70%</li> <li>- Total Phosphorus 40-70%</li> <li>- Metals- 85-90%</li> <li>- Pathogens- up to 90%</li> </ul>



	Leaching Catch Basins	<ul style="list-style-type: none"> <li>- Concrete barrel that allows runoff to leach into the ground</li> <li>- Two configurations: standalone barrel/riser and barrel/riser combined with deep sump catch basins that provide pretreatment</li> </ul>	<ul style="list-style-type: none"> <li>- TSS- 80% if combined with deep sump catch basin and if designed to be offline</li> </ul>
	Subsurface Structures	<ul style="list-style-type: none"> <li>- Underground systems that capture runoff and slowly infiltrate into the groundwater</li> </ul>	<ul style="list-style-type: none"> <li>- TSS- 80%</li> </ul>
Other BMPs	Dry Detention Basin	<ul style="list-style-type: none"> <li>- Impounded/excavated basin for short term detention of runoff</li> </ul>	<ul style="list-style-type: none"> <li>- Total Nitrogen- 10-50%</li> <li>- Total Phosphorus- 10-30%</li> <li>- Metals- 30-50%</li> <li>- Pathogens- &lt;10%</li> </ul>
	Green Roofs	<ul style="list-style-type: none"> <li>- Permanent rooftop planting system</li> </ul>	<ul style="list-style-type: none"> <li>- Total Phosphorus- increases amount</li> </ul>
	Porous Pavement	<ul style="list-style-type: none"> <li>- Pavement with a higher percentage of air voids</li> </ul>	<ul style="list-style-type: none"> <li>- TSS- 80%</li> </ul>
	Rain Barrels and Cisterns	<ul style="list-style-type: none"> <li>- Rooftop runoff collectors</li> <li>- Reused water for landscaping and other non-potable uses</li> </ul>	<ul style="list-style-type: none"> <li>- Offers no removal benefit, rooftop runoff presumed to be clean</li> </ul>

(Mass Department of Environmental Protection, 2019)

Appendix B: Nitsch Engineering's Sampling Protocol



Scanned with CamScanner

---

FIELD SAMPLING PROTOCOL

Table of Contents

I. Purpose..... Page 3  
II. Field Sampling Safety..... Page 3  
III. Supplies..... Page 3  
IV. Sampling..... Page 4  
V. Attachment A..... Page 5  
VI. References..... Page 5

---

## I. PURPOSE AND OBJECTIVES

The Nitsch Engineering Field Sampling Protocol document's purpose is to ensure that field sampling activities are performed consistently by sampling crews. The procedures in this document are to ensure the safety of the sampling crews and the quality of the sample. Adhering to these procedures will ensure that all samples are up to the quality that Nitsch Engineering require. This document was modeled after the United States Environmental Protection Agency's Field Sampling Quality Control, dated April 26, 2017.

The object of this sampling protocol is to obtain representative samples and maintain their integrity to ensure quality results.

## II. FIELD SAMPLING SAFETY

To ensure safety in the field, sampling crews should follow the Standard Health and Safety Practices (i.e. EPA Handbook for Sampling and Sample Preservation of Water and Wastewater, OSHA Regulations, Standards and Policies, etc.).

Remember the following items while in the field.

- 1) Remember, you are responsible for your own safety.
- 2) Do not rely on others to provide for your safety.
- 3) Never work in conditions that you feel are unsafe.
- 4) Use the buddy system
- 5) Makes sure someone knows where you are
- 6) Wear appropriate personal protective equipment (PPE) and high visibility clothing
- 7) Use traffic signs, cones, flashers, etc. when appropriate
- 8) Work in off peak traffic hours if possible
- 9) Stay alert
- 10) Find safety if weather becomes extreme

## III. SUPPLIES

Ensure that you have all supplies before going out into the field. Here is a typical list.

- 1) 1-Liter Sampling Bottles (Amber Preferred)
  - Sampling bottles should be cleaned
  - If bottle is being reused it is important to use distilled water when cleaning. The bottle should be rinsed with distilled water at least three times. \
- 2) Ice Chest
- 3) Ice
- 4) Rain Gauge
- 5) Powderless disposable Latex or Nitrile Gloves or equal

- 
- 6) Thermometer
  - 7) Water Proof Labels
  - 8) Notebook or Tablet
  - 9) Sharpie
  - 10) Appropriate Personal Protection Equipment
  - 11) Measuring Tape
  - 12) Distilled water

#### IV. SAMPLING

##### 1) Prior to Sampling

1. Ensure all proper equipment is ready
2. Team has communicated about what the goal is, type of samples needed
3. All equipment has full battery
4. Review weather report

##### 2) Arrival in the field

1. Familiarize yourself with area and ensure you have a safe area
2. Set up material and supplies
3. Take temperature of water and record weather.
4. Record amount of rain in rain gauge.

##### 3) Sampling

1. Put on clean gloves (new gloves should be used for each location.)
2. Rinse sample container with distilled water three times.
3. Fill clean sample containers as much as possible and put top on tight
4. Label sample with date, time, sample ID, and initials. (see Attachment A: Sample Sheet)
5. Place sample in ice chest

##### 4) Storage and Transport

To ensure that the sample are preserved and not contaminated, tightly sealed samples should be placed in an ice chest with a sealed back of ice. Excess water in ice chest from melting ice should be drained and ice should be as needed. It is essential that the sample be moved from the ice chest to a fridge as soon as possible. The labels

should be kept dry and not smudged during storage and transportation.

V. Attachment A: Sample Sheet

Sample ID	Date	Time	Weather	Location	Temperature	Tests					Notes
						Conductance (µS)	pH	TSS	Anions	Cations	
Example	11/2/2016	8:35 AM	Sunny 52°F	Library	10°C	X	X	X	X	X	Water was clear with little turbidity.

VI. References

United States, EPA, Science and Ecosystem Support Division, and Timothy Simpson. "Field Sampling Quality Control." *Operating Procedure*, 2017.

United States, EPA, Office of Water, and Office of Wastewater Enforcement and Compliance. "NPDES Storm Water Sampling Guidance Document." *NPDES Storm Water Sampling Guidance Document*, 1992.



## Appendix C: Sampling Procedure

### Preparation for testing

#### Materials

- Sampling bottles- cleaned
  - One 1 L bottle
  - Two 300 mL bottle
    - One sanitized for bacteria testing
- Cooler with ice
- Disposable gloves
- Thermometer
- Labels- written out beforehand
- Notebook
- Sharpie or pen
- YSI Model 85 probe

#### Before sampling

- Clean sampling bottles if used
  - Rinse out bottles three times with DI water
- Communicate goals of trip
- Equipment at full battery
- Label bottles with code to speed up process

#### In field

- Use the YSI Model 85 probe to determine water temperature, Dissolved Oxygen concentration, and specific conductance of the sampling site
  - Note weather conditions too- helps to take pictures of areas sourced
- Record amount of rain in gauge

#### Procedure for sampling

##### Standing Bodies of Water Sampling

1. Put on clean gloves- new gloves for each location
2. Use the YSI Model 85 probe to test for water temperature, DO and specific conductance
  - a. Note the units and the results
3. Uncap a 1L container, be careful not to touch the rim of the bottle, rinse it out three times with water that you are sampling
  - a. Collect and sample from different locations to not disturb sediment on the bottom
4. Collect the water - fill container as much as possible- do not touch inside of bottle or cap (do not place in pocket or on the ground)
5. Cap the bottle and note time sample was taken- write down time, date, label ID, and location of the collected sample
6. Place in cooler
7. Repeat steps 3 to 6 in the same location for two 250 mL bottles

Used Worcester airport and Stillwater river gauge in sterling MA to determine info about rain event

Sample ID	Date	Time	Weather	Location	Temp	Notes

Label code:

- Location
- Sample number
- Date of collection
- MQP group name



## Appendix D: Lab Data Sheet

Sample Code	Date	Location	Water Temp (°C)	Specific Conductance (µS)	pH	Dissolved Oxygen (mg/L)	Suspended Solids (mg/L)
LP1-00	9/16/19	Lower Pond Inflow	18.4		7.33	4.48	10.62
LP2-00	9/16/19	Lower Pond Outflow	17.2		7.13	7.85	6.91
UP1-00	9/16/19	Upper Pond Inflow	17.5	373	7.16	8.76	22.94
UP2-00	9/16/19	Upper Pond Outflow	18.4	375.2	6.61	8.65	7.32
UCL-XX	9/16/19	Upper Parking Lot	-	-	-	-	-
LCL-XX	9/16/19	Lower Parking Lot	-	-	-	-	-
STR-XX	9/16/19	Stream Inflow	-	-	-	-	-
STRO-XX	9/16/19	Stream Outflow	-	-	-	-	-
LP1-01	10/09/19	Lower Pond Inflow	14	238	7.1	5	5.40
LP2-XX	10/09/19	Lower Pond Outflow	-	-	-	-	-
UP1-01	10/09/19	Upper Pond Inflow	13.7	360	7.06	6.2	21.13
UP2-XX	10/09/19	Upper Pond Outflow	-	-	-	-	-
UCL-XX	10/09/19	Upper Parking Lot	-	-	-	-	-
LCL-XX	10/09/19	Lower Parking Lot	-	-	-	-	-
STR-01	10/09/19	Stream Inflow	11.6	82	6.74	4.65	38.51
STRO-XX	10/09/19	Stream Outflow	-	-	-	-	-
LP1-02	10/11/19	Lower Pond Inflow			7.32		37.99
LP2-XX	10/11/19	Lower Pond Outflow	-	-	-	-	-
UP1-02	10/11/19	Upper Pond Inflow			7.33		26.21
UP2-XX	10/11/19	Upper Pond Outflow	-	-	-	-	-
UCL-XX	10/11/19	Upper Parking Lot	-	-	-	-	-
LCL-XX	10/11/19	Lower Parking Lot	-	-	-	-	-
STR-02	10/11/19	Stream Inflow			7.15		1.07
STRO-XX	10/11/19	Stream Outflow	-	-	-	-	-
LP1-XX	10/27/19	Lower Pond Inflow	-	-	-	-	-
LP2-XX	10/27/19	Lower Pond Outflow	-	-	-	-	-
UP1-XX	10/27/19	Upper Pond Inflow	-	-	-	-	-
UP2-XX	10/27/19	Upper Pond Outflow	-	-	-	-	-
UCL-03	10/27/19	Upper Parking Lot	10.9	6.9	7.55	7.42	11.73
LCL-03	10/27/19	Lower Parking Lot	10.9	11	8.02	6.6	13.19
STR-03	10/27/19	Stream Inflow	12	80.7	7.27	6.05	5.99
STRO-03	10/27/19	Stream Outflow	9.8	11.2	7.3	6.6	13.36
LP1-04	11/22/19	Lower Pond Inflow	7.4	318.3		6.45	6.5
LP2-XX	11/22/19	Lower Pond Outflow	-	-	-	-	-
UP1-04	11/22/19	Upper Pond Inflow	6.2	121.4	7.41	7.75	5.333333333
UP2-XX	11/22/19	Upper Pond Outflow	-	-	-	-	-
UCL-04	11/22/19	Upper Parking Lot			7.34		31
LCL-04	11/22/19	Lower Parking Lot	7.6	13	7.82	7.21	17.333333333
STR-XX	11/22/19	Stream Inflow	-	-	-	-	-
STRO-04	11/22/19	Stream Outflow	6.8	6.2	7.26	8.11	3.833333333
ROOF-04	11/22/19	Roof Runoff			7.24		6

Sample Code	Date	Location	NH3 (mg/L)	Total Phosphorus (mg/L)	Bacteria (MPN/100ml)	
					Coliform	E. Coli
LP1-00	9/16/19	Lower Pond Inflow	0.146	0.193	-	-
LP2-00	9/16/19	Lower Pond Outflow	0.11	0.109	-	-
UP1-00	9/16/19	Upper Pond Inflow	0.16	0.298	-	-
UP2-00	9/16/19	Upper Pond Outflow	0.16	0.258	-	-
UCL-XX	9/16/19	Upper Parking Lot	-	-	-	-
LCL-XX	9/16/19	Lower Parking Lot	-	-	-	-
STR-XX	9/16/19	Stream Inflow	-	-	-	-
STRO-XX	9/16/19	Stream Outflow	-	-	-	-
LP1-01	10/09/19	Lower Pond Inflow	0.181	-	913.9	456.9
LP2-XX	10/09/19	Lower Pond Outflow	-	-	-	-
UP1-01	10/09/19	Upper Pond Inflow	-	0.075	1011.2	75.9
UP2-XX	10/09/19	Upper Pond Outflow	-	-	-	-
UCL-XX	10/09/19	Upper Parking Lot	-	-	-	-
LCL-XX	10/09/19	Lower Parking Lot	-	-	-	-
STR-01	10/09/19	Stream Inflow	0.061	0.396	1011.2	1011.2
STRO-XX	10/09/19	Stream Outflow	-	-	-	-
LP1-02	10/11/19	Lower Pond Inflow	0.181	0.093	913.9	137.6
LP2-XX	10/11/19	Lower Pond Outflow	-	-	-	-
UP1-02	10/11/19	Upper Pond Inflow	0.069	0.105	960.6	8.5
UP2-XX	10/11/19	Upper Pond Outflow	-	-	-	-
UCL-XX	10/11/19	Upper Parking Lot	-	-	-	-
LCL-XX	10/11/19	Lower Parking Lot	-	-	-	-
STR-02	10/11/19	Stream Inflow	-	0.097	1011.2	1011.2
STRO-XX	10/11/19	Stream Outflow	-	-	-	-
LP1-XX	10/27/19	Lower Pond Inflow	-	-	-	-
LP2-XX	10/27/19	Lower Pond Outflow	-	-	-	-
UP1-XX	10/27/19	Upper Pond Inflow	-	-	-	-
UP2-XX	10/27/19	Upper Pond Outflow	-	-	-	-
UCL-03	10/27/19	Upper Parking Lot	0.102	0.248	1011.2	34.1
LCL-03	10/27/19	Lower Parking Lot	0.442	0.391	1011.2	60.5
STR-03	10/27/19	Stream Inflow	0.377	0.225	1011.2	1011.2
STRO-03	10/27/19	Stream Outflow	0.49	0.29	1011.2	913.9
LP1-04	11/22/19	Lower Pond Inflow	0.159	-	228.2	6.3
LP2-XX	11/22/19	Lower Pond Outflow	-	-	-	-
UP1-04	11/22/19	Upper Pond Inflow	-	2.776	829.7	6.3
UP2-XX	11/22/19	Upper Pond Outflow	-	-	-	-
UCL-04	11/22/19	Upper Parking Lot	0.5	0.36	153.9	0
LCL-04	11/22/19	Lower Parking Lot	0.278	0.145	1011.2	8.4
STR-XX	11/22/19	Stream Inflow	-	-	-	-
STRO-04	11/22/19	Stream Outflow	-	-	601.5	209.8
ROOF-04	11/22/19	Roof Runoff	0.106	-	3	1

Location	Anions										
	Fluoride (ppb)	Chloride (ppm)	Nitrite (ppb)	Sulfate (ppm)	Bromide (ppb)	Nitrate (ppb)	Phosphate (ppb)	Mn 55 (ppb)			
59.213	88.027		12.427	63.020	20.886	8.598	-				
55.867	87.764		12.385	75.281	89.702	4.334	-				
69.695	95.852		13.935	158.705	10.297	-	-				
71.481	95.839		13.937	158.279	5.247	1.773	-				
-	-		-	-	-	-	-				
-	-		-	-	-	-	-				
-	-		-	-	-	-	-				
-	-		-	-	-	-	-				
52.148	85.117		12.081	49.214	110.731	27.767	68.30				
49.362	89.949		15.101	134.460	12.922		46.79				
-	-		-	-	-	-	-				
-	-		-	-	-	-	-				
-	-		-	-	-	-	-				
37.799	45.549		7.335	18.488	1303.144	15.207	50.22				
-	-		-	-	-	-	-				
53.571	86.147		12.421	58.346	211.020	3.765	58.28				
-	-		-	-	-	-	-				
53.317	90.808		15.491	130.851	72.630	5.984	44.17				
-	-		-	-	-	-	-				

Location	Metals													
	Mn 55 (ppb)	Cu 63 (ppb)	Pb 208 (ppb)	Na 23 (ppm)	Mg 24 (ppm)	Ca 43 (ppm)	Fe 57 (ppb)	Cr 52 (ppb)	As 75 (ppb)	Se 82 (ppb)	Ag 107 (ppb)	Cd 111 (ppb)	Ba 138 (ppb)	Total Nitrogen
er Pond Inflow	-	-	-	-	-	-	-	-	-	-	-	-	-	-
er Pond Outflow	-	-	-	-	-	-	-	-	-	-	-	-	-	-
er Pond Inflow	-	-	-	-	-	-	-	-	-	-	-	-	-	-
er Pond Outflow	-	-	-	-	-	-	-	-	-	-	-	-	-	-
er Parking Lot	-	-	-	-	-	-	-	-	-	-	-	-	-	-
er Parking Lot	-	-	-	-	-	-	-	-	-	-	-	-	-	-
Stream Inflow	-	-	-	-	-	-	-	-	-	-	-	-	-	-
Stream Outflow	-	-	-	-	-	-	-	-	-	-	-	-	-	-
er Pond Inflow	68.30	3.16	0.27	45.72	1.95	9.81	277.07	-	-	-	-	-	-	-
er Pond Outflow	-	-	-	-	-	-	-	-	-	-	-	-	-	-
er Pond Inflow	46.79	3.63	1.67	50.80	0.70	4.75	367.69	-	-	-	-	-	-	-
er Pond Outflow	-	-	-	-	-	-	-	-	-	-	-	-	-	-
er Parking Lot	-	-	-	-	-	-	-	-	-	-	-	-	-	-
er Parking Lot	-	-	-	-	-	-	-	-	-	-	-	-	-	-
Stream Inflow	50.22	1.96	0.10	25.86	0.96	5.56	51.53	-	-	-	-	-	-	-
Stream Outflow	-	-	-	-	-	-	-	-	-	-	-	-	-	-
er Pond Inflow	58.28	3.20	0.35	45.93	1.98	9.88	292.44	-	-	-	-	-	-	-
er Pond Outflow	-	-	-	-	-	-	-	-	-	-	-	-	-	-
er Pond Inflow	44.17	3.76	1.74	52.53	0.72	4.17	372.35	-	-	-	-	-	-	-
er Pond Outflow	-	-	-	-	-	-	-	-	-	-	-	-	-	-
er Parking Lot	-	-	-	-	-	-	-	-	-	-	-	-	-	-
er Parking Lot	-	-	-	-	-	-	-	-	-	-	-	-	-	-
Stream Inflow	300.71	1.76	0.13	57.37	1.84	10.02	128.94	-	-	-	-	-	-	-
Stream Outflow	-	-	-	-	-	-	-	-	-	-	-	-	-	-
er Pond Inflow	-	-	-	-	-	-	-	-	-	-	-	-	-	-
er Pond Outflow	-	-	-	-	-	-	-	-	-	-	-	-	-	-
er Pond Inflow	-	-	-	-	-	-	-	-	-	-	-	-	-	-
er Pond Outflow	-	-	-	-	-	-	-	-	-	-	-	-	-	-
er Parking Lot	176.435	1.284	-0.017	0.406	0.099	0.417	5.993	-	-	-	-	-	-	-
er Parking Lot	67.811	3.597	0.244	0.728	0.193	0.515	24.487	-	-	-	-	-	-	-
Stream Inflow	231.019	1.364	0.431	13.084	0.486	2.963	75.408	-	-	-	-	-	-	-
Stream Outflow	138.39	2.978	0.355	81.922	3.027	16.57	22.588	-	-	-	-	-	-	-
er Pond Inflow	229.383	2.141	0.23	35.561	2.074	10.258	173.077	0.207	0.16	0.109	0.035	0.051	3.592	0.852
er Pond Outflow	-	-	-	-	-	-	-	-	-	-	-	-	-	-
er Pond Inflow	96.46	2.206	0.564	22.907	0.056	3.96	59.632	0.137	1.973	0.533	0.013	0.025	31.526	1.01
er Pond Outflow	-	-	-	-	-	-	-	-	-	-	-	-	-	-
er Parking Lot	18.994	1.457	-0.007	1.681	0.232	1.042	5.644	0.173	0.226	0.215	0.029	0.016	4.726	1.54
er Parking Lot	18.351	1.537	0.308	1.419	0.103	0.324	30.523	0.0391	0.0646	0.236	0.23	0.012	5.074	0.725

## Appendix E: pH Procedure

1. Standardize the probe using 4, 7, and 10 pH buffers
  - a. Remove the probe from the storing solution and open the filling hole seal.
  - b. Rinsed the pH electrode with DI water and dried it with a Kimwipe
  - c. Place the probe in the 4 pH buffer solution
  - d. Press the “STD” button and wait for the screen to read “Stable”
  - e. Accept the new standardized value by pressing “STD” again
  - f. Remove the probe from the buffer solution
  - g. Clean and place into the next buffer
  - h. Repeat steps with other buffers
2. Clean probe and place into a 300 mL sample
3. Wait 5 to 10 minutes for probe to read as “Stable”
  - a. Note the final pH
4. Repeat steps 1 to 3 for other samples

## Appendix F: Total Phosphorus Procedure

### Total Phosphorus Procedure:

1. Clean glassware (100 mL beakers, 100 mL volumetric flasks, 25 mL volumetric flasks)
  - a. Soak in acid bath overnight, rinse 3 times with tap water, rinse 3 times with DI water
2. Label 100 mL beakers with blank, standards and sample IDs
3. Make Standards
  - a. Take out the labeled bottle of standard from the refrigerator
  - b. Get 100 mL volumetric flasks
  - c. Label flasks for standards
  - d. Pipette standard amounts according to the sheet
  - e. Fill flasks with DI water from e-pure tap, then use a spray bottle to fill the flask to the line
  - f. Add parafilm to the flasks
  - g. Invert flasks 5 times each
4. Pour blank, standards, samples into 25 mL volumetric flasks
  - a. Rinse the flasks before filling: add a little, swirl, dump out (do this twice)
  - b. Use disposable, plastic pipette if over line
  - c. Pour into corresponding beaker, rinse flask with spray bottle twice
5. Digest samples (about 1 mL of standards and samples will be left in the beakers)
  - a. Add 5 mL of nitric acid and 1 mL of sulfuric acid to each beaker
  - b. Heat on hot plate until ~1 mL left or it starts fuming
  - c. Add drops of H<sub>2</sub>O<sub>2</sub> if there are too many organics in the sample (cloudy and colored)
6. Turn on spectrophotometer
7. Make sure the spectrophotometer is on single wavelength and the wavelength is set to 400 nm (change wavelength by pressing manual program)
8. Filter samples
  - a. Use #4 filter paper, Whatman
  - b. Funnels
9. Get 3 Solutions
  - a. Phenolphthalein: 1000 mL, white/clear bottle, clear solution
  - b. Molybdovanadate: 1000 mL, white/clear bottle, yellow solution
  - c. NaOH: 6.25 N, white bottle, clear solution
10. Get supplies for each solution
  - a. 2 disposable droppers, 100 mL beaker
  - b. 1 mL pipette and tip (1-5 mL, large tips in drawer)
11. Get DI water (in squirt bottle), paper towels, gloves, “my” cell from water lab, large waste beaker
12. Transfer blank solution from beaker into cell; rinse with DI water to get all of the sample
13. Add 1 drop of Phenolphthalein
14. Add NaOH with dropper until sample turns pink
15. Add E-pure water to the line on the cell with squirt bottle
16. Add/pipette 1 mL of Molybdovanadate
17. Set spectrophotometer timer to 3 minutes

18. Place the cell in the spectrophotometer (Kim wipe first) with the white line mark facing outwards when the timer reaches 0
19. Press Zero
20. Rinse cell into large waste beaker
21. Repeat steps 12-20 for the rest of the samples and standards, except press read for step 19
22. Dispose the waste into hazardous waste bottle for total phosphorus

## Appendix G: Ammonia (NH<sub>3</sub>) Procedure

Ammonia (NH<sub>3</sub>) procedure:

1. Filter samples
  - a. Centrifuge tube
  - b. Syringes and 0.45 µm syringe filters
2. Turn on spectrophotometer (don't need to wait hours before using)
3. Make sure the spectrophotometer is set to single wavelength and the wavelength is set to 425 nm
4. Make standards
  - a. Get Nitrogen-Ammonium standard solution 100 mg/L as NH<sub>3</sub>-N from chem. Refrigerator
  - b. Get 100 mL volumetric flasks
  - c. Label flasks for standards
  - d. Pipette standard amounts according to sheet
  - e. Fill flasks with DI water from e-pure tap, then use a spray bottle to fill the flask to the line
  - f. Add parafilm to the flasks
  - g. Invert flasks 5 times each
5. Get 3 solutions from the sprinkler room
  - a. Mineral stabilizer: clear solution; small dropper bottle
  - b. Polyvinyl Alcohol Dispersing Agent (PADA): purple solution; small, dropper bottle
  - c. Nessler Reagent: yellow solution; larger bottle
6. Get supplies for each solution
  - a. 1 mL - pipette and tip (1-5 mL, large tips in drawer)
  - b. 25 mL UV-vis cell
  - c. Rubber stopper
7. Add E-pure water to 25 mL line of cell; for samples, pour from bottle (shake first), use disposable dropper for each one if filled over the line
8. Add 3 drops of Mineral Stabilizer, cap and invert several times
9. Add 3 drops of PADA, cap and invert several times
10. add/pipette 1 mL of Nessler, cap and invert several times
11. On the spec. Press timer, set to 1 minute
12. Place the cell in the machine, with the white line mark facing outwards
13. Start the timer. When the timer hits zero, press Zero
14. Rinse cell with DI water into waste beaker
15. Repeat steps 7-14 for the rest of the samples and standards, except press Read instead of Zero

Dispose of waste into Nessler Reagent hazardous waste bottle

## Appendix H: ICS Anions Procedure

### ICS Anions test - sample preparation:

1. Filter samples through 0.45  $\mu\text{m}$  syringe filter (sample should be at least 10 mL), store sample in refrigerator until analysis
2. On the test day,
  - a. Get vials, caps, marker, tool (black cylinder), plastic tray
  - b. Label vials
  - c. Use tray when filling (fill to the top of the tray, doesn't need to be exact, roughly 8 mL)
  - d. Use tool to put on caps ("hole" end first and the other end further down)
  - e. Carousel release/align, then set up the autosampler in this order:
    - i. 2 blanks
    - ii. Standards = 100, 200, 400, 800, 1200, 3000 ppb
    - iii. Samples
    - iv. 3 blanks (2 blanks and one for auto shutdown)



**Appendix I: ICPMS Metal Test Procedure:**

ICPMS metal test - sample preparation:

1. Label the 15 mL test tubes
2. Filter samples through 0.45  $\mu\text{m}$  syringe filter into 15 mL test tubes to reach the 10 mL line
3. Add 100  $\mu\text{L}$  of concentrated nitric acid ( $\text{HNO}_3$ ) to each test tube
4. Mix well
5. Store samples in refrigerator until analysis

## Appendix J: Bacteria procedure

Bacteria procedure:

1. Prepare log phase (ATCC11775) for positive control
  - a. Make 2 cultures in laminar flow hood sprayed with 50% alcohol. Flame tubes, tops, caps, and loop in between each use
    - i. Add 50 mL TSB to a labeled flask
    - ii. Autoclave
    - iii. Add one loopful of frozen stock
    - iv. Incubate at 35 °C at 100 rpm for 16-18 hours
2. Prepare Samples
  - a. Run cap and bottle neck under flame before and after water is transferred, for sterilization purposes
    - i. Remove first sample from refrigerator
    - ii. Invert bottle a few times to mix contents
    - iii. Pour 100 mL of water into dilution bottle
3. Quanti-Tray preparation
  - a. Add one colibert packet to each dilution bottle for total coliforms/E. Coli, and add one enterolert packet to each dilution bottle for enterococci
  - b. After adding colibert/enterolert, re-cap bottle and shake until no particles are left in suspension. Allow bottle to sit for 1-2 minutes for colilert/enterolert to dissolve
  - c. Slowly invert dilution bottle being careful not to create bubbles, then uncap dilution bottle
  - d. Slowly pour contents into Quanti-Tray being careful not to create bubble or turbulence
  - e. Place Quanti-Trays onto orange Quanti-Tray holder and run through Quanti-Tray sealer machine
  - f. Write the time down on the Quanti-Tray and place in incubator at 36 °C for colilert and 41 °C for enterolert
4. Reading Quanti-Trays
  - a. After 24 hours remove Quanti-Trays from incubator and read under hood
  - b. Count and record the number of yellow large and small wells (total coliform)
  - c. Turn off lights and, using a U.V. light, count and quantify the number of wells that are fluorescent (E. Coli and enterococci)
  - d. Use standard tray as a comparison
  - e. Use cross reference sheet to quantify bacteria content

## Appendix K: TSS Procedure

### TSS Procedure:

1. Set up filtration apparatus, insert a filter, and apply vacuum
  2. Wet the filter with a small volume of deionized water to seat it
  3. Shake the sample vigorously and then measure out the predetermined sample volume using a graduated cylinder. Record the volume filtered in liters on the bench sheet
  4. Rinse the graduated cylinder and filter with three 20 mL volumes of DI water, allowing complete drainage between washings
  5. Continue suction for three minutes after filtration is complete
  6. Carefully transfer the filter to an aluminum weighing dish, and place filter on a cookie sheet or similar device
  7. Place filters on sheet into an oven set to  $104 \pm 1$  °C and dry for a minimum of one hour
  8. Remove filters from oven and transfer them to a desiccator to cool in room temperature
  9. Weigh one sample filter to the nearest 0.1 mg. On the bench sheet record the sample ID and the mass (Mass 1) in the “Weight check” section.
  10. Repeat steps 7 - 9 for all samples
  11. Repeat steps 7 - 10 and record the mass as “Mass 2” in the “Weight Check” section of the bench sheet. If the mass of the filter increases less than 0.5 mg or the change in the mass of the solids is less than 4% of the previously measured mass, then continue with TSS calculations
    - a. If the mass of the filter increases by more than 0.5 mg or the change in the mass of the solids is less than 4% of the previously measured mass. Record each additional mass on the bench sheet as “Mass 3”, “Mass 4”, etc. Use the back of the bench sheet if necessary
  12. Record the Oven Dry Mass (in mg) on the bench sheet
  13. Calculate TSS
- Dump remaining sample down the drain, remove label, and rinse with tap water to remove any solids from the bottle. Wash bottles according to the bottle prep non-metals SOP 0150R01

**Appendix L: Proposal**

**Worcester Polytechnic Institute**



**WPI**

**Designing a Stormwater Management System for the  
EcoTarium**

A Major Qualifying Project Proposal  
Submitted to the Faculty of  
Worcester Polytechnic Institute

Written By

Nicholas Cumello  
Zeke Feldman  
Benjamin Rickson  
Samantha Vogel

Advised By

Paul Mathisen  
Harold Walker

Sponsored By



**10/31/2019**

## Table of Contents

### Capstone Design

Error! Bookmark not defined.

### Licensure

Error! Bookmark not defined.

### 1.0 Introduction

Error! Bookmark not defined.

### 2.0 Background

Error! Bookmark not defined.

#### 2.1 Stormwater

Error! Bookmark not defined.

#### 2.2 Stormwater Contaminants

Error! Bookmark not defined.

##### 2.2.1 Heavy Metals

Error! Bookmark not defined.

##### 2.2.2 Nutrients

Error! Bookmark not defined.

##### 2.2.3 Total Solids

Error! Bookmark not defined.

##### 2.2.4 Pathogens

Error! Bookmark not defined.

#### 2.3 Stormwater Management

Error! Bookmark not defined.

##### 2.3.1 Stormwater Regulations

Error! Bookmark not defined.

##### 2.3.2 Best Management Practices

Error! Bookmark not defined.

#### 2.4 Past Work

Error! Bookmark not defined.

#### 2.5 EcoTarium

Error! Bookmark not defined.

#### 2.6 Summary

Error! Bookmark not defined.

### 3.0 Methodology

Error! Bookmark not defined.

#### 3.1 Sampling

Error! Bookmark not defined.

#### 3.2 Laboratory Testing

Error! Bookmark not defined.

#### 3.3 Analysis

Error! Bookmark not defined.

#### 3.4 Design

Error! Bookmark not defined.

#### 3.5 Deliverables

Error! Bookmark not defined.

### References

Error! Bookmark not defined.

### Appendices

Error! Bookmark not defined.

Appendix A: Table of various BMPs, descriptions and pollutant removal efficiencies

Error!

**Bookmark not defined.**

Appendix B: Gantt Chart

Error! Bookmark not defined.

Appendix C: Sampling Procedure

Error! Bookmark not defined.

Appendix D: Total Phosphorus Procedure

Error! Bookmark not defined.

Appendix E: ICS Anions Procedure

Error! Bookmark not defined.

Appendix F: ICPMS Metal Test Procedure:

Error! Bookmark not defined.

Appendix G: Ammonia (NH<sub>3</sub>) procedure

78

Appendix H: Bacteria procedure

81

Appendix I: TSS Procedure

Error! Bookmark not defined.

Appendix J: Design Matrix for BMP Selection

Error! Bookmark not defined.



## Capstone Design

Our Major Qualifying Project (MQP) satisfies Worcester Polytechnic Institute's graduation requirement as well as the American Society of Civil Engineers' (ASCE) recommendation for an engineering design project. The requirements for this include the design of an open-ended project where the team defined the goals and criteria and for the design process to be iterative (ASCE, ABET, 2019). The design must also meet the standards set forth by local, state, and national legislative bodies. Additional criteria that our group considered were the environmental, sustainability, economic, and feasibility factors. The design for this project included all of these criteria.

The project involved the design of a system to manage the contamination in the stormwater on the EcoTarium grounds. Our team designed a stormwater management system and based our design on the criteria of sustainability, environmental factors, economics, and the feasibility of the design to be used at the EcoTarium based on space, construction time, and maintenance.

- The sustainability for this project was important in the design of the system. The goal of the project was to filter out contamination in the stormwater runoff. If the system were to ineffectively remove the contaminants from the runoff, then design would have no purpose.
- The environmental factors were also important to account for. Keeping the environment as a priority is in line with the purpose and morals of the EcoTarium as a nature museum.
- The EcoTarium was given a grant to complete this project. This grant gives our group an economic limit to the cost of the project.
- The EcoTarium wants to keep as much of its grounds untouched. The current developed land has been minimized to only what is needed to perform as a nature museum. This creates an area restriction that our group must follow.
- The time required for the system to be implemented should be limited as the environmental benefits cannot begin until the system is fully built.
- Our goal with the maintenance for the system was to not put a strain on budgets or labor for the EcoTarium. This means we wanted to design a system that would require the least amount of maintenance and when maintenance is required, it would be easy and cost-effective.

The design process for our project required multiple iterations of our design before a final design was settled on. While the stormwater runoff from the EcoTarium does not leave the site and therefore did not need to be state regulated, our team used state codes for surface water contamination to determine the site needs for contaminant filtration.



## **Licensure**

To protect the public, licensure is a practice for engineers to become certified that they are knowledgeable in their field (American Society of Civil Engineers, 2019). When licensed, a civil engineer takes on the moral and ethical responsibilities that come with the licensure. A professional engineer must be able to discern what the ethically and morally correct actions to take in a situation and act on those actions. The professional licensure is a means to ensure the safety of the public.

To obtain licensure, an engineer must first complete their education an ABET accredited engineering or engineering technology program. Then they must take and pass the fundamentals of engineering exam which can be taken during the senior year of an engineering program. Then after four years of experience, with some exceptions depending on the state, an applicant can fill out a detailed application with the work completed during those four years and references which shows the growth of the applicant in the professional field and boast to the merit of the applicant's character. At this point the applicant can then take the national Principles and Practice of Engineering exam and any state additions to the exam. Once passed the applicant will be licensed as a Professional Engineer in that state (American Society of Civil Engineers, 2019).

## 1.0 Introduction

Stormwater is water that originates from rain or snowmelt events and either flows into streams and other water bodies, evaporates, infiltrates into the soil, or is transpired by plants. In an urban setting, less of the water is able to infiltrate the soil due to more impervious surfaces and instead is left to run into water bodies. Because of the lack of infiltration and the more polluted nature of an urban area, the runoff contains higher concentrations of contaminants than non-urban stormwater (Environmental Protection Agency, 2019). The type of surface over which the water is flowing influences the type of contaminants found in the runoff, as found by a previous WPI study (O’Leary, Stanway, Acaba, Balcewicz, and Adams, 2019).

Without proper treatment, stormwater can carry contaminants into bodies of water including streams, ponds and aquifers. The polluted water can affect the wildlife in the area. Studies of otters that were exposed to a contaminated river, where stormwater was discharged, found that otters can get bacterial infections due fecal matter collected in the stormwater (Aguirre, Daszak, and Ostfeld, 2012; McBride, Conrad, and Smith, 2016). When runoff from agricultural land or lawns enters water ecosystems, the nutrients from that runoff causes eutrophication, where the ecosystem is suffocated by an excess of algae that grows because of the nutrients. To lessen the number of contaminants in runoff, Best Management Practices (BMPs) are used. These are measures taken to reduce the effect of stormwater runoff to either reduce flow and/or remove contaminants from the water. They are important to mitigate the effect that pollution has on stormwater.

The EcoTarium, a nature and science education museum in Worcester MA, is concerned about the contaminants collected by stormwater entering their on-site ponds. Contaminants such as fecal matter are picked up when stormwater runs through the animal exhibits, pathways, and parking lots. These contaminants are then transported across the grounds and deposited into the ponds. The EcoTarium would like to improve their current stormwater management practices to better reduce the contaminants in the stormwater on their site. The current stormwater management system is unable to fully filter the contaminants in the on-site stormwater runoff. This means that, in its current state, the EcoTarium cannot effectively treat the stormwater runoff going into its ponds.

The goal of this project is to quantify contaminants in the stormwater runoff on the EcoTarium campus and to make a preliminary design for an on-site stormwater management system. While the EcoTarium has no legal obligations to filter their stormwater, as the on-site stormwater does not flow into the city’s infrastructure, being a nature museum the EcoTarium both wants to keep their site clean of contamination and also wants to be able to educate the public about stormwater management and its importance. Our project samples and tests the water found at the EcoTarium and analyzes that data. Then a design is tailored to the needs of the EcoTarium based on what contaminants are found in the samples.

## 2.0 Background

The following sections will outline the background information needed for our report. Information about stormwater and common stormwater contaminants that are later analyzed in this study begin this section. State regulations for water quality and the methods for analyzing them follow. Finally, previous work related to the project and information about the location that this project is taking place, the EcoTarium, are discussed.

### 2.1 Stormwater

Stormwater is any type of water that originates from a precipitation event. Precipitation events include rain, snow, or hail. The main landscapes that affect the stormwater in this study include undeveloped, urban, and agricultural areas. When stormwater accumulates on a natural surface it is more likely to infiltrate into the ground than in urban areas. In the natural system, water percolates through the soil. The plants and denser soils act as natural filters for the runoff, removing collected contaminants. Eventually the water infiltrates the ground and replenishes the water table. The rate at which soil can do this is called the soil's infiltration capacity. When rainwater lands on impervious surfaces, which includes roads, sidewalks, rooftops, and parking lots, the stormwater flows across them accumulating different pollutants and transporting them into nearby waterways. This pollution of stormwater is deemed non-point source pollution, which is when the runoff collects pollutants from many different sources that cannot be pinpointed to a given location. When stormwater accumulates on impervious surfaces, the pollutants and water are not able to infiltrate the ground and be naturally filtered by the soil and vegetation (Ho Lee, 2000)

Common pollutants found in stormwater include heavy metals, nutrients, bacteria, and total solids. Many of these pollutants can cause environmental damage. These contaminants come from sources such as lawn fertilizer, automotive fluids, and litter. There are many ways to manage the stormwater as an effort to try and reduce contaminated runoff entering waterways. Different management practices such as water basins, filters, wells, and porous pavements can be uniquely beneficial to different areas to help mitigate contaminants from entering the water systems (Vassilios, 1997).

### 2.2 Stormwater Contaminants

There are many different types of contaminants in stormwater that can be transported into bodies of water, where they can cause adverse environmental and health effects. This section outlines the types of contaminants commonly found in stormwater as well as their respective negative health and environmental impacts shown in Table 1.

**Table 1:** A list of different stormwater runoff contaminants, their sources, and the impacts they have.

Contaminant	Sources	Impacts
-------------	---------	---------

Heavy Metals	- Roadways	- Inhibited gill functions of fish - Toxic to humans
Nutrients	- Fertilizer - Agricultural land	- Algae/Cytobacterium Blooms - Eutrophication
Total Solids	- Runoff - Soil Erosion	- Eutrophication - Increase in turbidity
Pathogens	- Fecal matter	- Health risk to animals that live in the water or use it as a drinking source

**2.2.1 Heavy Metals**

Heavy metals are one of many different contaminants that contribute to stormwater pollution. Heavy metals of particular concern in stormwater are zinc, lead, copper, mercury, and nickel. Major sources of heavy metals in stormwater runoff include roads, construction-sites, and soil erosion. On roads, vehicle exhaust residue and brake pads have been identified as contributors to heavy metal contamination. (Adamiec, Jarosz--Krzemińska, and Wieszala, 2016). Heavy metal contamination of water bodies can lead to environmental impacts, such as copper inhibiting the respiratory system of fish or nickel and zinc severely damaging their gill functions (Brooks Applied Labs, 2016). Heavy metals are also highly toxic to humans; lead specifically has been found to put children at risk of major developmental problems (Environmental Protection Agency, 2019).

**2.2.2 Nutrients**

Nutrients such as nitrogen and phosphorus are necessary for plant life to grow. These nutrients are often found in the runoff from lawns and agricultural land due to fertilizer use (Reddy, 2014). Fertilizer can negatively impact ponds or other water ecosystems that it enters due to stormwater runoff. When exposed to high levels of nitrogen or phosphorus, water ecosystems are faced with algae or cyanobacteria blooms (Figure 1), where the algae or cyanobacteria blooms to a point where they suffocate the ecosystem (Reddy, 2014; Evanylo et al., 2008; Conley, 2009). This process is called eutrophication. In eutrophication, when the bloom removes the other nutrients and blocks sunlight from the water which causes other organisms in the ecosystem to die. The dead organisms then release more nitrogen and phosphorus continuing the cycle.



**Figure 1:** An algae bloom in a small pond (“*Algae bloom in small farm pond*”, 2007).

### 2.2.3 Total Solids

Total solids include dissolved solids, suspended solids, and settleable solids in water. Solids are made up of both inorganic and organic material. Total dissolved solids (TDS) consist of calcium, chlorides, nitrate, phosphorus, iron and other ions that can pass through a filter with pores around two microns in size. Suspended solids (SS) are particles larger than two microns that stay suspended in water. Examples of these are soils, metals, clay, plankton, algae, and other debris which enter water systems from stream banks, construction-sites, and from impervious pavements. There are many negative impacts on the water quality from having high concentrations of solids in the water systems which can affect the organisms living in the water. For example, suspended solids can serve as carriers of toxins, which cling to the particles and use the particles as a transportation mechanism. High concentrations of suspended solids will also lead to an increase in the turbidity of the water. A high turbidity affects water temperatures because suspended particles absorb and scatter sunlight. Sedimentation of these particles can also affect the habitats of bottom dwelling organisms (Environmental Protection Agency, 2019).

### 2.2.4 Pathogens

Pathogens are bacteria, viruses, and other microorganisms that can cause disease. There are many different pathogens that are expensive and inefficient to test for in water. Instead, determining the presence of other microorganisms is more beneficial (Oram, 2019; Wu, Long, and Dorner, 2011).

Bacteria can be found as a contaminant in stormwater runoff. It mainly originates from animal waste. It is picked up from lawns and streets during rain events and carried into water bodies. Rooftops and parking lots are usually low contributors to bacteria concentrations. The presence of bacteria in water can indicate the possibility of fecal contamination. This is usually a concern because fecal matter in water is a health risk. In a study conducted in 2011, *E. coli* and enterococci have been linked to indicating fecal matter contamination (Minnesota Stormwater Manual, 2018). It is dangerous for humans to swim in water when *E. coli* is present. Low

concentrations of the bacteria in water can be present for humans to use recreationally. However, if animals use the body of water as a drinking source, *E. coli* should not be present (Swistock, 2015). Coliform bacteria are also a good indicator of the presence of pathogens in water. This bacterium originates from the intestinal tract of warm-blooded animals. The presence of this bacteria also indicates fecal contamination (Oram, 2019).

## **2.3 Stormwater Management**

Stormwater management is an essential part of mitigating the negative effects of stormwater runoff and contaminants on the environment. Mismanagement of stormwater can lead to flooding, erosion, and water pollution (Adams, 2000). The application of stormwater management is very evident in many different land uses including, urban areas, agricultural drainage, flood control, water supply, and forest management. Standards for stormwater management are put into place by stormwater regulations, which establish a minimum level of treatment for stormwater. The water quality can be improved using Best Management Practices (BMPs) by mitigating the contaminants that enter the waterways. The effective use of BMPs takes into account the quality and quantity of stormwater entering and leaving the system.

### **2.3.1 Stormwater Regulations**

In order to protect natural resources such as lakes, rivers, and coastal areas from potential damage, the Environmental Protection Agency (EPA) put the National Pollutant Discharge Elimination System (NPDES) into place in 1972. In order for any source to be able to legally discharge into a water body, a NPDES permit must first be obtained by the owner of the source. These permits address the problem of water pollution in two different ways. First, there are technology-based effluent limitations which require all water discharged from a site to undergo a minimum amount of treatment. The other method of controlling water quality of discharge is Water Quality-Based Effluent Limitations (WQBELs), which establishes Total Maximum Daily Loads (TMDLs) for specific pollutants. These specify an amount of a pollutant or property of a pollutant that can be safely discharged into a water body and still ensure the quality of said water. The EPA sets minimum TMDLs for many different pollutants, but states can have more restrictive TMDL regulations (Environmental Protection Agency, 2019).

While the NPDES sets in place very specific regulations for any sites releasing pollutants as point source pollution, where pollution originates from a single source, it is much harder to regulate non-point source pollution, such as stormwater pollution. This is because non-point source pollution is not released from a site in a stream, instead being the collected contaminants picked up in water flow traveling through the site. Because of the difficulty in regulating stormwater pollution, the EPA only requires stormwater discharge permits from sites most at risk to causing stormwater pollution, such as construction-sites and industrial facilities. Stormwater runoff from municipalities and roads are also regulated, although the way in which they are regulated is different from how regulation was previously discussed. Stormwater pollution from these sources are regulated by Municipal Separate Storm Sewer Systems (MS4s), in which stormwater is collected and is eventually discharged into a local water body. Rather than these systems being owned directly by the EPA, they are owned by the town, city, or region that uses them. MS4s are required to be deployed alongside Stormwater Management Programs (SWMPs), which outline stormwater control practices that will be enacted by the MS4

community in order to minimize the amount of pollutants discharged from the MS4 system. It is important to stress that these systems solely handle stormwater, and that they are not part of a wastewater treatment system, such as a traditional sewer. (Environmental Protection Agency, 2019).

Massachusetts’ major stormwater regulations are summarized in the Stormwater Management Standards section of the Massachusetts Stormwater Handbook, all of which are listed in Table 2. Simpler regulations, like that untreated stormwater cannot be discharged onto public land or that illicit discharges to the stormwater management system are prohibited, are stated outright in this section. More complex regulations, such as discharge to certain areas require different levels of treatment or construction are outlined in this section with further details found later in the document. The one specific stormwater treatment requirement that always applies is that 80% of total suspended solids must be removed through treatment. (Massachusetts Department of Environmental Protection, 2008).

**Table 2:** Massachusetts Stormwater Management Standards (Massachusetts Department of Environmental Protection, 2008).

Number	Regulation
1	Untreated Stormwater may not be discharged directly or to cause erosion in wetlands/public bodies of water
2	Stormwater management systems may not have peak discharge that exceeds the pre-development peak discharge
3	Loss of annual recharge to groundwater must be eliminated through the design of the stormwater management system
4	Stormwater management systems shall be designed to remove 80% of TSS
5	Land uses with higher potential pollutant loads must have source control and pollution prevention systems implemented in the stormwater management system.
6	Stormwater discharges within the Zone II or Interim Wellhead Protection Area of a public water supply, and stormwater discharges at/near any other critical are must have source control and pollution prevention systems implemented into the stormwater management system
7	Redevelopment projects are required to meet Stormwater Management Standards 2, 3, 4, 5, and 6 to the maximum extent practicable. Existing stormwater discharges must comply with Stormwater Management Standard 1 to the maximum extent practicable.
8	A plan to limit any construction related stormwater impacts (erosion, sedimentation, pollutant discharge) must be developed and implemented
9	A long-term operation/maintenance plan must be developed and implemented for

	any stormwater management system
10	All illicit discharges to stormwater management system are prohibited

### 2.3.2 Best Management Practices

Best Management Practices (BMPs) are measures taken to reduce the amount of pollution collected in stormwater runoff. Their goal is to prevent pollution in runoff from contaminating nearby bodies of water. There are three type-based categories of BMPs: point BMPs, Linear BMPs, and Area BMPs. Point BMPs focus on collecting pollutants from point sources. This practice captures water from upstream drainage at a specific location. Point BMPs are usually a combination of designs to manage flow and remove pollutants. Linear BMPs are ones that are narrow and lie adjacent to streams to filter for pollutants before they reach the water. They also help with nutrient uptake and add an aesthetic value. Area BMPs are management practices that are land-based. They take the place of impervious surfaces and lessen pollution input (Environmental Protection Agency, 2019). Examples of each category can be found in Table 3 below.

**Table 3:** List of type based BMPs and examples of each.

Point BMP	Linear BMP	Area BMP
Constructed Wetland Infiltration Basin Bioretention Sand Filter (surface) Rain Barrel Cistern Wet Pond Dry Pond	Grassed Swale Infiltration Trench Vegetated Filter Strip Sand Filter (non-surface)	Green Roof Porous Pavement

Each BMP can remove different contaminants with different efficiencies. When creating a system, the removal efficiencies need to be taken into consideration. Details of various BMPs and their removing efficiencies are outlined in Appendix A.



## 2.4 Past Work

Nitsch Engineering has worked on a study with the University of Virginia to revamp the west side of the university's stormwater system and implement BMPs. The project worked with both students and staff of the university. Nitsch implemented green BMPs such as wetlands and streambank restoration to filter and manage stormwater on the site. Three green BMPs were implemented which were able to effectively filter the area's stormwater instead of requiring different stormwater systems at different locations (Nitsch Engineering, 2019).

In the 2018-2019 academic year, Nitsch Engineering worked with WPI to sponsor an MQP team that would run tests on the stormwater on WPI's campus to determine contaminants in the runoff of different surfaces found around WPI. The MQP team tested runoff that flowed into Salisbury Pond. The team tested several different surfaces that runoff flowed over for contamination including:

- Parking Lot
- Light Road
- Heavy Road
- Walkway
- Green Roof
- Grey Roof
- Grassy Hill
- Salisbury Pond

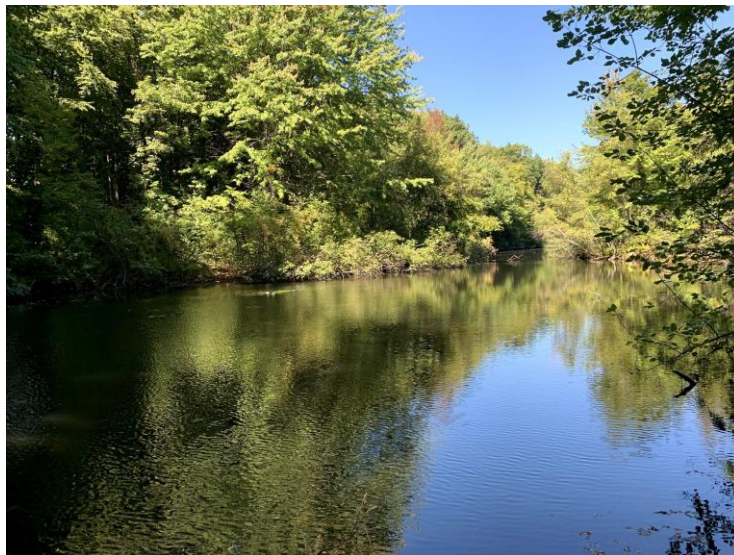
It was found that the walkway, light road, and grass area all had high levels of sodium and chloride contamination. The team also found that TSS concentrations were highest on the walkway and grassy hill while total phosphorus was highest on the heavy road and the grassy hill (O'leary, Stanway, Acaba, Balewicz, Adams, 2019). These results proved that the levels and types of contamination are dependent on the surface that the runoff flows over.

## 2.5 EcoTarium

Nitsch Engineering is now working with WPI to sponsor our MQP team to sample stormwater at the EcoTarium. The EcoTarium is a nature and science museum located in Worcester, MA. The EcoTarium originally opened in 1825 under the name of the Worcester Lyceum of Natural History, changing names and locations over the years until 1998, when the museum was renamed to the EcoTarium. At the same time, the museum began an \$18 million expansion and renovation program, which has helped bring the EcoTarium to what it is today. Since its inception, the EcoTarium has been dedicated to instill an interest in science and nature in its visitors. It does this through a variety of informational exhibits and activities both inside the EcoTarium as well as outside located around the EcoTarium's 45-acre campus, a map of which is shown in Figure 2. Particular areas of concern are the two ponds (Figure 3), the stream (Figure 4), the parking lots (Figure 5), and the roadway leading into the EcoTarium (EcoTarium, 2019).



**Figure 2:** EcoTarium Site Map (Worcester EcoTarium Map, 2015)



**Figure 3:** EcoTarium's Lower Pond





**Figure 4:** Stormwater stream bed at the EcoTarium



**Figure 5:** Storm drain at the EcoTarium

The EcoTarium is not required to have an on-site stormwater management system. This is due to the fact that EPA regulations only require an on-site management system for construction-sites and industrial facilities, and the EcoTarium falls into neither of these categories. However, the EcoTarium currently has a stormwater management system, both a system of storm drains leading from the parking lots and a sitting detention pond. However, this system does not meet their own standards for treatment. There are two major reasons that the EcoTarium tasked Nitsch Engineering to design a BMP system for their site. First, the EcoTarium is concerned with the water quality of its two on-site ponds. These ponds serve as the drainage point for both the stormwater runoff from the EcoTarium and for the surrounding area. This means that some stormwater control measures are necessary to maintain the water quality of these ponds. Second, the EcoTarium can use the stormwater control system as another exhibit for guests, educating them about stormwater pollution and how it is prevented and controlled.

## 2.6 Summary

The EcoTarium wanted to know what contaminants were in their stormwater so they could design an additional stormwater management system accordingly. As proven by prior work, to test for contamination in the runoff at the EcoTarium, a more targeted approach to testing where we test specific areas to see the difference in their levels of contamination is necessary. This allows for more targeted BMPs to be implemented on the site.

### **3.0 Methodology**

Our project involves a collaboration with Nitsch Engineering, Inc. to analyze and test stormwater runoff at the EcoTarium in Worcester Massachusetts and to design a stormwater management system. We will analyze the stormwater for different contaminants at various locations before the water enters the two on-site ponds. We will then design and use BMP's to create the most cost-effective solutions for the stormwater remediation. We will achieve this goal through the following objectives:

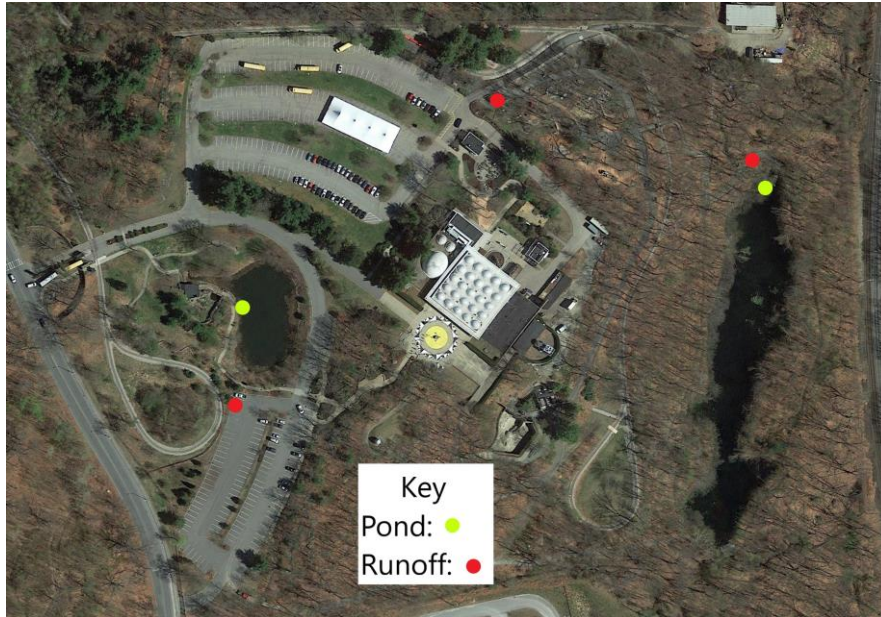
1. Collect and sample water from two on-site ponds and stormwater runoff from a range of land surface types multiple times during precipitation events.
2. Conduct laboratory analyses for various contaminants in the pond water and stormwater.
3. Analyze the contaminant data to understand the impacts of surface characteristics on water quality.
4. Design multiple stormwater solutions to reduce or remove contaminants from the stormwater.

Through following the objectives detailed in the preceding section we will be able to analyze the data collected to draw upon a conclusion and use the best BMPs to help mitigate the contaminants in the stormwater and ponds at the EcoTarium. The project schedule can be found in Appendix B.

### **3.1 Sampling**

We based our protocols off of the EPA's and Nitsch Engineering's sampling protocols (Coleman Horsley, personal communication, 2019) To ensure proper quality assurance and quality control (QA/QC) for sampling we added necessary steps in the procedures to ensure consistent standards. Before sampling events, the bottles were washed with DI water and left to dry in the lab. Bacteria samples are sanitized using a Sterilmatic. For each site location we collected multiple samples: two 300mL and a liter sample bottle. on-site, each bottle was rinsed three times in the sampling water before actual samples were taken. We rinsed the bottles in a nearby location to where the final samples were taken in order to not disturb the sediment when dumping the water back into the site. Originally, we planned to collect a dissolved oxygen (DO) water sample with a 300ml glass DO bottle but then we obtained a YSI Model 85 probe that can collect the data on-site.

We collected samples from multiple locations around the EcoTarium. We compared the concentration of contaminants in the two on-site ponds before and after rain events. This will give us an idea of the concentrations of contaminants flowing into the ponds when compared to the change in the pond depths. To test for the concentrations of contaminants entering the bodies of water, we collected samples from various locations around the ponds where flows were present. We will add a roof runoff site when there is a large enough rain event.



**Figure 6:** Sampling sites around the EcoTarium, green dots for pond water collection-sites and red dots for runoff collection-sites (Google Maps, 2019)

We tested for temperature, DO and specific conductance on-site using a YSI Model 85 probe. As soon as we got back to the lab, we tested for pH using a pH probe. After field sampling, the concentrations of various pollutants were calculated using different laboratory experiments. The samples will be tested for concentrations of metals, nutrients, solids, and pathogens by conducting analyses in the lab.

### 3.2 Laboratory Testing

The lab analyses that were performed on the water samples to determine the contaminants present are listed below:

- Spectrophotometry for ammonia and total phosphorus
- An Ion Chromatography Spectrometry (ICS) anions test for fluoride, chloride, nitrite, sulfate, bromide, nitrate, and phosphate
- An Inductively Conducted Plasma Mass Spectrometry (ICPMS) metal test for manganese, copper, lead, sodium, magnesium, calcium, and iron
- A bacteria Quanti-Tray procedure to test for E. Coli and coliform
- A total suspended solids (TSS) filtration test

Test procedures are outlined in Appendixes C-I. Each of the tests will identify different contaminants in the collected samples. To ensure QA/QC, only one person will conduct an entire experiment rather than multiple people working on the same procedure. This minimizes the variation of human error while collecting data. Multiple rain events will be sampled to ensure that the data is accurate for the general trends and not an outlier due to either problems in testing or in sampling. The results from the lab analysis will influence which BMPs are suggested in the design portion of the project.

### **3.3 Analysis**

After testing the data, our group will create a data sheet listing all of the contaminants tested for in the samples and which rain event they were collected. We will then use this data to analyze which contaminants are more prominent in the water samples and if those contaminants are concentrated in certain sampling location(s). The contaminants will be compared to the Surface Water Quality Standards, descriptions of the desired condition of a water body enforced by the EPA (Environmental Protection Agency, 2010) to determine which contaminants are too heavily concentrated in the EcoTarium's pond and stormwater. Using the results from the laboratory analysis, we can determine the best combination of BMPs to use. Individual BMPs are able to remove certain percentages of contaminants from stormwater. Using a combination of BMPs we can add the percentages of contaminant removal until the concentrations of the contaminants are below the levels found in the Surface Water Quality Standards.

Using the area usages and the soil types, found using MassGIS data, we can calculate the amount of runoff that will come from a rainstorm. Once the stormwater flow pathways have been identified, HydroCAD will be used to obtain the peak flows and volumes of the different stormwater flows. Using the peak flows and the contaminant concentrations found from laboratory testing, the total contaminant loading into the ponds can be found. Once the total contaminant loads flowing into the ponds are known, a much more effective design can be implemented in order to properly treat the stormwater runoff on-site.

### **3.4 Design**

Using the data from our team's testing and analysis, we can conclude which contaminants an implemented system will treat for. This analysis will also be used to identify the area in which the BMP will be implemented depending on where on-site stormwater contamination needs to be addressed. We will then outline a few stormwater management designs that can successfully treat the contaminants in the EcoTarium's stormwater. The different BMPs can be found in Appendix A. This table shows the different BMPs and their abilities to filter out the different contaminants. The BMPs will be narrowed down based on their ability to filter the needed contaminants. The BMPs will then be judged using the decision matrix found in Appendix J to select a final design. The design will take into account the cost, the amount of land that would be needed, time needed for construction, the necessity for maintenance and upkeep, sustainability, and environmental aspects. Multiple BMPs will be chosen that can treat for the contaminants in the system. One system will be chosen and designed based upon the criteria identified. The system will then be modeled and analyzed for effective stormwater management.

Secondary designs will be suggested that will maximize different efficiencies of concern. A monetarily efficient design and a space efficient design will be presented alongside the final design to give the EcoTarium options to choose from.

### **3.5 Deliverables**

The first deliverable to the EcoTarium and Nitsch Engineering is this report. This report shows that sufficient research has been done to ensure our quality of work. The background section is to prove that our group has the knowledge required to complete this project. The methodology section shows our group's procedure in sampling and testing. The procedure ensures the quality of the data. During the data analysis, the data will be checked to ensure consistency in the trends. The discussion section explains any decisions made by our group and the reasoning behind those choices.

The next deliverable is a presentation of our three proposed BMP designs. The designs will be presented using data, showing their abilities to remove contaminants as well as their costs and required areas. Descriptions of the required maintenance, sustainability, as well as other benefits and detriments to the designs will be presented. The design that is preferred by the EcoTarium will be further detailed by construction plans and a HydroCAD analysis that will also be submitted.



## References

- Adamiec, E., Jarosz-Krzemińska, E., & Wieszała, R. (2016). Heavy metals from non-exhaust vehicle emissions in urban and motorway road dusts. *Environmental Monitoring and Assessment*, 188(6), 1-11. doi:10.1007/s10661-016-5377-1
- Adams, B. J. (2000). *Urban stormwater management planning with analytical probabilistic models*. United States: Retrieved from
- Adell, A. D., McBride, G., Wuertz, S., Conrad, P. A., & Smith, W. A. (2016). Comparison of human and southern sea otter (*Enhydra lutris nereis*) health risks for infection with protozoa in nearshore waters. *Water Research*, 104, 220-230. doi:10.1016/j.watres.2016.08.004
- Aguirre, A. A., Daszak, P., & Ostfeld, R. (2012). *New directions in conservation medicine*. US: Oxford University Press.
- Algae bloom in small farm pond* (2007). .  
<https://www.flickr.com/photos/soilscience/5084241721>
- American Society of Civil Engineers. *Guidance on licensing and ethical responsibilities for civil engineers*
- American Society of Civil Engineers. (2019a). *Accreditation and ABET*
- American Society of Civil Engineers. (2019b). Getting licensed and certified.
- Brooks Applied Labs. (2016). *Advanced analytical services for the determination of heavy metals in stormwater* Brooks Applied Labs, LLC.
- Conley, D. J., & Paerl, H. W. (2009). Controlling eutrophication: Nitrogen and phosphorous. *Science*, 323(5917), 1014-1015. Retrieved from
- (2009-2018). Decision matrix analysis. Retrieved from  
<https://expertprogrammanagement.com/2017/09/decision-matrix-analysis/>
- EcoTarium museum of science and nature Retrieved from <https://ecotarium.org/about-us/history/>
- Environmental Protection Agency. Best management practices (BMPs) siting tool. Retrieved from <https://www.epa.gov/water-research/best-management-practices-bmps-siting-tool>
- Environmental Protection Agency. (2009). *Industrial stormwater monitoring and sampling guide*. (). Retrieved from  
[https://www3.epa.gov/npdes/pubs/msgp\\_monitoring\\_guide.pdf](https://www3.epa.gov/npdes/pubs/msgp_monitoring_guide.pdf)

- Environmental Protection Agency. (2019a). 5.8 total solids.
- Environmental Protection Agency. (2019b). Learn about lead.
- Gorman Richardson Lewis Architects. *Worcester EcoTarium map*.  
<http://www.keywordbasket.com/d29yY2VzdGVyIGVjb3Rhcml1bSBtYXA/>:
- Ho lee, J., & Woong Bang, K. (2000). Characterization of urban stormwater runoff. *Water Research*, 34(6), 1773-1780. Retrieved from J. Wu, & Long, S. C. (2011). Are microbial indicators and pathogens correlated? A statistical analysis of 40 years of research. *Journal of Water and Health*, 9(2), 265-278.
- Keeghan M. O'Leary, Kimberly Yvonne Stanway, Lucas Alexander Acaba, Stephen A. Balcewicz, & Virginia Leigh Adams. (2019). *Quantifying the pollutant removal effectiveness of best management practices in urban watersheds* ().
- Krishna R. Reddy, Tao Xie, & Sara Dastgheibi. (2014). Nutrients removal from urban stormwater by different filter materials. *Water, Air, & Soil Pollution*
- Massachusetts Department of Environmental Protection. *Structural BMP specifications for the massachusetts stormwater handbook* (Volume 2 ed.)
- Massachusetts Department of Environmental Protection. (2008). Massachusetts stormwater handbook and stormwater standards
- Minnesota Pollution Control Agency. (2018). *Bacteria in stormwater*
- National pollutant discharge elimination system (NPDES): Applications and program updates*. (2019). (). Washington: Federal Information & News Dispatch, Inc. Retrieved from Research Library Prep
- Oram, B. Bacteria, protozoans, viruses and nuisance bacteria need for water testing. Retrieved from <https://water-research.net/index.php/bacteria>
- Stormwater research at UVA. (2019).
- Minnesota Stormwater Manual. (2018). Bacteria in stormwater. Retrieved from [https://stormwater.pca.state.mn.us/index.php?title=Bacteria\\_in\\_stormwater](https://stormwater.pca.state.mn.us/index.php?title=Bacteria_in_stormwater)
- Swistock, B. (2015). Water quality concerns for ponds. *PennState Extension*
- VASSILIOS A. TSIHRINTZIS, & RIZWAN HAMID. (1997). Modeling and management of urban stormwater runoff quality: A review. *Water Resources Management*, 11(2), 136-164.

Wu, J., Long, S. C., Das, D., & Dorner, S. M. (2011). Are microbial indicators and pathogens correlated? A statistical analysis of 40 years of research. *Journal of Water and Health*, 9(2), 265-278. doi:10.2166/wh.2011.117

## Appendices

**Appendix A: Table of various BMPs, descriptions and pollutant removal efficiencies**

BMP Category	BMP Name	Description	Pollutant Removal Efficiencies
Structural Pretreatment BMPs	Deep Sump Catch Basin	<ul style="list-style-type: none"> <li>- Underground retention systems meant to remove trash, debris, and coarse sediment from runoff</li> <li>- Also act as temporary spill containment devices</li> </ul>	<ul style="list-style-type: none"> <li>- TSS- 25% if pretreatment and designed as offline system</li> </ul>
	Oil/Grit Separators	<ul style="list-style-type: none"> <li>- Underground storage tanks with chambers meant to remove heavy particulates, floating debris and hydrocarbons</li> </ul>	<ul style="list-style-type: none"> <li>- TSS- 25% if pretreatment and placed offline</li> </ul>
	Proprietary Separators	<ul style="list-style-type: none"> <li>- Flow-through structure that has a settling/separation unit to remove sediment and other pollutants</li> </ul>	<ul style="list-style-type: none"> <li>- TSS- varies, must be used for pretreatment and be placed first in treatment train</li> </ul>
	Sediment Forebays	<ul style="list-style-type: none"> <li>- An excavated pit, bermed area, or cast structure paired with a weir to slow stormwater runoff and help with the separation of suspended solids</li> <li>- Different from sediment trap</li> </ul>	<ul style="list-style-type: none"> <li>- TSS- 25%</li> </ul>
	Vegetated Filter Strips	<ul style="list-style-type: none"> <li>- Grass buffer strips, uniformly graded vegetated surfaces</li> </ul>	<ul style="list-style-type: none"> <li>- TSS-</li> <li>- if <math>25' \leq \text{wide} &gt; 50'</math> 10%</li> <li>- If <math>50' \leq \text{wide}</math> 45%</li> </ul>
Treatment BMPs	Bioretention Areas and Rain Gardens	<ul style="list-style-type: none"> <li>- Soils, plants, and microbes treat stormwater</li> </ul>	<ul style="list-style-type: none"> <li>- TSS- 90% with vegetated filter strip or equivalent</li> <li>- Total Nitrogen- 30-50% if soli media is at least 30''</li> </ul>

			<ul style="list-style-type: none"> <li>- Total Phosphorus- 30-90%</li> <li>- Metals- 40-90%</li> </ul>
	Construction Stormwater Wetlands	<ul style="list-style-type: none"> <li>- Man-made wetlands that temporary hold stormwater</li> </ul>	<ul style="list-style-type: none"> <li>- TSS - 80% when combined with sediment forebay for pretreatment</li> <li>- Total Nitrogen- 20-55%</li> <li>- Total Phosphorus- 40-60%</li> <li>- Metals 20-85%</li> <li>- Pathogens- up to 5%</li> </ul>
	Extended Dry Detention Basins	<ul style="list-style-type: none"> <li>- Modified conventional dry detention basins meant to hold stormwater for 24+ hours</li> </ul>	<ul style="list-style-type: none"> <li>- TSS- 50% when combined with sediment forebay</li> <li>- Total Nitrogen- 15-50%</li> <li>- Total Phosphorus- 10-30%</li> <li>- Metals- 30-50%</li> <li>- Pathogens- &lt;10%</li> </ul>
	Proprietary Media Filters	<ul style="list-style-type: none"> <li>- Two-chamber underground concrete vaults</li> </ul>	<ul style="list-style-type: none"> <li>- TSS- variable, depends on media</li> <li>- Total Nitrogen- variable, depends on media</li> <li>- Total Phosphorus- variable, depends on media</li> <li>- Metals- variable, depends on media</li> </ul>
	Sand and Organic Filters	<ul style="list-style-type: none"> <li>- Self-contained beds of sand either underlaid with perforated underdrain or designed with cells and baffles with inlets/outlets</li> </ul>	<ul style="list-style-type: none"> <li>- TSS- 80% with one or more pretreatment BMPs</li> <li>- Total Nitrogen- 20-40%</li> <li>- Total Phosphorus- 10-5-%</li> <li>- Metals- 50-90%</li> </ul>
	Wet Basins	<ul style="list-style-type: none"> <li>- Permanent pool of water</li> <li>- Sediments settle at bottom</li> </ul>	<ul style="list-style-type: none"> <li>- TSS- 80% with sediment forebay</li> </ul>

			<ul style="list-style-type: none"> <li>- Total Nitrogen- 10-50%</li> <li>- Total Phosphorus- 30-50%</li> <li>- Metals- 30-75%</li> <li>- Pathogens- 40-90%</li> </ul>
Conveyance BMPs	Drainage Channels	- Traditional vegetated open channels	- None
	Grassed Channel	- Grassed channels with long hydraulic residence time	<ul style="list-style-type: none"> <li>- TSS- 50% with pretreatment</li> <li>- Total Phosphorus- 121%*</li> </ul> <p style="text-align: right; margin-right: 20px;">*adds TP to system</p>
	Water Quality Swale	<ul style="list-style-type: none"> <li>- Vegetated open channels</li> <li>- Dry and Wet Swales</li> </ul>	<ul style="list-style-type: none"> <li>- TSS- 70% (dry) and 50% (wet) with pretreatment</li> <li>- Total Nitrogen- 10-90%</li> <li>- Total Phosphorus- 20-90%</li> </ul>
Infiltration BMPs	Dry Wells	- Small pits that collect runoff	- TSS- 80% from non-metal roofs
	Infiltration Basins	- Impoundments that are constructed over permeable soils	<ul style="list-style-type: none"> <li>- TSS- 80% with pretreatment</li> <li>- Total Nitrogen- 50-60%</li> <li>- Total Phosphorus- 60-70%</li> <li>- Metals- 85-90%</li> <li>- Pathogens- 90%</li> </ul>
	Infiltration Trenches	<ul style="list-style-type: none"> <li>- Shallow trenches filled with stone</li> <li>- Designed to capture sheet flow or pipe inflow</li> </ul>	<ul style="list-style-type: none"> <li>- TSS- 80% with one or more pretreatment BMPs</li> <li>- Total Nitrogen- 40-70%</li> <li>- Total Phosphorus 40-70%</li> <li>- Metals- 85-90%</li> <li>- Pathogens- up to 90%</li> </ul>

	Leaching Catch Basins	<ul style="list-style-type: none"> <li>- Concrete barrel that allows runoff to leach into the ground</li> <li>- Two configurations: standalone barrel/riser and barrel/riser combined with deep sump catch basins that provide pretreatment</li> </ul>	<ul style="list-style-type: none"> <li>- TSS- 80% if combined with deep sump catch basin and if designed to be offline</li> </ul>
	Subsurface Structures	<ul style="list-style-type: none"> <li>- Underground systems that capture runoff and slowly infiltrate into the groundwater</li> </ul>	<ul style="list-style-type: none"> <li>- TSS- 80%</li> </ul>
Other BMPs	Dry Detention Basin	<ul style="list-style-type: none"> <li>- Impounded/excavated basin for short term detention of runoff</li> </ul>	<ul style="list-style-type: none"> <li>- Total Nitrogen- 10-50%</li> <li>- Total Phosphorus- 10-30%</li> <li>- Metals- 30-50%</li> <li>- Pathogens- &lt;10%</li> </ul>
	Green Roofs	<ul style="list-style-type: none"> <li>- Permanent rooftop planting system</li> </ul>	<ul style="list-style-type: none"> <li>- Total Phosphorus-increases amount</li> </ul>
	Porous Pavement	<ul style="list-style-type: none"> <li>- Pavement with a higher percentage of air voids</li> </ul>	<ul style="list-style-type: none"> <li>- TSS- 80%</li> </ul>
	Rain Barrels and Cisterns	<ul style="list-style-type: none"> <li>- Rooftop runoff collectors</li> <li>- Reused water for landscaping and other non-potable uses</li> </ul>	<ul style="list-style-type: none"> <li>- Offers no removal benefit, rooftop runoff presumed to be clean</li> </ul>

(Mass Department of Environmental Protection, 2019)

**Appendix B: Gantt Chart**

	A Term		B Term		C Term			D Term	
	Sept.	Oct.	Nov.	Dec.	Jan.	Feb.	March	April	May
Lit. Review									
Sampling									
Testing									
Analysis									
Design									
Report									
PPP*									

\* PPP= Project Presentation Preparation



## Appendix C: Sampling Procedure

### Preparation for testing

#### Materials

- Sampling bottles- cleaned
  - One 1L bottle
  - Two 250mL bottle
    - One sanitized for bacteria testing
- Cooler with ice
- Disposable gloves
- Thermometer
- Labels- written out beforehand
- Notebook
- Sharpie or pen
- YSI Model 85 probe

#### Before sampling

- Clean sampling bottles if used
  - Rinse out bottles three times with DI water
- Communicate goals of trip
- Equipment at full battery
- Label bottles with code to speed up process

#### In field

- Use the YSI Model 85 probe to determine water temperature, Dissolved Oxygen concentration, and specific conductance of the sampling site
  - Note weather conditions too- helps to take pictures of areas sourced
- Record amount of rain in gauge

#### Procedure for sampling

##### Standing Bodies of Water Sampling

1. Put on clean gloves- new gloves for each location
2. Use the YSI Model 85 probe to test for water temperature, DO and specific conductance
  - a. Note the units and the results
3. Uncap a 1L container, be careful not to touch the rim of the bottle, rinse it out three times with water that you are sampling
  - a. Collect and sample from different locations to not disturb sediment on the bottom
4. Collect the water - fill container as much as possible- do not touch inside of bottle or cap (do not place in pocket or on the ground)
5. Cap the bottle and note time sample was taken- write down time, date, label ID, and location of the collected sample

6. Place in cooler
7. Repeat steps 3 to 6 in the same location for two 250mL bottles

Used [Worcester airport](#) and [Stillwater river gauge](#) in sterling MA to determine info about rain event

Sample ID	Date	Time	Weather	Location	Temp	Notes

Label code:

- Location
- Sample number
- Date of collection
- MQP group name

## Appendix D: Total Phosphorus Procedure

### Total Phosphorus Procedure:

1. Clean glassware (100 mL beakers, 100 mL volumetric flasks, 25 mL volumetric flasks)
  - a. Soak in acid bath overnight, rinse 3 times with tap water, rinse 3 times with DI water
2. Label 100 mL beakers with blank, standards and sample IDs
3. Make Standards
  - a. Take out the labeled bottle of standard from the refrigerator
  - b. Get 100 mL volumetric flasks
  - c. Label flasks for standards
  - d. Pipette standard amounts according to the sheet
  - e. Fill flasks with DI water from e-pure tap, then use a spray bottle to fill the flask to the line
  - f. Add parafilm to the flasks
  - g. Invert flasks 5 times each
4. Pour blank, standards, samples into 25 mL volumetric flasks
  - a. Rinse the flasks before filling: add a little, swirl, dump out (do this twice)
  - b. Use disposable, plastic pipette if over line
  - c. Pour into corresponding beaker, rinse flask with spray bottle twice
5. Digest samples (about 1 mL of standards and samples will be left in the beakers)
  - a. Add 5 mL of nitric acid and 1 mL of sulfuric acid to each beaker
  - b. Heat on hot plate until ~1 mL left or it starts fuming
  - c. Add drops of H<sub>2</sub>O<sub>2</sub> if there are too many organics in the sample (cloudy and colored)
6. Turn on spectrophotometer
7. Make sure the spectrophotometer is on single wavelength and the wavelength is set to 400 nm (change wavelength by pressing manual program)
8. Filter samples
  - a. Use #4 filter paper, Whatman
  - b. Funnels
9. Get 3 Solutions
  - a. Phenolphthalein: 1000 mL, white/clear bottle, clear solution
  - b. Molybdovanadate: 1000 mL, white/clear bottle, yellow solution
  - c. NaOH: 6.25 N, white bottle, clear solution
10. Get supplies for each solution
  - a. 2 disposable droppers, 100 mL beaker
  - b. 1 mL pipette and tip (1-5 mL, large tips in drawer)
11. Get DI water (in squirt bottle), paper towels, gloves, “my” cell from water lab, large waste beaker
12. Transfer blank solution from beaker into cell; rinse with DI water to get all of the sample
13. Add 1 drop of Phenolphthalein

14. Add NaOH with dropper until sample turns pink
15. Add E-pure water to the line on the cell with squirt bottle
16. Add/pipette 1 mL of Molybdovanadate
17. Set spectrophotometer timer to 3 minutes
18. Place the cell in the spectrophotometer (kimwipe first) with the white line mark facing outwards when the timer reaches 0
19. Press Zero
20. Rinse cell into large waste beaker
21. Repeat steps 12-20 for the rest of the samples and standards, except press read for step 19
22. Dispose the waste into hazardous waste bottle for total phosphorus

#### **Appendix E: ICS Anions Procedure**

ICS Anions test - sample preparation:

1. Filter samples through 0.45  $\mu\text{m}$  syringe filter (sample should be at least 10 mL), store sample in refrigerator until analysis

2. On the test day,
  - a. Get vials, caps, marker, tool (black cylinder), plastic tray
  - b. Label vials
  - c. Use tray when filling (fill to the top of the tray, doesn't need to be exact, roughly 8 mL)
  - d. Use tool to put on caps ("hole" end first and the other end further down)
  - e. Carousel release/align, then set up the autosampler in this order:
    - i. 2 blanks
    - ii. Standards = 100, 200, 400, 800, 1200, 3000 ppb
    - iii. Samples
    - iv. 3 blanks (2 blanks and one for auto shutdown)

**Appendix F: ICPMS Metal Test Procedure:**

ICPMS metal test - sample preparation:

1. Label the 15 mL test tubes
2. Filter samples through 0.45  $\mu\text{m}$  syringe filter into 15 mL test tubes to reach the 10 mL line
3. Add 100  $\mu\text{L}$  of concentrated nitric acid ( $\text{HNO}_3$ ) to each test tube
4. Mix well
5. Store samples in refrigerator until analysis

## **Appendix G: Ammonia (NH<sub>3</sub>) procedure**

Ammonia (NH<sub>3</sub>) procedure:

1. Filter samples
  - a. Centrifuge tube
  - b. Syringes and 0.45 µm syringe filters
2. Turn on spectrophotometer (don't need to wait hours before using)
3. Make sure the spectrophotometer is set to single wavelength and the wavelength is set to 425 nm
4. Make standards
  - a. Get Nitrogen-Ammonium standard solution 100 mg/L as NH<sub>3</sub>-N from chem. Refrigerator
  - b. Get 100 mL volumetric flasks
  - c. Label flasks for standards
  - d. Pipette standard amounts according to sheet
  - e. Fill flasks with DI water from e-pure tap, then use a spray bottle to fill the flask to the line
  - f. Add parafilm to the flasks
  - g. Invert flasks 5 times each
5. Get 3 solutions from the sprinkler room
  - a. Mineral stabilizer: clear solution; small dropper bottle
  - b. Polyvinyl Alcohol Dispersing Agent (PADA): purple solution; small, dropper bottle
  - c. Nessler Reagent: yellow solution; larger bottle
6. Get supplies for each solution
  - a. 1 mL - pipette and tip (1-5 mL, large tips in drawer)
  - b. 25 mL UV-vis cell
  - c. Rubber stopper
7. Add E-pure water to 25 mL line of cell; for samples, pour from bottle (shake first), use disposable dropper for each one if filled over the line
8. Add 3 drops of Mineral Stabilizer, cap and invert several times
9. Add 3 drops of PADA, cap and invert several times
10. add/pipette 1 mL of Nessler, cap and invert several times
11. On the spec. Press timer, set to 1 minute
12. Place the cell in the machine, with the white line mark facing outwards
13. Start the timer. When the timer hits zero, press Zero
14. Rinse cell with DI water into waste beaker
15. Repeat steps 7-14 for the rest of the samples and standards, except press Read instead of Zero
16. Dispose of waste into Nessler Reagent hazardous waste bottle

## **Appendix H: Bacteria procedure**

Bacteria procedure:

1. Prepare log phase E. Coli (ATCC11775) for positive control
  - a. Make 2 cultures in laminar flow hood sprayed with 50% alcohol. Flame tubes, tops, caps, and loop in between each use
    - i. Add 50 mL TSB to a labeled flask
    - ii. Autoclave
    - iii. Add one loopful of frozen E. coli stock
    - iv. Incubate at 35 °C at 100 rpm for 16-18 hours
2. Prepare Samples
  - a. Run cap and bottle neck under flame before and after water is transferred, for sterilization purposes
    - i. Remove first sample from refrigerator
    - ii. Invert bottle a few times to mix contents
    - iii. Pour 100 mL of water into dilution bottle
3. Quanti-Tray preparation
  - a. Add one colilert packet to each dilution bottle for total coliforms/E. Coli, and add one enterolert packet to each dilution bottle for enterococci
  - b. After adding colilert/enterolert, re-cap bottle and shake until no particles are left in suspension. Allow bottle to sit for 1-2 minutes for colilert/enterolert to dissolve
  - c. Slowly invert dilution bottle being careful not to create bubbles, then uncap dilution bottle
  - d. Slowly pour contents into Quanti-Tray being careful not to create bubble or turbulence
  - e. Place Quanti-Trays onto orange Quanti-Tray holder and run through Quanti-Tray sealer machine
  - f. Write the time down on the Quanti-Tray and place in incubator at 36 °C for colilert and 41 °C for enterolert
4. Reading Quanti-Trays
  - a. After 24 hours remove Quanti-Trays from incubator and read under hood
  - b. Count and record the number of yellow large and small wells (total coliform)
  - c. Turn off lights and, using a U.V. light, count and quantify the number of wells that are fluorescent (E. coli and enterococci)
  - d. Use standard tray as a comparison
  - e. Use cross reference sheet to quantify bacteria content



## Appendix I: TSS Procedure

### TSS Procedure:

1. Set up filtration apparatus, insert a filter, and apply vacuum
2. Wet the filter with a small volume of deionized water to seat it
3. Shake the sample vigorously and then measure out the predetermined sample volume using a graduated cylinder. Record the volume filtered in liters on the bench sheet
4. Rinse the graduated cylinder and filter with three 20 mL volumes of DI water, allowing complete drainage between washings
5. Continue suction for three minutes after filtration is complete
6. Carefully transfer the filter to an aluminum weighing dish, and place filter on a cookie sheet or similar device
7. Place filters on sheet into an oven set to  $104 \pm 1$  °C and dry for a minimum of one hour
8. Remove filters from oven and transfer them to a desiccator to cool in room temperature
9. Weigh one sample filter to the nearest 0.1 mg. On the bench sheet record the sample ID and the mass (Mass 1) in the “Weight check” section.
10. Repeat steps 7 - 9 for all samples
11. Repeat steps 7 - 10 and record the mass as “Mass 2” in the “Weight Check” section of the bench sheet. If the mass of the filter increases less than 0.5 mg or the change in the mass of the solids is less than 4% of the previously measured mass, then continue with TSS calculations
  - a. If the mass of the filter increases by more than 0.5 mg or the change in the mass of the solids is less than 4% of the previously measured mass. Record each additional mass on the bench sheet as “Mass 3”, “Mass 4”, etc. Use the back of the bench sheet if necessary
12. Record the Oven Dry Mass (in mg) on the bench sheet
13. Calculate TSS

Dump remaining sample down the drain, remove label, and rinse with tap water to remove any solids from the bottle. Wash bottles according to the bottle prep non-metals SOP 0150R01

**Appendix J: Design Matrix for BMP Selection**

Criteria	Weighting	OPTIONS					
		OPTION 1		OPTION 2		OPTION 3	
		Score	Total	Score	Total	Score	Total
TSS Removal	8		0		0		0
Total Nitrogen	7		0		0		0
TP Removal	10		0		0		0
Metals	9		0		0		0
Pathogens	11		0		0		0
Peak Flow	1		0		0		0
Recharge	3		0		0		0
Cost	6		0		0		0
Maintenance	5		0		0		0
Construction Time	2		0		0		0
Area Required	4		0		0		0
<b>TOTAL</b>			0		0		0

(“Decision Matrix Analysis”, 2009-2018)

<https://docs.google.com/spreadsheets/d/1xlqKizVEVQzhFsz0JEgJK1RR0gQj6smEvZQaUkg6mo8/edit?usp=sharing>

**Appendix M: ArcMap Contour Map**



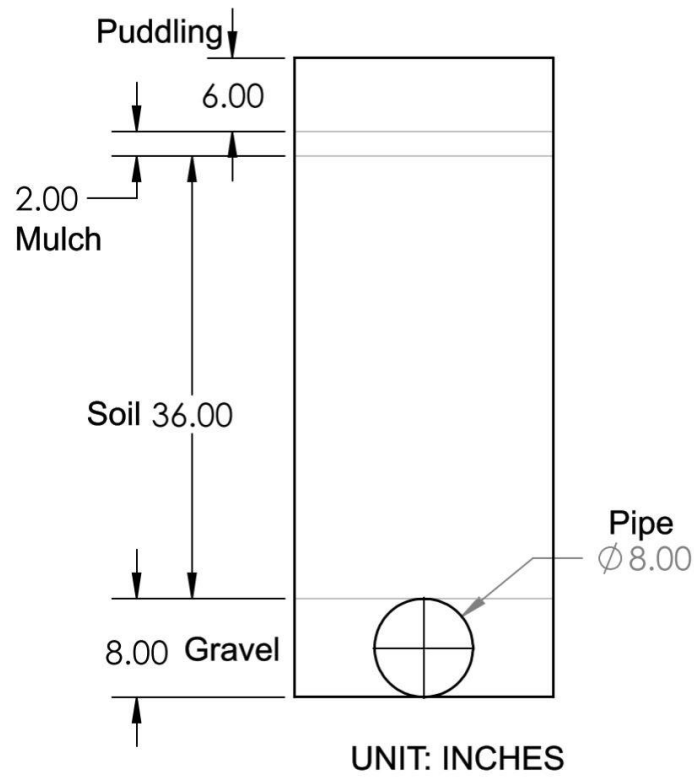
The contour map of the EcoTarium.

## Appendix N: List of Rain Garden Plants

- Perennial Flowers:
  - Butterfly Milkweed (*Asclepias tuberosa*) - orange flowers that attract Monarch Butterflies
  - Bee Balm (*Monarda didyma*) - pink or red flowers attract hummingbirds
  - New England Aster (*Aster novae angliae*) - bright purple flowers in early fall
  - Turtlehead (*Chelone Glabra*) - interesting lavender flower spikes in early fall
  - Black-Eyed Susan (*Rudbeckia hirta*) - golden flowers bloom in summer and fall
  - Coneflower (*Echinacea purpurea*) - striking pink or white flowers attract butterflies
  - Boneset (*Eupatorium perfoliatum*) - sweet smelling white blooms attract butterflies
  - Blue Wild Indigo (*Baptisia australis*) - blue flowers and interesting seed pods
- Grasses:
  - Switch Grass (*Panicum virgatum*) - quick growing, spring wild life cover
  - Little Bluestem (*Schizachyrium scoparium*) - turns reddish orange in fall
- Shrubs:
  - Sweet Pepperbrush (*Clethra alnifolia*) - fragrant flowers attract butterflies
  - Red Twig Dogwood (*Cornus sericea*) - red stems make a winter highlight
  - Bridalwreath Spirea (*Spirea latifolia*) - cluster of small white flowers

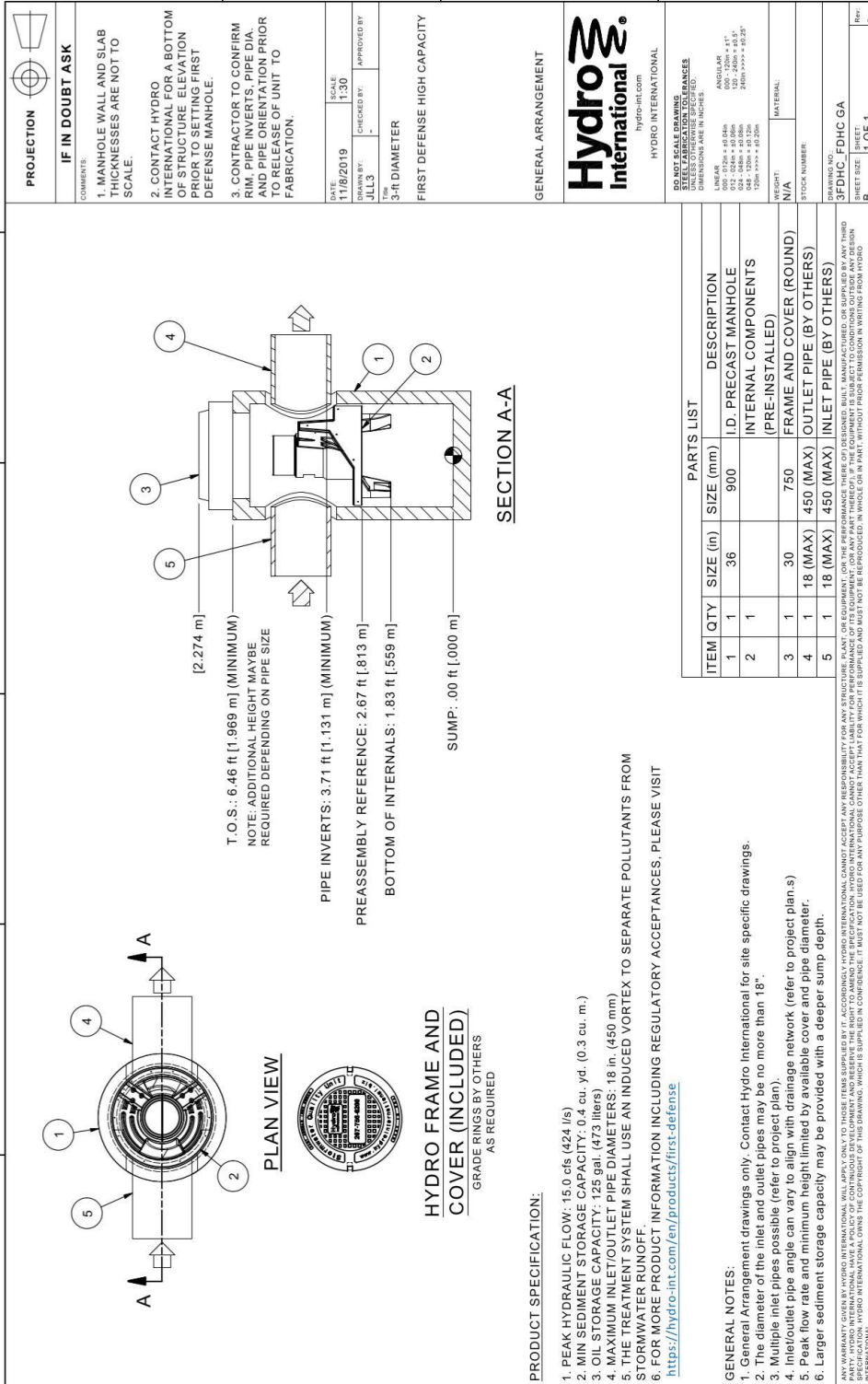
Source: [http://commonwaters.org/images/stories/pdfs/raingardn\\_gde.pdf](http://commonwaters.org/images/stories/pdfs/raingardn_gde.pdf)

# Appendix O: Rain Garden Drawing



## **Appendix P: Oil/Grit Separator Drawing**





**PROJECTION**

**IF IN DOUBT ASK**

COMMENTS:  
 1. MANHOLE WALL AND SLAB THICKNESSES ARE NOT TO SCALE.  
 2. CONTACT HYDRO INTERNATIONAL FOR A BOTTOM OF STRUCTURE ELEVATION PRIOR TO SETTING FIRST DEFENSE MANHOLE.  
 3. CONTRACTOR TO CONFIRM ALL DIMENSIONS, MATERIALS AND PIPE ORIENTATION PRIOR TO RELEASE OF UNIT TO FABRICATION.

DATE: 11/8/2019 SCALE: 1:30  
 DRAWN BY: JLL3 CHECKED BY: APPROVED BY:  
 3/4" DIAMETER  
 FIRST DEFENSE HIGH CAPACITY

GENERAL ARRANGEMENT



HYDRO INTERNATIONAL  
 hydro-int.com

DO NOT SCALE DRAWINGS  
 STEEL FABRICATION DIMENSIONS  
 DIMENSIONS ARE IN INCHES.  
 LINEAR: 000 - 25200 = 10:254  
 000 - 25200 = 1:125  
 000 - 25200 = 1:125  
 000 - 25200 = 1:125  
 1200 - 33000 = 10:254  
 WEIGHT: MATERIAL:  
 STOCK NUMBER:  
 DRAWING NO.:  
 3FDHC - FDHC GA  
 SHEET SIZE: 1 OF 1

**SECTION A-A**

**PARTS LIST**

ITEM	QTY	SIZE (in)	SIZE (mm)	DESCRIPTION
1	1	36	900	I.D. PRECAST MANHOLE
2	1			INTERNAL COMPONENTS (PRE-INSTALLED)
3	1	30	750	FRAME AND COVER (ROUND)
4	1	18 (MAX)	450 (MAX)	OUTLET PIPE (BY OTHERS)
5	1	18 (MAX)	450 (MAX)	INLET PIPE (BY OTHERS)

**PRODUCT SPECIFICATION:**

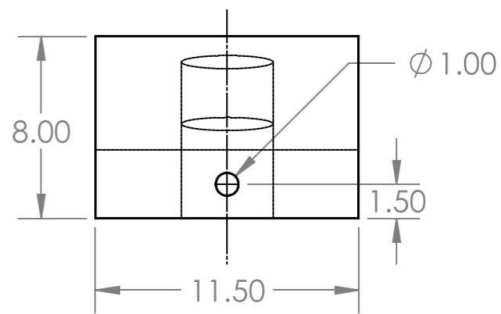
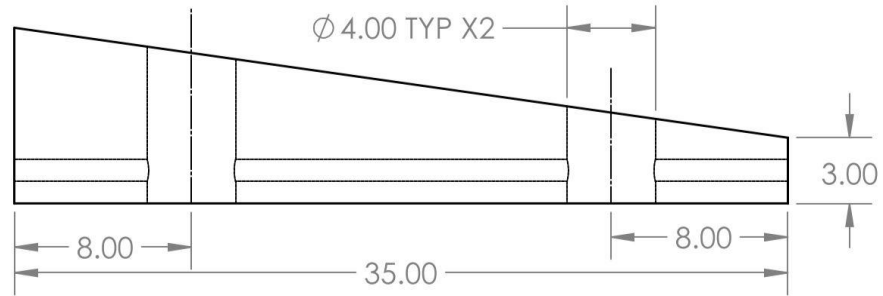
1. PEAK HYDRAULIC FLOW: 15.0 G/s (424 l/s)
2. MIN SEDIMENT STORAGE CAPACITY: 0.4 cu. yd. (0.3 cu. m.)
3. OIL STORAGE CAPACITY: 125 gal. (473 liters)
4. MAXIMUM INLET/OUTLET PIPE DIAMETERS: 18 in. (450 mm)
5. THE TREATMENT SYSTEM SHALL USE AN INDUCED VORTEX TO SEPARATE POLLUTANTS FROM STORMWATER RUNOFF.
6. FOR MORE PRODUCT INFORMATION INCLUDING REGULATORY ACCEPTANCES, PLEASE VISIT <https://hydro-int.com/en/products/first-defense>

**GENERAL NOTES:**

1. General Arrangement drawings only. Contact Hydro International for site specific drawings.
2. The diameter of the inlet and outlet pipes may be no more than 18".
3. Multiple inlet pipes possible (refer to project plan).
4. Inlet/outlet pipe angle can vary to align with drainage network (refer to project plan.s)
5. Peak flow rate and minimum height limited by available cover and pipe diameter.
6. Larger sediment storage capacity may be provided with a deeper sump depth.

ANY WARRANTY COVERED BY HYDRO INTERNATIONAL WILL APPLY ONLY TO THOSE TERMS SUPPLIED BY IT. ACCORDINGLY HYDRO INTERNATIONAL CANNOT ACCEPT ANY RESPONSIBILITY FOR ANY STRUCTURE, PLANT, OR EQUIPMENT, OR THE PERFORMANCE THEREOF OF DESIGNER, BUILT, MANUFACTURED, OR SUPPLIED BY ANY THIRD PARTY. HYDRO INTERNATIONAL OWNS THE COPYRIGHT OF THIS DRAWING, WHICH IS SUPPLIED IN CONFIDENCE. IT MUST NOT BE REPRODUCED FOR ANY PURPOSE OTHER THAN THAT FOR WHICH IT IS SUPPLIED AND MUST NOT BE REPRODUCED IN WHOLE OR IN PART, WITHOUT PRIOR PERMISSION IN WRITING FROM HYDRO INTERNATIONAL.

**Appendix Q: Infiltration Trench Drawing**



UNITS: FEET