

Designing a Rafting Mooring Buoy for the Puerto Rican Cays

An Interactive Qualifying Project proposal submitted to the Faculty of
Worcester Polytechnic Institute in partial fulfillment of the
requirements for the Degree of Bachelor of Science.



18 December 2014

Submitted by:

Hussain Muhammad Abdullah Bin Riaz Khan
Kelsey Ouellette
Kaitlin Poss
Sarah Sisson

pr14boats@wpi.edu

Submitted to:

Project Advisors:

Professor Lauren Mathews
Professor Tina-Marie Ranalli

Project Liaison:

Aileen Velazco, el Departamento de Recursos Naturales y Ambientales

Acknowledgements

Our team would like to acknowledge and express our sincere gratitude to the following people and institutions for their support and contributions throughout our project:

- The Departamento de Recursos Naturales y Ambientales (DRNA) for sponsoring our project and providing invaluable information and a workspace for our team
- Our project liaison, Aileen Velazco, for her insight and for providing us valuable information and feedback
- Our advisors, Professor Lauren Mathews and Professor Tina-Marie Ranalli, for their support and constant guidance to ensure the success of our project
- Our instructor for preparatory class, Professor Stephen McCauley, for teaching and preparing us for this project
- DRNA staff members Carlos Matos, Edwin Rodríguez, Carlos Cao and Marjorie Rey for providing us valuable information and support to ensure the success of our project
- Editor and director of the La Regata newspaper, Benito Rodríguez, for helping us gain information through the newspaper's subscribers
- DRNA rangers, Edwin Romero and Elia Lopez, for aiding with the survey distribution process

Thank you all. We are truly grateful for all of your time and guidance.

Authorship

We, as a group, have researched and completed this project together. All sections of this report were written and edited through our combined efforts.

Contents

Acknowledgements	2
Authorship	3
Executive Summary.....	11
1.0 Introduction	17
2.0 Background.....	19
2.1.1 Coral reefs.....	19
2.1.2 Mangroves and seagrass	21
2.1.3 Status of marine ecosystems in Puerto Rico.....	22
2.1.4 Damage caused by anchors.....	24
2.2 Boat-securing devices.....	26
2.2.1 Boat anchors	26
2.2.2 Moorings.....	26
2.2.3 Rafting mooring buoy.....	31
2.3 The F-27 Project	32
2.4 Current mooring buoy systems around the world.....	33
2.4.1 United States Virgin Islands	34
2.4.2 British Virgin Islands.....	40
2.4.3 Other mooring buoy designs.....	41
2.5 Political and social aspects of boat anchors and mooring buoys.....	44
2.5.1 Current anchoring policies and their enforcement.....	44
2.5.2 Attempts to educate boaters.....	45
2.5.3 Social aspects of the mooring buoy system	46
2.5.4 Social aspects of coral reef protection	46
2.5.5 Social aspects relating to compliance	50
2.6 Social marketing campaigns	52
2.6.1 Community-based social marketing campaign.....	52
2.6.2 De-marketing social campaign	53
2.7 Past projects.....	54
2.7.1 Results of the most recent project.....	55
2.7.2 Recommendations	56
2.8 Summary.....	57
3.0 Methodology.....	58

3.1 Gathering stakeholder knowledge	58
3.2 Creating a design of the rafting mooring	61
3.3 Gathering feedback from boaters	62
3.4 Comparison of designs	64
3.4.1 Cost.....	66
3.4.2 Strength.....	67
3.4.3 Ease-of-use	70
3.4.4 Maintenance.....	71
3.4.5 Installation	72
3.5 Making a strategic plan.....	73
3.5.1 Implementation and maintenance plan	73
3.5.2. Promotion plan	75
4.0 Results and recommendations	79
4.1 Gathering stakeholder knowledge	79
4.2 Rafting mooring design	92
4.2.1 Preliminary drawings.....	92
4.2.2 SolidWorks parts	97
4.3 Feedback from stakeholders	103
4.4 Comparison of designs	107
4.4.1 Final SolidWorks design	111
4.5 Strategic plan.....	113
5.0 Conclusion	114
6.0 Bibliography	115
7.0 Appendices	122
Appendix A: Mooring buoy system and ecology survey in English	122
Appendix B: Estudio de boyas de amarres y sistemas marinos.....	127
Appendix C: Email to the <i>La Regata</i> newspaper subscribers.....	132
Appendix D: Raw data for Survey #1.....	134
Appendix E: Rafting mooring survey in English	160
Appendix F: Rafting mooring survey in Spanish	162
Appendix G: Second email to the <i>La Regata</i> newspaper subscribers regarding the second surveys	164
Appendix H: Original email sent to Edwin Rodriguez (Spanish)	165
Appendix I: Email sent to Edwin Rodriguez translated to English	166

Appendix J: Original response email from Edwin - Spanish	167
Appendix K: Response email from Edwin - translated to English	168
Appendix L: List of costs for one mooring buoy	169
Appendix M: Components and prices of a mooring buoy.....	170
Appendix N: Mooring buoy inspection techniques	171
Appendix O: Informal Interview with Carlos Matos.....	172
Appendix P: Raw data for survey #2.....	175
Appendix Q: Strategic plan	178
Appendix R: Calculations for rafting mooring designs.....	189

List of Figures

Figure 1: The final 3D SolidWorks model of the rope design.....	14
Figure 2: A healthy coral reef vs. an unhealthy coral reef (Coral Reef Care, 2011).	20
Figure 3: A photograph of common Mangroves (Mangroves, 2013).....	21
Figure 4: A healthy seagrass bed in Puerto Rico (Batista, 2014).	22
Figure 5: A map of Puerto Rico and the surrounding islands (Max Energy Limited, 2009).....	23
Figure 6: Broken corals caused by physical damage (National Oceanic and Atmospheric Administration, 2010).....	25
Figure 7: Fluke Anchor (USPS, 2011).	26
Figure 8: Mooring Buoy (National Oceanic and Atmospheric Administration, 2005)	28
Figure 9: Different lines required for a mooring buoy (National Oceanic and Atmospheric Administration, 2005).....	29
Figure 10: Types of mooring embedment anchors (National Oceanic and Atmospheric Administration, 2005).....	30
Figure 11: The correct way a boat latches onto a simple-structured mooring buoy (National Park Service, 2014).....	31
Figure 12: Rafting behavior seen in Culebra (DRNA, 2013).	32
Figure 13: Scarring of seagrass in Matias Cay in Salinas (DRNA, 2006).....	33
Figure 14: The instructions given in the guide on how to correctly moor a boat (National Park Service, 2014).....	35
Figure 15: The international symbol that means “boats are not permitted here” (Skipper Online Services, 2014).....	37
Figure 16: The instructions given in the guide on how to properly use anchors (National Park Service, 2014).....	38
Figure 17: A map of the USVI with locations of mooring buoys and coral reef hot spots (National Park Service, 2014).....	39
Figure 18: The WaterLily rafting mooring (ACRI-In, 2014).	41
Figure 19: A computer-aided design of the WaterLily rafting mooring with labels of each part (ACRI-In, 2014). See Table 3 for English translations.	42
Figure 20: An aerial Photograph of Caracoles Cay in La Parguera Natural Reserve shows the rafting behavior during a weekend of the main boating season (DRNA, 2011)	46
Figure 21: A scatter plot of the socio-economic development index versus the reef fish biomass (Cinner et al, 2009).....	47
Figure 22: A map of areas in Puerto Rico that were analyzed by Bouchard et al 2013	55
Figure 23: An alternative mooring design (Bouchard et al, 2013)	56
Figure 24: Example of a 2D design in SolidWorks (SolidWorks, 2014).	62
Figure 25: A map of Puerto Rico with existing mooring buoys (in pink); not all buoys can be seen individually because the points overlap in high-density regions.....	74
Figure 26: A map of Culebrita with existing moorings shown in pink	74
Figure 27: A boat attached to a mooring buoy and anchored at the same time	76

Figure 28: The front page of an educational brochure distributed among the marinas (C. Matos, Personal Communication, 2014)	77
Figure 29: An educational pamphlet that was distributed at various marinas by the DRNA (C. Matos, Personal Communication, 2014)	78
Figure 30: A graph showing responses to “List marinas and cays where you most often boat” from each of the survey groups in survey 1; n=21 for in-person surveys and n=54 Respondents had the options to give multiple answers.	81
Figure 31: A map showing the most visited places on the (a) east and (b) south coast of Puerto Rico	82
Figure 32: Percentages of people with different boat sizes that replied “yes” to “When boating, do you ever raft onto other boats?”, n=65	83
Figure 33: The column bar graph that shows the results of “I use mooring buoys and tie together (raft) with other boats” compared with age group, n = 89	84
Figure 34: Results of the age groups of people with the answers they gave on “When I use the mooring buoys I also drop anchors”, n = 90	85
Figure 35: Results to question 17 from respondents who said “Agree or “Strongly Agree” to the statement “I am comfort with latching my boat onto the mooring buoy.” N=16 for the in-person surveys with a standard error of 1.10 and for the La Regata subscribers, n=52	88
Figure 36: From among the boaters who reported that they engage in rafting, percentage of respondents that selected ‘Socializing’ as one of the reasons they boat, n=93	90
Figure 37: The average online survey responses to Question 17 statements in comparison to responses to “When boating, do you ever raft (tie two or more boats together) onto other boats?”, n=68	91
Figure 38: The average in-person survey responses to Question 17 statements in comparison to responses to “When boating, do you ever raft (tie two or more boats together) onto other boats?”, n=22	92
Figure 39: Original cable design created by Bouchard et al 2013. Components in this image are not drawn to scale.	93
Figure 40: Ring link design; components in this image are not drawn to scale.	94
Figure 41: Helix anchor design; components in this image are not drawn to scale.....	94
Figure 42: Rope design; components in this image are not drawn to scale.....	95
Figure 43: A modified design with double-eye swivel ring; components in this image are not drawn to scale	96
Figure 44: A double-eyed swivel ring	97
Figure 45: Opaque mooring buoy	99
Figure 46: Transparent mooring buoy with the hidden lines visible	100
Figure 47: A standard boat (Vlad, 2014)	101
Figure 48: A cleat for the boat.....	102
Figure 49: The MR-SR3 Manta Ray anchor.....	102
Figure 50: Average mean scores for the chart with questions relating to ease-of-use and level of comfort of the designs presented; for the first three statements, n=45 and for the last statement n=44 (note that a mean score of 1 coincided with “very difficult” for the first two statements and “very uncomfortable” for the last two statements; 5 coincided with “very easy” for the first two statements and “very comfortable” for the last two statement	103
Figure 51: The mean scores for question 5, 1 is associated with “strongly disagree” and 5 is associated with “strongly agree”; for the first statement, n=43 and for the second and third statements, n=44; these mean scores have a standard error of 1.16.....	106

Figure 52: The final 3D SolidWorks model of the rope design.....	112
Figure 53: The results to “What do you do when you’re boating?”; n=93; respondents had the option to give multiple answers.	140
Figure 54: A graph showing the results to “How long have you been boating?”; n= 89	141
Figure 55: A histogram of the results for “How many days a week do you use your boat?”; n=88	141
Figure 56: A pie chart of the results for “How many days a week do you use your boat?”; n=88	142
Figure 57: The results “On a typical day, how long are you out on your boat?”; n=89	143
Figure 58: The figure that shows the results of “What is the length of your boat?”; n = 93	144
Figure 59: The responses to the question “When boating, do you raft (tie two or more boats together) onto other boats?, n = 93	145
Figure 60: Results in a bar graph for the “If yes; on average, how many boats?” in integers, n = 30	146
Figure 61: Results in a column bar graph for the “If yes; on average, how many boats?” in ranges, n = 30	147
Figure 62: The results that represent the respondents’ ability to recognize coral reefs and seagrass, n = 91	148
Figure 63: The results of the question that asks about the commonality of marine ecosystems, n=93	149
Figure 64: The results for the question that pertains to the importance of coral reefs in the marine ecosystem, n=93	150
Figure 65: The results for the survey question pertaining to coral reef function, n is approximately 93 ...	151
Figure 66: The results of the survey question pertaining to the coral reefs' risk of local extinction in Puerto Rico, n=89	152
Figure 67: The results of the survey question that asked “Does boat anchoring put marine life in danger?”; n=92.....	153
Figure 68: The results of the survey question that asked “Do you know what mooring buoys are and why they are used?”; for the subscribers, n=71 and for the in-person surveys; n=22.....	153
Figure 69: The results of the survey question that asked “How many mooring buoys are there around the cays?”; for the La Regata subscribers, n=67 and for the in-person surveys; n=14.....	154
Figure 70: Possible locations for rafting moorings at Las Pelás	179
Figure 71: Possible locations for rafting moorings at Dakiti.....	180
Figure 72: Possible locations for rafting moorings at Playa Tortuga	180
Figure 73: Possible locations for rafting moorings at Palomino	180
Figure 74: Knot linkage of a standard DRNA mooring buoy.....	182
Figure 75: Boaters engaging in rafting while dropping anchor and using mooring buoys.....	184
Figure 76: shows the layout of our Facebook page.	186
Figure 77: Information showing statistical tools that Facebook offers for page owners.....	187
Figure 78: A free-body diagram of underwater forces acting upon the ring link design.....	190
Figure 79: Free-body diagram of forces acting upon the helix design underwater	191
Figure 80: A free-body diagram of the underwater forces acting upon the rope design	192
Figure 81: A free-body diagram of underwater forces acting upon the swivel design.....	194

List of Tables

Table 1: The parts of the mooring buoy	27
Table 2: Size limits for mooring buoys around the USVI (National Park Service, 2014)	36
Table 3: A French to English translation of the specific parts of the WaterLily (ACRI-IN, personal communication, 2014)	43
Table 4: Some examples of factors that are not specified in anchoring policies	45
Table 5: A list of statistical traits from the scatter plot above (Cinner et al, 2009)	48
Table 6: The results for advisories involving crabs (Burger, 2004)	50
Table 7: The results for advisories involving fish (Burger, 2004)	51
Table 8: The scoring sheet for value analysis; all of the ranks for the categories and factors are explained in the text	65
Table 9: Blank design value analysis	66
Table 10: How anchoring violations could be punished by the DRNA	87
Table 11: Technical specifications of Taylor Made mooring buoy (Taylor Made Sur-Moor T3C Mooring Buoys, 2008)	98
Table 12: Design value analysis of the rope link design	108
Table 13: Design value analysis of the helix design	109
Table 14: Design value analysis of the rope design	110
Table 15: Design value analysis of the swivel design	111
Table 16: The results to question 17	155
Table 17: Different components of mooring buoys and machinery with prices (NOAA, 2005)	170
Table 18: A table showing different inspection techniques US Navy uses for mooring buoys (US Navy NAVFAC MO-124, 1987)	171
Table 19: Lists of buoy pairs, distances, water depths and rope needed to complete that design	181
Table 20: Dimensions of specific boat brands	189

Executive Summary

The Departamento de Recursos Naturales y Ambientales (DRNA) of Puerto Rico has been striving to alleviate damage of sensitive marine ecosystems, such as coral reefs and seagrass, caused by boat anchors. In 1990, the DRNA began a project to install mooring buoys around Puerto Rico in areas with high boat traffic and a large concentration of coral reefs or seagrass. There are currently over 320 DRNA mooring buoys around Puerto Rico for public use. Mooring buoys are used as alternative boat-securing devices in place of anchors. However, Bouchard et al (2013) documented that these mooring buoys were being misused. Boaters are using mooring buoys, but they tie to other boats while using them. This behavior is prevalent in Puerto Rico and is known as rafting. These boats are also dropping their anchors while attached to moorings, putting excessive stress on mooring buoys and defeating their purpose. The goal of our project was to design a rafting mooring buoy system so that boaters would be able to raft while using mooring buoys without damaging marine ecosystems. We achieved this goal by addressing a series of objectives. First, we gathered information about the knowledge of boaters and DRNA staff using a survey and conducting informal interviews. We then created sketches of rafting moorings, and surveyed boaters again to ask their opinions and concerns with the designs. Results of the second survey were used in a value analysis to determine the best design for implementation in Puerto Rico. We concluded our project by creating a strategic plan for the DRNA, outlining the installation and promotion of our design.

Methodology

We first determined what boaters already knew about benthic communities and mooring buoys. To do this, we created a survey with questions about mooring buoys, anchors, marine ecosystems, and how all three relate among each other. This survey was distributed online via Facebook and the list of subscribers of *La Regata*, a local nautical newspaper. We also handed out surveys in-person to boaters in San Juan and Culebra Island. We created survey questions to assess what boaters already knew about marine ecosystems and their attitudes towards current mooring buoys.

Using results from the first survey as guidelines, we created four different designs of a rafting mooring buoy. Due to lack of permits, no new permanent anchors could be installed, so we had to assume that any rafting moorings installed in the future would have to be constructed using the existing moorings. Knowing this constraint, we created designs so that the new system could

be constructed with moorings already in place. When drafting the rafting mooring design, we considered our background research and our knowledge of engineering feasibility, as well as boaters' knowledge, opinions, and concerns about existing mooring buoys. We first created two dimensional (2D) sketches of the designs.

We then showed surface components of the 2D designs to boaters by distributing a second survey to the *La Regata* newspaper subscribers and emails obtained from the first survey, asking boaters to give feedback on our designs. Results from this survey aided in the selection of our final design recommendations. We conducted a value analysis to select the most suitable design for the needs of the DRNA and boaters. In this analysis, each design was ranked on five different categories that included: estimated cost, ease-of-use, ease of installation, maintenance, and strength. When our final design was selected, we created the individual parts of the rafting mooring buoy in SolidWorks 2014. In SolidWorks, we assembled a three dimensional (3D) model of the final 2D rafting mooring buoy design using these individual parts.

We used results from both surveys to create a strategic plan for the DRNA to implement and promote usage of the rafting moorings. Informal interviews with the DRNA staff gave us insight on estimated costs and available materials, so we knew what designs would be most appropriate considering the resources available to the DRNA. These interviews also gave us an idea on maintenance and installation for a regular mooring buoy. We also calculated the overall strength of each design using basic engineering fundamentals of static systems, and we were able to determine ease-of-use through results from our second survey. Using results from both surveys and a DRNA database pinpointing the locations of existing mooring buoys, we formulated suggestions for the DRNA. These suggestions included specific locations to install the new rafting mooring buoys, and what boater concerns to address before installation begins. We then created a promotion plan that suggested what information regarding the rafting mooring should be promoted, along with recommended methods of disseminating information the DRNA can use to reach the maximum number of boaters.

Results

We received a total of 97 responses to our initial survey. We received 74 survey responses from the subscribers of the *La Regata* newspaper, 22 responses from in-person surveys, and one response from the social media website, Facebook. From these results, we concluded that most

boaters do feel that they know about the importance of the marine ecosystems such as coral reefs and seagrass. However, data from this survey also showed that boaters continue to drop anchor even when using the mooring buoys. Through the survey and informal interviews with the boaters, we learned that they do not trust the DRNA mooring buoys. Boaters drop their anchors because they want the extra security; they fear the mooring could fail or they do not want the wind to move their boats. This suggests that boaters need to know more information about how much weight the mooring buoys can sustain. Another conclusion we made from our first survey is that boaters do not know about all of the mooring buoys located throughout Puerto Rico. The survey also showed us that when boats raft together, it usually involves anywhere from two to ten other boats. This makes the total number of boats that are rafting together, on average, range from three to eleven boats. This information was important so we knew how many attachment lines to have when creating the rafting mooring design.

Using our design value analysis, we gave each design a score based on our assessment of its cost, strength, ease of use, maintenance, ease of installation, and visibility. We obtained this information through background research, informal interviews with DRNA staff, and results from the second survey to boaters. The results from this survey containing the 2D designs showed that the boaters have a slight preference for a design that uses a rope (throughline) to join the buoys together. Our alternative design uses a metal rod in place of the rope, and boaters indicated that they believe a metal rod would corrode in the ocean and cause its overall strength to weaken.

Based on this value analysis, we chose the Rope design to be most suitable for the Puerto Rican cays. This design received a score of 22 on our value analysis, which was the highest score out of all of the designs. It received a score of 9 for strength, 3 for installation, 3 for maintenance, 3 for cost, and 4 for ease-of-use.

Having completed the value analysis and settled on a final design, we proceeded to create the different parts of the rafting mooring design in SolidWorks. We then assembled all of the parts together to create a visual of the rafting mooring design to be implemented. The image below shows the final 3D design of the rafting mooring to be implemented, seen in Figure 1.

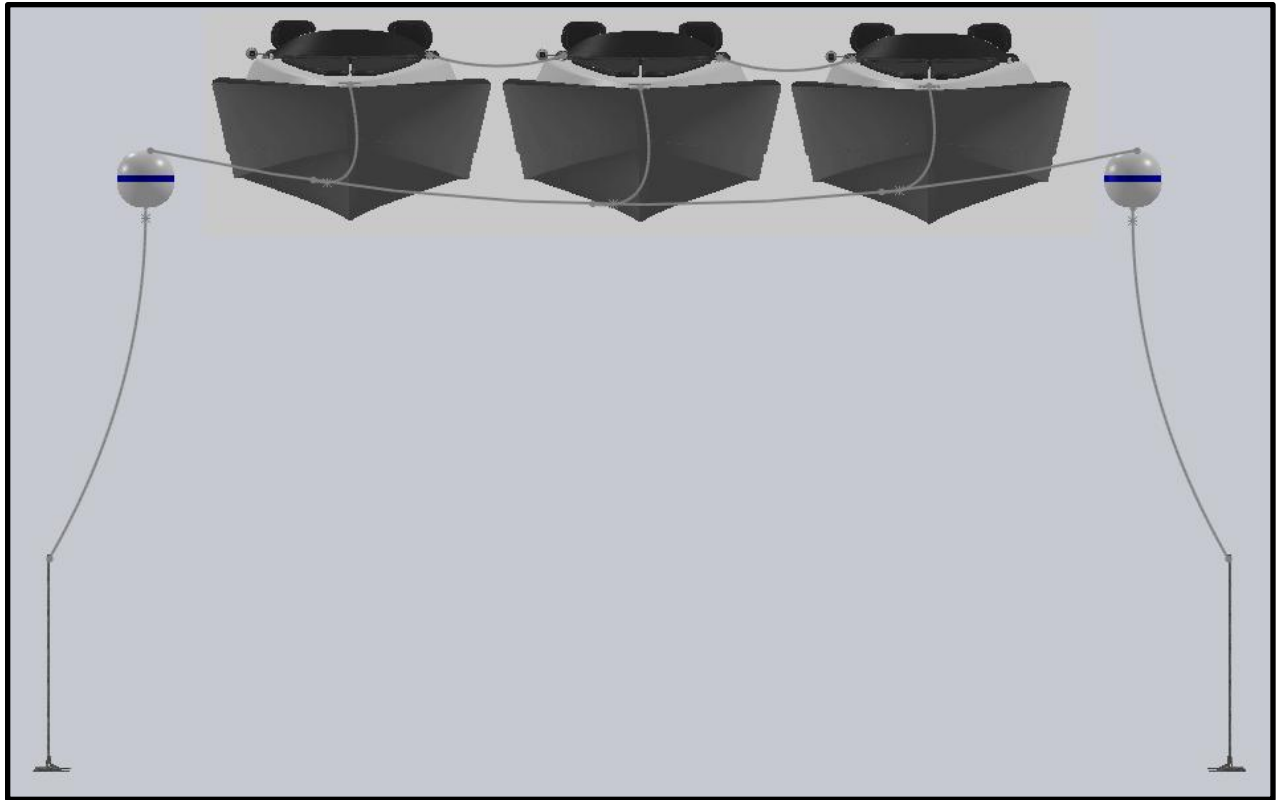

Figure 1: The final 3D SolidWorks model of the rope design

Our strategic plan consisted of two parts. First, we created an installation plan outlining steps the DRNA should take to install our system. This portion of the plan included figures of specific locations, with labeled pairs of mooring buoys that could be constructed into rafting moorings. Feedback from our second survey was also incorporated into the installation plan by including suggestions boaters made about how to make the rafting moorings more visible and user-friendly.

The second part of our strategic plan used results from both surveys and information gathered from informal interviews to develop a promotion plan for the DRNA to use when persuading boaters to accept our rafting moorings. This plan included specific ways for the DRNA to communicate with boaters and included information that would be most effective at encouraging boaters to use our system. For example, our first survey was filled out by 73 boaters through the *La Regata* subscriber list. Although this is a small percentage of their 6,422 subscribers, we learned from the editor of the newspaper that 743 people opened the email containing the survey link. Because the email was seen by a large amount of people, we believe that emailing the *La Regata* subscribers would be a great way to promote our rafting mooring

buoys. Additionally, we received a 95.7% success rate in achieving survey responses when we surveyed boaters in person. Because of this, we suggest that when the rafting mooring buoys are installed, the DRNA rangers could promote the new rafting mooring buoys systems in person, although this may be time consuming.

Recommendations

Although we produced a complete design for a rafting mooring buoy and carried out functional analyses in excel, there are still many steps to take in order to install this system. First, we recommend that the DRNA should obtain more feedback from boaters about the rafting mooring design. Based on informal interviews with numerous boaters, as well as responses to open-ended survey questions, we learned that the boaters trust the mooring buoys located in the United States Virgin Islands more than the mooring buoys in Puerto Rico. Through our background research on current mooring buoys around the world, we learned that residents of the United States Virgin Islands were very involved in the mooring buoy design process. If the DRNA involves the Puerto Rican boaters more with the implementation of rafting mooring buoys, then it is possible that they will trust and use them.

Because we created our design in SolidWorks, we recommend that a professional mechanical engineer performs simulations on the rafting mooring design. This would be much more accurate than the calculations we completed. These simulations can more accurately measure the rafting mooring design's strength.

Another recommendation for the DRNA is to conduct field testing on the rafting mooring design. This involves constructing the actual design and having boaters attach to the system while rafting. One possible field testing location that was mentioned was Boquerón. Results from the second survey showed that if boaters see a demonstration of the rafting mooring being used, then they would feel more comfortable using it. We realized that boaters are not aware that current mooring buoys are regularly maintained. We also found out that maintenance differs by region as some mooring sites are used more often than others. Therefore, we recommend that the DRNA's current maintenance plan should be transparent and communicated to the public. In order to do this, we recommend creating an app for electronic devices that has the GPS locations all of the mooring buoys. With each mooring buoy, the DRNA can update the last time each mooring buoy was inspected. If repairs were completed, the app can specifically describe which parts were repaired or replaced. Along with this app, we recommend that the DRNA creates a map of all of

the mooring buoys around Puerto Rico. This map can be downloaded online, or can be printed off as a brochure so boaters know of all of the locations of the mooring buoys. Then, perhaps, mooring buoys will be used more often.

Despite the fact that there are still many steps to take in this project, the rope design seems to be a great option for the Puerto Rican cays. It has the potential to be easy to use. It would also be relatively easy to install and maintain. Most importantly, the rope design is inexpensive yet still has a high overall strength.

1.0 Introduction

In 2008, more than 500 million people worldwide relied on coral reefs for food, building materials, coastal protection, and/or income produced from tourism (Wilkinson, 2008). Apart from providing fish habitats and a number of goods and resources, coral reefs also have a great deal of economic importance, and there is much to be gained from protecting them. The economic worth of coral reefs is estimated to be 30 billion dollars per year (Cesar et al, 2003).

Unfortunately recent trends predict that 15% of the world's coral reefs are under serious threat of joining the 'effectively lost' category within the next 14-24 years, and 20% of reefs are under the threat of being completely lost within the next 14-34 years (Wilkinson, 2008). When a coral reef becomes effectively lost, it can no longer produce resources or survive, although the coral reef may not be physically damaged at all. The coral reefs' decreasing numbers and the lack of coral reef recovery is caused by human activities such as: overfishing, pollution, sedimentation, and development. Aside from human factors, the rising frequency of hurricanes and tsunamis are also detrimental to coral reefs. Damage is especially prevalent in the Indian Ocean, West Pacific, and the Caribbean. Coral reefs that live on the coasts with large human populations are also at a high risk. Overall, it has been estimated that 19% of the original coral reefs are effectively lost; whether it be that the reefs were physically destroyed, or polluted to the point where they can no longer survive (Wilkinson, 2008).

Puerto Rico, like other places in the Caribbean, is suffering from a high level of dying coral reefs and other important marine life, such as seagrass. Aside from pollution, coral reefs are being physically damaged by anchors used during recreational boating, especially around the cays. Anchors can break the corals, which prohibit them from providing food and a safe habitat for other marine life.

There is a plethora of organizations dedicated to protecting coral reefs and the environment they nurture. Many campaigns have been created to aid the coral reefs' recovery such as the 'International Coral Reef Initiative'. The Departamento de Recursos Naturales y Ambientales (DRNA) also works to protect and restore the ocean ecosystem. This project helped the DRNA to reduce marine habitat damage caused by anchors in the Puerto Rican cays. However, there are still many issues that need to be addressed. The habits of the boaters are a major concern. Many boaters in Puerto Rico are involved in the practice of "rafting", where multiple boats are tied together and must anchor to remain stable.

This issue has already stirred up some concern. Researchers have been trying to better understand the extent of the damage and figure out ways to solve this problem. To help limit the amount of damage in Puerto Rico, the DRNA has installed more than 300 moorings around the island (Bouchard et al., 2013). The purpose of these moorings is to eliminate the necessity for vessels to anchor, limiting damage done to coral reefs and other underwater habitats. Previous research by Bouchard et al (2013) focused on cataloguing the utilization of the buoys and evaluating the condition of surrounding underwater ecosystems. It was found that the seagrass and coral reef environments surrounding Puerto Rico are in various stages of recovery. The previous research team found that there were a lot of bare patches caused by anchor damage from recreational boats scattered among the recovering plants. Bouchard et al. (2013) recommended that a solution to this problem would be to encourage more mooring utilization by implementing a rafting mooring buoy.

The goal of this project was to design a rafting mooring buoy in order to aid the DRNA in its efforts to stop physical and ecological damage caused by anchors. This was accomplished by gathering existing knowledge of benthic communities and boat securing devices. Next, we created multiple 2D designs of rafting moorings. We then gained feedback on our designs, and used a value analysis to select the most feasible design to be implemented in Puerto Rico. We created a 3D visual of our final design in SolidWorks, in order to have model that could be used for simulations in the future. Finally, we made a strategic plan to implement and promote our design.

2.0 Background

Coral reefs and other important marine life have a large impact on the ocean ecosystem and the entire biosphere. However, are being severely damaged in the cays of Puerto Rico due to the use of anchors from local boaters. This chapter explains the essential background information in order to gain further understanding about our project. This section first addresses the biological characteristics of coral reefs, mangroves, and seagrass, and how their populations are steadily decreasing. The status of these species is then observed, specifically in Puerto Rico, along with the current anchoring policies, and structure of boat securing devices. A summary of a previous research project completed by past Worcester Polytechnic Institute (WPI) students is then given. The project provides research on current moorings in place and assesses the damage to coral reefs around the Puerto Rican cays.

2.1 Ocean ecosystems

There are many different species in the ocean ecosystem that provide food, shelter, and other resources for marine life. These species help contribute to the vast amount of biodiversity in the ocean. Without these species, the ocean would not be able to sustain itself the way it currently does. In this section, the principal attributes of marine life and how they are being damaged in Puerto Rico are researched.

2.1.1 Coral reefs

Coral reefs are considered to be one of the most diverse marine ecosystems. Coral reefs are in the entozoan's class within the phylum, Cnidaria. Coral reefs are found in the shallow ocean floor, since they need sunlight to perform photosynthesis (Ocean Portal, 2013). Roughly 25% of marine species depend on coral reefs, for food, shelter, or both, even though coral reefs only cover less than 1% of the ocean floor. They are important for marine life and for people. Coral reefs attract fish and other marine life, which makes a great tourist attraction. Additionally, they help sustain the diversity of the ocean ecosystem which allows people to fish for food (Ocean Portal, 2013).

Interestingly enough, coral reefs also provide resources found in pharmaceutical products. They are not only important sources for medicines used in treating cancer, Alzheimer's disease and various heart diseases, but also used in aesthetics such as cosmetics. Curacin A, found in the coral reefs, is a substance that has anti-cancer properties. Biologists have also found that proteins

in Curacin A also have key roles in hormone synthesis, gene regulation and antibiotic resistance. Another product, Dolostatin 10, is also under clinical trials for treating liver and breast cancer, tumors and leukemia. The coral *Pseudoterigorgia elisabethae* naturally produces a product with anti-inflammatory and analgesic properties (Bruckner, 2013). Furthermore, coral reefs also boost tourism. The beauty of coral reefs attracts visitors which consequently generates revenue and helps the local economy. According to World Wide Fund (WWF), tourists visiting Florida Keys in the United States generate at least \$3 billion dollars in annual income, and Australia's Great Barrier Reef generates about \$1 billion per year. If coral reefs are properly conserved, they can keep bringing in revenue to the local community (Harvey, 2013).

Unfortunately, their numbers are diminishing at a rapid rate due a variety of factors including overfishing, pollution, and fragmentation. Coral reefs are already very fragile organisms, and most only grow a small fraction of an inch every year. Therefore coral reefs are often not able to recover from the increased pollution in the ocean. The levels of carbon dioxide in the ocean have dramatically increased, causing coral reef bleaching. During bleaching, coral reefs literally turn a white color and die. Most of the damage to the coral reefs is caused either directly or indirectly by humans (Ocean Portal, 2013). Figure 2 is a comparison of healthy and unhealthy coral reefs.



Figure 2: A healthy coral reef vs. an unhealthy coral reef (Coral Reef Care, 2011).

A coral reef is distinguished as healthy if it has a variety of colors. Any dull colors present are a result of coral bleaching or fragmentation. It is important to note that just because a coral

reef is bleached or losing its color does not mean that it is dead. However, it puts the coral reef under a lot of stress which often results in death.

2.1.2 Mangroves and seagrass

Mangroves are a collection of trees and shrubs that live on the oceanic coast. They thrive in extremely hot, sticky, and muddy conditions where most plants could not survive, which make them extremely unique. Their roots are quite distinctive. Not only are they submerged in the ocean, but they also branch up and out where roots are not normally seen. Mangroves, like coral reefs, are also hosts to a wide variety of marine life. They even contain species unique only to mangroves. Mangroves are very important for the biosphere. They produce wood, food, and medicines, and also build land without causing runoff into the ocean, which improves water quality (Mangroves, 2013). Figure 3 shows what a mangrove forest looks like.



Figure 3: A photograph of common Mangroves (Mangroves, 2013).

Seagrass is very abundant in the Gulf of Mexico and around Central America. Like mangroves, many marine species lay their eggs in seagrass because the eggs will be hidden. It is the home to several species of algae, bacteria, and plankton. What makes seagrass so important is that they provide oxygen for the ocean, and extract nutrients from the ocean floor and release them into the ocean. It also provides a home for tiny invertebrates, sea anemones, and fish. Seagrass is also a source of food for larger marine animals like sea turtles. The abundance of seagrass is diminishing, mainly due to runoff from fertilizers and pollution in the ocean. The fertilizers cause algae blooms, which block sunlight and prevent seagrass from photosynthesizing

(Seagrass, 2013). Figure 4 shows a seagrass bed, which looks very similar to regular grass found on land.

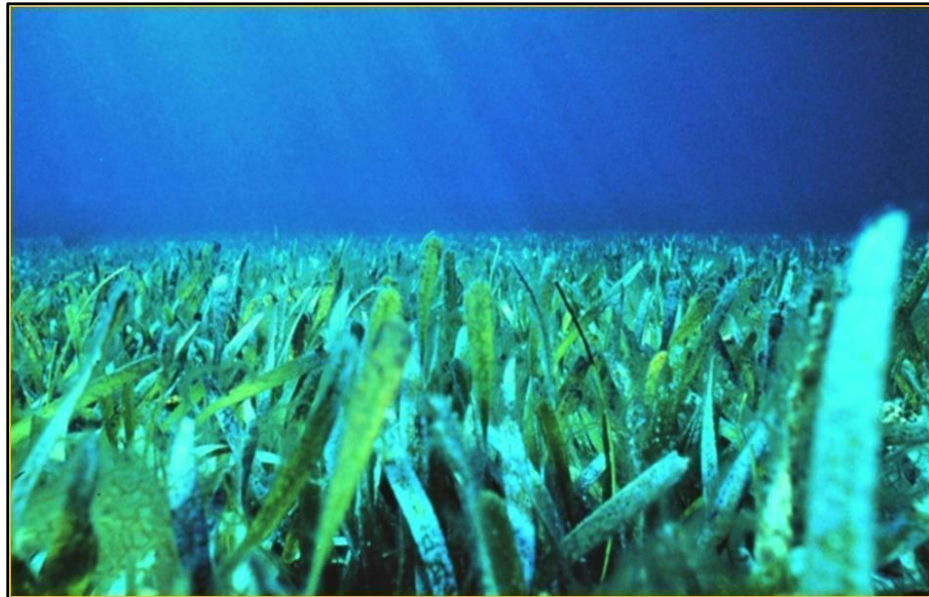

Figure 4: A healthy seagrass bed in Puerto Rico (Batista, 2014).

Seagrass beds and mangroves have a strong impact on the survival of the fish that feed on coral reefs. Many species of fish will spend their adolescent lives living in mangroves and seagrass, but will then migrate to coral reefs once they become adults. A study was completed to compare the densities of 17 different types of fish living in coral reefs versus living in mangroves and seagrass (Nagelkern et al, 2000). Results concluded that for 11 out of 17 breeds, the reefs that did not have this nursery habitat nearby had low densities or complete absence of fish (Nagelkern et al, 2000). Vice versa, these species of fish that do not have coral reefs nearby will also suffer. Both scenarios will tremendously impact the fishing industry.

2.1.3 Status of marine ecosystems in Puerto Rico

Most of the coral reefs found in Puerto Rico are located in the south, east, and west coasts. On those coasts there are smaller, uninhabited islands that are abundant with coral reefs. Off the east coast, there are the islands of Culebra and Vieques and off the west coast; there are the islands of Mona, Monito, and Desecheo (Causey et al, 2002). Figure 5 shows a map of Puerto Rico, including its surrounding islands.



Figure 5: A map of Puerto Rico and the surrounding islands (Max Energy Limited, 2009).

Figure 5 shows Culebra (Isla de Culebra) and Vieques (Isla Vieques) on the east coast. Desecheo (Isla Desecheo) and Mona (Isla Mona) are represented on the west coast. Monito (Isla de Monito), although not labeled, can be spotted on the map as the tiny island off of the Isla Mona.

The two islands off the east coast, (Culebra and Vieques) are almost completely covered by coral reefs. In total, coral reefs cover roughly 3,370 square kilometers within 3 nautical miles of the coast. This accounts for 3% of the total coral reef area in the United States (Causey et al, 2002). The most common type of coral reef in Puerto Rico is the fringing reef. Fringing reefs are the most common type of reef in the world, and are known to grow close to the coastline, specifically around continents and islands. Small, shallow lagoons separate these reefs from the shoreline. Overall, the status of coral reefs in Puerto Rico is one of the most critical in the entire Caribbean. This is due to a combination of accelerated urban development, and a lack of effective management over the past 40 years. Along with the decline of coral reefs in Puerto Rico, mangroves have been getting cut and cleared out as well (Causey et al, 2002).

As mentioned earlier in the chapter, many species of fish that live in coral reefs as adults live in mangroves when they are young. If mangroves are not present around coral reefs, then the coral reefs will not attract many fish. In Puerto Rico, sometimes boaters will tie their boats to the

roots of the mangroves instead of dropping anchor. This causes the roots to break which leads to the death of the mangroves. Breaking these roots negatively affects the birth of fish species that live within the mangrove roots. Since mangrove roots produce seeds, mangroves will not be able to replenish once they die. Sediment from the ocean floor will also be removed when mangroves roots break (Bouchard et al, 2013).

2.1.4 Damage caused by anchors

In Puerto Rico, boats are used for socializing, fishing, and transportation. It is a very important part of their culture. A wide variety of boats of many sizes are used by the local people. Most of the boaters use anchors to hold their boats in place when they are idle. People drop their anchors when fishing or just socializing with other boats. When anchors drop, it can damage marine life that is on the ocean floor. It is difficult for boaters to avoid crushing marine life because they cannot see very deep in the ocean.

Many of the important functions of the ocean ecosystem are being damaged by anchors used by local and commercial boaters. There are three stages of anchoring when coral reefs may be damaged. These stages are dropping of the anchor, dragging of the anchor on the seafloor, and retrieval of anchor (Dinsdale & Harriott, 2004).

First, the anchor drops from the boat onto the infrastructure of the reef. This causes corals to become fragmented, broken, or inverted. While at anchor, the chain may drag across the reef, or wrap around it causing further damage to the coral reef (Dinsdale & Harriott, 2004). Lastly, the anchor is retrieved back to the boat. Inversion may take place if the anchor is wedged under a coral reef. The odds of this happening increase if an electronic winch (mechanic device to bring the anchor back up) is used instead of pulling up the anchor by hand (Dinsdale & Harriott, 2004). Figure 6 illustrates what a broken coral reefs looks like.



Figure 6: Broken corals caused by physical damage (National Oceanic and Atmospheric Administration, 2010)

This could have been caused by anchors or some other form of physical damage. Some of the broken coral will actually reattach themselves naturally, but most will remain fragmented on the ocean floor (National Oceanic and Atmospheric Administration, 2010). High fragmentation leads to the overall death of coral reefs.

A case study at the Florida Keys was conducted to evaluate the extent of damage of boaters. The study involved the Carysfort Reef, which has high levels of boating activity, and other nearby reefs that have less boating activity. The results showed that the Carysfort Reef has higher intensities of broken and fragmented corals compared to the nearby reefs that do not have such a busy boating area (Dinsdale et al, 2004). A similar study was completed to assess the amount of physical damage to seagrass and coral reefs in twelve specified areas in the Puerto Rican cays. It was found that areas that have the most frequent use of boats had the most physical damage, including fragmentation and inversion (García-Sais et al, 2008). Although it is difficult to assess the exact damage done to the reefs by anchors, it is safe to assume that as long as boaters continue to drop their anchors; this physical damage will continue to happen, especially in places that have high boating traffic. Anchor damage can be prevented by creating a unique and low-cost alternative to anchors, such as rafting mooring buoys.

2.2 Boat-securing devices

It is necessary for boats to be secured when floating idly in water. Otherwise, currents and winds would relocate the vehicles where they could get lost. If the boats were occupied at the time, the occupants would constantly have to worry about moving their boat back to an area appropriate for engaging in activities such as fishing, socializing, or just enjoying a day on the water. In this section, three different securing devices and their current usage will be explored.

2.2.1 Boat anchors

Boat anchors are the most common of all boat-securing devices. They are simply a metal body attached by chain or rope to the bow of a boat. This allows for boaters to quickly secure their boats by dropping the anchor off the boat onto the ocean floor. Boat anchors come in different shapes used for varying conditions. The most frequently used one is the fluke anchor (USPS, 2011). The flukes, as seen in Figure 7, dig into the ocean floor as they drag across it. This means the boat will not drift very far before the anchor stabilizes. These flukes can also get caught on coral reef structures and tangled in seagrass, making them very dangerous to use in areas that contain these life forms.

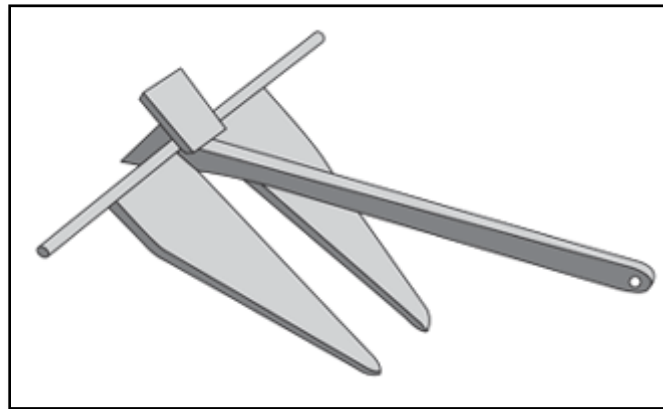

Figure 7: Fluke Anchor (USPS, 2011).

2.2.2 Moorings

A mooring is a device to keep boats in place while floating in the water. They prevent the boats from drifting in currents and allow them to stay in one general area without having to drop their anchors. The DRNA has already installed several mooring buoys around Puerto Rico (Coffey et al, 2009). Moorings are a great alternative to anchors and will not damage marine life

when used properly. All moorings have the same general structure. Table 1 shows the different parts of a mooring buoy and their respective functions, and Figure 8 shows the mooring buoy as a whole, including labels of all its parts.

Table 1: The parts of the mooring buoy

Part	Purpose
Embedment metal anchor	To keep the buoy/boat in place; embedded in ocean floor
Down line	Chain or rope that connects the anchor to the throughline
Throughline	Rope that connects from the down line, through the buoy, to the attachment line
Buoy (flotation device)	Floating object that makes the system visible; can vary in size or color
Attachment line	Rope that boaters use to attach to the mooring

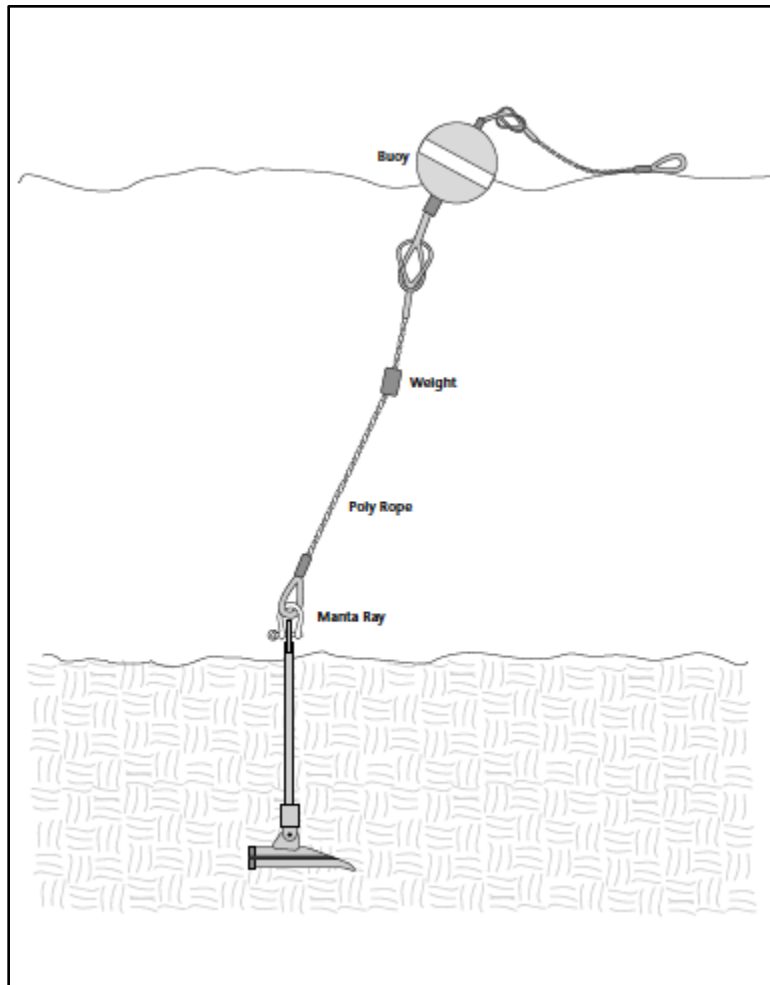

Figure 8: Mooring Buoy (National Oceanic and Atmospheric Administration, 2005)

There are three different sections of rope that connect each part of the mooring together. These ropes can be seen in Figure 9. First is the pickup, or attachment line, which is what boaters use to attach their boat to the mooring. The attachment line is connected to the throughline that goes through the middle of the buoy. This line then connects to the down line, which runs from the buoy to the anchor. The DRNA uses specific types of rope for each section of their moorings in Puerto Rico. Specifics about these ropes can be seen in Appendix J and K.

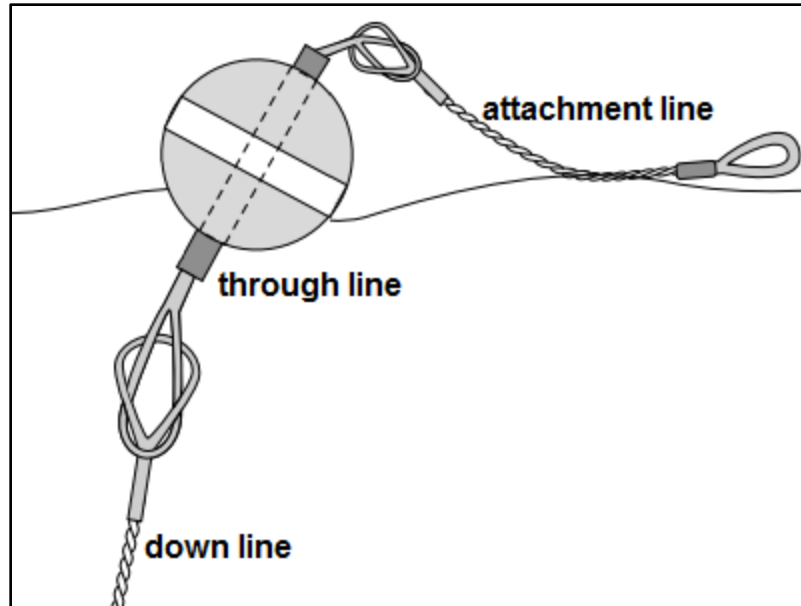

Figure 9: Different lines required for a mooring buoy (National Oceanic and Atmospheric Administration, 2005)

There are different designs for an embedment anchor, shown in Figure 10. Each design has a different maximum weight it can sustain and are useful for mooring a variety of vessels. The specific type of embedment anchor used is normally determined by the characteristics of the seafloor which it is being anchored into. The DRNA used the Manta Ray anchors for to embed the moorings that they installed around Puerto Rico (Bouchard et al, 2013).

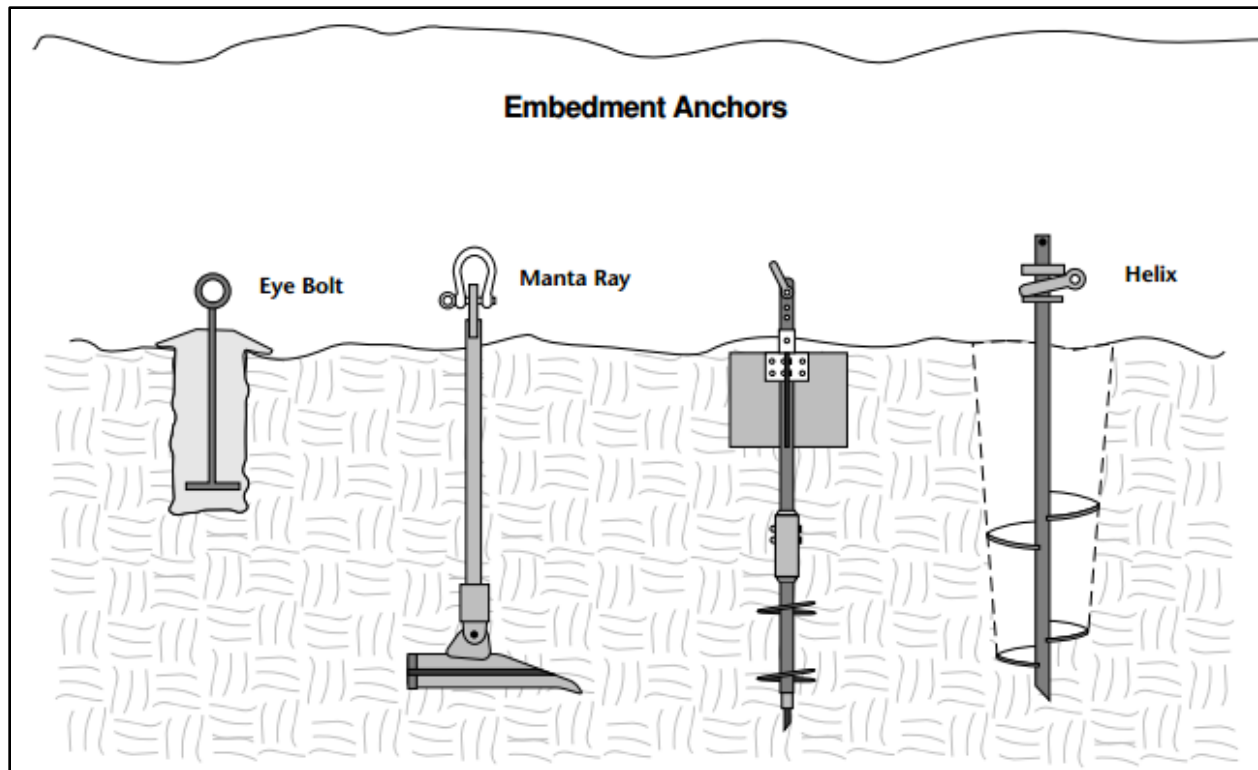

Figure 10: Types of mooring embedment anchors (National Oceanic and Atmospheric Administration, 2005).

Manta Ray embedment anchors were originally designed for keeping utility poles in place, and were modified for use in mooring structures (National Oceanic and Atmospheric Administration, 2005). As seen in Figure 10, Manta Ray embedment anchors are composed of a thimble eye bolt, an anchor rod, and rotating wing. The eye bolt (on the far left) is exposed to the water and is the attachment point for the rest of the mooring. The anchor rod extends into the ocean floor. Anchor rods are available in 3½ foot and 7 foot lengths; the longer rods have a stronger holding capacity (National Oceanic and Atmospheric Administration, 2005). Installation of Manta Ray embedment anchors is quick and simple. Using an underwater jackhammer, the embedment anchor is driven into the sea floor until the anchor rod is below the surface. A device called a load locker applies an upward force, pulling on the anchor rod until the wing rotates horizontally and locks into place (National Oceanic and Atmospheric Administration, 2005). Due to the sediment on the floor of Puerto Rican cays, the ease of implementation, and the strength of the embedment anchor, the Manta Ray was seen as the best choice for the mooring buoys in Puerto Rico.

In 2013, there were almost 270 moorings installed by the DRNA around the island of Puerto Rico to prevent anchors from causing ecological damage (Bouchard et al, 2013). These were placed in cays and high traffic boating areas with sensitive benthic ecosystems, in hopes that they would be used as an alternative to anchoring. However, these structures are not being utilized, or are being utilized incorrectly, and damage due to anchors is still occurring (Bouchard et al, 2013). A possible solution found was to create a rafting mooring buoy.

2.2.3 Rafting mooring buoy

Rafting is a common activity among boaters. It occurs when boats are tied hull to hull in order for boaters to easily interact without worry of floating apart. Along with tying together, each boat will normally drop anchor or attach to a mooring and drop anchor to secure their boats. This clustering of anchors can be incredibly destructive to marine life below the surface. An alternative to this would be a rafting mooring buoy. Figure 11 shows the proper demonstration of how to use a mooring buoy, while Figure 12 shows rafting behavior in Culebra, a small island off the Eastern coast of Puerto Rico.



Figure 11: The correct way a boat latches onto a simple-structured mooring buoy (National Park Service, 2014).



Figure 12: Rafting behavior seen in Culebra (DRNA, 2013).

A rafting mooring would be composed of two or more regular moorings attached by a chain or cable. Boats would be able to hook to the cable by attachments placed incrementally along its length. This structure would provide more stability than a regular mooring buoy, so anchor usage while rafting would not be necessary.

2.3 The F-27 Project

The F-27 project was created and executed by a team of DRNA staff in order to reduce the damage to the local marine ecosystem in Puerto Rico. The objectives of this project were:

1. To protect and promote restoration of marine life by installing ecological mooring buoys
2. To determine the regions that required buoys and assess these areas on the sediment of the sea floor to select the proper anchor for implementation
3. To obtain all necessary permits and materials needed to install the mooring buoys
4. To maintain the entire mooring buoy for the duration of the project (DRNA, 2006)

This is an ongoing project, in which the condition of moorings and marine life, such as coral and seagrass, are documented in yearly segments. During each of these segments, aerial photographs are used to determine changes in patterns of boat traffic, in order to see if the number of moorings in an area is appropriate to accommodate the average number of boats in the area, or if moorings need to be relocated. In the most recent segment of the project (April 2013-March 2014), the place with the most average boat traffic, observed over three-day weekends, was found to be Icacos, Fajardo.

These photographs can also be used to keep track of restoration of marine life, as shown in Figure 13, where the scarring of seagrass beds can be seen.



Figure 13: Scarring of seagrass in Matias Cay in Salinas (DRNA, 2006)

Maintenance teams from the DRNA are responsible for examining moorings in place and determining if cleaning or replacement is necessary. Mooring lines and buoys often wear down from overuse, but the mooring anchors are only replaced when they get fatigued from misuse (DRNA, 2006). Both Manta Ray and Halas anchor were used due to the different sediments on the seafloor. Manta Ray anchors were used in areas with softer substrate, and Halas anchors were used in areas with harder substrate. There are currently 320 moorings in place around Puerto Rico, and the number is rising as the F-27 project continues (DRNA, 2013).

2.4 Current mooring buoy systems around the world

Mooring buoy systems do not only exist in Puerto Rico. In fact other countries around the world, including other areas in the Caribbean, have also installed mooring buoys to protect marine ecosystems. These locations include the British Virgin Islands, the United States Virgin Islands in the Caribbean, as well as France. This section describes some of the other mooring buoy systems and more specifically the rules and limitations in place to ensure that the mooring buoys are used properly. All of the information in this section was obtained from guides available online. The purpose of these guides was to inform and educate the boaters and the general public about

mooring buoys. In addition to these guides, overall designs were also researched because there are a variety of possible designs that can be used.

2.4.1 United States Virgin Islands

In 1956, the United States Virgin Islands (USVI) National Park was formed by Congress. Its goal is to preserve the cultural and natural resources located around St. John. In 2001, President George Bush officially proclaimed 12,708 acres of submerged lands surrounding the Virgin Islands as the Coral Reef National Monument. This brought the total acreage of the USVI National Park to well over 18,000 (National Park Service, 2014). It is proclaimed a Biosphere Reserve by United Nations Educational, Scientific and Cultural Organization (UNESCO), as it incorporates the values of UNESCO's Man and Biosphere Programme. The USVI National Park created a guide specifically for the boating public called the *Mariner's Resource Protection Guide*. The guide is designed to provide information about the importance of their local marine life, along with instructions on how to safely use the mooring buoys and anchors and when it is applicable to use them (National Park Service, 2014).

The park has always been a very large attraction for boaters. During the 1980s, there was a large increase in the number of boats around the National Park. This resulted in heavy damage to coral reefs, seagrass beds, and algal plains due to the anchors and anchor chains of the boats. These marine organisms are a few of many attractions that tourists travel to the USVI to admire and enjoy. When managers at the park started to notice damage to these organisms, they began to investigate the extent of the damage and what could be done to prevent this damage. The research included reaching out to the local community to ask for their advice and aid. As a result, the park installed over 200 mooring buoys in the bays around St. John, and designated special protection around the more sensitive coral reef and seagrass areas (National Park Service, 2014).

The mooring buoy systems in the USVI National Park have specific laws and policies. The mooring buoys installed by the National Park Service (NPS) have all been load tested with an upward pull of 11,000 pounds. However if the wind speeds exceed 40 mph, then the mooring buoys cannot be used and the vessels must anchor. The guide provides step-by-step instructions on how to properly moor a boat, which includes overnight use. Figure 14 has the instructions given.

How to Moor Your Boat

Fee for overnight use.

- 1) Approach the mooring painter line (pickup line with small surface float) by heading into the wind or current at a very slow speed. Shift engine into neutral before reaching the mooring.
- 2) Pick up the eye of the mooring painter with your boat hook.
- 3) Thread your bowline through the eye-splice of the painter line twice, or thimble once, to prevent chafing. Do not tie off eye at the boat stern.
- 4) Bring your line back to the boat and cleat it off on the same side. DO NOT put the painter line eye over your bow cleat.
- 5) When leaving a mooring, back away with the wind after casting off the painter line.

When using a mooring, do not use an anchor or additional ground tackle. Rafting with other boats is not permitted while occupying NPS moorings.



Jack Hopkin/Inr

Proper approach and pickup of mooring.

Figure 14: The instructions given in the guide on how to correctly moor a boat (National Park Service, 2014)

The mooring buoys are for both day and overnight use. Day use is free while overnight use (between 5:00 PM - 7:30 AM) costs \$15 per night. All vessels must use mooring buoys if the vessels are of a specified size. There are vessel size limits associated with anchor and mooring buoy usage on both the north and south shore of the USVI. Table 2 shows the vessel size limits for mooring buoys on the north and south shore.

Table 2: Size limits for mooring buoys around the USVI (National Park Service, 2014)

Length of Deck	North Shore	South Shore
12 feet or less	May anchor only in sand and not within 200 feet or a mooring field	May anchor only in sand and not within 200 feet or a mooring field
13 to 60 feet	Must use mooring if available	Must use mooring if available
61 to 125 feet	Prohibited from using moorings - must anchor in sand 200 feet seaward of mooring field	Prohibited from mooring or anchoring
126 to 210 feet	Prohibited from using moorings - must anchor in sand at Francis Bay 200 feet seaward of mooring field (at depths greater than 50 feet) and shoreward of a line drawn from Mary Point	Prohibited from mooring or anchoring
Greater than 210 feet	Prohibited from mooring or anchoring	Prohibited from mooring or anchoring

If all moorings in a specific bay are occupied, then anchoring is allowed as long as it follows the NPS regulations (National Park Service, 2014). The following are regulations made by the NPS about anchoring in the USVI:

1. Anchors, anchor chains, and anchor lines may only be dropped in sand
2. No vessels may enter in 'Boat Exclusion Areas'; these areas are designated by white, oval-shaped buoys that clear state "NO BOATS" and/or an orange diamond with orange cross in it, which is the international "boats not allowed" symbol (see Figure 15)
3. Anchoring is prohibited anywhere along the south side of St. John and in Virgin Islands Coral Reef National Monument except for dinghies under 12 feet due to the high volume of coral reefs
4. Boats may not anchor anywhere in the Dinghy Channels; channels are only used to pay for mooring fees or to transport people (pick-up or drop-off)
5. Boats may not anchor within 200 feet of any mooring buoy, 100 feet from any regulatory buoy, or closer than 100 feet to any of the park beaches, (National Park Service, 2014)

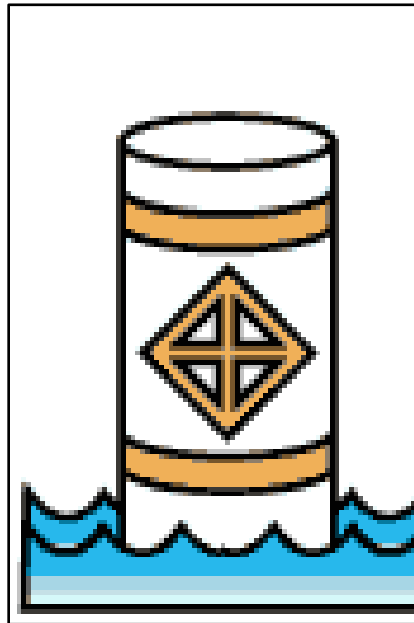

Figure 15: The international symbol that means "boats are not permitted here" (Skipper Online Services, 2014).

Anchoring should only be used when mooring buoys are not available; the vessel is not within the appropriate size, or during emergency situations. There is no fee for using anchors like the fee given to use mooring buoys. The *Mariner's Resource Protection Guide* gives step-by-step directions to use both anchors and the mooring buoys. When occupying the NPS mooring buoys, boaters must never use an anchor or other ground tackle or raft with other boats (National Park

Service, 2014) The guide also includes step-by-step instructions on how to safely anchor a boat. Figure 16 has these instructions.

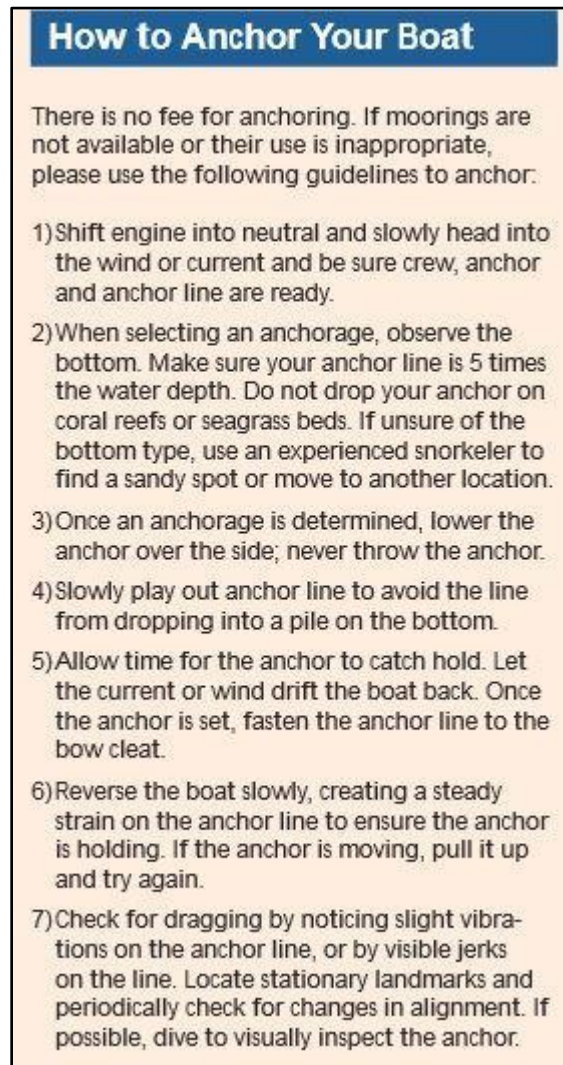

Figure 16: The instructions given in the guide on how to properly use anchors (National Park Service, 2014).

Also included on the guide is a map with the locations of all mooring buoys and anchoring areas. The map includes the names of the bays where the mooring buoys are located, the number of moorings in each area, and whether overnight use is permitted at each specific mooring buoy. It even shows where coral reefs are present (National Park Service, 2014). Figure 17 shows the map with all of these references.

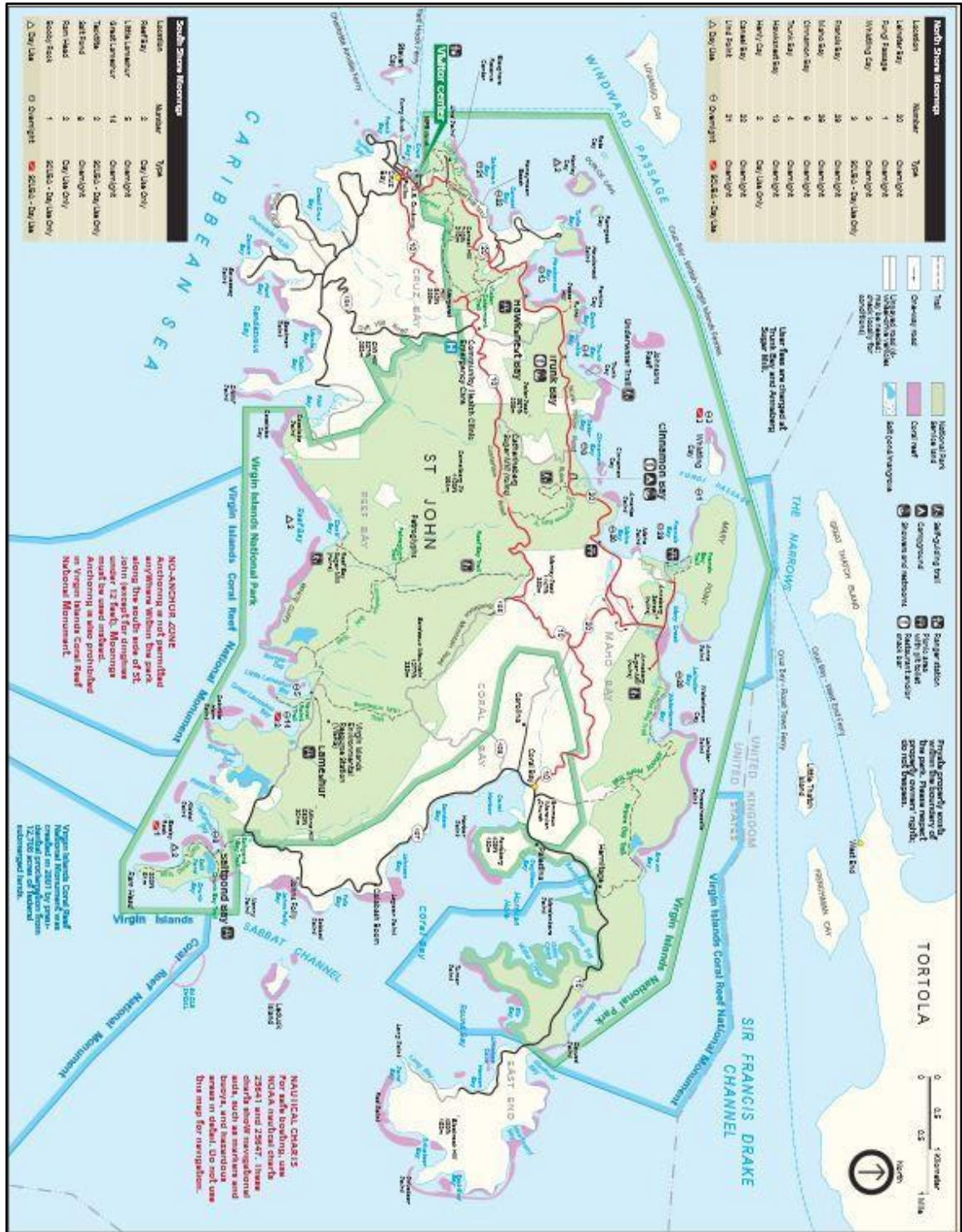

Figure 17: A map of the USVI with locations of mooring buoys and coral reef hot spots (National Park Service, 2014)

There are different color mooring buoys that designate different uses of the mooring buoys. They can be white, blue, or orange, but all buoys have a blue reflective stripe for better identification. White buoys may be for day use only or may allow overnight use. A map of all of

the moorings specify which white buoys are just for day use, and which white buoys are for both day and overnight use (see Figure 17 above). Blue buoys are not for public use, and are reserved for commercial vessels. Lastly, orange buoys are reserved for scuba divers, meaning that people may park their boats on these mooring buoys while scuba diving. Overnight use is not permitted on the orange buoys (National Park Service, 2014).

2.4.2 British Virgin Islands

The British Virgin Islands (BVI) also have mooring buoys located throughout the islands, installed by the BVI National Parks Trust (NPT). The buoys are available for both day and overnight use. In order to use any of these mooring buoys a permit must be obtained from the NPT. A small fee is collected when a permit is obtained, which goes towards the implementation, maintenance, and repair of the mooring buoys. Like the mooring buoys in the USVI, the mooring buoys in the BVI are color coordinated according to use. Yellow buoys are for commercial vessels and divers (Moorings, 2011). Red buoys are reserved for snorkelers only, and blue buoys are for dinghy dock lines. Step-by-step directions are also available to boaters so that neither the boat nor the mooring buoy is damaged during the mooring process (BVI National Parks Trust, 2011). The steps to moor are:

1. Approach the mooring buoy slowly with the bow of your boat into the wind with your dingy pulled on a short line.
2. Have a crew member ready with a boat hook at the bow to direct you and to pick up the mooring pennant.
3. You may find that at idle speed by shifting alternately from forward to neutral you can coast to the buoy, then shift into reverse for a second to stop the boat as the crew member lifts the pennant on board and attaches it to the bow cleat.
4. Please do not be embarrassed if you miss picking up the pennant for the first time. It happens to all of us at some time. Just circle around make another approach. Please do not extend the length of the pennant.
5. To leave the mooring with your dinghy once again on a short line simply let go the pennant and set off for your next destination. Take care not to run over the mooring buoy and pennant as you leave.

The BVI also has also a flag system that indicates when it is appropriate to use the mooring buoys specifically at the Baths National Park. This is dependent on weather and oceanic conditions. Green means it is safe to use the buoys, yellow means the buoys should be used with caution, red means the buoys should not be used, and blue means that there is a high concentration of jellyfish in the area. The blue flag is especially important for the snorkelers and divers so that they are not stung (Protection Programs, 2011).

The guides for both the BVI and the USVI are very helpful for the boating community, especially the guide for the USVI. It provides information on why the mooring buoys are there, where the mooring buoys are, and other important information. This information makes it clear when and where it is acceptable to use the mooring buoys.

2.4.3 Other mooring buoy designs

A company in France has created their own unique version of a mooring buoy design. This is patented as the WaterLily, designed by ACRI-In products in France (Design & Build, 2014). Figure 18 is a representation of the WaterLily being used in the ocean. Figure 19 is a computer-aided design of the WaterLily that shows all of the parts with labels. Because the labels are in French, the company was contacted to complete a table with French to English translations is given in Table 3 for clarification.



Figure 18: The WaterLily rafting mooring (ACRI-In, 2014).

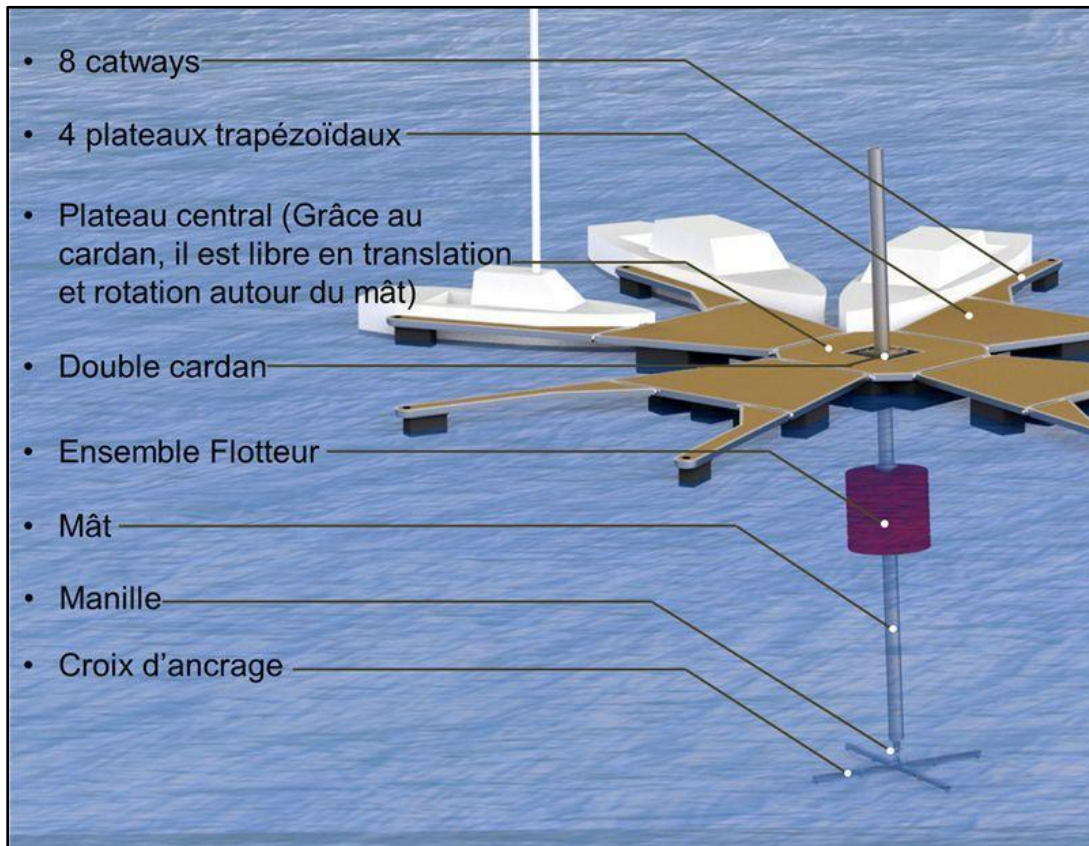

Figure 19: A computer-aided design of the WaterLily rafting mooring with labels of each part (ACRI-In, 2014). See Table 3 for English translations.

Table 3: A French to English translation of the specific parts of the WaterLily (ACRI-IN, personal communication, 2014)

French	English
Catways	Catways
Plateaux trapézoïdaux	Trapezoidal-shaped plates
Plateau central (Grâce au cardan il est libre en translation et rotation autour du mât)	Central plate (rotation and translation free around and along the pole axis thanks to the cardan system)
Double cardan	Double cardan system (equivalent to ball-joint + slide link)
Ensemble flotteur	Floating system
Mât	Pole
Manille	Clevis link (ball-joint like link)
Croix d'ancrage	Anchoring cross

This design is unique because it is in a cross-shaped formation. The WaterLily is built to secure multiple boats that can raft together and allow people to socialize among boats without using anchors. The platforms are in the shape of trapezoids where people may stand or sit if desired. The trapezoidal platforms are specifically made to fit larger boats. The empty space between the trapezoids can fit two smaller boats. Only one anchor is needed in the center to support the entire structure, which is attached to a long pole or mast. As an additional benefit, scuba divers, windsurfers, and snorkelers can also use the platforms if they want to rest or socialize with people on the boats. The platform is able to freely sway with the wind and the waves of the water without causing any additional tension to the pole and anchor. The WaterLily also will not stiffen up because chains are not used, and the platform will always be cushioned when waves come through the system. Another advantage of the WaterLily, compared to other mooring buoys, is that it is easy to take apart and store when the weather becomes poor and the system is temporarily not needed. This saves a lot of money on repairs and overall maintenance of the structure (ACRI-In, 2014).

Although this solution may be feasible for Puerto Rico and other areas of the world, the company (ACRI-In) does not provide the public with any additional information regarding costs

and other important factors that would need to be considered when evaluating the design's expediency. The WaterLily is still in the developmental process. However, the overall structure for this design can still be considered as a possible solution for the needs of Puerto Rico.

2.5 Political and social aspects of boat anchors and mooring buoys

In addressing any problems having social implications, it is very important that a partnership exists between the major stakeholders (Olsen et al, 2000). It is important that the people initiating social change and the people who are affected by it move forward in a collaborative path. Then a relationship of trust and mutual interest can be built in which all the stakeholders are taken into consideration.

In Puerto Rico, despite the damage caused by anchorage, boaters continue to use anchors to park their boats. Boaters that are aware of the policies still anchor in the sand of the beach to avoid fines for dropping anchor on the coral reefs. This practice erodes the beaches and is discouraged by the DRNA (Coffey et al, 2009). This section will illustrate the different anchoring policies in place, and residents' demeanor towards them.

2.5.1 Current anchoring policies and their enforcement

Article 8, Clause 4, of Law 147 of the Commonwealth of Puerto Rico states that, "Anyone who tries to anchor, fix, install, or in any other way stop a vessel outside the anchoring buoys in areas identified by anchoring buoys or any other floating signal, or within duly identified special designation areas, or reef recovery areas and ecologically sensitive areas..." (Puerto Rico House of Representatives, 1999) will be fined a minimum of \$500 to a maximum of \$10,000.

This leaves the law open to individual interpretations as specific violations and their respective fines are not prescribed. Table 4 illustrates how many laws are unclear because certain factors are not considered.

Table 4: Some examples of factors that are not specified in anchoring policies

Factors that may affect the enforcement of law	Example of lack of clarity
Size and type of boat	The bigger the boat, the bigger the size of the anchor.
Time of anchoring	Some forms of anchoring can be banned at certain times of the day.
Turbulence in ocean	In case of emergency, anchorage is allowed.
Location of anchorage	Some areas may require more attention (i.e. more coral reefs) than others.

Unfortunately, important factors like these are not addressed in the law. Furthermore, Bouchard et al (2013) interviewed DRNA maritime rangers who stated that they rarely punish anyone for anchoring boats, for they are unaware of how much they would need to fine boaters for a particular violation (Bouchard et al, 2013).

2.5.2 Attempts to educate boaters

In the past, the DRNA has tried to educate boaters about anchoring laws through various educational programs. DRNA personnel visited different marinas, yacht clubs, boating schools, fishing villages, and boating shops to explain the correct usage of moorings. Brochures, posters, and educational DVDs were also distributed amongst boaters. These materials included different rules to use the moorings, and also they expanded on the damages to coral reefs, seagrass, and mangroves caused by anchors. These materials were also given to the new students who were required to take navigation courses offered by certified organizations all over the island. (Kercado et al, 2010). Bouchard et al (2013), exploring this issue, observed that people generally did not retain information regarding fines. Only 22% of the people who had seen educational materials knew about the maximum fine. The DRNA also has conducted surveys regarding boat-securing methods. To their dismay, only 52% of the sample size reported that they use buoys to secure their boats (Coffey et al, 2009).

2.5.3 Social aspects of the mooring buoy system

Another boating behavior that was observed was the use of the mooring buoys. Unfortunately, the boaters who were using the moorings were doing so incorrectly (Bouchard et al, 2013). For example, many boats were hooked onto one buoy. Buoys are meant to sustain one boat at a time or else the mooring buoy will fail. Multiple boats were also seen tied together hull to hull, increasing the stress on the buoy. Because the buoy can only support one boat, the boaters had to anchor which defeats the purpose of the mooring buoy (Coffey et al, 2009).

The rafting behavior was mainly observed during long weekends and holidays. From years 2007-2010 more than 300 vessels were counted on weekends and holiday seasons. In some areas, the number of boats exceeds the number of buoys as well. This may cause the boaters to engage in rafting while they use moorings. Figure 20 depicts what rafting typically looks like in Puerto Rico. This causes strain on the moorings and can lead to failures (Kercado et al, 2010).



Figure 20: An aerial Photograph of Caracoles Cay in La Parguera Natural Reserve shows the rafting behavior during a weekend of the main boating season (DRNA, 2011)

2.5.4 Social aspects of coral reef protection

There are many social aspects that will need to be considered in order to protect coral reefs. Aside from having the boaters learn the proper use of rafting moorings, an additional challenge will be getting the boaters to want to use them instead of anchors. The boaters must be

educated about the value of coral reefs and seagrass and how it directly impact Puerto Rico. In other words, in order for the rafting moorings to be successful, there needs to be urgency amongst boaters to use the system to prevent damage to marine life.

A case study was completed in five different countries bordering the Indian Ocean to assess the biomass of coral reef fish vs. the socio-economic development of the area. The countries were: Madagascar, Seychelles, Mauritius, Kenya, and Tanzania. Nineteen total fishing sites were examined for their densities of reef fish, and their socio-economic development. Each place of interest was given an index number from -1 through 1.5 based on their social and economic development, with -1 representing very low development and 1.5 representing very high development. The index number was then plotted versus the density of reef fish. Figure 21 shows the results of this study (Cinner et al, 2009).

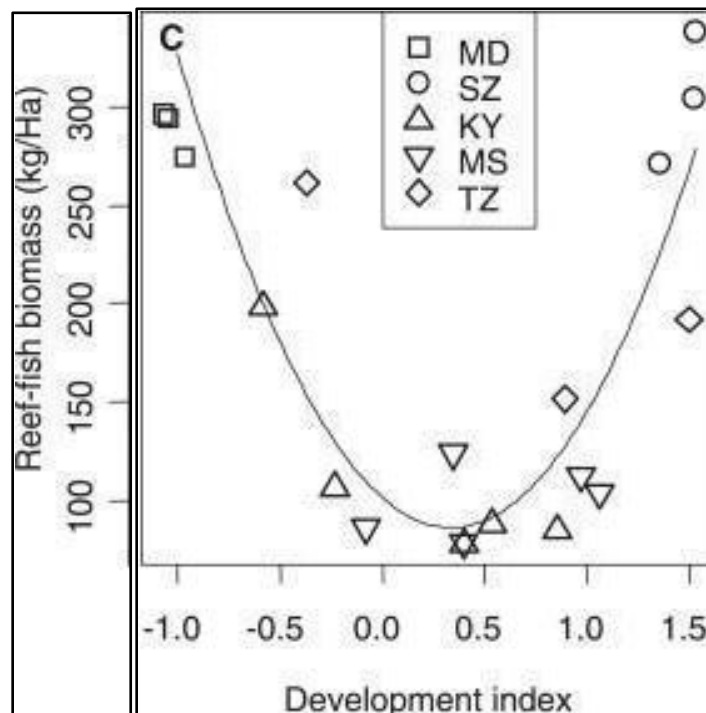

Figure 21: A scatter plot of the socio-economic development index versus the reef fish biomass (Cinner et al, 2009).

Included in the scatter plot is a line of best-fit, which is a quadratic function. Located in the figure is a key that explains which symbols represent the given countries studied. Table 5 below shows statistical analysis for the figure above.

Table 5: A list of statistical traits from the scatter plot above (Cinner et al, 2009)

Name	Description	Variable	Value
Variables	Tells the total number of fishing sites that were examined	n	19
Residuals squared	Shows how accurate the line of best fit is with the actual data; perfect correlation will mean that residuals squared value is 1	r^2	0.77
p-value	Probability of obtaining similar test results as the original null hypothesis; a p value less than .01 means that there's a very strong probability	p	< .001

From Figure 21, the results from the data and the line of best fit demonstrate that the densities of fish are high in places where the socio-economic development is very low or very high, but low in communities with intermediate socio-economic development. The quadratic curve (line of best-fit) is consistent with the Kuznets hypothesis. Kuznets predicted that increasing socio-economic development results in ecological degradation. This will continue until environmental conditions improve within the community as societies become increasingly affluent and begin to demand an increase of environmental quality. So the relationship between affluence and local environmental conditions is in a U-shaped relationship (Cinner et al, 2008).

The low developed populace is characterized by high dependence on fishing as a primary occupation, minimal salary-based employment, low levels of technology, minimal boats with engines, and a weak national government. The high dependence on fishing is due to the fact that it is difficult or very expensive to import other sources. Therefore, people highly depend on fishing as a source of food. The lack of salary-based employment is simply the lack of technological or skill-based companies to work for because the educational system is weak. The rate of employment is also very high. Low levels of technology in low developed communities make the total resources available minimal. The low levels of technology are due to the lack of government funding available. This means that there will not be many boats with engines. This reduces the amount of fishing available, meaning that there will not be a lot of physical damage to marine life.

In summary, communities with poor development are not going to have the resources and technology to fish at high rates or damage coral reef ecosystems. Therefore, marine resources are not exploited and the populations of all species of reef-fish remain high (Cinner et al, 2009).

As for communities of high development, they are characterized by low dependence on fishing, usage of non-damaging fishing gear, high levels of salary-based employment, more advanced technology, easy access to boats with engines, and a strong national government. The low dependence of fishing is caused by a high rate of importation. Food is readily available and abundant, so fishing for food does not occur frequently although people do enjoy catching and eating their own fish. High levels of salary-based employment make the economy stable correlates with a good educational system. Salary-based employment and advanced technology allow people to spend money on more efficient resources that are available. These sources will not cause as much damage to the coral reef ecosystems. Even though engine-based boats are used frequently, they practice sustainable fishing methods, will be able to monitor the fish populations and protect coral reefs so that the fish populations will be able to replenish themselves due to a strong national government. The government makes environmental regulations a priority that will protect all ecosystems. From this, coral reefs will not be as heavily damaged (Cinner et al, 2009).

The communities of intermediate development have traits from both communities of high and low development. They are characterized by relatively low dependence on fishing, high use of spear guns and other damaging equipment, intermediate access to boats, rising access to technology and engines, and lack of proper management. Intermediately developed populace do have resources to fish, but they do not have an environmental recognition program built into their government like the highly developed communities. This means that people will continue to fish at high rates without paying attention to their habitats (coral reefs). Education also plays a large roll on the reef-fish biomasses. If people do not learn of the importance of coral reef habitats and the consequences of overfishing, then there will no exigency to protect coral reefs or monitor the fishing rates (Cinner et al, 2009).

It is important to keep in mind that countries may not have traits that exactly match these descriptions of low, intermediate and high development. Many countries will fall in between two of these descriptions. Additionally, there are many other factors that will determine what level of development a certain country falls into. For the purpose of this survey, the characterization of countries will only be determined through the descriptions given above.

From these characteristics, Puerto Rico would be considered an intermediate developed country. The utilization of technology is rising, with a high use of boats with engines, but without sustainable materials seen in highly developed countries. There is not an effective environmental

management plan that will protect the environment including coral reefs. Because of these factors, coral reefs are being damaged and will continue to be damaged unless an effective plan is created to use rafting mooring buoys instead of anchors. This will minimize the physical damage to coral reefs.

2.5.5 Social aspects relating to compliance

This case study interviews fishermen in the New York and New Jersey area. In this survey, advisories are given to fishermen about dangerous amounts of Mercury in fish. The people surveyed are categorized by the amount of fish and crab they consume each month, and their overall knowledge of the advisories given. The survey is designed to determine whether or not the majority of the fishermen know about the advisories and whether or not this affects their consumption rates (Burger, 2004).

An experiment involving commercial fishermen (stakeholders) took place at the Newark Bay Complex in the New York and New Jersey harbor. Many people fish at this location for food like fish and crabs. However, there has been a consumption advisory about dangerous amounts of mercury found in the fish and crab that live in the Newark Bay Complex. The hypothesis was that consumption rates vary with the knowledge about the advisories. Students from Rutgers University tested this hypothesis by interviewing 254 local fishermen. During the interview, the fishermen were asked about their knowledge of the advisories, along with their ethnic background, education level, and work experience (Burger, 2004). Tables 5 and 6 show results of what they knew about advisories. The following table contains results for people who consume crab.

Table 6: The results for advisories involving crabs (Burger, 2004)

Monthly Consumption	Do not eat crab	140-500 g	501-1200 g	Over 1200 g
Sample size	50	41	24	34
% that heard about the advisories	64	27	50	53
% who think the advisory says “do not eat”	34	2	8	9
% that believe the water is polluted	12	0	4	3

The following table still contains information relating to knowledge of advisories. This table pertains to people who consume fish.

Table 7: The results for advisories involving fish (Burger, 2004)

Monthly Consumption	Do not eat fish	140-500 g	501-1200 g	Over 1200 g
Sample size	59	28	30	27
% that heard about the advisories	73	21	41	54
% who think the advisory says “do not eat”	36	10	6	3
% that believe the water is polluted	22	14	20	19

In total, only 45% of the people interviewed knew that the fishing advisories existed, even though both New York and New Jersey strongly advertise these warnings. But for the people who did know about the advisories, they are still continuing to eat fish and crab despite these advisories. This noncompliance is due to a lack of detailed knowledge about the negatives effects of mercury and the extent of how serious the situation is (Burger, 2004).

Overall, it was found that the commercial fishermen ignore the advisories and continue to catch fish and crab and consume them. Perhaps in addition with these advisories, there needs to be information on the effects of Mercury and how it can cause neurological damage when it is consumed. When this information is given, maybe then people will be more concerned about the advisories, and will stop fishing. This hypothesis correlates to the project in Puerto Rico that involves anchor usage and coral reefs. The boaters in Puerto Rico may know the extent of the damage to the coral reefs; however, if they do not know of the coral reefs’ importance, it may be a reason why the boaters continued to drop their anchors instead of using the mooring buoys, as observed by Bouchard et al (2013). It is possible that the buoys were installed without any sort of promotion program to explain why they should be used instead of anchors. This also correlates to one of the recommendations of Bouchard et al (2013), which is to create an education program that is mandatory for all boaters in order for them to receive their permits. The education program would cover the importance of coral reefs and why they should be protected (Bouchard et al, 2013).

2.6 Social marketing campaigns

In order for people to change their established practices, there is a need for a social marketing campaign to educate the targeted audience. These campaigns focus on changing behaviors. They sometimes promote the adoption of a substitute for an undesirable behavior and then work on maintaining the new behavior. For those people who have yet to consider change, the emphasis will be on social education to promote change. For those who are already committed to the new behavior, emphasis will be on continuation of the changed behavior (Peattie et al, 2009). Below are some general means of spreading a social marketing campaign:

- Pamphlets
- Advertisements in the newspapers
- Social Media
- Commercials on the television
- Billboards
- Door-to-door campaign
- Celebrity endorsement

While mediums such as commercials and celebrity endorsement might not be cost-effective or feasible for the budget of DRNA, usage of pamphlets, door-to-door campaigns and advertisements in the newspapers might be more plausible. Techniques like social media can also be initiated by the project. In this section, different social marketing strategies are explored.

2.6.1 Community-based social marketing campaign

In developing countries, it is sometimes believed that there is suspicion toward social change. For coastal management to occur, emphasis can be laid on community-based management, and community empowerment to enable the protection of commonly owned natural resources. More specifically, coastal management programs are sustained when they are owned by the people who are directly affected by their actions (Olsen et al, 2000).

Advertising and raising awareness about an issue does not always lead to a change in behavior. To successfully promote behavioral changes in a population, a community based social marketing plan can be created. This involves selecting a behavior to be promoted, identifying the barriers to this behavior, and finding strategies to overcome these barriers (McKenzie-Mohr, 2000). When individuals in specific communities are given a voice, it will impact the decisions in

initiatives that directly affect them. By inclusion, any new initiative will have a better chance of being accepted and used by the people. This way they will not feel that change is being forced upon them, but will recognize the benefits of positive social change (Olsen et al, 2000).

The first step in building a community-based social marketing campaign is selecting the behavior to be promoted. Larger environmental goals, such as waste reduction, can be accomplished by promoting activities such as recycling, reusing, or reducing consumption (McKenzie-Mohr, 2000). These behaviors are split into two categories: one-time and long-term. There are benefits to each type of behavior, depending on the goal to be achieved. For example, the one-time activity of buying and installing energy-efficient light bulbs would be more useful in curbing energy consumption than creating a program to shut off lights when leaving a room (Hollander, 2011). The behaviors that would help with an issue should be weighed against each other to see which is the most effective for the least investment of resources. Then the barriers to reach this behavior can be identified.

Without knowing the barriers that prevent a behavior from happening, it can be difficult or even impossible to promote this behavior (McKenzie-Mohr, 2000). Identifying barriers can be done through communication with the target population, in the form of focus groups and surveys (Hollander, 2011). This communication will hopefully give a better understanding of why the behavior is not already prevalent, as well as some possible ways to overcome these barriers. Then, a strategic plan can be created by working through each barrier individually using the information gained from community outreach.

This type of social marketing does not rely heavily on advertising or raising awareness. It focuses on social interactions with the target population to understand why a behavior is occurring and what can be done to change it.

2.6.2 De-marketing social campaign

Social marketing campaigns have been successful in changing deeply ingrained behaviors of people, and also in some cases have made certain products detestable. Such campaigns, by which the public is discouraged from using a product or from a practice, are referred to as demarketing social campaigns (Peattie, 2007).

Targeting a large audience through advertising is a challenge for any marketer. In the past, advertising has been used to tackle social problems. In order to highlight the damage caused by a product or by certain behaviors, advertising has been an effective tool (Hassan et al, 2009). This

can be exemplified in the *Truth* campaign carried out in Florida. The main purpose of this campaign was to promote anti-tobacco attitudes among the youth of Florida. The results of this campaign were very encouraging as the number of young people from Florida who were anti-tobacco had increased significantly than those in other states where the campaign did not exist (Sly et al, 2001).

Social marketing makes the use of marketing techniques to focus on a specific audience to abandon a behavior for the benefit of an individual or community as a whole (Peattie and Peattie 2009). What the marketers used to target their audience in the *Truth* campaign was to promote anti-tobacco beliefs was to link the use of tobacco to the risk of breaking ties with one's peers. Being anti-tobacco was marketed as a popular brand to create higher social standings among one's peers. The campaign had endorsements from celebrities, commercials between popular television shows (including the Super Bowl coverage), and the production of a documentary to show how tobacco companies manipulate popular culture to promote their products. The marketers also used the internet, which was gaining popularity among young people at the time, to spread their campaign by engaging with discussions online and by storing information on websites (Peattie, 2007).

In short, the campaign was successful in making the targeted audience (the youth of Florida) change their perspectives on tobacco by making the latter's use socially unacceptable. According to the Florida Youth Tobacco Survey, the number of smokers decreased by 19.4% in middle schools, and by 8.0% in high schools (Peattie & Peattie 2009). The success of the *Truth* campaign can mainly be attributed to their strong marketing strategies that specifically targeted the main stakeholders. Such strategies can be incorporated if advertising is going to be used to change the boaters' established behaviors that pertain to boat-securing practices.

2.7 Past projects

Our project is an extension of a recent project report called *Nautical Community Mooring Buoy Utilization in Puerto Rico*, carried out by another team of WPI students with the DRNA (Bouchard et al, 2013). The previous team made a list of recommendations for the DRNA to pursue in the future, and the team this year is tasked with pursuing some of these recommendations. Thus, in this section a comprehensive summary of the findings of the earlier report is provided. The main purpose of the project was to analyze boating behavior in mooring locations and create a profile of mooring usage by boaters in five specific areas of the La Parguera

and Guánica (Caracoles, Collado, Enrique, and Mata La Gata). These areas are depicted in Figure 22. At these locations, Bouchard et al (2013) assessed the nautical community’s knowledge of proper mooring usage and the importance of benthic communities. Photographic assessment, onsite observations, and survey responses were used in evaluating the effectiveness of the mooring buoy.

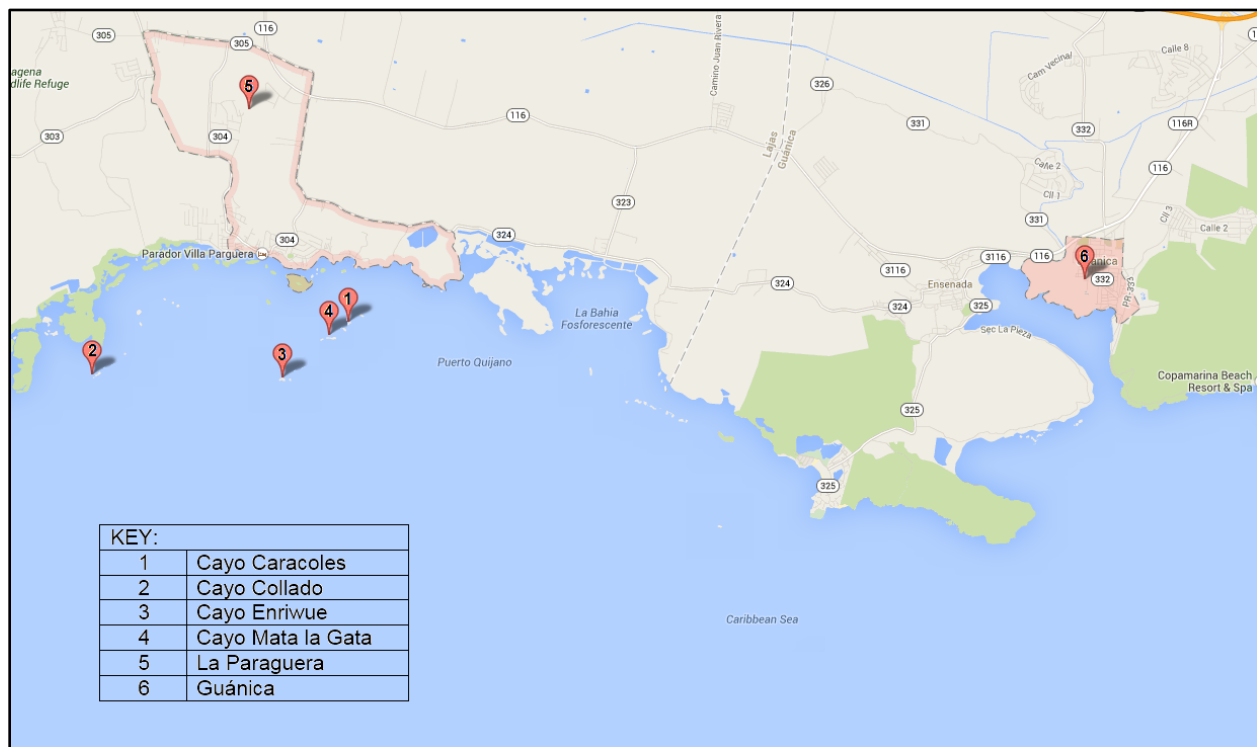

Figure 22: A map of areas in Puerto Rico that were analyzed by Bouchard et al 2013

2.7.1 Results of the most recent project

The past team conducted interviews with multiple staff members of the DRNA and also with two DRNA Maritime Rangers, one patrolman and one higher ranking sergeant. It was found that these experts felt that the nautical community was not fully aware of the amount of damage their boats were causing. So, the team created an educational course to inform the community about the significance of ocean ecosystems and moorings in Puerto Rico. After the interviews they, analyzed aerial photographs, created standardized surveys administered by the team, and observed the nautical community. The results of assessing the photographs and onsite observations were compared to each other, and then compared to specific survey responses to gain further insight into why the moorings have or have not been effective. The photographic

assessment results showed that 57% of the total boats observed were anchored, while only 16% of the boats used mooring. To assess the total number of boats that were using moorings, with or without anchoring, the team combined the onsite results of mooring and anchoring with the onsite results of solely mooring. The photographic and onsite results allowed the team to see that the moorings are not being used effectively in comparison with the observed boater population. As a result, the nautical ecosystems have suffered. The purpose of moorings is to eliminate boating damage to nautical habitats and it was clear that the goal was not met. Another issue that was found was rafting, that often leads to anchoring. So the team created a new design for a rafting mooring, focusing on allowing boaters to participate in rafting behavior without the use of anchors.

2.7.2 Recommendations

The recommendations made by Bouchard et al (2013) form the basis of the current project. Specifically, Bouchard et al (2013) designed a novel mooring buoy, shown below in Figure 23, and recommended testing of the viability and performance capabilities of the system. They also recommended that, if the new system is viable after testing, it should be implemented.

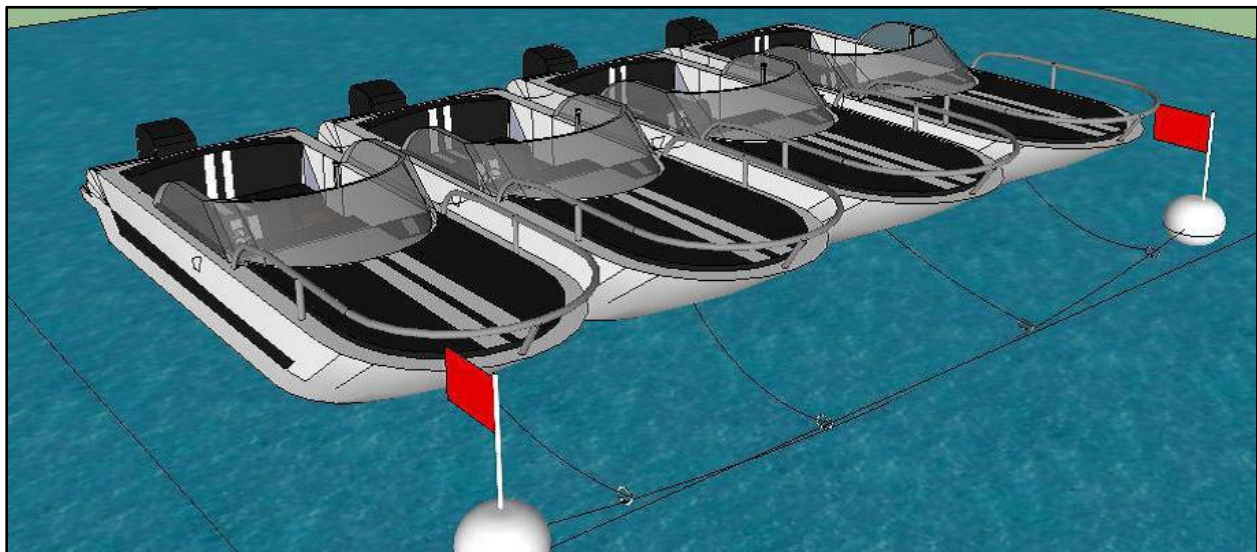

Figure 23: An alternative mooring design (Bouchard et al, 2013)

This will allow a specified number of vessels to engage in rafting behavior, without the necessity to drop anchor in order to remain stationary. The system involves two Manta Ray anchor based moorings, set at a designated distance apart and connected by a hot dipped galvanized steel cable. Hot dipped galvanized steel protects the metal from damage and corrosion

(Lu et al, 2006). Each vessel individually attaches to the cable using rope from a mounting point on its bow. This design allows for four 16 - 30 feet boats to raft safely without any risk of damaging the rafting mooring or the boats themselves (National Oceanic and Atmospheric Administration, 2005).

2.8 Summary

Coral reefs, mangroves and seagrass in the Puerto Rican cays are vital to the health of the ecosystems as a whole. Without them, many other forms of marine life would die. Ocean acidification would also occur which would affect not only Puerto Rico, but the entire ocean. In the Puerto Rican cays, marine life is being damaged by anchors from local and recreational boats. In order to protect these species, something must be done to deter anchors from being used. In the past, moorings were installed to rectify this behavior. However, ecological damage via anchors was still prevalent and in need of addressing. The best solution to this issue was found to install rafting mooring buoys. The rafting mooring buoy will be able to sustain a greater load than a regular mooring buoy, since boats are often tied together. Not only will a 3 dimensional blueprint be created, but also an implementation plan to promote the rafting moorings for the DRNA to use. Since there are many social aspects of our project, it will be important to take in account the boaters, law enforcement, and the DRNA's thoughts and opinions so the best solution for everyone can be created. This plan will include marketing strategies that show how useful the rafting mooring can be and why it should be used as a better alternative to anchors.

3.0 Methodology

This project was intended to aid the Departamento de Recursos Naturales y Ambientales to reduce the damage to marine habitats caused by anchors in the Puerto Rican cays. This involved collecting knowledge from various stakeholders, creating multiple designs of a rafting mooring buoy, and comparing those designs to determine the most feasible design. Once a final design was chosen, a plan was made for the DRNA to implement and promote this system. Project work was completed with the DRNA from October 27, 2014 through December 18, 2014. The following objectives were created to make this project successful:

1. Gather existing knowledge of boat-securing devices and their impact on marine life from major stakeholders: DRNA and boaters
2. Create and analyze multiple 2D designs of rafting mooring buoys building on previous work done by Bouchard et al (2013), and information gained from Objective 1
3. Gather feedback from major stakeholders and make design adjustments as necessary
4. Compare all the designs using an engineering value analysis
5. Create a strategic plan for the DRNA to implement and promote usage of the rafting moorings

3.1 Gathering stakeholder knowledge

Our first step in this project was to assess the knowledge of both groups of major stakeholders. This aided in the creation of the design as information was gathered throughout the project. The knowledge of both the DRNA and the boating community was evaluated, while each stakeholder group provided different information that contributed to the overall design of the rafting mooring buoy. From this information, we identified exactly what needed to be done to help promote and build the system. This information was gathered through a survey that was featured in both English and Spanish (see Appendix A and B).

We went to San Juan Bay Marina on November 12th, to hand out surveys to boaters. We went early in the morning to speak to boaters before they went out on their boats for the day. We also went to the Culebra Marina on November 28th, to hand out surveys to boaters in the late afternoon. Handing out surveys in the late afternoon specifically targeted boaters who were coming back to shore after being out on their boats during the day. At both marinas, surveys were available in both English and Spanish.

On November 28th and 29th, we went out on a boat with DRNA rangers to examine mooring buoys around Culebra Island and to hand out surveys to boaters who were currently out on their boats. Sometimes, we specifically targeted boats that were either using DRNA mooring buoys or rafting with other boats while using anchors to secure their boats. We accomplished this by briefly describing what our motives are and then requesting permission to raft together with the boat. From there, we explained to the boaters what our project is about and if they could take our survey. Once again, surveys were available in both English and Spanish. Boaters could then take our survey and quickly return them back to us.

In addition to handing out surveys in person, there was also an online version of the survey that was created in Qualtrics. This online survey program allowed the surveyors to easily access the results of the survey and analyze the data. The hyperlink to this survey was sent out to the subscribers of *La Regata*, a newspaper for the local boating community (<http://www.laregatapr.com/>). *La Regata* provides information about the different marinas located throughout Puerto Rico, as well as any events and news that relates to the ocean or boating. Therefore most of the readers who took the survey had some sort of connection to boating. In order to distribute the survey to the subscribers, we sent an email out to the chief-editor of the newspaper, Benito Rodríguez. We called him to ask if he would send out our survey to subscribers of *La Regata*, and he gladly said yes. Knowing this, we first prepared an email to Benito that he could forward the subscribers. We then translated the email in Spanish and included the links of the Qualtrics survey in both English and Spanish (see Appendix C for the exact email). We sent out this email on November 7th. We then joined the list of subscriber so we knew exactly when he forwarded the email. Benito sent the email on November 20th and because we received quick responses, we closed the survey on December 8th.

With the results from the survey, we presumed what the boaters know about using mooring buoys. It was important to know if the boaters knew how to use the mooring buoys and if how they used them at all. Below were some of the topics covered in the survey that related to the boaters' knowledge about mooring buoys:

1. The boaters' level of comfort with latching their boat onto the mooring buoy
2. Whether they use the mooring buoys more often than dropping anchor

The survey also asked questions that were related to why the boaters should use mooring buoys instead of anchors. With this information, we concluded what percentage of boaters knew about the purpose of the mooring buoys. If they did not know, then they would need to be informed in some way, and we used this sort of insight in creating the strategic plan (Objective 5, see section 3.5). Specifically, our survey asked questions such as

1. Do you know what mooring buoys are and why they are used?
2. Does boat anchoring put marine life in danger?

The data helped us determine if further education or lessons were needed for the boaters in order for them to start to use the mooring buoys regularly. This education could include instructional classes on how to safely use the mooring buoys or brochures that explain the roles of coral reefs and seagrass. The survey also asked about the most popular boating areas around Puerto Rico, by having the survey respondents list the marinas and cays where they most often boat. Overall, we specifically made this survey to help the design and implementation of the rafting mooring buoy system to be specifically catered to the local boating community in Puerto Rico.

Not only was the boating community surveyed, but representatives of the DRNA were interviewed who have past experience with previous mooring buoy projects, specifically the F27 project. One of the staff members that we interviewed was Carlos Matos, the current leader of the F27 project (see Appendix O for the interview notes) These interviews helped the technical aspects of the rafting mooring design and helped clarify the process that would have to be undertaken in order to install a rafting mooring buoy. We were not able to participate in the actual construction of the rafting mooring buoy in the scope of this project due to a lack of required permits. Overall, the information we obtained from these interviews also aided in the overall design of the rafting mooring buoy system. For example, we asked survey respondents about the average number of boats that they secure together with when engaging in rafting. From this question we were able to design the rafting mooring buoy to accommodate appropriate amounts of boats that would satisfy the boaters and would not cause to the system to fail. Survey answers also helped with the strategic plan for the DRNA.

Obtaining knowledge and expertise from both groups of major stakeholders within the first phase was crucial to the overall project goals. Not only did this process give insight to the

current status of the mooring buoys, but it also generated connections among stakeholders which was essential later on in the project. At the end of the survey, we included text that explained that a rafting mooring buoy design was in the process of being created. Survey respondents had the option to leave their contact information if they would like to see the rafting mooring design once it was finished and give their input and suggestions. They were informed that none of their personal information would be shared with third parties and that names would not be associated with answers. All of the information obtained from the survey and interviews was reviewed. Information that pertained to the strategic plan for the DRNA was saved and used later on in the project to make recommendations. Any information relevant to the design of the rafting mooring buoy contributed to its creation, which is further explained in the next section.

3.2 Creating a design of the rafting mooring

The first step in developing any new system is to create an optimum design that complies with the target users' needs. There are many different computer-aided design software packages that engineers use when creating a design for a product, but the main software that was used in the development of our project was SolidWorks. SolidWorks is a computer-aided design (CAD) operating system that offers complete 3D software tools, allows the user to create, simulate, publish and manage their own data (SolidWorks, 2014). In SolidWorks, initial designs were made as two-dimensional (2D) sketches on three-dimensional (3D) planes and then assembled together. In this case, the different 2D designs of the rafting mooring were created with the constraint of building off of the existing moorings around Puerto Rico. Creating completely new designs was out of the question because of lack of permits and funding.

The 2D sketches consisted of geometrics such as points, lines, circles, etc. An example of a 2D design can be seen in Figure 24. The correct dimensions were then added to the sketches to define the size and location of the elements. All the dimensions for the different components of the rafting mooring were given to us by the DRNA. The components included the chain or cable that connected the buoy(s) together, the buoy(s) itself, and the anchor systems that attached the buoy(s) to the ocean floor. Once the 2D sketches were complete, they were extruded or cut to add or remove material from them. After that, the necessary materials required for each of the separate parts was chosen. The materials with the most favorable properties and lowest overall cost were chosen to complete the design. Once the materials for each part were finalized, the different parts

of the mooring buoy were assembled together to create the final design of the rafting mooring. One example is the anchor systems attached to the rope. This was done with the final rafting mooring design.

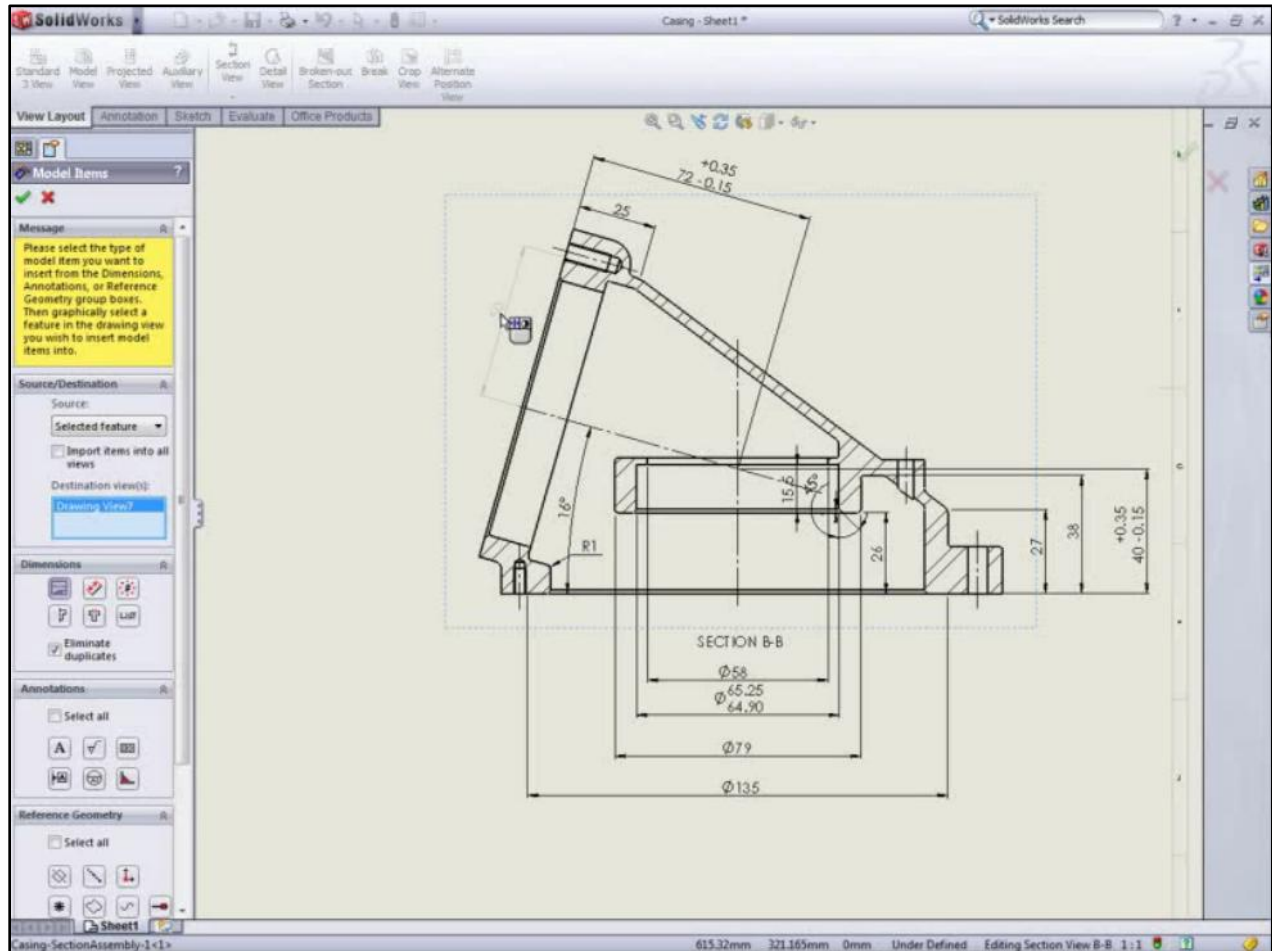

Figure 24: Example of a 2D design in SolidWorks (SolidWorks, 2014).

3.3 Gathering feedback from boaters

With a few prototype designs made, we then gathered feedback from stakeholders in order to assess their responses to the designs. Designs were presented to the two major stakeholder groups, representatives of the DRNA and local boaters, in separate settings, and feedback was gathered through surveys and general concerns or suggestions. Whenever possible, designs were adjusted to reflect these recommendations.

We first presented the rafting mooring designs to local boaters. This was done by creating another survey, where pictures and descriptions of the designs were given out to the boaters, and

feedback was collected by the means of a second survey that had simple ranking questions, followed by a few brief open-ended questions (see Appendix E and F for the survey). The survey included two possible designs for the rafting mooring. Only interactive parts of the rafting mooring (the parts that are used to moor) were presented on the survey. We sent this survey out to the list of the *La Regata* subscribers (see Appendix H for the original email sent to Benito) as well as the list of emails we received from the first survey. When we sent out the surveys to the list of emails we received from the second survey, we made sure to keep the list of emails anonymous so their information was not given to any third parties.

Our survey was created online in Qualtrics in both English and Spanish. We first emailed this survey to the two groups mentioned on December 9th. Because we received such quick responses, we were able to close the survey on December 12th, since we needed to conduct analysis on our results quickly and efficiently.

From our second survey, we wanted to know if the boaters would find it applicable to use either of the rafting mooring designs. Accordingly, we asked boaters to rank (on a 1-5 scale)

- How easy they believed it would be to moor onto the rafting mooring
- How comfortable would they feel rafting on the rafting mooring without using anchors

These questions were asked for each rafting mooring design presented. We also asked respondents to briefly describe

- What could be added or changed to either of the designs
- What additional information they would like

All four of these questions were asked to gain insight about each rafting mooring's ease of use. This information was used for our engineering value analysis (see section 3.4). We then asked questions that pertain to our promotion plan of the rafting mooring. These questions ask

- If the respondent would feel more comfortable using the rafting mooring design if a demonstration was shown on how to correctly use a rafting mooring
- How rafting moorings can be marked in order to make them more distinguishable from a regular, single-boat mooring buoy

Results to these questions helped us make recommendations and suggestions for the DRNA. The ultimate goal of this survey was to see how boaters reacted to the rafting mooring design so that we could create a design that boaters would raft to while they are using it.

3.4 Comparison of designs

We selected a final design by comparing all designs. Using analysis received from excel and written out calculations, (see Appendix R for calculations) we measured quantitative data such as the overall cost and strength of the system. Feedback gathered from the DRNA and boaters was used in a qualitative analysis. Along with aiding in the design process, the comments and critiques given by these stakeholders and the quantitative data acquired from our calculations were used to rank the designs in five different categories. The categories were: cost, strength, ease of use, ease of implementation and maintenance. We then gave each category a ranking from one to three based on how important the category was to finalizing the design. Each category was then split up into different factors; those factors were given scores from zero to three. The ranking of the categories and their factors were used to create a scoring sheet for our value analysis. Table 8 is the scoring sheet used in our value analysis.

Table 8: The scoring sheet for value analysis; all of the ranks for the categories and factors are explained in the text

Category	Rank	Factors	Score
Cost:	1	The estimate amount the system will cost	
		Inexpensive	3
		Slightly expensive	2
		Expensive	1
		Extremely expensive	0
Strength:	3	The amount of yield strength calculated	
		High	3
		Medium	2
		Low	1
		Extremely low	0
Ease-Of-Use:	2	How easy it is for user to use	
		Simple	3
		Fairly easy	2
		Slightly complex	1
		Complex	0
Maintenance:	1	How easy it is to maintain	
		Simple	3
		Fairly easy	2
		Slightly complex	1
		Complex	0
Installation:	1	How easy it is to install	
		Simple	3
		Fairly easy	2
		Slightly complex	1
		Complex	0

When creating the scoring sheet we gave each category a ranking on how important the category was to choosing the final design. How we ranked the importance of each category is explained in each corresponding section. A rank of one represented that the category was of low importance and three represented that the category was of high importance. This can be seen in the second column of Table 8. Each category had different factors that were given scores from zero to three. The factor from each category that was the best case scenario was assigned a score of three and the factor with the worst case scenario was assigned a score of zero. This can be seen in the third column of Table 8. This scoring sheet was used to score each design within the value analysis. Table 9 is a blank value analysis table used to compare and contrast the different rafting mooring designs.

Table 9: Blank design value analysis

Design Value Analysis	Rank:	Ring link Design		Helix Design		Rope Design		Swivel Design	
		Score	Weighted Score	Score	Weighted Score	Score	Weighted Score	Score	Weighted Score
COST	1								
STRENGTH	3								
EASE-OF-USE	2								
MAINTENANCE	1								
INSTALLATION	1								
TOTAL									

Using the scoring sheet we compared the designs by giving each design a weighted score. First, the designs were scored within the individual categories. Then, that number was multiplied that by the rank that each category was assigned, resulting in a final score for that category. Once all of the designs were scored within each category, the scores for each design were added up for a total score. The design with the highest score will be proven to be the best design to implement.

3.4.1 Cost

When we chose our final design, the overall cost of the rafting mooring was one of the categories we considered. If we want to create a rafting mooring that could actually be used around Puerto Rico, then it must be relatively inexpensive compared to the overall price to install a mooring buoy, which is around \$2,400 (C. Matos, personal communication, 2014). Since the mooring buoys are a part of a federally funded project, a lower overall cost could increase the likelihood of the permits being approved so the rafting moorings can be created. The permits are needed for field testing and the installation of the rafting mooring buoy.

On a scale of one to three, we ranked cost with an importance of one. We knew that the overall cost to install a brand new mooring buoy is \$2,400 (C. Matos, personal communication, 2014). However most of this cost goes to the installation of the anchor. Because we are making our designs to be built with the current mooring buoys in place, the anchors and buoys that would be used for the rafting moorings are already installed. The only parts that would need to be replaced are the attachment lines, the throughline, and the down line. All of these parts consist of various ropes. For this reason, the cost of the rafting mooring would be relatively inexpensive compared to the normal cost of installing one mooring buoy. Considering that none of the rafting

moorings would require the installation of additional anchor(s), the rafting mooring designs would all be relatively inexpensive.

With the given costs for rope being \$0.61 per foot, \$9 per small buoy used to help keep the downline floating in the water, and \$1,000 per Helix anchor (C. Matos, Personal Communication, 2014); we calculated the ranges for evaluating cost. Any rafting mooring that is over \$1,000 was assigned a zero. Rafting moorings that ranged from \$667 to \$999 in total cost received a score of one. A score of two was given to any of the rafting moorings that would cost \$334 to \$666. Finally, we scored rafting mooring that cost \$333 or less a cost ranking of three.

3.4.2 Strength

We also use the strength to evaluate all of the designs. The strength of the design would be maximum load the design could support given the most extreme conditions that occur. This included both humidity and wind. On a scale of one to three, we ranked strength with an importance of three. This is because it is very important that the system has a high amount of load and tension it can withstand. A design with a high strength means that the rafting mooring would be able to hold more boats. So choosing a design that would hold the most boats is of high importance when finalizing our design. From our results from the first survey, we inferred the average number of boats the respondents usually rafted with. With this average number of boats, our goal was to include at least this number of boats in our rafting mooring design. To determine the number of boats the rafting mooring could support, we needed to calculate the maximum tension sustained on one of the Manta Ray anchors.

To calculate the forces that our rafting mooring buoy would endure, we simplified our calculations greatly, but also considered the conditions which would result in the largest forces possible on the mooring. Calm conditions in the cays allowed us to neglect water current and only consider wind as a force-creating factor. A wind speed of 40 knots (kts) was used in our calculations, as the DRNA suggests that moorings should not be used when wind exceeds this speed, and therefore this wind speed would result in the largest force the mooring buoy would experience.

First, we summed the forces acting on the boat. Because the vessel is floating, we can assume the buoyancy force is equal to the weight force. The tension in the buoy line must be determined in terms of the drag force. The equation for drag force is shown below, with all variables defined. We assumed the system would remain relatively static, so T_B was calculated

using general statics. The angle between T_B and the horizontal axis was assumed to be 180° to find the maximum tension possible. This angle is actually not possible to achieve, because it would mean the line would lay directly on the surface of the ocean, which is impossible when the line is attached to the bow of the boat. Thus, this assumption results in [explain what this does to your estimates].

Figure 25: A free-body diagram of the forces on a boat

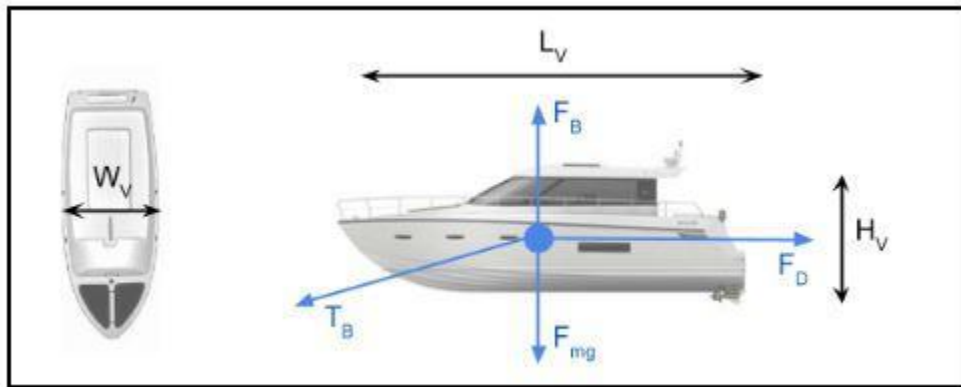

F_B = Buoyancy Force

F_{mg} = Weight Force

F_D = Drag Force

T_B =Tension in buoy line (attachment line)

H_V = Height of vessel

W_V = Width of vessel

L_V = Length of vessel

$$F_D = \frac{1}{2}\rho(v^2)C_D W_B H_B$$

ρ = density of air 0.0717 lb_m/ft³ (at 85F and 70% humidity)

v = velocity of wind (max) = 40 kts 46.03 mph 67.5 ft/s

C_d = Coefficient of drag = 0.04 (for a streamline body)

A = Area exposed to wind = $W_V H_V$

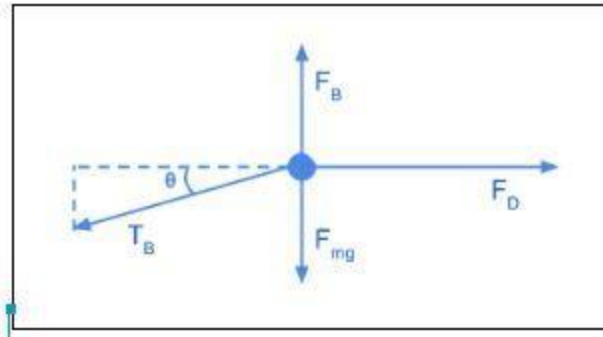

Figure 26: An axis explaining the tension of the downline on the buoy

$$F_B = F_{mg}$$

(because the vessel is floating, we can assume buoyancy is in equilibrium with weight)

$$F_D = T_B \cos(\theta)$$

assume $\theta = 180^\circ$ to get largest tension

$$\cos(180^\circ) = -1$$

$$F_D = - T_B$$

$$F_D = T_B$$

The tension in the mooring line, T_M , was found in terms of the tension in the buoy line, T_B . To find the angle the mooring line makes with the vertical axis, a right triangle was set up as shown below. We calculated the angle to be the inverse cosine of the depth of the water, D , divided by the length of the rope, L_R . The length of a mooring rope can be estimated to be 1.2 times larger than the depth of the water (Trask & Weller, 2001). We wanted to be sure that the angle was large enough so that the rope does not drag on the ocean floor. This can cause dead zones around the anchor (C. Rodríguez, Personal Communication, 2014). Then with this angle, we calculated the force sustained in both the x and y-directions.

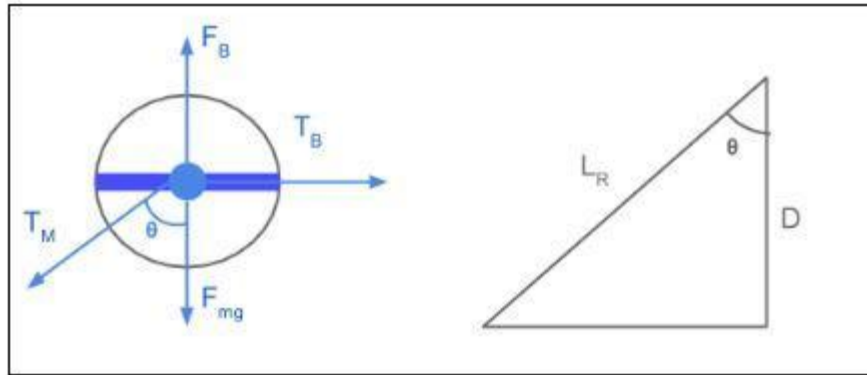

Figure 27: A free-body diagram of the buoy

F_B = Buoyancy Force

F_{mg} = Weight Force

T_B =Tension in buoy line (attachment line)

T_M =Tension in mooring line (down line)

L_R = Length of rope (down line)

D = Depth of water

$$T_M \sin(\theta) = T_B = F_D = 12v^2Cd A$$

$$T_M = v^2CdA/(2\sin(\theta))$$

$$\cos(\theta) = D/L_R$$

$$L_R = 1.2D$$

$$\theta = \cos^{-1} (D/L_R)$$

$$T_M = v^2CdA2\sin(D/LR)$$

Because each Manta Ray anchor was strength tested with a load of 7,500 pounds force (lbf) (NOAA, 2011), we assigned the rating of “extremely low” to a rafting mooring design that could support under 1,875 lbf. A rafting mooring design that could support 1,875 to 3,749 lbf and 3,750 - 5,624 lbf received a ranking of “Low” and “Medium” respectively. Finally, any rafting mooring design that could support a force of above 5,625 lbf received a strength rating of “High”.

3.4.3 Ease-of-use

Ease-of-use was another category that was used to compare our designs. Ease-of-use is how easy it would be for users to use the system. On a scale of one to three, we ranked ease-of-

use with an importance of two. This is because it is important that the system is easy for anyone to use, but it is not critical for choosing the best design to implement. It would be bad if some people did not know how to use our systems but most of our designs had the same attachment as a regular mooring, so this would be highly unlikely.

The factors of this category were: simple, fairly easy, decent, complex. These factors were quantified on a scale from zero to three. If the design is complex, this resulted in a score of zero, while if the design is simple this received a score of three. The ease-of-use of a design was considered complex or simple from the responses of our second survey sent. The questions within the survey that pertained to ease-of-use were:

- How easy do you think it would be to moor onto the rope design
- How easy do you think it would be to moor onto the metal rod design

The answers were on scale from one to five, one being strongly disagree and five being strongly agree. The average response was then found and used to create a range for our value analysis. The ease-of-use of a design was considered complex if the average response was less than 1.25, resulting in a score of zero. A design was considered slightly complex if the average response was within the range of 1.26-2.50, resulting in a score of one. A design was considered fairly easy if the average response was within the range of 2.51-3.75 resulting in a score of two. The ease-of-use of a design was considered simple if the average response was within the range of 3.76-5, resulting in a score of three.

3.4.4 Maintenance

Maintenance was also a category that we considered in our design comparison analysis. This category related to the level of difficulty in maintaining the different system designs. On a scale of one to three, we ranked maintenance with an importance of one. This is because we will not be needing to teach any new maintenance to the DRNA and is not critical for choosing the best design to implement. The DRNA know how maintain these systems. We already know that it takes two hours to perform maintenance on one traditional mooring buoy system (C. Matos, personal communication 2014).

The different factors of this category were: simple, fairly easy, descent, and complex. These factors were judged on a scale from zero to three. A complex maintenance had a score of zero, while a simple maintenance received a score of three. A design was considered to have a

complex maintenance if it contained more than three additional components, above and below water. Underwater lines and components are prone to fatigue overtime or are damaged by wildlife. Therefore, they would need more effort by the DRNA to maintain. Designs were considered to have a decent maintenance if it contained three additional components. Designs were considered to have a fairly easy maintenance if it contained two additional components. On the other hand, designs with one additional component above and under the water were considered to be simpler, and therefore received a score of three.

For four of our designs, the configuration and the materials used above water were the same. For this reason these designs scored the similarly. The last design was different as it had a padded metal rod instead a rope, and therefore scored differently.

3.4.5 Installation

Ease of installation was the final category considered in our design comparison process. On a scale of one to three, ease of installation was given a ranking factor of one with respect to the importance this category to finalizing the design. This is because none of our preliminary designs required new anchor installation, which was the biggest constraint, because it is the most difficult to do. We also gave this factor a low ranking because we knew the DRNA staff was skilled at installing completely new moorings, and have been doing so since the beginning of the F-27 Mooring Buoy project, so making changes to these mooring should not be much trouble for them.

The different factors of this category were: simple, fairly easy, descent, and complex. These factors were quantified on a scale from zero to three. A complex installation resulted in a score of zero, while a simple installation received a score of three. A design was immediately considered to have a complex installation if additional anchors were needed, as the anchors is the most laborious part of a mooring buoy installation.

Designs were given a score of one if they did not need any anchor installation, but did require more than three additional components to be added to current moorings under the surface of the water. Underwater installations must be completed by experienced divers, who have to create a step-by-step plan of what they need to do once they are submerged, to avoid wasting time and energy trying to communicate underwater (Aileen Velazco, personal communication 2014).

Adding more than three components under the water will take a lot of prior planning and puts divers in more risk the longer they but are underwater.

A score of two was given to designs with less than three new underwater components to be installed, but more complex surface installation was required. If the design needed more than two buoys, or replacement with different buoys, it was considered a fairly easy installation.

Designs with no more than one underwater component and minor surface changes were given the highest score of three. We deemed these criteria to be suitable judgment for a ‘simple’ installation because it requires minimum effort from the DRNA, while still creating a rafting mooring buoy out of current moorings in place.

3.5 Making a strategic plan

The strategic plan for the DRNA consisted of two parts: an implementation plan and a promotion plan. The implementation plan outlined the steps to physically put the systems in place around the cays, as well as what must be done to properly maintain the structures already in place (existing mooring buoys with Manta Ray anchors). Information gathered from both the surveys and the questionnaire aided the project in formulating suggestions for where the systems could be placed, and in what quantity. The second part of the strategic plan focused on how to promote use of the systems among boaters, once they were in place.

3.5.1 Implementation and maintenance plan

Once we chose a final design, we looked for places where it could be installed around Puerto Rico. Our initial survey enabled us to obtain names of the places that were popular locations for people to boat. Those areas were Las Pelás (Culebra), Playa Tortuga (Culebrita), Iacos, Piñeros, Mosquito Pier (Vieques), Dakiti (Culebra), Isabel Segunda (Vieques). These locations already have mooring buoys in place. We searched the depths of the ocean in popular locations and took their averages in each location by using the DRNA *Google Earth* database. We also calculated the distances between parallel mooring buoys by the ruler tool on the *Google Earth* software. We were then able to calculate exactly how much rope and other materials were needed for each site. Figure 28 shows the existing mooring buoys installed by the DRNA around the Puerto Rican cays.

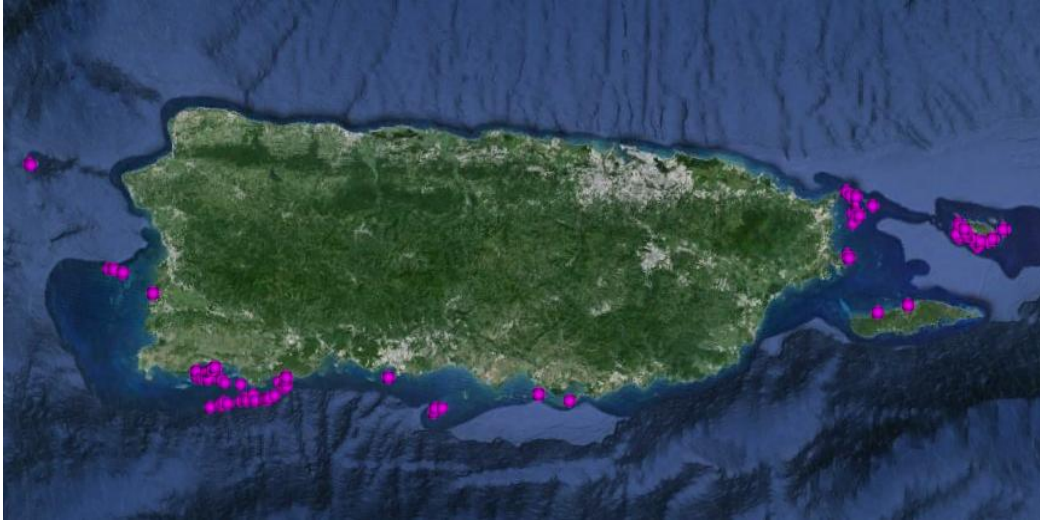

Figure 28: A map of Puerto Rico with existing mooring buoys (in pink); not all buoys can be seen individually because the points overlap in high-density regions.

Through our survey data pertaining to popular boating areas (see Question 1 on survey 1, Appendix D) and data provided by the DRNA pinpointing the locations of the existing mooring buoys, we were able to determine areas that needed the rafting mooring buoy in order of priority. Figure 29 shows the locations of existing mooring buoys in Culebrita (Playa Tortuga).



Figure 29: A map of Culebrita with existing moorings shown in pink

We selected a final design through the iterative process. The new rafting mooring buoys are now to be built upon the existing moorings. We evaluated options for moorings that included the rope design and the metal rod design. Our research on mooring buoys and Informal interviews with DRNA staff gave valuable information about estimated time and costs associated with installing a traditional system. Using this information, we were able to infer costs and time required to build our designs of the rafting moorings which were reported in the results section.

To create a maintenance plan, we learned about the DRNA's current maintenance methods through our conversations with the DRNA personnel. We also looked at a maintenance plan published by the National Oceanic and Atmospheric Administration (NOAA), and a plan that US Navy uses to inspect their mooring fields. By looking at these plans, and using our background knowledge about buoys we came up with a maintenance schedule for the new rafting mooring buoys for the DRNA.

3.5.2. Promotion plan

To create a promotion plan, we first looked at the previous outreach material the DRNA had produced over the years to encourage boaters to use moorings. This included brochures, DVDs, public service advertisements, and posters. Figure 32 shows parts of an educational pamphlet that contained information about the rules of usage of the mooring buoys, the proper way to use a mooring system, and laws against anchoring. The DRNA had distributed this pamphlet to boaters in various marinas around Puerto Rico. Figure 31 shows the front page of an educational brochure distributed among the marinas. Although we do not know about the effectiveness of this brochure, we observed that many people continue to violate the law pertaining to anchorage and many do not follow the properly use mooring buoys as well. Figure 30 shows a picture we took of boater in Culebra who is using the mooring buoy while dropping anchor as well. This is a clear violation of the law.



Figure 30: A boat attached to a mooring buoy and anchored at the same time

The next figure depicts the cover of the educational brochure, created by the DRNA.

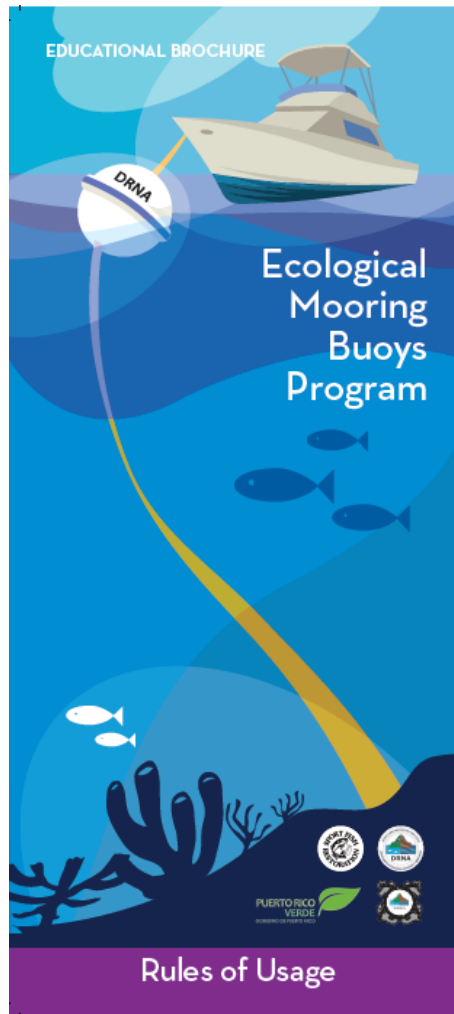

Figure 31: The front page of an educational brochure distributed among the marinas (C. Matos, Personal Communication, 2014)

The next figure shows the inside of the educational brochure distributed by the DRNA.



- 1** Make sure there are no divers or swimmers in the area.
- 2** Navigate slowly, toward the buoy, against the wind or current.
- 3** Have ready a boat hook or gaff and a bow line to tie to the surface buoy.
- 4** Inspect the mooring buoy, making sure that it is in good condition.
- 5** Always run the line (10 - 20 feet long) from your boat through the loop of the floating pick-up line.

Rules of Usage:

- Mooring buoys are for public use, so the first boat to arrive has the right to use it. No one can privatize a buoy and mooring site for their exclusive use.
- The maximum size of the boat to use a mooring buoy is 60 feet long. Never tie the floating pick-up line to the boat cleat. Larger vessels should release more line, to produce a horizontal force on the buoy. Do not tie the line to the surface buoy directly to the boat cleat. This will prevent breakage due to the friction.
- Sailboats cannot be tied to mooring buoys while maintaining the sails hoisted.
- The use of mooring buoys is prohibited when the winds exceed 40mph or to shelter from bad weather (storms or hurricanes).

Legal Framework:

Act No. 147, (1999) "Law for the Protection, Conservation and Management of Coral Reefs in Puerto Rico" establishes administrative fines for the following actions:

- Anchor, fix, or in any other way install or stop a vessel outside the mooring buoys in areas that have been identified as anchor buoys.
- Remove or damage the mooring buoys and marker buoys established by the Secretary to identify coral reef areas.

Administrative fines shall not exceed ten thousand dollars (\$10,000.00) per violation or be less than five hundred dollars (\$500.00). The Secretary may impose, in addition to the administrative fine, payment of a reasonable sum for costs incurred in repairing or replacing damaged buoys.

Figure 32: An educational pamphlet that was distributed at various marinas by the DRNA (C. Matos, Personal Communication, 2014)

In order to promote the rafting mooring buoy to boaters, it is important for the organization to effectively change the boaters' behavior towards anchoring by engaging them in the overall process. During the course of this project, we mainly employed methods that allowed us to engage with the Puerto Rican boaters. This included in-person surveys that we handed out, as well as online surveys which were emailed to a local boating newspaper's subscribers' list. Based on the results from these surveys, relevant information about boaters was obtained. This included data about their age, occupation, and experience in boating. We analyzed the data for correlations between demographic factors, such as age and gender, and anchor usage, and also the best way to reach that target audience. These results were helpful in suggesting recommendations for the DRNA on how to target different demographics. We also analyzed the responses to the second survey and gained insights on what the boaters' general apprehensions were about the new rafting buoys as well as the current buoys installed. This knowledge was also incorporated in our promotion plan.

We also created a *Facebook* page, which was shared with other popular forums associated with the Puerto Rican nautical community through the *Boating Puerto Rico* Facebook page. However, the number of people who "liked" the page was not limited to just boaters in Puerto Rico. This is because some of our friends from back home had also liked the page. According to a Pew survey in 2012, internet users under 50 years are more likely to use a social media platform, while 83% of people from ages 19-29 are likely to use a social networking website (Duggan & Brenner, 2013). Pew Research Center yearly surveys about how people communicate with each other. Pew Research Center achieves these results through online surveys, and by conducting phone interviews in both Spanish and English in United States and its territories.

4.0 Results and recommendations

In this chapter, we present and discuss the results received for each objective. From our results, we give recommendations to the DRNA for the strategic plan.

4.1 Gathering stakeholder knowledge

In total, we received surveys from 97 boaters. We received 22 survey responses from the San Juan Bay Marina, Culebra Marina, and from boaters around Culebra Island. From the online surveys, we received 74 responses from the *La Regata* email list of subscribers, which has a total of 6,422 subscribers, and 1 response from the WPI Marine Team Facebook page. Because the

sample size of the Facebook surveys was only one, a proper analysis was not possible, so this response was not included in our results. We used Qualtrics software to organize our data and keep responses separate for each of the survey distribution methods. We pooled together results for every question except for questions 1 and 17. This is because these questions may be bias based on location and survey method. Although we researched what specific areas need rafting mooring buoys or regular mooring buoys in general, a future project group may need to go observe boating behaviors again. We were only able to observe the areas around Culebra, and were not able to see the boating behaviors of the north, west and south coasts of Puerto Rico. Consequently, in the areas around Culebra that we observed, the popular areas to raft may have changed over time. **We recommend that a future project team should go out to Culebra again and also explore all of the other coasts around Puerto Rico to see where rafting mooring buoys are needed.**

All of the raw data for the first survey can be found in Appendix D. The first question from this survey was used to determine the most popular locations for boaters. A list of places collected from each survey method (online and in-person) was compiled to determine the top ten most popular places for boating. Some locations were combined, such as Culebra and Culebrita, because Culebrita is a part of Culebra. Some locations, such as the US Virgin islands and British Virgin Islands, were omitted because they are located outside of Puerto Rico, and lack relevance to our analysis. Figure 33 contains the results for Question 1. For in-person surveys, n=21 and for the online surveys, n=54. A map of the popular locations is seen in Figure 34. All of these locations currently have mooring buoys except Puerto del Rey. The two survey pools were kept separate for this question. This is due to the fact that in-person surveys were filled out at certain locations, which were often listed by these boaters as a most visited location. This created bias in the question. Online surveys, however, could be filled out from anywhere, and showed more variation in locations reported.

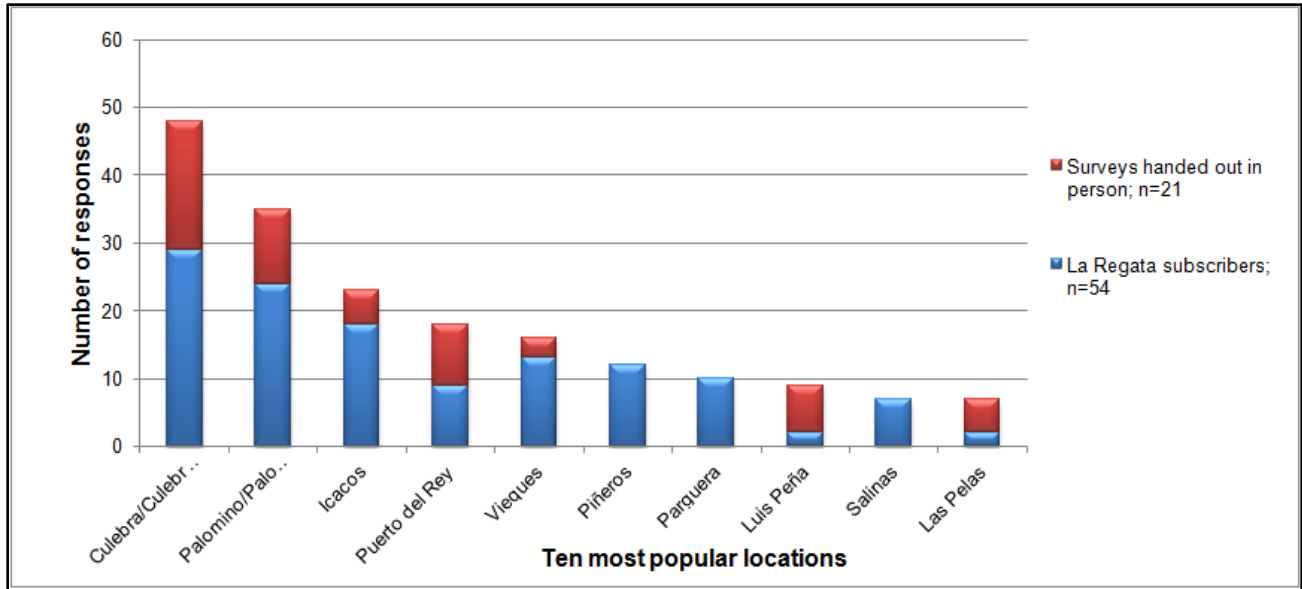

Figure 33: A graph showing responses to “List marinas and cays where you most often boat” from each of the survey groups in survey 1; n=21 for in-person surveys and n=54 Respondents had the options to give multiple answers.

The next figure shows the most visited locations on the east and south coasts of Puerto Rico, based on our results from Question 1.

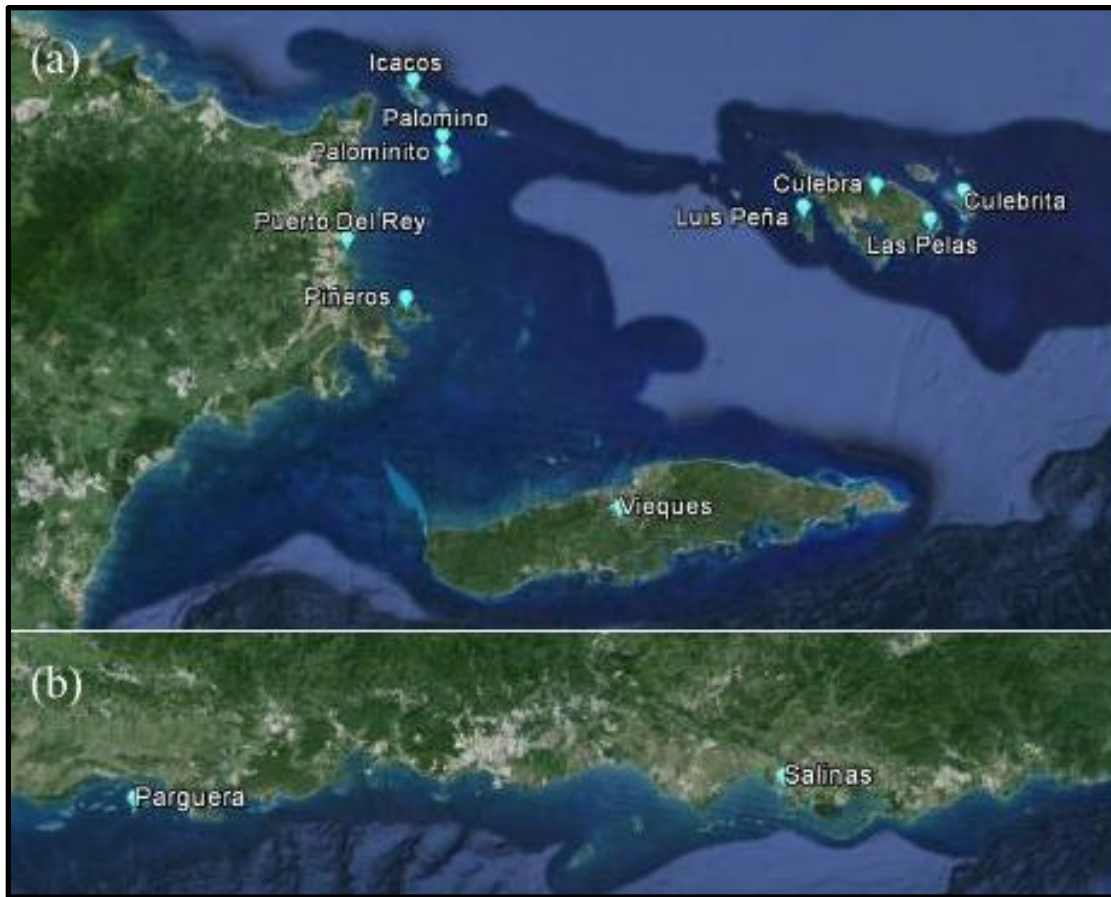

Figure 34: A map showing the most visited places on the (a) east and (b) south coast of Puerto Rico

To determine if boaters who engage in rafting have similar boat sizes, we filtered the responses of Question 6 (n=65): “What is the length of your boat?” to show only those who reported that they raft. Results of this comparison can be seen in Figure 35.

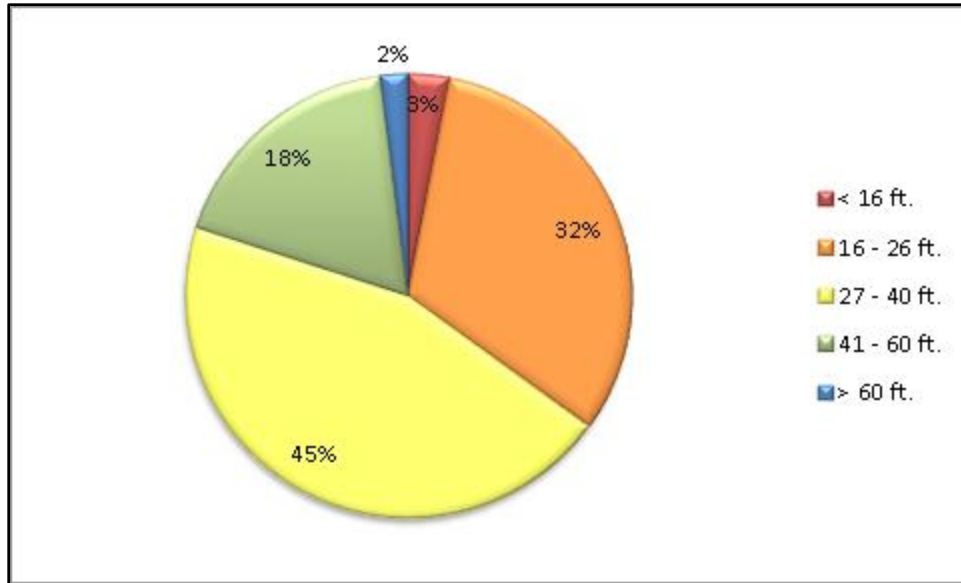

Figure 35: Percentages of people with different boat sizes that replied “yes” to “When boating, do you ever raft onto other boats?”, n=65

From this data, we found that a large majority of boaters who raft (80%) own a boat of 40 feet in length or below. This was significant to our rafting mooring design because it allowed us to focus on boats with lengths of 40 feet and below in length, as this would cater to the largest population of boaters. The dimensions of a 40 foot boat were used later on for strength calculations of our rafting mooring designs.

In order to understand if there is any correlation between age and rafting behavior, we compared the two. The number of people who responded for both age and the statement “ I use mooring buoys and tie together (raft) with other boats” was 91. For the analysis of this statement with age we omitted the results for the age groups “under 18” and “18 to 26”, as we only had 2 responses for both the categories, which were negligible. By comparing this statement, we found out that boaters above 35 years of age are more likely to raft while using mooring buoys. 30 boaters or 33.7% of our total sample size (89) represented this group. We saw that this was also the age group which was not likely to engage in rafting while using the mooring buoy which is 36 boaters or 40.4% of the data. The reason for this surprising result could be due to the fact that people above 35 years of age had a frequency of 79 or 88.8% of the total sample size for this question. By not finding any link between age and rafting, we can assume that rafting behavior is common among all age groups. This finding was important in the promotion component of our strategic plan, which was created for boaters of all ages. The data that compares age group with using mooring buoys and rafting with other boats is graphed in Figure 36.

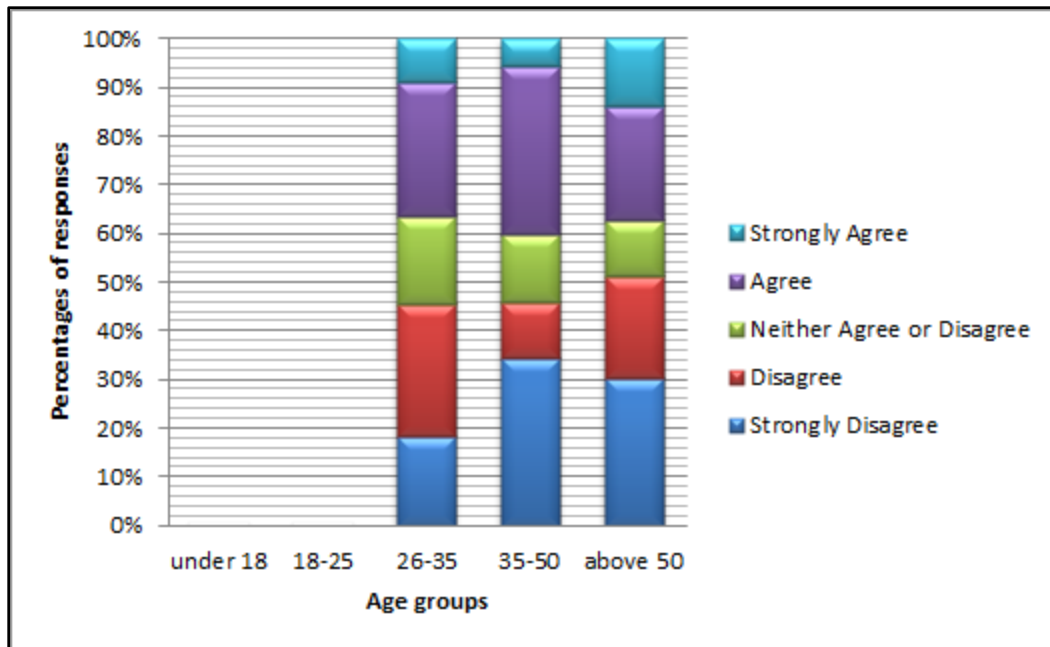

Figure 36: The column bar graph that shows the results of “I use mooring buoys and tie together (raft) with other boats” compared with age group, n = 89

We also tried to see if there was a correlation between people who drop anchors while they used mooring buoys and age. The number of people who responded to the statement “When I use moorings, I also drop anchors” and age was 92. For this question, we also had to omit 2 results which were under the age groups “under 18” and “18 to 26”, as they were negligible. Through these results, we saw that boaters above 35 years of age are more likely to use moorings and not drop anchor. This is representative of 56 boaters or 60.9% of our total sample size (90). The same age group (35 years of age and above) has the lowest number of boaters who drop anchors while they use moorings, 14 or 15.2% of our total sample size. The results show that more than 60% of boaters surveyed do not agree with dropping anchors while using the mooring buoys. Even though our sample size is small and could have been skewed due to the fact that we were face-to-face with boaters as we conducted the in-person surveys, we still established that more than half of the people answered that they do not engage in this behavior. This finding confirmed that there was no link between age and people who drop anchors while using mooring buoys. This also helped us understand that even though 60% of respondents do not engage in this behavior, but those who do drop anchor while using mooring buoys were not bound by any particular age group. Through these results, we came to the conclusion that our strategic plan for the DRNA should not focus on any particular age group. Additionally, we found that almost 40%

of respondents anchor while using mooring buoys, this data was helpful in suggesting recommendations to the DRNA. The data is graphed in Figure 37 clearly illustrates the responses.

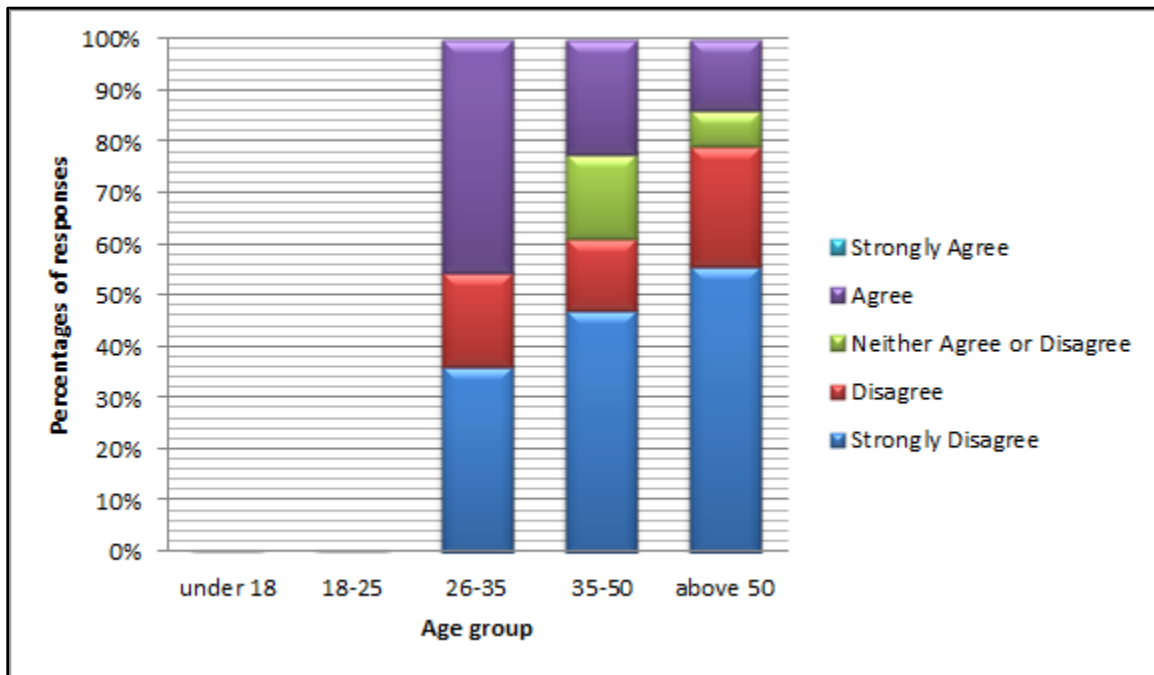

Figure 37: Results of the age groups of people with the answers they gave on “When I use the mooring buoys I also drop anchors”, n = 90

With our results from this survey regarding marine ecosystems, we made various conclusions. The first conclusion that we made was that the boaters’ knowledge of benthic communities is not the reason why boaters are dropping their anchors. Even though many of the survey respondents did not know about the specific functions of coral reefs and the resources they provide, almost all of the survey respondents believed that coral reefs are important in marine ecosystems. 92 out of 93 of the respondents or 98.9% of the sample survey said that coral reefs are very important.

Survey respondents were also able to recognize coral reefs and seagrass on the ocean floor, as 97% of respondents (n=91) said that they can identify these marine ecosystems. This statement is substantiated with the results to the question about the commonality of marine ecosystems. 96% of respondents (n=93) believed that coral reefs are somewhat or very common. Results to these two questions prove that boaters can distinguish coral reefs amongst other marine life. Results from the raw data also proved that boaters know that local population of coral reefs is decreasing, for 92% of respondents (n=89) thought that coral reefs are nearly extinct, or are at a medium or high risk of becoming extinct in Puerto Rico.

Because most of the respondents know about the importance of coral reefs and their current declination in population, then there should already be urgency amongst boaters to use anchors to protect coral reefs. This idea is also supported as 89% of respondents (n=92) said that anchors put marine life in some sort of danger, whether that be a little or great danger. This means that boaters do know about the damage that can occur when they drop their anchors. Because 95% of respondents (n=93) said they know what mooring buoys are and how they are used, this means that boaters do know that mooring buoys are there to specifically prevent the use of anchors around Puerto Rico.

It is evident that boaters know about benthic communities and how these communities are affected by boat-securing devices. Most boaters know that coral reefs and seagrass are very important for the ocean ecosystem, and boaters know that anchors negatively impact these marine ecosystems. Boaters also know that the DRNA installed mooring buoys to be used in place of anchors to preserve sensitive marine ecosystems such as coral reefs and seagrass. This means that there is some other reason why boaters are still continuing to drop their anchors. Even though these results do not exactly tell us why boaters are dropping anchors regardless of the fact that boaters know of the risks, we do know that we do not need to recommend additional educational courses that relay this information. This would waste both the boaters' and the DRNA's time and effort. However, we do recommend that the DRNA should start focusing on enforcing policies.

Law 147 of the Puerto Rican commonwealth defines anchoring as illegal and makes it punishable by a fine ranging from \$500 to \$10,000 (Puerto Rico House of Representatives, 1999). However, anchoring still occurs and almost no one gets fined for this offense (Bouchard et al, 2013). Keeping the Puerto Rican values in mind, which focus on conciliation rather than punitive action against offenders (C. Matos, Personal Communication, 2014), **we recommend punishments and fines for boaters who violate the law.** Table 10 shows how the DRNA could enforce the law to protect the marine ecosystem.

Table 10: How anchoring violations could be punished by the DRNA

Anchoring policy violation	Punishment for the offender
First offense	No fine; just a citation.
Second offense	No fine; not allowed to boat that day
Third offense	\$500 fine; not allowed to boat for that day
Fourth offense	\$1500 fine; boating license suspended for a week
Fifth offense	\$5000 fine; boating license suspended for a month
Sixth offense	\$8000 fine; boating license suspended for 6 months
Seventh offense	\$10000 fine; boating license suspended for a year

As we can see from the table above, boaters who continue to use anchors are given two warnings before an actual fine is handed out to them. This gives boaters who violate this law a chance to change their behaviors. Punishments for the offense gradually become stricter depending on the number of violations a boater commits. Punitive action also would serve as an example for those boaters who continue to anchor but do not get caught. **If policies are strictly enforced, they may help in deterring people from dropping anchor in the long run.**

Question 16 asked “How many mooring buoys are there around the cays?”. It was alarming that 31 out of 81 or 38.3% of the sample size responded with “I don’t know”. What was more striking was the fact that only 4 out of 81 total respondents knew the correct answer that there are over 300+ buoys around the cays in Puerto Rico. A graphical representation of the data can be seen in Appendix D. These results were alarming for us, as less than 5% of the survey respondents knew the correct answer. Based on this information, we can also assume that their knowledge of where these buoys are located is also limited. **Therefore, we recommend that the DRNA distribute informational posters and brochures with maps of Puerto Rico and the surrounding cays showing the locations of existing buoys.** A version of this map should also be included online on the DRNA website so it can be easily accessible to the general public. Later on, locations of the new rafting mooring buoys can also be added to this map. A key can be included to distinguish between single mooring buoys and rafting mooring buoys. Creating this will not be difficult as the DRNA already has a database of the mooring buoys’ GPS locations on

Google Earth. By making a map of the mooring buoys, the chance of boaters using buoys in general will increase as more people will know about their exact locations.

We wanted to know if respondents who felt comfortable using mooring buoys actually used them frequently and correctly. Figure 38 contains data for question 17 (see Appendix D) that represents only the respondents that said “agree” or “strongly agree” to the statement “I am comfortable with latching my boat onto the mooring buoy.” For the ‘average’, 1 would correlate with “Strongly Disagree” and 5 would correlate with “Strongly Agree”. For the in-person surveys, n=16 and for the *La Regata* subscribers, n=52.

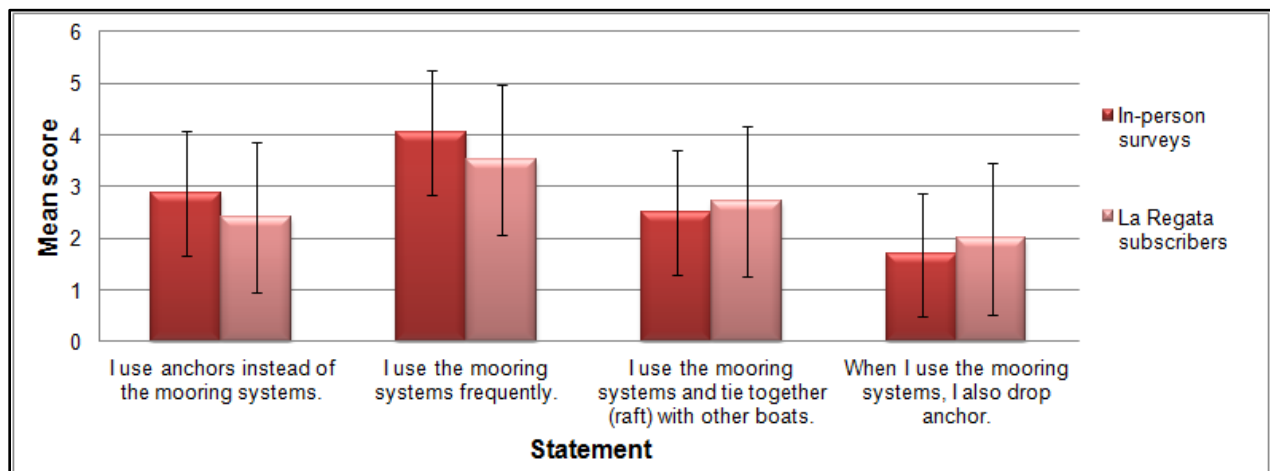

Figure 38: Results to question 17 from respondents who said “Agree or “Strongly Agree” to the statement “I am comfort with latching my boat onto the mooring buoy.” N=16 for the in-person surveys with a standard error of 1.10 and for the *La Regata* subscribers, n=52

In-person surveys:

For the statement “I use anchors instead of the mooring buoys.”, the average was 2.88 with a standard deviation of 1.09 and a variance of 1.18. The average for the statement “I use the mooring buoys frequently.” was 4.06 with a standard deviation of 1.12 and a variance of 1.26. The results from these two questions illustrated that boaters who trust the mooring buoys will use them frequently, however, they may still use anchors on occasion. The next two statements analyzed relate to correctly using mooring buoys. The average score for “I use the mooring buoys and tie together (raft) with other boats.” was 2.5 with a relatively high variance of 2.27 and standard deviation of 1.51. The average score for “When I use the mooring buoys, I also drop anchor.” was 1.69 with a variance of 1.16 and a standard deviation of 1.16. The results from these

two statements affirmed that boaters who feel comfortable using the mooring buoys do not drop anchor. However, we could not conclude that boaters who feel comfortable with mooring buoys abide by all of the rules associated with mooring buoy utilization. This was due to high variance in the statement that asked about rafting with other boats while using mooring buoys.

Online surveys:

The statement “I use anchors instead of the mooring buoys.” had an average score of 2.41, with a standard deviation of 1.11 and a variance of 1.25. Additionally, the statement “I use the mooring buoys frequently” received an average score of 3.53 with a standard deviation of 1.30 and a variance of 1.71. These results were parallel with the idea that boaters who are comfortable using the mooring buoys do use them frequently, although the correlation is not as strong as the results from the in-person surveys. After the statements about frequency of use of mooring buoys, we then evaluated the statements that referred to proper utilization of mooring buoys. The average score to the statement “I use the mooring buoys and tie together (raft) with other boats.” was 2.71 with a variance of 1.92 and standard deviation of 1.38. The statement “When I use the mooring buoys, I also drop anchor.” received an average score of 2.00 with a variance of 1.95 and a standard deviation of 1.30. These results signify that most boaters do not drop anchor when using mooring buoys, although rafting may occur when they are attached to a mooring buoy.

Results from both groups of data corroborated the idea that boaters who are comfortable attaching to a mooring buoy do in fact use them frequently. Anchors, however, may be used on occasion. These boaters, for the most part, use mooring buoys correctly. Most of these boaters do not drop their anchors while attached to a mooring buoy, but may raft with other boats from time to time. It must be known that the total sample from this analysis is 68. Because of this relatively small sample size, we cannot conclude that this information is definite.

Based on these findings, we inferred that boaters who feel comfortable with mooring buoys are more apt to use them. For our rafting mooring design, this means that in order to promote our design and persuade boaters to use the rafting mooring, they must feel comfortable using the system.

To better understand why boaters engage in rafting, we filtered the data from Question 2 to show only the responses of those who reported that they raft in Question 7. Figure 39 shows the percentage of boaters who reported they raft and selected socializing as one of their boating activities. The two survey groups produced similar results, within 3% of each other, so we

analyzed the weighted average of the collective data. A weighted average accounts for the size of each group by multiplying the results by the number of respondents in the group before taking the average of these results.

The collective results from both survey groups showed that 82% of people who raft are also socializing (n=92). This is a strong correlation, and confirmed our beliefs that a major proponent of rafting is social interaction with other boaters. Here is a pie chart of these results.

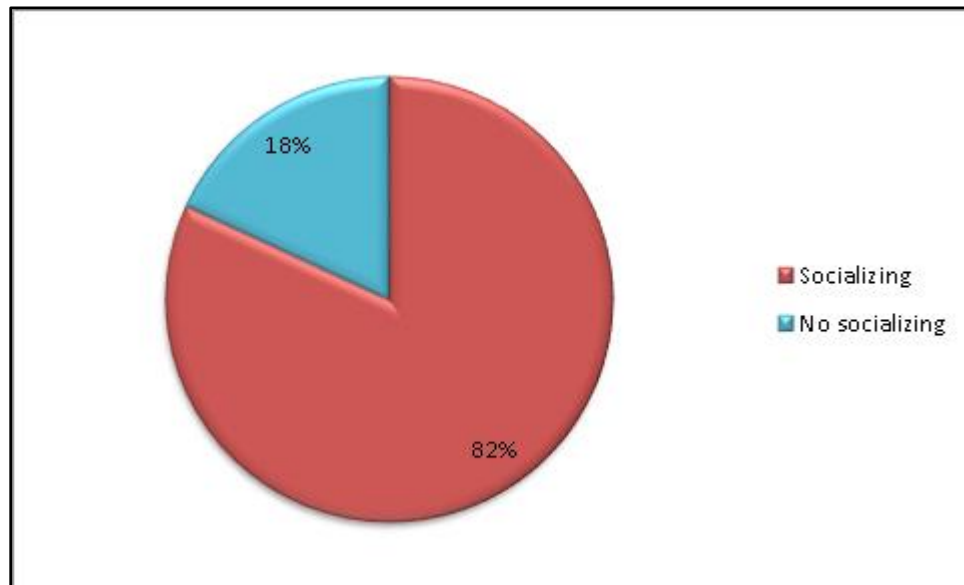

Figure 39: From among the boaters who reported that they engage in rafting, percentage of respondents that selected 'Socializing' as one of the reasons they boat, n=93

We further explored behaviors associated with rafting in Question 17. The last four statements were filtered to show responses only by those who reported they raft, to see if boaters use the mooring buoys in conjunction with rafting. The four statements in this question were:

1. I use anchors instead of the mooring buoys.
2. I use the mooring buoys frequently
3. I use the mooring buoys and tie together (raft) with other boats
4. When I use the mooring buoys, I also drop anchor.

The two survey groups were kept separate for this analysis, because the in-person survey respondents may have felt coerced to answer a certain way, due to our presence, and the presence of a DRNA ranger. Because the sample size was only 22 for the in-person surveys, these results were not relied on as heavily in the analysis as the online survey, which had 68 respondents.

Statement 3, “I use anchors instead of mooring systems.”, responses did not have a significant difference between those who raft and those who do not. The averages for both survey groups fell right around 2.6, within 5%.

Although most of the averages fell in the disagreement range (below 3), the higher values can still indicate how often an action occurs. For example, for both survey groups there is a higher average. For Statement 4, “I use mooring systems frequently.” for those who raft than for those who don’t. From this result, we concluded that those who raft tend to use the mooring buoys more frequently than those who do not raft.

Results for Statement 5, “I use mooring buoys and raft with other boats.”, showed the most drastic difference between responses of rafters and non-rafters. This makes sense because boaters that do not raft are not going to raft even if they are mooring. These results also show that rafting does occur even when one of the boats is connected to a mooring buoy.

For Statement 6, “When I use the mooring systems, I also drop anchor.”, results from the online survey showed that those who raft are more likely to drop anchor while attached to a mooring. This could be because boaters know the moorings are only meant for one boat, and anchor for extra stability, but additional surveying would be required to ascertain this. Figure 40 shows all of this data, first with just the results from the *La Regata* subscribers.

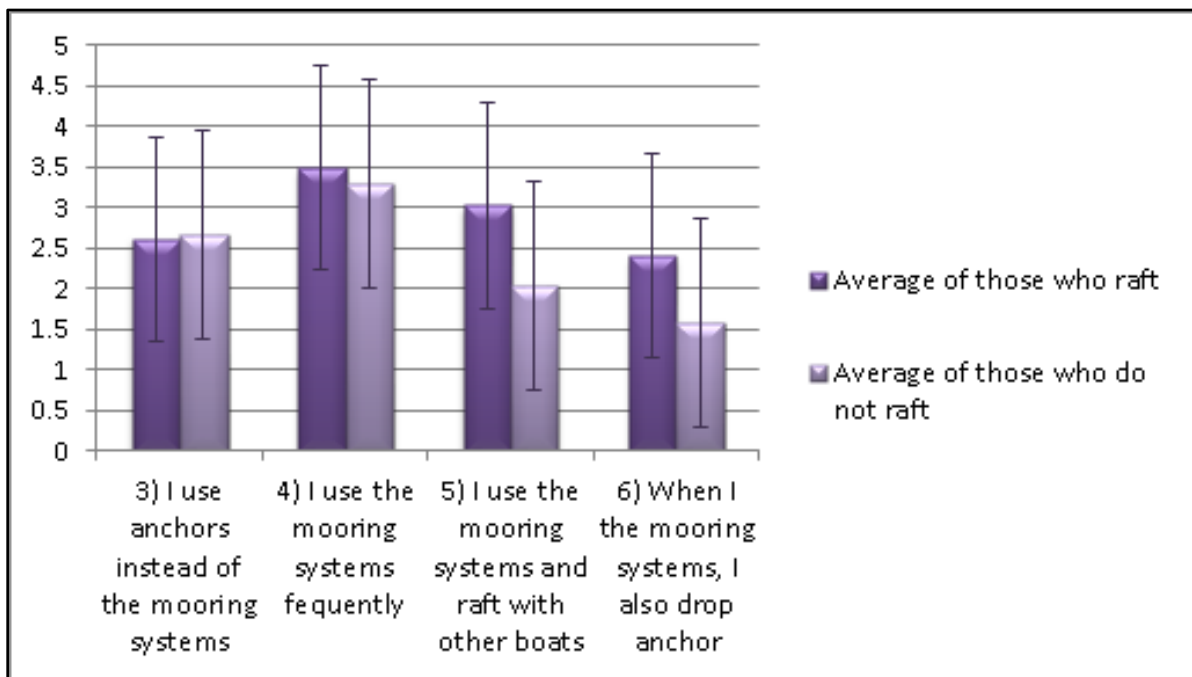

Figure 40: The average online survey responses to Question 17 statements in comparison to responses to “When boating, do you ever raft (tie two or more boats together) onto other boats?”, n=68

The next figure (Figure 41) shows the results for just the in-person surveys.

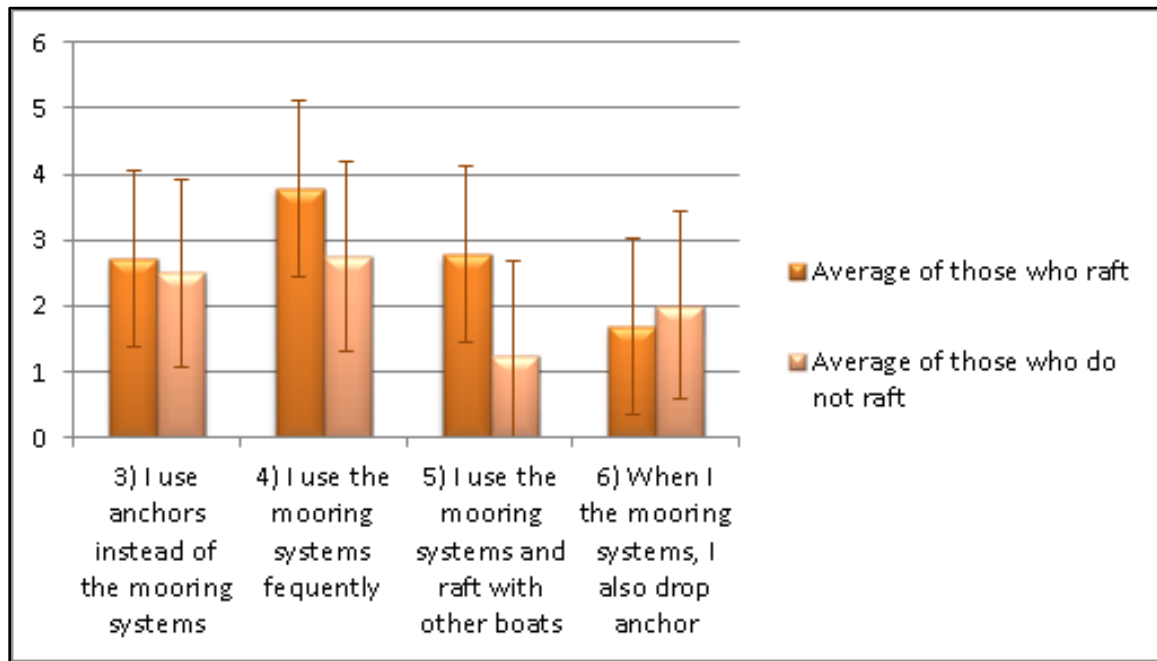

Figure 41: The average in-person survey responses to Question 17 statements in comparison to responses to “When boating, do you ever raft (tie two or more boats together) onto other boats?”, n=22

4.2 Rafting mooring design

The next step in completing this project was creating multiple rafting mooring designs. We first created preliminary drawings of possible designs, to show configurations of components, and worked through their faults to improve them. Then, each part of the designs was created separately in SolidWorks where the parts were assembled together to make the final design.

4.2.1 Preliminary drawings

We created preliminary drawings for the rafting mooring design building off the original design created by Bouchard et al (2013). All of these designs are meant to hold a maximum of six, 40 foot boats. This was determined from the first survey to be the number that would cater to the largest population. The first drawing, seen in Figure 42, depicts the original design, which was simply a system in which a cable connects two mooring buoys. Attachment lines would be connected to this cable for boats to connect to as they would a regular mooring. Boaters would then be able to securely raft with neighboring boats. The following figures, Figures 42 through 46, show different design options for the rafting mooring design.

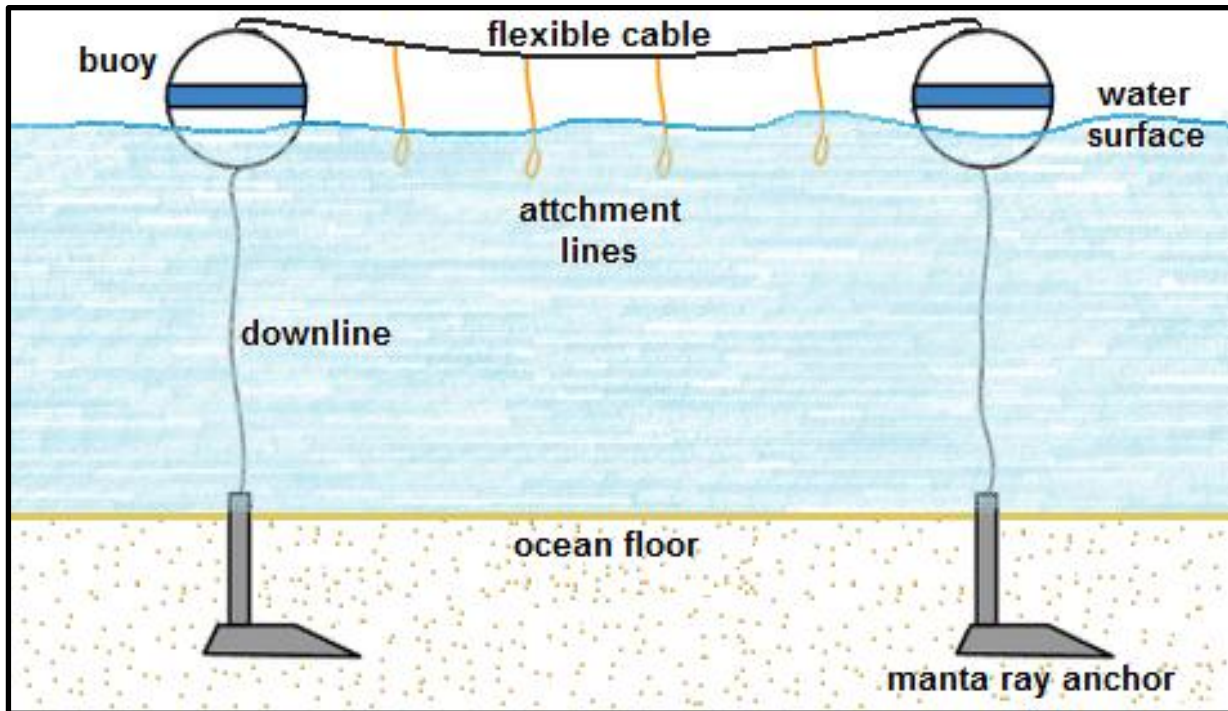

Figure 42: Original cable design created by Bouchard et al 2013. Components in this image are not drawn to scale.

This design was determined to be unfeasible when we learned that rafting moorings were meant to be built on existing mooring buoys. According to our liaison, distances between these buoys vary greatly and most if not all distances are too large to be spanned by a simple connection line. For example, buoys at Mosquito Pier in Vieques have an average distance of 392 feet in between them. This distance was measured using a *Google Earth* file containing all buoy locations given to us by the DRNA (A. Velazco, Personal Communication, 2014). The design was altered to try and shorten this gap in order to standardize buoy distances. Figure 43 is a drawing showing a modified rafting mooring design with the addition of ring links to account for this problem by connecting the down lines of the buoys at a shorter distance apart than in the previous design. We call this the ring link design.

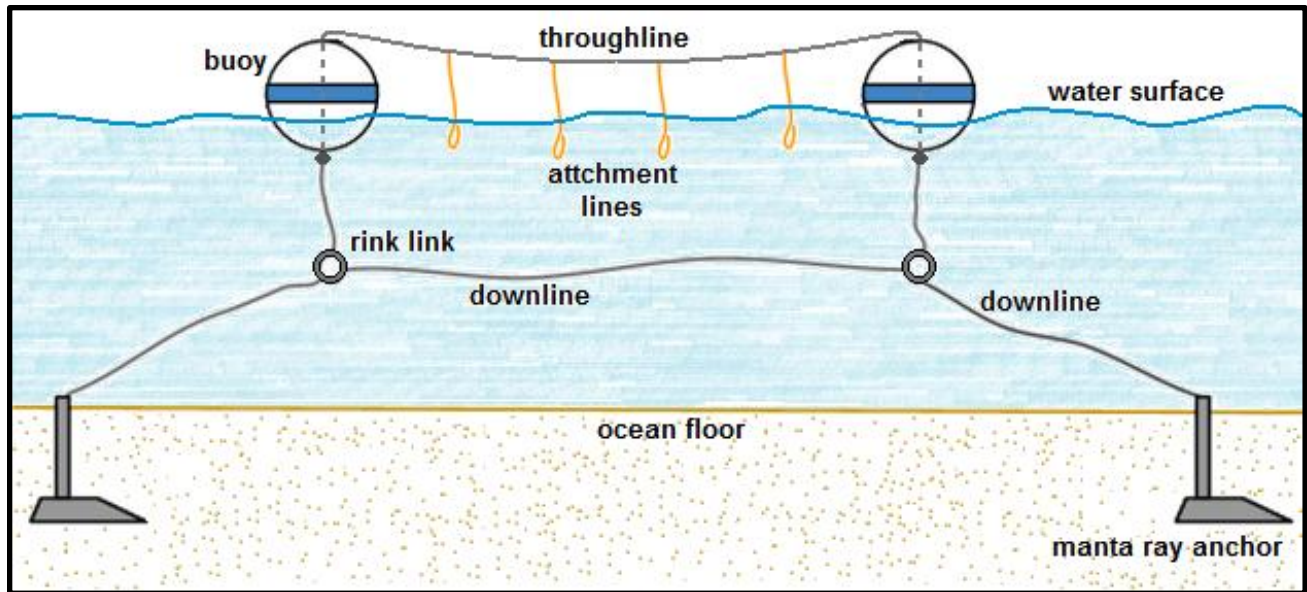

Figure 43: Ring link design; components in this image are not drawn to scale.

The design in Figure 43 was created as a solution to the problem of buoys being too far away. With the connecting rope joining the two rings, the buoys can be brought to whatever distance we calculate to be reasonable to hold five boats. This data was obtained from the previous section. However, this raised another issue. Standardizing the distance between buoys could result in more strain being put on the anchors, especially as the anchor distances get farther apart. To fix this, we created the design depicted in Figure 44. This design is called the helix design.

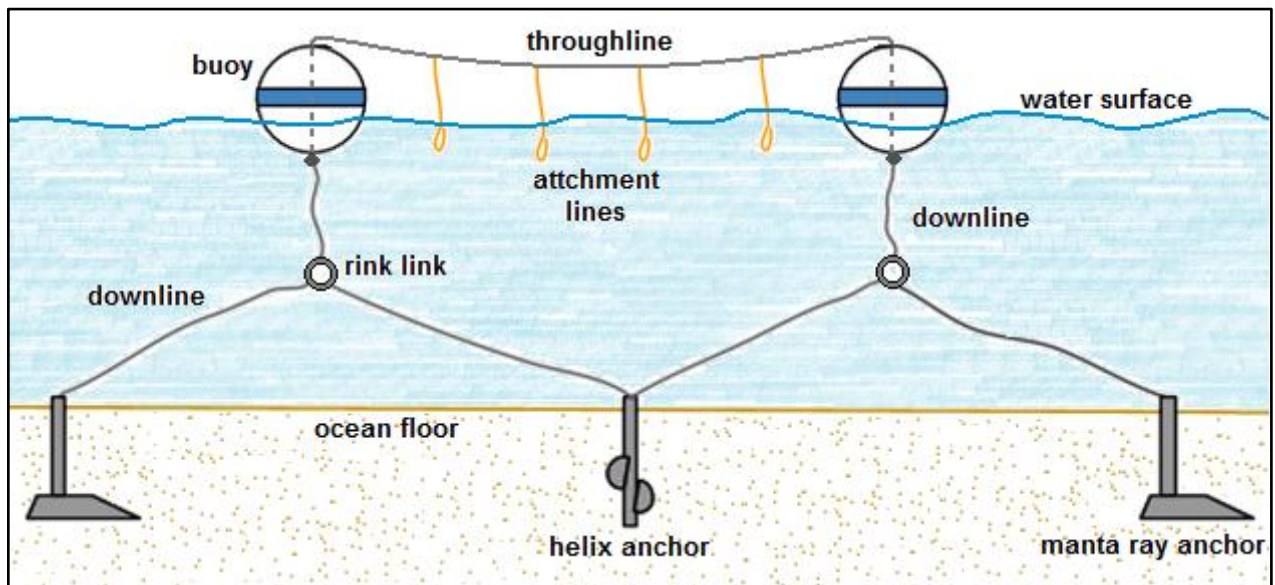

Figure 44: Helix anchor design; components in this image are not drawn to scale

This design features a Helix mooring anchor in the middle of the two Manta Ray mooring anchors. The helix anchor acts as a support to reduce the strain on the Manta Ray anchors, because the force is distributed over the three anchors. Helix anchors were chosen because of their ease of installation and high carrying capacity (amount of weight it is able to endure without failure) of around 20,000 lbs (National Oceanic and Atmospheric Administration, 2005).

Figure 45 depicts our rope design. This design is a simpler version of the others, as it only uses an additional rope to connect the buoys above the surface, but it is still capable of shortening and standardizing the distances between buoy. Because there are minimal underwater components, this design would be useful in shallow water, where there is little room for slack lines that would drag on the floor.

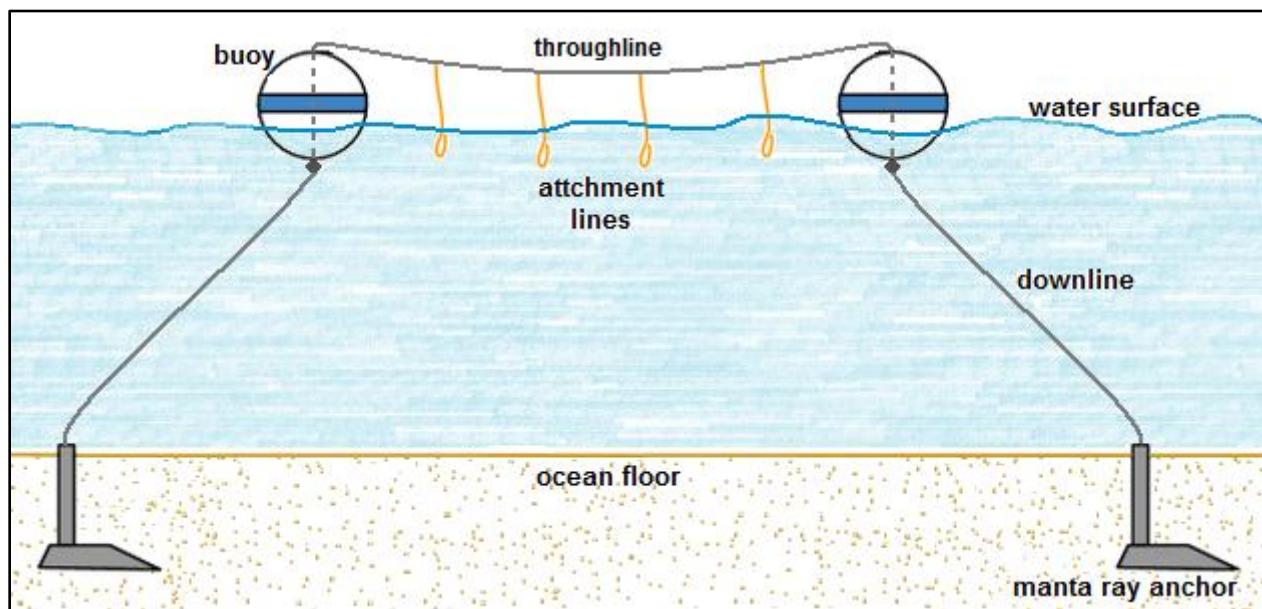

Figure 45: Rope design; components in this image are not drawn to scale.

In the next this design, the mooring is free to rotate as the wind changes. This design is called the swivel design. Current mooring buoys allow for rotational movement because they only have one anchor. The addition of the double-eye swivel ring allows for movement about the center axis of the system. This would be helpful in locations where wind is variable, as it would decrease torque stress on the rafting mooring due to wind. Because the buoy downlines come together to a single point, a metal rod was placed to permanently separate buoys so they do not float together. This rod would be padded so it does not scrape against the bows of boats. Figure 46 shows our swivel design

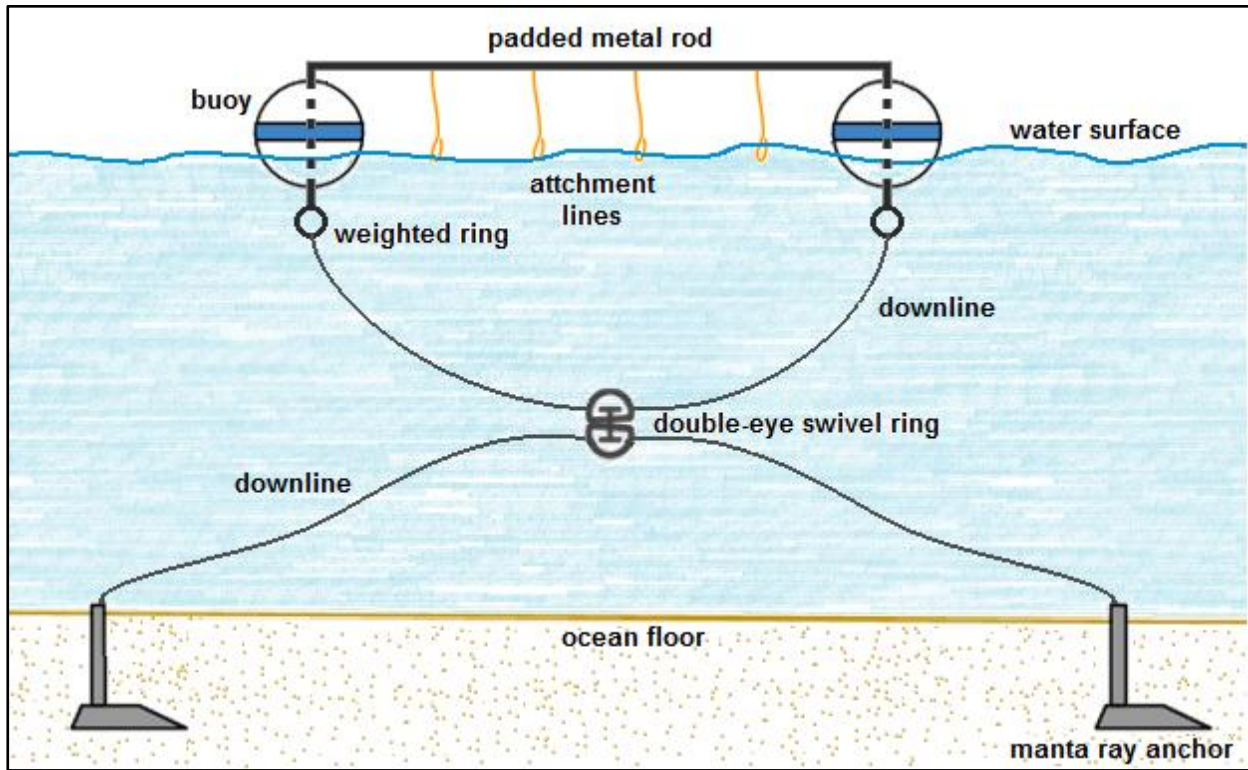

Figure 46: A modified design with double-eye swivel ring; components in this image are not drawn to scale

Figure 47 shows an enlarged image of a double-eye swivel ring that would be used for the swivel design. The double-eye swivel ring is made of hot-dip galvanized steel.



Figure 47: A double-eyed swivel ring

4.2.2 SolidWorks parts

We transformed our final design into a 3D model. First, the individual components had to be constructed using SolidWorks. Once all of the parts were created, they were then assembled to create the designs mentioned in section 4.2.1 Preliminary drawings.

In SolidWorks we created a buoy that replicated a DRNA buoy. In the beginning of our project, the exact dimensions of the mooring buoy were not known. Because of this, we had to make a generalized design of a buoy. To do this, we researched the specifications of mooring buoys, including factors such as the dimensions and weight of each component, so that a final mooring buoy could be chosen. We identified a marine supplies store online, *Boatersland Discount Marine Supplies*, which sells multiple mooring buoys that looked exactly like the DRNA mooring buoy, white with a blue stripe around the middle of the buoy. It was found that, on average, the size of a mooring buoy ranges from 12 inches to 30 inches (Boatersland, 2014). The mooring buoys we used for our preliminary designs are called Taylor Made Sur-Moor T3C Mooring Buoy. A specifications chart for can be seen below in Table 11.

Table 11: Technical specifications of Taylor Made mooring buoy (Taylor Made Sur-Moor T3C Mooring Buoys, 2008)

Item No.	Buoy Diameter	Tube Diameter	T3C Mooring Collar	Approx. Buoyancy
TAY-46370	12 inches	2 inches	TAY-33020 -- 2 inch	30 lbs.
TAY-46371	15 inches	2 inches	TAY-33020 -- 2 inch	60 lbs.
TAY-46372	18 inches	2-1/2 inches	TAY-33025 -- 2-1/2 inch	100 lbs.
TAY-46374	24 inches	2-1/2 inches	TAY-33025 -- 2-1/2 inch	240 lbs.
TAY-46375	30 inches	3 inches	TAY-33028 -- 3 inch	460 lbs.

In the table above the buoy diameter represents the size of the buoy. The tube diameter is the size of the opening of the tube. The tube is a hole that goes through the center of the T3C Buoy for attachment of a rope. The T3C Mooring Collar is a hot-dip galvanized steel collar that protects the buoy from anchor-chain wear. The approximate buoyancy is the amount of weight the buoy can with withstand before it sinks (Boatersland, 2014).

As a general rule, the *Boatersland Discount Marine Supplies* store recommended that a customer should select a buoy that offers slightly more than twice the amount of floatation that is required for the weight of the anchor chain or rope used (Boatersland, 2014). As an example, 50 pounds of anchor chain will require a buoy with a floatation rating of slightly over 100 pounds. We assumed that our downline will be around this weight, but it depends on the length and material used. However, the amount of floatation needed will be more than 100 pounds to accommodate the rope or wire that will connect the mooring buoys together. The 24 inch mooring buoy was chosen because of the larger size and also because it has approximately 240 pounds of buoyancy.

All of the specifications for the 24 inch mooring buoy, except for the T3C mooring collar dimensions, were used in creating the 3D model on SolidWorks. This was because the T3C mooring collar is not directly a part of the mooring buoy itself. We were also not sure if the DRNA's mooring buoys have this so we did not put it into the design. Another specification we used was that the T3C buoys are made out of a polyethylene shell. This hard skin mooring buoy is

made to withstand long periods of time in the water and exposure to sunlight (Boatersland, 2014). In SolidWorks, we were able to change the material of the buoy design to be polyethylene. Below are multiple views of the mooring buoy we created on SolidWorks. Figure 48 shows an opaque view of the mooring buoy. Figure 49 shows a translucent view of the buoy where all edges of the mooring buoy including the edges that are hidden from the current view are displayed with gray dotted lines. These specific edges are displayed with gray dotted lines. Once we got the actual dimensions of the buoy from the DRNA, changing the design was very simple. We just went back to the original 2D sketch and changed the values. The size of the buoy that the DRNA uses is 18 inches.

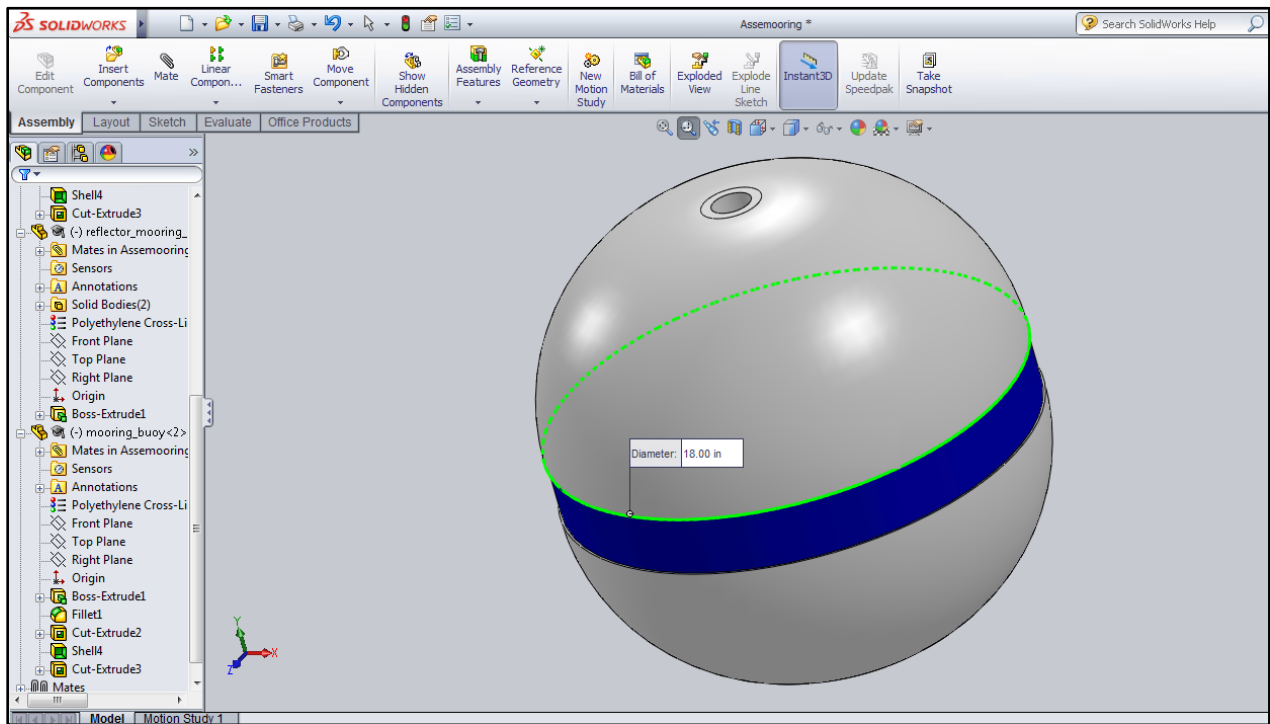

Figure 48: Opaque mooring buoy

Figure 49 shows a transparent mooring buoy with its hidden lines visible.

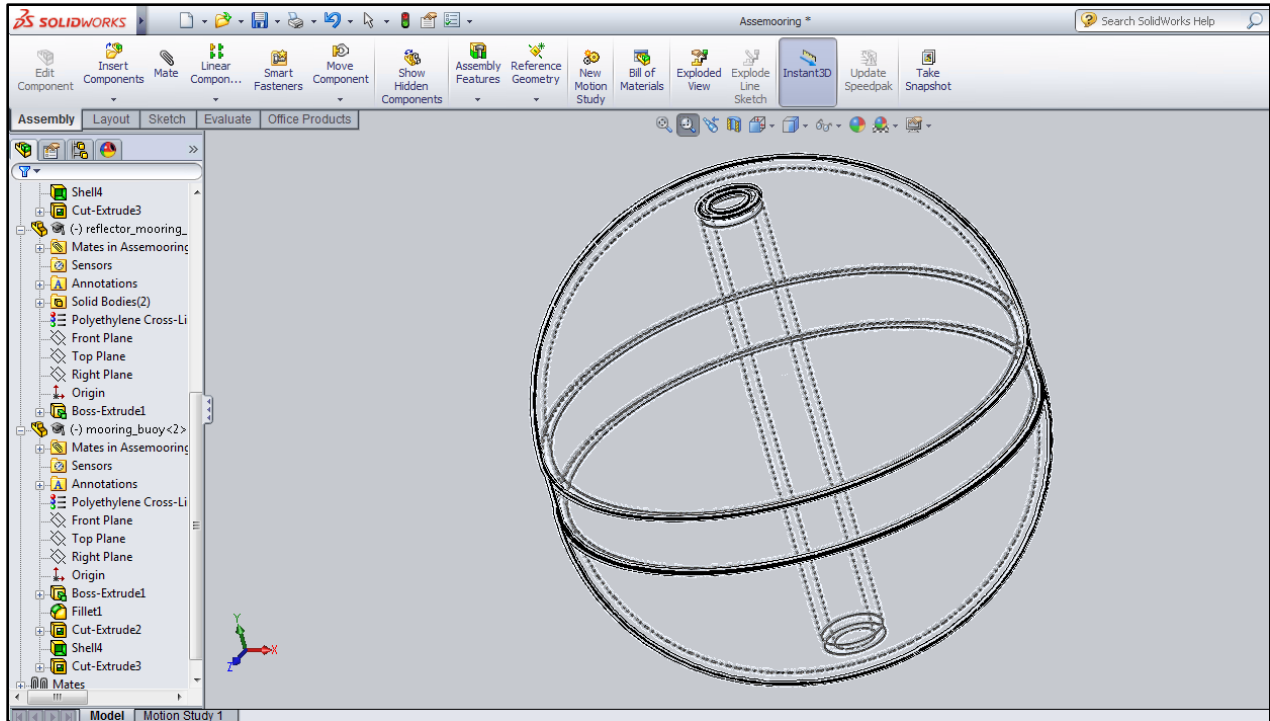

Figure 49: Transparent mooring buoy with the hidden lines visible

Along with the physical design of the system, we also included boats to show how they would interact with our mooring buoys. We downloaded the boat below from GrabCAD; we did not design a boat specifically for this project because it is not an actual part of the mooring buoy design itself. (<https://grabcad.com/library/motorboat-runabout-8-7m-1>). The boat(s) represented the overall mass that the rafting mooring supported during the simulations. We wanted to create the scenario that would produce the most tension. Therefore, each boat used in the simulations of the rafting mooring buoy design was designated as a class 4 boat. This type of boat has a displacement of approximately 37,479 pounds (LC Média, 2014). Figure 50 shows a standard motor boat.

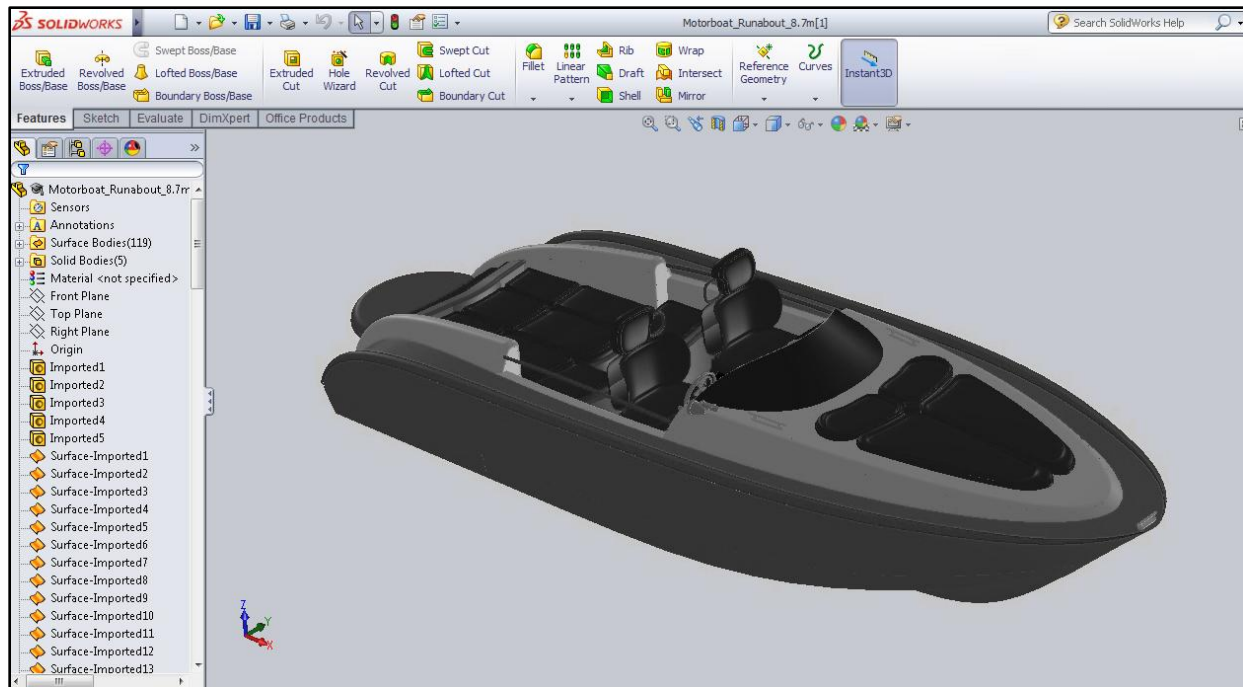

Figure 50: A standard boat (Vlad, 2014)

Another part needed was the cleat of the boat, which is the structure on the boat to which the rope is tied. The rope is then used to tie the boat to another boat, a mooring buoy or a dock in order to remain stationary. Although it did not undergo significant tension in the simulations, it was important to include in the SolidWorks designs because boaters used the cleat and rope to raft together. Figure 51 shows an enlarged image of the cleat.

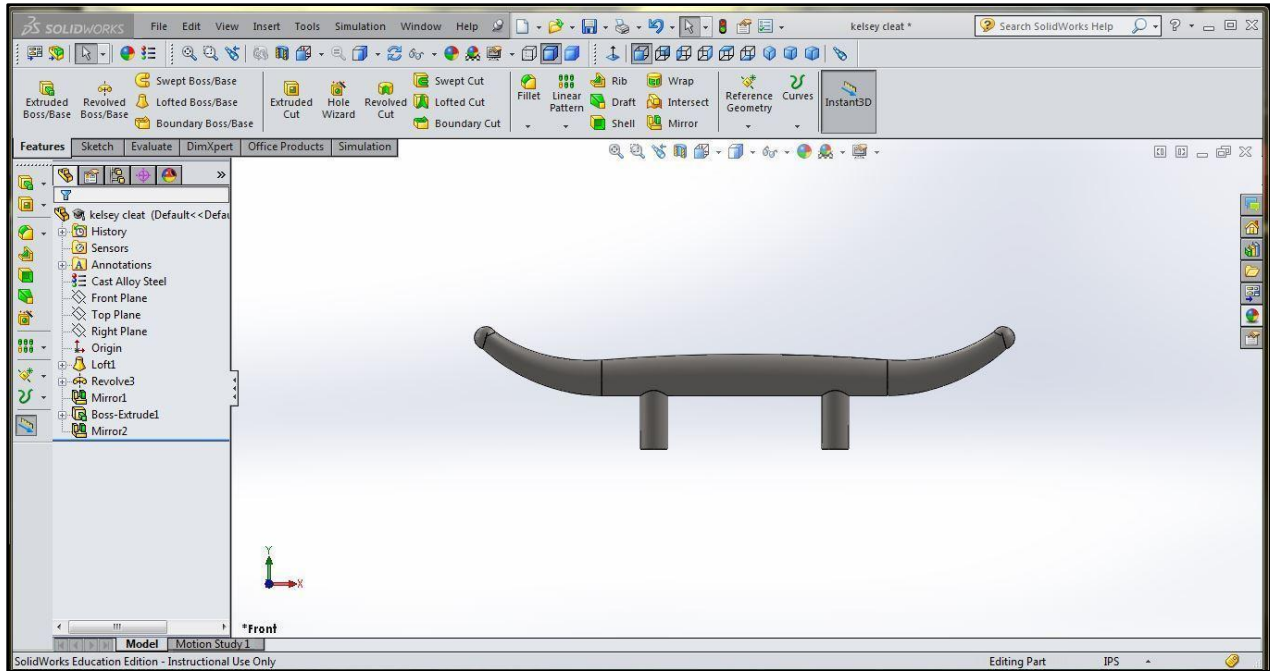

Figure 51: A cleat for the boat

One of the most complex parts that we created is the Manta Ray anchor. We used the information that Edwin Rodriguez gave us to do this. The Manta Ray anchor used is the MR-SR3, with an anchor rod of one by seven inches (see Appendix O). Figure 52 shows the MR-SR3 Manta Ray anchor.

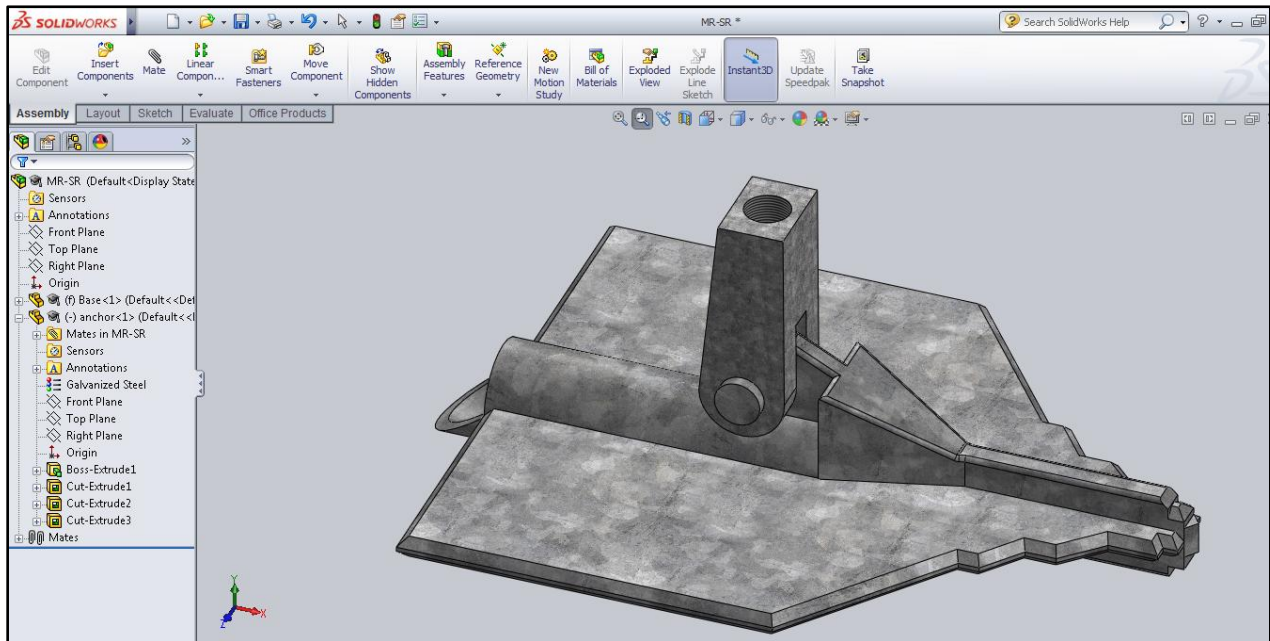

Figure 52: The MR-SR3 Manta Ray anchor

4.3 Feedback from stakeholders

We received results from our second survey (see Appendix P) that we sent out to the *La Regata* subscribers and to the boaters whose emails we received from the first survey we gave out. These boaters specifically said that they had interest in seeing the rafting mooring design. We received a total of 50 responses to this survey.

Figure 53 shows the mean scores of the chart that asked questions about comfort and ease-of-use of both of the rafting mooring designs. A score of 1 correlates with “very difficult” and a score of 5 correlates with “very easy” for the first two questions. A score of 1 correlates with “very uncomfortable” and a score of 5 correlates with “very comfortable” for the last two questions. For the first three questions, n=45 and for the last question, n=44. The stand error of all of these questions is 1.47.

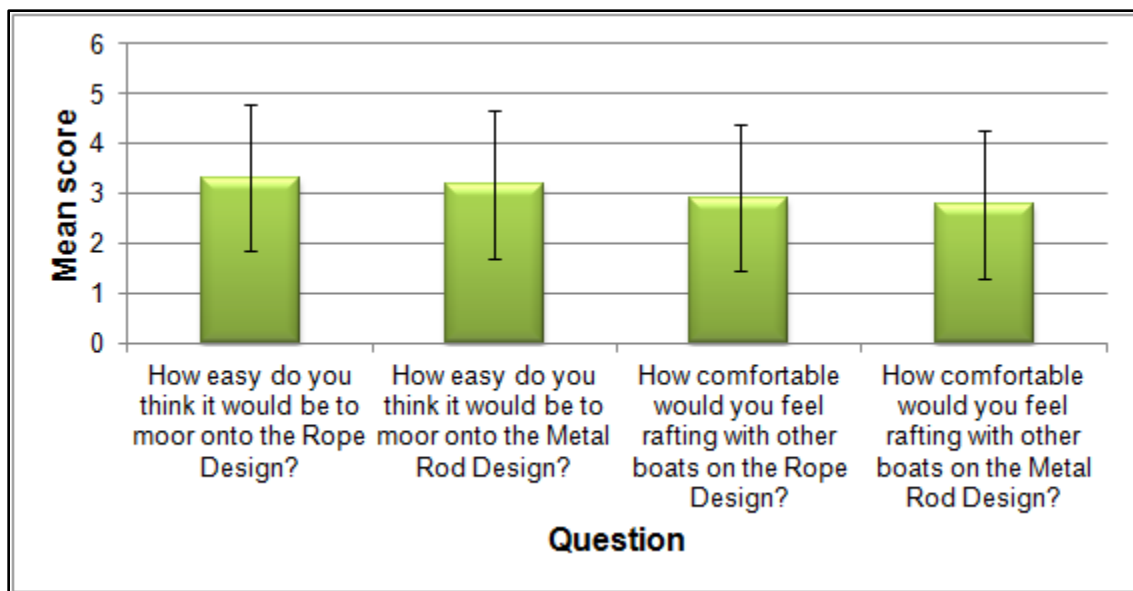

Figure 53: Average mean scores for the chart with questions relating to ease-of-use and level of comfort of the designs presented; for the first three statements, n=45 and for the last statement n=44 (note that a mean score of 1 coincided with “very difficult” for the first two statements and “very uncomfortable” for the last two statements; 5 coincided with “very easy” for the first two statements and “very comfortable” for the last two statement)

The first statement received an average score of 3.31, with a standard deviation of 1.482 and a variance of 2.21. The second statement had a mean score of 3.18 with a standard deviation of 1.42 and a variance of 2.02. The third statement received an average score of 2.91, with a variance of 2.446 and a standard deviation of 1.562. Finally, the fourth statement had a mean score of 2.77 with a variance of 2.01 and a standard deviation of 1.42.

These results overall were inconclusive. The mean scores for the ease of use and comfort for both designs differed by only 0.16 and 0.14 respectively. Since the averages of all statements were around 3, this means that we could not definitely confirm if respondents believed that either design would be easy to use, or if the respondents felt comfortable using the design while rafting with other boats.

The next three questions were free response questions. Raw data for these questions can be seen in Appendix P. Question 2 asked about how we can mark rafting moorings to make them distinguishable amongst regular mooring buoy. This question received 35 total responses. The overwhelming response for this question was to make the buoys a different color, as 66% of respondents said to make the buoys a different color. Making the buoys used in rafting mooring a different color would be both easy and inexpensive. Another popular response was to add small flags to the two buoys. This method would also be inexpensive, but would be more complicated than changing the color of the buoys since the buoys would need to be taken apart so that flags could be inserted inside of the buoy.

From these results, changing the color of the buoys used in the rafting mooring would be most effective for both boaters and the DRNA. This would make it easy for boaters to distinguish between single-use mooring buoys and rafting mooring buoys. Painting the buoys would also be very cost-effective for the DRNA.

Question 3 asked about what could be added or changed to make the boaters feel more comfortable to use either of the rafting mooring designs. This question received 26 total responses. One trend that we noticed was that respondents are skeptical of the metal rod design because the metal may corrode in the ocean. Some respondents recommended using a stainless steel rod to solve this issue. Many respondents wanted to also know the average distance between the buoys. Because the distances between buoys vary in all locations, it would be difficult to relay this information to them. Another common response was to have regular maintenance on the rafting moorings. This indicates that boaters may not be aware that maintenance is being conducted on the current mooring buoys. The DRNA's overall maintenance schedule varies by location (see Appendix O).

Based on the results from this question, we recommend that the DRNA makes their current maintenance plan available to the public. Even though maintenance of mooring buoys

varies by location, it would be helpful to boaters if they knew when buoys are maintained. This would make boaters feel more comfortable using mooring buoys if they know when mooring buoys have been repaired or inspected. Then boaters would know for sure which mooring buoys are the safest to use without the risk of damaging their boats or the actual mooring buoys. Perhaps this could be done by creating an application (app) with all the mooring buoy locations. Not only would this app have information regarding the distances between mooring buoys but with this app, DRNA personnel can update the time and date of when each individual mooring buoy was last inspected. This app would be a quick, easy, and an effective way to relay information regarding when each mooring buoy was last inspected. The app can also explain exactly which parts of the mooring buoy were repaired.

The last free response question asked respondents to give suggestions on what additional information that would make them feel comfortable about using the rafting mooring. For this question, the total responses were 29. One common response was to have data on the capacity of rafting moorings easily accessible to the public. This may cause boaters to feel more comfortable using the rafting if they knew exactly how much weight the rafting mooring could successfully sustain without failure. Another interesting suggestion is to have a telephone number on the buoys that boaters could call whenever damage is sustained to the mooring buoys. Finally, the last recommendation which may prove useful is to specify which types and sizes of boats could use the rafting mooring.

From these findings, we recommend to include the DRNA's telephone number on the mooring buoy app previously discussed in this section. This number can be called when a mooring buoy is damaged so it can quickly be repaired. The app can also include the strength of the rafting mooring to make boaters feel more comfortable using mooring buoys. From the previous survey, we learned that boaters are more likely to use mooring buoys if they feel comfortable using them.

Figure 54 shows the mean scores for question 5, which asked respondents to rank statements (from 1-5) about rafting mooring specifics. A ranking of 1 is associated with "strongly disagree" and a ranking of 5 is associated with "strongly agree". For the first statement, n=43 and for the second and third statements, n=44. These results have a standard error of 1.16.

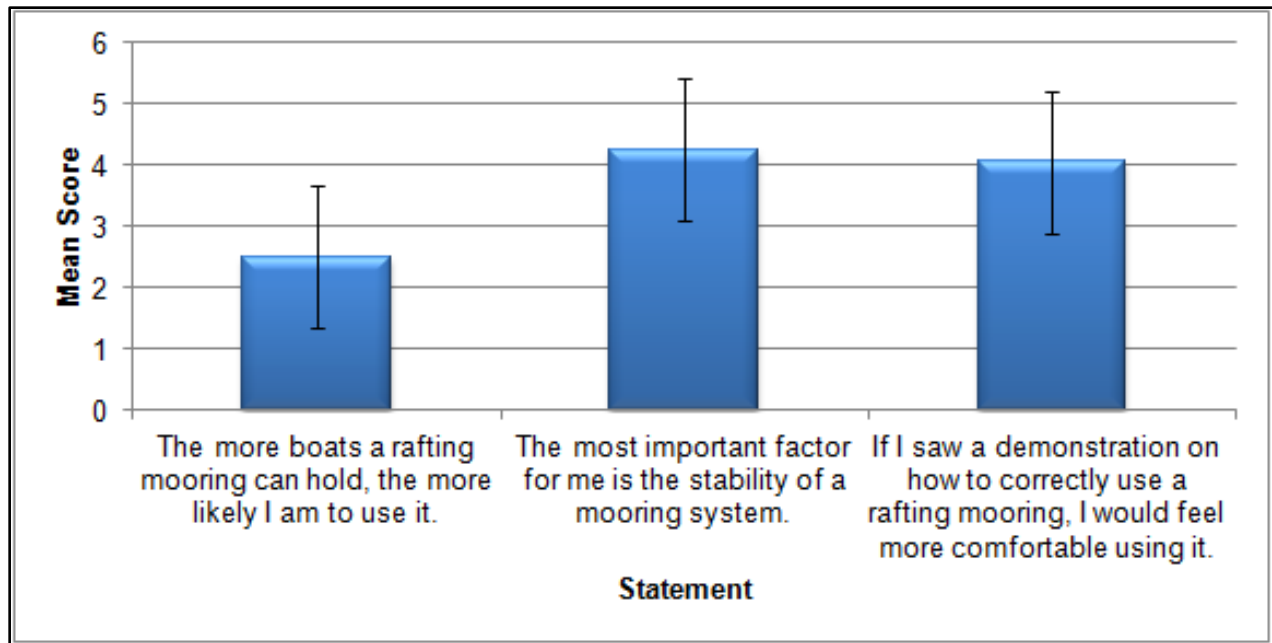

Figure 54: The mean scores for question 5, 1 is associated with “strongly disagree” and 5 is associated with “strongly agree”; for the first statement, n=43 and for the second and third statements, n=44; these mean scores have a standard error of 1.16

The first statement about the amount of boats a rafting mooring can withstand received a mean score of 2.49 with a variance of 1.23 and a standard deviation of 1.09. The second statement about stability of mooring buoys received a mean score of 4.25 with a variance of 1.38 and a standard deviation of 1.17. The last statement about a rafting mooring demonstration had an average score of 4.05 with a standard deviation of 1.22 and a variance of 1.47.

From the results from this statement inferred that strength is a very important factor for the overall design. Respondents did not care as much about the total number of boats that the rafting mooring could sustain. Instead, what matters to the respondents is being secure while attached to the rafting mooring. Therefore in our value analysis, strength was the most important factor. Additionally, respondents are very interested in seeing a demonstration of a rafting mooring to make them feel more comfortable using them.

Overall, this survey was very helpful in obtaining information needed for the future of this project. A mooring buoy app would be very helpful in promoting its use. This app can include all of the specific locations of mooring buoys so people know the precise locations of mooring buoys along with the distances between them. Maintenance schedules could also be uploaded to this app. Each mooring buoy could have information about the date when the mooring buoy was last

inspected and what part(s) were replaced if needed. Because boaters believe that strength is an important factor in a rafting mooring, we categorized strength as the most important factor in our value analysis. The strength of the rafting mooring and single-use mooring buoys can also be uploaded onto the mooring buoy app. Boaters may feel more comfortable using the rafting mooring if they know its exact strength. When rafting moorings are actually installed around Puerto Rico, the buoys should be painted a different color so boaters can distinguish between rafting moorings and regular mooring buoys. However before rafting moorings are installed, we recommend that the DRNA organizes a live demonstration on how to properly use a rafting mooring. After the video is edited properly, it can be uploaded to the DRNA website so the public may access it.

4.4 Comparison of designs

All of the designs were evaluated with the mooring buoy design value analysis chart. Designs were ranked in different categories, such as the overall cost and how easy the design is would be to install and maintain, but for all categories, low numbers indicate a poor score for that category, and high numbers indicate a strong score for that category. We also measured how easy it would be for users to use the rafting mooring and to distinguish our system from regular moorings. Through personal communication with Carlos Matos we learned the price for a 600 foot rope was \$365. Through calculations the price for a foot of rope was found to be \$0.61. Since the length of rope will differ due to the varying distances between buoys around the Puerto Rican cays, an exact cost for rope could not be determined. So we chose a standardized length of 200 feet. 130 feet dedicated for the throughline that connects the two buoys together, 30 feet dedicated for attachment lines, and 40 feet for down lines. This way each design that uses rope to connect the buoys would use all 200 feet. The design that uses a metal bar to connect the buoys would only use 70 feet of rope, while the rest of the 130 feet would be used for the length of the metal bar. Each design was given a final score that helped us to evaluate which design was superior.

Design 1: Ring link design

The only new parts that this design requires are more rope and two metal rings. The cost of 200 feet of rope is \$122. For the metal ring used in some of the designs, we were not able to find an exact price so we assume that the ring could not possibly be above \$10. From previous

research, the estimated total cost of the necessary materials would be about \$132. Thus, this would receive a score of 3, indicating that it would fall in the range of \$0-\$333. Using the value of 10,602 lbf for the maximum tension this design could withstand, which was determined by our calculations in section 3.4.2, the strength of this design was given a score of 3. From the results of the second survey we distributed, we found the average ranking for this design was 3.31 out of 5 (n = 27 with a standard deviation of 1.48) so it received a score of 2 in the value analysis, indicating it falls in the range of 2.6-3.75. Maintenance was considered decent resulting in a score of 1 because this design contained three additional components; the rope the connects the buoy, ring link and rope that connects the ring links. Since the rings and additional rope were new parts, the maintenance of these parts would have to be taught to the DRNA. This takes up time and money. Installation was given a score of 2. This was because this design had fewer than three new underwater components to be installed. Accordingly, this design received a total score 19 on the mooring buoy design value analysis, seen in Table 12.

Table 12: Design value analysis of the rope link design

Design Value Analysis	Ring link Design		
	Rank:	Score	Weighted Score
COST	1	3	3
STRENGTH	3	3	9
EASE-OF-USE	2	2	4
MAINTENANCE	1	1	1
INSTALLATION	1	2	2
TOTAL			19

Design 2: Helix Design

The new parts that this design requires are more rope, two metal rings and the helix anchor. The cost of 200 feet of rope is \$122. For the metal ring used in some of the designs, we were not able to find an exact price so we assume that the ring could not possibly be above \$10. The price of a helix anchor ranges from \$700-\$1,000 (see Appendix M). For this case we chose the \$1,000 because it is the worst case scenario. From this we calculated the estimated total cost

of the necessary materials to be about \$1,132. Thus, this would receive a score of 0, indicating it falls in the range of more than \$1,000. Using the value of 15,904 for the maximum tension this design could withstand, which was determined by our calculations in section 3.4.2, the strength of this design was given a score of 3. From the results of the second survey we distributed, we found that the average ranking for this design was 3.31 out of 5 (n = 27 with a standard deviation of 1.48) so it received a score of 2 in the value analysis, indicating it falls in the range of 2.6-3.75. Maintenance was considered complex resulting in a score of 0 because this design contained more than three additional components; two additional downlines, two rings and a helix anchor. Since the rings and additional rope were new parts, the maintenance of these parts would have to be taught to the DRNA. This takes up time and money. Installation was given a score of 1. This was because this design had more than three new underwater components to be installed and according to Carlos Matos, the helix anchors take time and muscle to install. Accordingly, the first design had a total score 14 on the mooring buoy design value analysis, seen in Table 13.

Table 13: Design value analysis of the helix design

Design Value Analysis	Helix Design		
	Rank:	Score	Weighted Score
COST	1	0	0
STRENGTH	3	3	9
EASE-OF-USE	2	2	4
MAINTENANCE	1	0	0
INSTALLATION	1	1	1
TOTAL			14

Design 3: Rope design

The only new part that this design requires is more rope. The cost of 200 feet of rope is \$122. So the estimated total cost of the necessary materials to be about \$122. Thus, this would receive a score of 3, indicating it falls in the range of \$0-\$333. Using the value of 10,602 lbf for the maximum tension this design could withstand, which was determined by our calculations in section 3.4.2, the strength of this design was given a score of 3. From the results of the second

survey we distributed, we found that the average ranking for this design was 3.31 out of 5 (n = 27 with a standard deviation of 1.48) so it received a score of 2 in the value analysis, indicating it falls in the range of 2.6-3.75. Maintenance was considered simple resulting in a score of 3 because there are no new parts that need to be maintained. Installation was given a score of 3. This was because it requires minimum effort from the DRNA because it is just adding a new long rope. Accordingly, the rope design had a total score of 22 in the mooring buoy design value analysis, seen in Table 14.

Table 14: Design value analysis of the rope design

Design Value Analysis	Rope Design		
	Rank:	Score	Weighted Score
COST	1	3	3
STRENGTH	3	3	9
EASE-OF-USE	2	2	4
MAINTENANCE	1	3	3
INSTALLATION	1	3	3
TOTAL			22

Design 4: Swivel design

The new parts that this design requires are a metal rod, more rope, and double-eye swivel ring. For this design instead of having 200 feet of rope, there are 70 feet of rope and 130 feet of metal bar. So the cost of 70 feet of rope is about \$42.70. For the metal rod used in this designs, we were not able to find an exact price so we assume that the rod could not possibly be above \$10 for 1 foot. Thus, for 130 feet the price for the metal rod was \$1,300. For the double-eye swivel ring used in this designs, we were not able to find an exact price so we assume that the ring could not possibly be above \$10. From this we calculated the estimated total cost of the necessary materials to be about \$1,384. Thus, this would receive a score of 0, indicating it falls in the range of more than \$1,000. Using the value of 10,602 for the maximum tension this design could withstand, found which was determined by our calculations in section 3.4.2, the strength of this design was given a score of 3. From the results of the second survey we distributed, we found the average

ranking for this design a 3.11 out of 5 ($n = 27$ with a standard deviation of 1.42) so it received a score of 2 in the value analysis, indicating it falls in the range of 2.6-3.75. Maintenance was considered complex resulting in a score of 0 because it contained more than three additional components; a metal rod, 2 additional downlines, and a double-eye swivel ring. Since, the ring, additional rope, and rod were new parts, the maintenance of these parts would have to be taught to the DRNA staff. This takes up time and money. Installation was given a score of 1. This was because this design had fewer than three new underwater components to be installed, but two install the metal rod may be complicated. Accordingly, the first design had a total score of 14 on the mooring buoy design value analysis, seen in Table 15.

Table 15: Design value analysis of the swivel design

Design Value Analysis	Swivel Design		
	Rank:	Score	Weighted Score
COST	1	0	0
STRENGTH	3	3	9
EASE-OF-USE	2	2	4
MAINTENANCE	1	0	0
INSTALLATION	1	1	1
TOTAL			14

When looking at the value analyses for each of the different designs, we concluded that the rope design was the best because it had the highest total score, meaning that it would be the best for the DRNA to implement.

4.4.1 Final SolidWorks design

Once we choose the rope design for the final design we used the 3D parts made earlier seen in section 4.2.2 SolidWorks parts. This design, seen in Figure 55 is meant to be used for a visual aid, but in the future could be used for simulations.

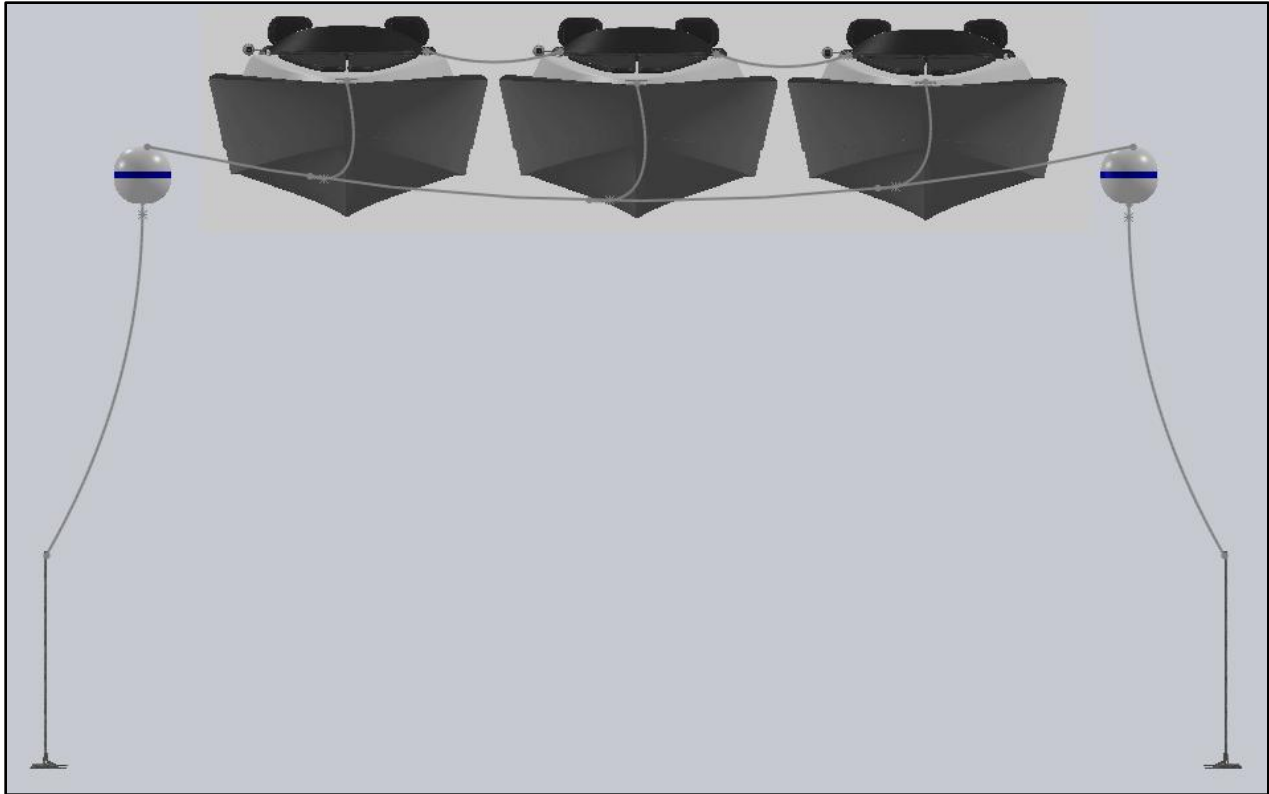

Figure 55: The final 3D SolidWorks model of the rope design

Even though the design was created to sustain a given load through Excel, the design still needs to undergo field testing to verify that the rafting mooring would work. Our methods mainly focused on theoretical calculations and value analysis to determine the best design. However, before a design cannot be completely finalized until the DRNA carries out physical field tests. **We recommend that the DRNA should build a prototype of our design and experiment on how it works under different loads. To complement field tests, simulations on computer software should be done as well.** One possible field testing location that was mentioned was Boquerón. However, due to lack of permits this was not possible. If permits are available in the coming years, the DRNA should physically construct our design and test it for strength. They should also focus on locating fatigue points, and observe the behavior of the prototype under varying pressures. **This will help in eliminating errors from our designs, or any future designs for the rafting moorings.**

4.5 Strategic plan

The fifth and the final part of this project was creating a strategic plan for the DRNA. This consisted of an installation component and a promotion component. The installation component is an outline for how DRNA should install and maintain the new systems, while the promotion plan consists of recommendations on how the DRNA should promote the systems. We created both components of the plan the results from our surveys, interviews, informal conversations with the DRNA personnel and research. This plan can be seen in Appendix Q.

5.0 Conclusion

With our background research, informal interviews, and our results from our surveys we were able to deduce that the rope design would be best suited for the Puerto Rican cays. The rope design received the highest overall score in our mooring buoy design value analysis. Through our methods, this design proved to be cost-effective when compared to other mooring buoys that we have previously researched, and maintainable for the DRNA to conduct as necessary. We were able to present the rope design to the DRNA to explain how it could be used by a maximum of 7, 40-foot boats because it can support an estimated load of 10,602 pounds. This rafting mooring buoy could provide to be very effective and applicable to the Puerto Rican cays. Not only would this design prevent anchoring, but it would also allow for rafting amongst boaters. Therefore both major stakeholder groups (the DRNA and the boaters) are satisfied. Before this rafting mooring buoy can be successfully installed, a number of other tests and protocols must be conducted. We have created a list of recommendations for the DRNA to complete prior to initiating the rafting mooring buoy installation process.

We recommend that before the installation of the rafting mooring buoy occurs, that the DRNA conducts field testing to be sure that this rafting mooring design works properly. Because our calculations were simplified, additional calculations may be needed. Our SolidWorks design can easily be tested under various SolidWorks simulations, and perhaps a professional mechanical engineer can conduct simulations on our design. We also recommend that anchoring laws should be enforced by using a warning system. Where the punishments for the offense gradually become stricter depending on the number of violations a boater commits.

We also suggest that the DRNA creates a map of all existing mooring buoys, since boaters do not know of all mooring buoy locations. This map can be included online for easy access and at local marinas as a part of a brochure. We also believe that making an app with all of the mooring buoys would be successful and helpful to boaters. On this app, each mooring buoy can be updated to say exactly when they were last updated and how (which parts were repaired). This app will also help promote the rafting mooring and single-use moorings, and will make boaters feel more comfortable using mooring buoys, which will increase their overall use.

6.0 Bibliography

ACRI-In co (2014). *Design & Build: Study, design, build maritime structures in France and around the world*. Retrieved from <http://www.acri-in.fr/en/acri-in-bureau-etudes-amenagement-littoral-services/acri-in-products>

Allen, W. H. (1992). Increased dangers to Caribbean marine ecosystems. pp. 330-335. In *Bioscience*. pp 965. American Institute of Biological Sciences. Retrieved from [http://www.denix.osd.mil/nr/crid/Coral_Reef_Iniative_Database/Anchor_Boat_Damage_files/All en,%201992.pdf](http://www.denix.osd.mil/nr/crid/Coral_Reef_Iniative_Database/Anchor_Boat_Damage_files/All%20en,%201992.pdf)

Batista, T. (2014). *CFMC Fishery Management Plans*. Retrieved from http://caribbeanfmc.com/fmp_corals.html

Bouchard, T., David, L., Victor, P., Shooter, M. (2013). *Nautical Community Mooring Buoy Utilization in Puerto Rico*. Worcester, MA: Worcester Polytechnic Institute. Retrieved from http://www.wpi.edu/Pubs/E-project/Available/E-project-050213-210509/unrestricted/Nautical_Community_Mooring_Buoy_Utilization_in_Puerto_Rico.pdf

Boatersland Discount Marine Supplies. (2014). Retrieved from <http://www.boatersland.com/t3cmooring.html>

Bruckner, A. W. (2002). Life-Saving Products from Coral Reefs. pp. 39-44. In: *Issues in Science and Technology*. Retrieved from <http://reinat.com/lpmnm/introduction/lifesavingproductsfromcoralreefs.doc>

Burger, J. (2004). Fish consumption advisories: knowledge, compliance and why people fish in an urban estuary. pp. 463-479. In: *Journal of Risk Research*. Retrieved from <http://www.tandfonline.com/doi/abs/10.1080/1366987031000074159>

Causey, B., Delaney, J., Diaz, E., Dodge, R. E., Garcia, J. R., Higgins, J., Turgeon, D. D. (2002). The status of coral reefs in the US Caribbean and Gulf of Mexico: Florida, Texas, Puerto Rico, US Virgin Islands and Navassa. In: *Status of Coral Reefs of the World: 2000* (14). Retrieved from http://nsuworks.nova.edu/occ_facreports/10/

Cesar, H., Burke, L., & Pet-Soede, L. (2003). *The Economics of Worldwide Coral Reef Degradation*. Retrieved from <http://eprints.eriub.org/48/>

Cinner, J. E., McClanahan, T. R., Daw, T. M., Graham, N. A., Maina, J., Wilson, S. K., & Hughes, T. P. (2009). Linking social and ecological systems to sustain coral reef fisheries. pp. 206-212 In: *Current Biology*. Retrieved from <http://www.sciencedirect.com/science/article/pii/S0960982208015728>

Coffey, G., Greer, E., LaSante, R., & McNally, B. (2009). *Assessment and Catalogue of Puerto Rican Mooring Buoys*. Worcester, MA: Worcester Polytechnic Institute. Retrieved from https://www.wpi.edu/Pubs/E-project/Available/E-project-050509-131649/unrestricted/IQP-DNR2_5-5-09.pdf

Cooper, L., Schaefer Zarske, M., & Carlson, D. (2008). Hands-on Activity: Design Step 4: Engineering Analysis. Retrieved from https://www.teachengineering.org/view_activity.php?url=collection/cub_/activities/cub_creative/cub_creative_activity4.xml

Coral Reef Care. (2011). *Coral Bleaching*. Retrieved from <http://coralreefcare.wordpress.com/2012/12/31/coral-bleaching/>

Departamento de Recursos Naturales y Ambientales (DRNA). (2006) *Evaluation of Recreational Boating Anchor Damage on Coral Reefs and Seagrass Beds*. Commonwealth of Puerto Rico (F-27.16).

Departamento de Recursos Naturales y Ambientales (DRNA). (2013) *Evaluation of Recreational Boating Anchor Damage on Coral Reefs and Seagrass Beds*. Commonwealth of Puerto Rico (F-27.21).

Dinsdale, E. A., & Harriott, V. J. (2004). Assessing anchor damage on coral reefs: a case study in selection of environmental indicators. pp. 126-139. In: *Environmental Management*. Retrieved from <http://link.springer.com/article/10.1007/s00267-003-3056-9>

Duggan, M., & Brenner, J. (2013). *The demographics of social media users, 2012* (Vol. 14). Washington, DC: Pew Research Center's Internet & American Life Project. Retrieved from <http://www.lateledipenelope.it/public/513cbff2daf54.pdf>

García-Sais, J., Appeldoorn, R., Battista, T., Bauer, L., Bruckner, A., Caldow, C., Williams, S. (2008). The state of coral reef ecosystems of Puerto Rico. pp. 75-113. In: *The state of coral reef ecosystems of the United States and Pacific Freely Associated States: 2008*. 569 pp. Retrieved from <http://drna.gobierno.pr/oficinas/arn/recursosvivientes/costasreservasrefugios/coral/publicaciones/satus%20PR%20corals%202008.pdf>

Harvey, M. (2013). *Coral reefs: Importance*. Retrieved from http://wwf.panda.org/about_our_earth/blue_planet/coasts/coral_reefs/coral_importance

Hassan, L. M., Shiu, E., Walsh, G., & Hastings, G. (2009). Help –for a life without tobacco: a case study on demarketing across two levels. pp. 486-502. In: *Marketing Intelligence & Planning*. Retrieved from <http://www.emeraldinsight.com/journals.htm?articleid=1793439&show=abstract>

Hollander, A. (2011). Community-Based Social Marketing (Presentation). Retrieved from <http://www.osti.gov/scitech/servlets/purl/1009693>

Hubbell Power Systems. (2014). Chance Anchors. Retrieved from <http://www.hubbelpowersystems.com/catalogs/anchoring/04-ANCHORS.pdf>

International Union for Conservation of Nature (IUCN). (2004). *Managing Marine Protected Areas: A Toolkit for the Western Indian Ocean*. ICUCN Eastern African Regional Programme. Retrieved from <http://www.emeraldinsight.com/journals.htm?articleid=1793439&show=abstract>

Kercado, H., Ripolls, S., Garcia, M., & Berrios, J. (2008). *Evaluation of Recreational Boating Anchor Damage on Coral Reefs and Seagrass Beds Annual Progress Report Project (F-27.17, 1-14)*.

Khandani, S. (2005). *Engineering Design Process*. Retrieved from <http://www.saylor.org/site/wp-content/uploads/2012/09/ME101-4.1-Engineering-Design-Process.pdf>

LC Média. (2014). *The Boat Guide*. Retrieved from <http://www.guideautoweb.com/boat/>

Lu, J. T., Wu, H. J., Kong, G., Che, C. S., & Xu, Q. Y. (2006). Growth and corrosion behavior of rare earth film on hot-dip galvanized steel. pp. 1397-1401. In: *Transactions of Nonferrous Metals Society of China*. Retrieved from <http://www.sciencedirect.com/science/article/pii/S1003632607600272>

Maibach, E. (1993). Social marketing for the environment: using information campaigns to promote environmental awareness and behavior change. pp. 209-224. In: *Health Promotion International*. Retrieved from <http://www.emeraldinsight.com/journals.htm?articleid=1793439&show=abstract>.

Max Energy Ltd. (2007). *Puerto Rico*. Retrieved from http://www.solarnavigator.net/geography/puerto_rico.htm

McKenzie-Mohr, D. (2000). Fostering sustainable behavior through community-based social marketing. pp 531-537. *American Psychologist*. Retrieved from <http://psycnet.apa.org/journals/amp/55/5/531/>

Moorings. (2011). *BVI Marine Guide*. Published at www.shoresideservices.com. Retrieved from <http://www.bvimarineguide.com/moorings.html>

Nagelkerken, I., Van der Velde, G., Gorissen, M. W., Meijer, G. J., Van't Hof, T., & Den Hartog, C. (2000). Importance of mangroves, seagrass beds and the shallow coral reef as a nursery for coral reef fishes, using a visual census technique. pp 31-44. In: *Estuarine, Coastal and Shelf Science*. Retrieved from http://www.denix.osd.mil/nr/crid/Coral_Reef_Initiative_Database/Caribbean_Sea_files/Nagelkerken%20et%20al.,%202001.pdf

National Oceanic and Atmospheric Administration. (2005). *Mooring Buoy Planning Guide*. Rancho Santa Margarita, CA: International PADI, Inc. Retrieved from http://coralreef.noaa.gov/education/educators/resourcecd/guides/resources/mooring_buoy_g.pdf

National Oceanic and Atmospheric Association. (2010). *What are the three main types of coral reefs?* Retrieved from <http://oceanservice.noaa.gov/facts/threecorals.html>

National Park Service U.S. Department of the Interior. (2014). *Mariner's Resource Protection Guide*. Retrieved from <http://www.nps.gov/viis/planyourvisit/upload/MooringGuide.pdf>.

Neto, F. (2003). A new approach to sustainable tourism development: Moving beyond environmental protection. pp. 212-222. In: *Natural Resources Forum*. Retrieved from <http://www.un.org/esa/esa03dp29.pdf>

Olsen, S., Christie, P. (2000) *What Are We Learning from Tropical Coastal Management Experiences?*, pp. 5-18, Coastal Management. Retrieved <https://depts.washington.edu/smea/sites/default/files/patrickc/Olsen%20and%20Christie.Tropical%20ICM.2000.CMJ.pdf>

Peattie, K., & Peattie, S. (2009). Social marketing: a pathway to consumption reduction? pp. 260-268. In: *Journal of Business Research*. Retrieved from <http://www.sciencedirect.com/science/article/pii/S0148296308000489>

Peattie, S. (2007). The internet as a medium for communicating with teenagers. pp. 21-46. In: *Social Marketing Quarterly*. Retrieved from <http://smq.sagepub.com/content/13/2/21.short>

Protection Programs. (2011). *BVI Marine Guide*. Retrieved from <http://www.bvimarineguide.com/programs.html>

Puerto Rico House of Representatives. (1999). Law for the Protection, Conservation and Management of Puerto Rico Coral Reefs - (House of Representatives Bill 1466) – Law 147. Retrieved from http://www.darrp.noaa.gov/southeast/matthew/pdf/Law_147.pdf

Saphier, A. D., & Hoffmann, T. C. (2005). Forecasting models to quantify three anthropogenic stresses on coral reefs from marine recreation: Anchor damage, diver contact and copper emission from antifouling paint. pp. 590-598. In: *Marine pollution bulletin*. Retrieved from <http://www.sciencedirect.com/science/article/pii/S0025326X05001049>

Skipper Online Services. (2014). Canadian Safe Boating Course. Retrieved from <http://www.boaterexam.com/canada/education/c7-buoys-en.aspx>

Sly DF, Heald GR, Ray S. (2001). pp. 9-15 *The Florida 'Truth' anti-tobacco media evaluation: design, first year results, and implications for planning future state media evaluations*. Retrieved from <http://www.ncbi.nlm.nih.gov/pmc/articles/PMC1763974/>

Stephen R., Kellert, Jai N. Mehta, Syma A. Ebbin, Laly L. Lichtenfeld (2000). pp 705-715 *Community Natural Resource Management: Promise, Rhetoric, and Reality, Society & Natural Resources: An International Journal*. Retrieved from <http://www.tandfonline.com/doi/abs/10.1080/089419200750035575#.VJL0xyvF9c8>

Taylor Made Sur-Moor T3C Mooring Buoys. (2008). Retrieved from http://www.jamestowndistributors.com/userportal/show_product.do?pid=330#

The Ocean Portal Team. (2013). *Corals and Coral Reefs*. Retrieved from <http://ocean.si.edu/corals-and-coral-reefs>

The Ocean Portal Team (2013). *Seagrass and Seagrass Beds*. Retrieved from <http://ocean.si.edu/mangroves>

The Ocean Portal Team (2013). *Mangroves*. Retrieved from <http://ocean.si.edu/seagrass-and-seagrass-beds>

U.S. Cargo Control (2014). *Galvanized Eye & Eye Swivel - Carbon Steel - 7/8"*. Retrieved from <http://www.uscargocontrol.com/Rigging-Supplies-Hardware/Eye-Eye-Swivel-Galvanized-Carbon-Steel/Galvanized-Eye-Eye-Swivel-Carbon-Steel-7-8>

US Government of Interior, National Park Service. (2014). *Mooring Buoys*. Retrieved from <http://www.nps.gov/bisc/planyourvisit/mooring-buoys.htm>

USPS- United States Power Squadrons (2011). *Anchor Basics*. Retrieved from http://www.theensign.org/uspscompass/compassarchive/compassv5n11/v5n11_anchor.htm.

United States Navy, Naval Engineering Command. (1987). *Mooring Maintenance Manual, NAVFAC MO-124*, 34-41. US Navy.

Vlad, S. (2014). *Motorboat Runabout 8.7m*. GrabCAD. Retrieved from <http://grabcad.com/library/motorboat-runabout-8-7m-1>

Wilkinson, C. (2008). *Status of Coral Reefs of the World: 2008*. Townsville, Australia: Global Coral Reef Monitoring Network and Reef and Rainforest Research Centre. pp. 298. Retrieved from <http://www.vliz.be/imisdocs/publications/213229.pdf>

SolidWorks (2014). *3D CAD Packages*. Dassault Systems. Retrieved from <http://www.solidworks.com/sw/products/3d-cad/packages.htm>.

7.0 Appendices

Appendix A: Mooring buoy system and ecology survey in English

Qualtrics link: http://wpi.qualtrics.com/SE/?SID=SV_bdCQSnvvl8rDZpb

Introduction: “Hello, we are students from Worcester Polytechnic Institute, a university in Massachusetts. We are currently doing a study on boaters and their knowledge of the ocean ecosystem and mooring buoys. This survey is voluntary and anonymous. Names and emails will not be associated with answers. You do not have to answer every question. Thank you for your time.”

Please answer the following questions:

1: List marinas and cays where you most often boat.

2: What do you do when you're boating? Circle all that apply.

fishing recreational activities (i.e. waterskiing, wakeboarding, etc)
visiting the cays tourism transportation socialize
snorkel / scuba dive
other _____

3: How long have you been boating?

_____ years

4: How many days a week do you use your boat?

1-2 days

3-4 days

5-7 days

5: On a typical day, how long are you out on your boat?

_____ hours

6: What is the length of your boat?

< 16 feet 16 - 26 feet 27 - 40 feet 41 - 60 feet > 60 feet

7: When boating, do you ever raft (tie two or more boats together) onto other boats?

Yes

No

8: If yes; on average, how many boats?

_____ boats

The following questions are about marine ecosystem

9: Can you recognize coral reefs and seagrass beds when you are out on your boat?

- a. Yes
- b. No
- c. I don't know

10: How common are coral reefs and seagrass around the island?

- a. Do not exist
- b. Very uncommon
- c. Somewhat common
- d. Very common
- e. I don't know

11: How important is the presence of coral reefs in the marine ecosystem?

- a. Very important
- b. Somewhat important
- c. Not important
- d. I don't know

12: What are the major roles of coral reefs? (check all that apply)

- Provide shelter for various marine life
- Regulate salt levels in the ocean
- Protects the coast from storm waves and swells
- Regulate carbon dioxide levels in the ocean
- Prevent harmful animals (sharks, jellyfish, etc.) from reaching shallow waters
- Support the economy through tourism
- I don't know

13: To what level do you think the coral reefs are at risk of local extinction (when all coral reefs in Puerto Rico die out)?

- a. Nearly extinct
- b. High risk of extinction
- c. Medium risk of extinction
- d. Low risk of extinction
- e. No risk of extinction
- f. I don't know

14: Does boat anchoring put marine life in danger?

- a. Yes, in great danger
- b. Yes, a little danger
- c. No, not in any danger
- d. I don't know

15: Do you know what mooring buoys are and why they are used?

- a. I have never heard of them
- b. I don't know what they are, but I have heard of them
- c. I think I know what they are, but am not sure what they are used for
- d. I know what they are, and I know what they are used for

16: How many mooring buoys are there around the cays?

- a. 0 -100
- b. 101-200
- c. 201-300
- d. 300+
- e. I don't know



The picture shows a DRNA mooring buoy located around Puerto Rico
 Referring to the picture above, please mark the boxes with an X that are associated with
 your level of agreement on the following statements

	Strongly Disagree (1)	Disagree (2)	Neither Agree nor Disagree (3)	Agree (4)	Strongly Agree (5)
I have seen mooring buoys located around the cays.					
I am comfortable with latching my boat onto the mooring buoy.					
I use anchors instead of the mooring buoys.					
I use the mooring buoys frequently.					
I use the mooring buoys and tie together (raft) with other boats.					
When I use the mooring buoys, I also drop anchor.					

18: If you said “Agree” or “Strongly Agree” to the last statement, briefly describe why:

Please answer the following questions about demographics.

19: Age? (years) under 18 18 - 25 26 - 35 36 - 50 above 50

20: Gender? Male Female

21: Occupation? _____

Thank you for taking this survey! We are currently in the process of designing a rafting mooring buoy. Once we have this created, we would love to hear your feedback about the design. If you would like, please leave your contact information below and we will contact you once the design is ready. Thank you!

Name: _____

Phone: _____

E-mail: _____

What is your preferred method of contact? We remind you that this information is confidential and your information will not be utilized, seen nor shared with anyone else.

Text

Phone

Email

No preference

Appendix B: Estudio de boyas de amarres y sistemas marinos

Qualtrics link: http://wpi.qualtrics.com/SE/?SID=SV_a5b7a7MQapYJw0d

Introducción: “Buenos días, somos estudiantes de Worcester Polytechnic Institute, una universidad en Massachusetts. Estamos haciendo un estudio con navegantes de su conocimiento de los ecosistemas marinos y los sistemas de boyas de amarre. Este sondeo es voluntario y anónimo. Nombres y correos electrónicos no serían asociados con las respuestas. Usted no necesita contestar cada pregunta. Gracias por su tiempo.”

Por favor conteste las siguientes preguntas:

1: Mencione las marinas y los cayos que más visita en su embarcación.

2: ¿Qué hace cuando va a navegar? Escoge todos que apliquen.

pescar actividades recreativas (esquiar, etc.) hacer snorkel/bucear con tanque
socializar transporte turismo visitar los cayos
otro: _____

3: ¿Qué tiempo lleva negando?

_____ años

4: ¿Cuántos días a la semana usa su embarcación?

1-2 días 3-4 días 5-7 días

5: ¿En un día típico, cuánto tiempo está fuera en su embarcación?

_____ horas

6: ¿Cuál es el largo (eslora) de su embarcación?

< 16 pies 16 - 26 pies 26 - 40 pies 40 - 65 pies > 60 pies

7: ¿Se amarra usted a otras embarcaciones?

No Sí

8: Si su respuesta es afirmativa, ¿cuántas embarcaciones se amarran entre sí?

_____ embarcaciones

Las siguientes preguntas son sobre los ecosistemas marinos. Por favor conteste las siguientes preguntas.

9: ¿Puede reconocer los arrecifes de coral y las praderas de yerbas marinas cuando va a los lugares que visita?

- a. Sí
- b. No
- c. No sé

10: ¿Cree usted que los arrecifes de coral y las praderas de yerbas marinas son comunes en la isla?

- a. No existe
- b. Muy raro
- c. Un poco común
- d. Muy común
- e. No sé

11: ¿Cuán importante es la presencia de arrecifes de corales en los ecosistemas marinos?

- a. Muy importante
- b. Un poco importante
- c. No es importante
- d. No sé

12: ¿Cuáles son las funciones principales de los arrecifes de corales? (marcar todas las que corresponden)

- Proveer refugio para diversos organismos marinos
- Regular los niveles de sal en el océano
- Proteger la costa de oleaje y marejada tormentosa
- Regular los niveles de dióxido de carbono (CO₂) en el océano
- Evitar que animales peligrosos (tiburones, aguavivas, etc.) lleguen a la costa
- Respalda la economía por el turismo
- No sé

13: ¿A qué nivel cree usted que los arrecifes de coral están a riesgo de extinción local (todos los arrecifes de coral mueren en Puerto Rico)?

- a. Cerca de extinción local
- b. Riesgo alto de extinción local
- c. Riesgo mediano de extinción local
- d. Riesgo bajo de extinción local
- e. No hay un riesgo de extinción local
- f. No sé

14: ¿El anclar embarcaciones pone la vida marina en peligro?

- a. Sí, en mucho peligro
- b. Sí, en un poco peligro
- c. No, no es en peligro
- d. No sé

15: ¿Sabe qué son los sistemas de boyas de amarre y por qué se usan?

- a. Nunca he escuchado sobre ellos
- b. No sé que son, pero he escuchado sobre ellos
- c. Creo saber lo que son, pero no estoy seguro por qué se usan
- d. Sé lo que son y por qué se usan

16: ¿Cuántas boyas de amarre tenemos en todo Puerto Rico?

- a. 0 - 100
- b. 101 - 200
- c. 201 - 300
- d. 300 +
- e. No sé



Esta foto muestra una boya de amarre instalada por el DRNA.

Utilizando la foto de arriba, por favor conteste las siguientes preguntas. Por favor marque 'X' en el espacio provisto que corresponda con la respuesta que usted mejor entienda.

	Muy en Desacuerdo (1)	En Desacuerdo (2)	No Estoy De Acuerdo Ni en Desacuerdo (3)	De Acuerdo (4)	Muy De Acuerdo (5)
He visto las boyas de amarre en los cayos.					
Me siento confiado amarrando mi embarcación a la boya de amarre.					
Uso el ancla en vez de utilizar la boya de amarre.					
Uso las boyas de amarre con frecuencia.					
Uso las boyas de amarre y también amarro mi bote a otras embarcaciones.					
Cuando uso las boyas de amarre, también tiro el ancla.					

18: Si marca 'X' en 'De Acuerdo' o 'Muy De Acuerdo' para la última aseveración, escriba por qué:

Por favor conteste las siguientes preguntas de demográficas.

19: ¿Edad? menos de 18 18 - 25 26-35 36-50 más de 50

20: ¿Género? Hombre Mujer

21: ¿Ocupación? _____

Gracias por su tiempo. Nuestro equipo está trabajando en un diseño de un sistema de boyas de amarre donde las embarcaciones pueden amarrarse al sistema y entre sí. Cuando finalicemos el diseño, nos gustaría tener su opinión. Por favor provéanos su información de contacto para mostrarle el diseño cuando esté listo. ¡Gracias!

Nombre: _____

Número de teléfono o celular: _____

Correo electrónico: _____

¿Cómo prefiere que nos comuniquemos? Le acordamos que esta información es confidencial y que su información personal no sería utilizada, vista, ni compartida con terceros.

Text Llama Correo electrónico

No tengo una preferencia

Appendix C: Email to the *La Regata* newspaper subscribers

The following appendix contains the email that was sent to the subscribers of the *La Regata* newspaper.

Dear subscribers,

Hello, we are students from Worcester Polytechnic Institute, a university in Massachusetts. We are currently working with the DRNA to create a rafting mooring buoy to be implemented around Puerto Rico. We have made a survey for the boating community about marine ecosystems and boat-securing devices, and it would be greatly appreciated if you could complete it. Results from the survey will be helpful in the design of the rafting mooring buoy, and how to promote it. This survey is voluntary and anonymous. Names and emails will not be associated with answers, and personal information will not be disclosed to any third parties. It is not necessary that every question is answered. Thank you for your time. If you have any questions or concerns about the survey or our project in general, please feel free to email us at pr14boats@wpi.edu <<mailto:pr14boats@wpi.edu>>.

Para Español http://wpi.qualtrics.com/SE/?SID=SV_a5b7a7MQapYJw0d

In English http://wpi.qualtrics.com/SE/?SID=SV_bdCQSnvvl8rDZpb

We also have the introduction in Spanish as well for your convenience:

Hola, somos estudiantes del Instituto Politécnico de Worcester (WPI por sus cifras en inglés), una universidad en Massachusetts. Actualmente estamos trabajando con el DRNA para crear un sistema de amarre de balsa para ser implementada por todo Puerto Rico. Hemos hecho una encuesta para la comunidad de navegación sobre los ecosistemas marinos y los dispositivos al usar cuando se desembarque la embarcación; estaremos muy agradecido si usted podría completarlo. Los resultados de la encuesta serán útiles en el diseño de la boya de amarre en balsa, y ayudará en promoverla. Esta encuesta es voluntaria y anónima. Los nombres y correos electrónicos no estarán asociados a las respuestas, y la información personal no serán cedidos a ninguna persona ni grupo. No es necesario que todas las preguntas se contesten. Gracias por su

tiempo. Si usted tiene alguna pregunta o inquietud acerca de la encuesta o de nuestro proyecto, en general, siéntase a libertad en enviarnos un correo electrónico a pr14boats@wpi.edu.

Para Español http://wpi.qualtrics.com/SE/?SID=SV_a5b7a7MQapYJw0d

In English http://wpi.qualtrics.com/SE/?SID=SV_bdCQSnvvl8rDZpb

Once again, thank you for helping us out. Let us know if you have any questions or concerns, feel free to email us at pr14boats@wpi.edu

Sincerely,

WPI Marine Team (Boats)

Kelsey

Kaitlin

Sarah

Abdullah

Appendix D: Raw data for Survey #1

The following tables contain the raw data obtained from the first survey. This data in particular corresponds with surveys that were handed out in person. The total number of surveys handed out was 97.

1. List marinas and cays where you most often boat.

Text Response
Puerto del Rey, Puerto Chico, Palominos, Icacos, piñero, luis peña, ramos, Culebra, Vieques
Palomino, Icacos, Dakiti & las Pelas (culebra), Piñero, punta Arena (vieques). Basically, east of PR and Culebra
Parguera
Puerto del Rey, Ponce Yacht and Fishing Club, Vieques, Culebra, Palomino, Caja de Muertos, La Parguera
I took a refresher course in sailing in Fajardo. I am making a sailboat, a Glen-L 15' and plan to sail it in Fajardo.
Icacos, Polomino, Palominito, Lobo, Cayo Diablo, Pinero, Medio Mundo, Culebra, Culebrita, Vieques, Esperansa...
Marina Puerto Chico, Icacos, Palominos, Palominito, Piñero
Club Nautico Boqueron, Cabo Rojo, PR
Las Pelas, Culebra Culebrita
Puerto del Rey Marina
Ponce Yacht & Fishing Club, Club Náutico de la Parguera & Marina Pescadería Caja de Muertos, San Jacinto & La Parguera

Salinas, PR
Marina Puerto del Rey PR eastern end islands Culebra V.I.
Marina Puerto del Rey, Cangrejos Yacht Club, Ponce Yacht & Fishing Club, Marina Pescadería
Culebra Culebrita Vieques BVI
Icacos, palomino, matias, isla de barco, cayo piñero
Enrique, Cardona. Caja ee Muertos
Villa Marina, Puerto del Rey, Las Croabas, Club Nautico de Ponce, Humacao Yatch Club, Marina Pescaderia, Palomino, Icacos, Culebra, Culebrita, Cayo Caracoles, Cayo Enrique, Caja de Muerto.
Puerto chico , punta arena , icacos y culebra
Parguera, Caracoles, Enrique, Playa Buye
Cabuzazos, Caja de Muertos, Salinas
Icacos, palomino, medio mundo, culebra
icacos, palomino, culebra
Cayos en la costa de Fajardo, Salinas y en Rio Grade
Cayos de Salinas, Guayama y Fajardo
Sunbay Marina, Icacos, Culebra, Pinero
Caracolees. Caja. Mueros. Mona. Culebra
Vega Baja, Fajardo, Culebra, Cabo Rojo

Bahia Jauca Santa Isabel, Cayo Matias Salinas, Punta Balaju Santa Isabel
Cayo Enrique. Combate, Los Pozos, Buye, Crash Boat
Sun bay marina, pinero, icacos y culebra
Club Nautico de Guayama, los cayos que visito estan unicados en la Bahia de Jobos.
Area este Fajardo Icacos, Palomino, Palominito
Culebra y vecindad, y los cayos de la Pargur
Fajardo = Palominos, Icaico, Isla de Ramos, Lobos, Piñero, Vieques y Culebra
Icacos, Palominos, Isla Pinero, Medio Mundo, Salinas del Norte (Cayo Yayis), La Chiva en Vieques, Punta Arenas en Vieques
Marina Puerto Chico Palomino, Palominito, Icaico
Cayo Caracoles
Parguera,Boquerón,Combate
Sea Lover Marina, Icacos, Palominos y Palominitos
La Parguera - Cayo Enrique
RINCON ,PARGUERA LAJAS,
Marina Puerto Del Rey; Palomino, Icacos, Luis Peña, Piñerito, Vieques (punta del Este, y otros), Culebra y Culebrita
Palmas del Mar, Esperanza, bahía Chivas Vieques
Palomino ,Icacos, Punta Arenas, Combate, Dakiti

puerto del rey cap cana marina la romana
Cayos en Parguera, Ponce y otros
Marina Puerto del Rey, Fajardo. Cayos: Icacos, Palominito, Pinero, Palomino, Culebra y Vieques.
La Parguera-Lajas,P.R.
Islas de Puerto Rico, Vieques, Culebra, USVI y BVI
FAJARDO, SALINAS,CULEBRA,PONCE
Isleta Marina y Los capos: Icacos, Palomino,Culebra y Vieques
Marina Puerto del Rey, Cangrejos Yacht Club, Ponce Yacht & Fishing Club, Marina Pescadería
Culebra Culebrita Vieques BVI
Icacos, palomino, matias, isla de barco, cayo piñero
Enrique, Cardona. Caja ee Muertos
Villa Marina, Puerto del Rey, Las Croabas, Club Nautico de Ponce, Humacao Yatch Club, Marina Pescaderia, Palomino, Icacos, Culebra, Culebrita, Cayo Caracoles, Cayo Enrique, Caja de Muerto.
Puerto chico , punta arena , icacos y culebra
Parguera, Caracoles, Enrique, Playa Buye
Nautico San Juan, San Juan Bay, Cap Cana Marina, Villa Marina
Nautico de San Juan, Saint Thomas, Culebra

Puerto del Rey, Yacht Haven
Palomina, Culebras, St. Thomas, Marina Puerto del Rey
Palominos, Culebra y Culebrita, Stamos
Villa Marina, Puerto del Rey, Culebra, Palomino
Dakity. Las Pela, Culebrita
Marinas: Puerto Chico, Fajardo Cayos: Luis Pena, Culebrita, Palomina
Sun bay Marina, Bilter End, Norman Island, Yacht Heaven Grande, Culebra, Maho bay, Cane Garden, Jost van dyke
Culebra PR, St Thomas St Johns USVI, Virgin Fiona BVI
Culebra (PR), Saint John's, BVI, Saint Thomas
Puerto del Rey, Crown Bay Marina, Cayo Luis Pena, Culebrita, Vieques
Sunbay Marina, Las Pelas, Culebrita
Sunbay Marina, Las Pelas, Kew
Puerto del Rey, Cayo Luis Pena, Culebrita, Medio Mundo, Palomino, Icaco
Puerto del Rey, Cayo Luis Pena, Culebrita, Medio Mundo, Palomino, Icaco
Puerto del Rey, Cayo Luis Pena, Culebrita, Medio Mundo, Palomino, Icaco
Palomino, Icaco, Culebra (Luis Pena, Tamarindo), Dakiti, Culebrita, Virgin Islands
Puerto del Rey Marina Cayo: Palomino, Palominito

Marina Puerto del Rey, Culebra, Palomino, Vieques, Icacos, US Virgin islands
Culebrita, Luis Pena, Pelas, . . . Crown Bay
RINCON ,PARGUERA LAJAS,
Marina Puerto Del Rey; Palomino, Icacos, Luis Peña, Piñerito, Vieques (punta del Este, y otros), Culebra y Culebrita
Palmas del Mar, Esperanza, bahía Chivas Vieques
Palomino ,Icacos, Punta Arenas, Combate, Dakiti
puerto del rey cap cana marina la romana
Cayos en Parguera, Ponce y otros
Marina Puerto del Rey, Fajardo. Cayos: Icacos, Palominito, Pinero, Palomino, Culebra y Vieques.
La Parguera-Lajas,P.R.
Islas de Puerto Rico, Vieques, Culebra, USVI y BVI
FAJARDO, SALINAS,CULEBRA,PONCE
Isleta Marina y Los capos: Icacos, Palomino,Culebra y Vieques
Icacos, Isla Piñeros, Culebra

Common activities boaters engage in were measured in Question 2. The options given were fishing, recreational activities, snorkeling/scuba diving, socializing, tourism, transportation, and visiting the cays. A write-in, “other”, option was also available. The data gathered from the online and in-person surveys was grouped together for this question, because initial examination

of the data indicated minimal differences between the two groups. From the graph in Figure 56, it is clear that “socializing” was the most commonly chosen answer.

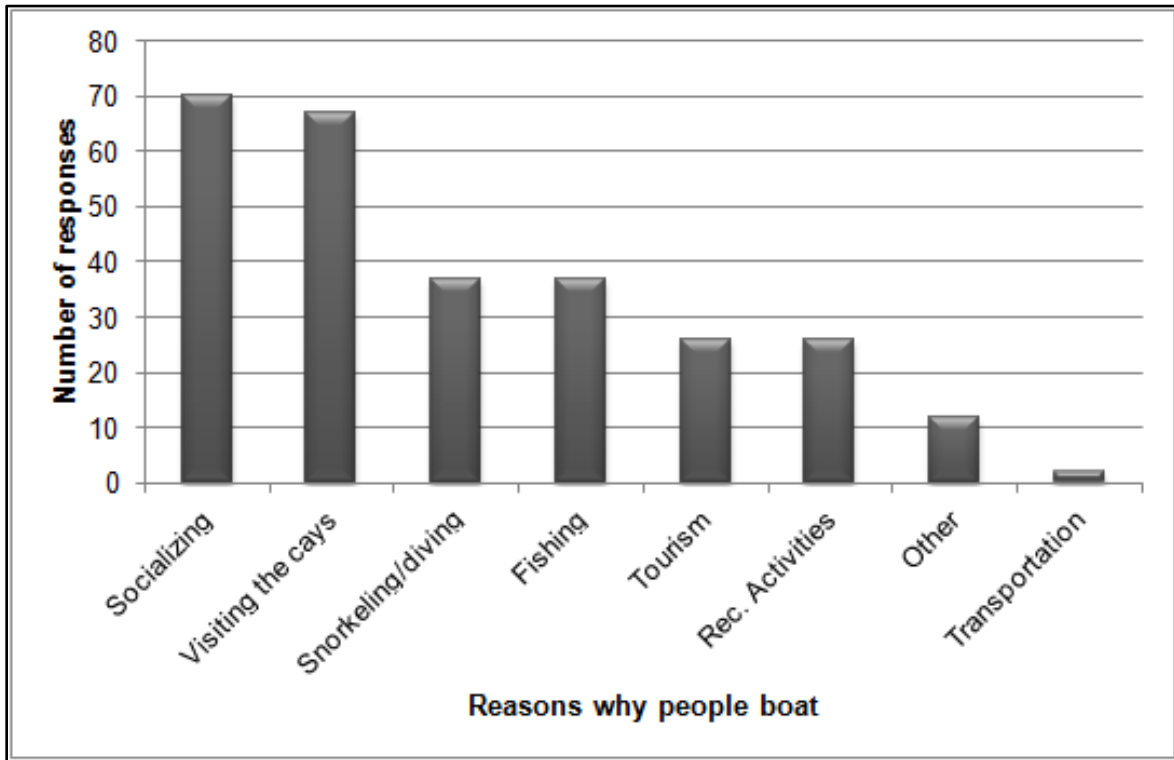

Figure 56: The results to “What do you do when you’re boating?”; n=93; respondents had the option to give multiple answers.

Question 3 asked the number of years the respondent had been boating. We used this to determine if boating experience had an effect on knowledge of marine life. Results from this question can be seen in Figure 57.

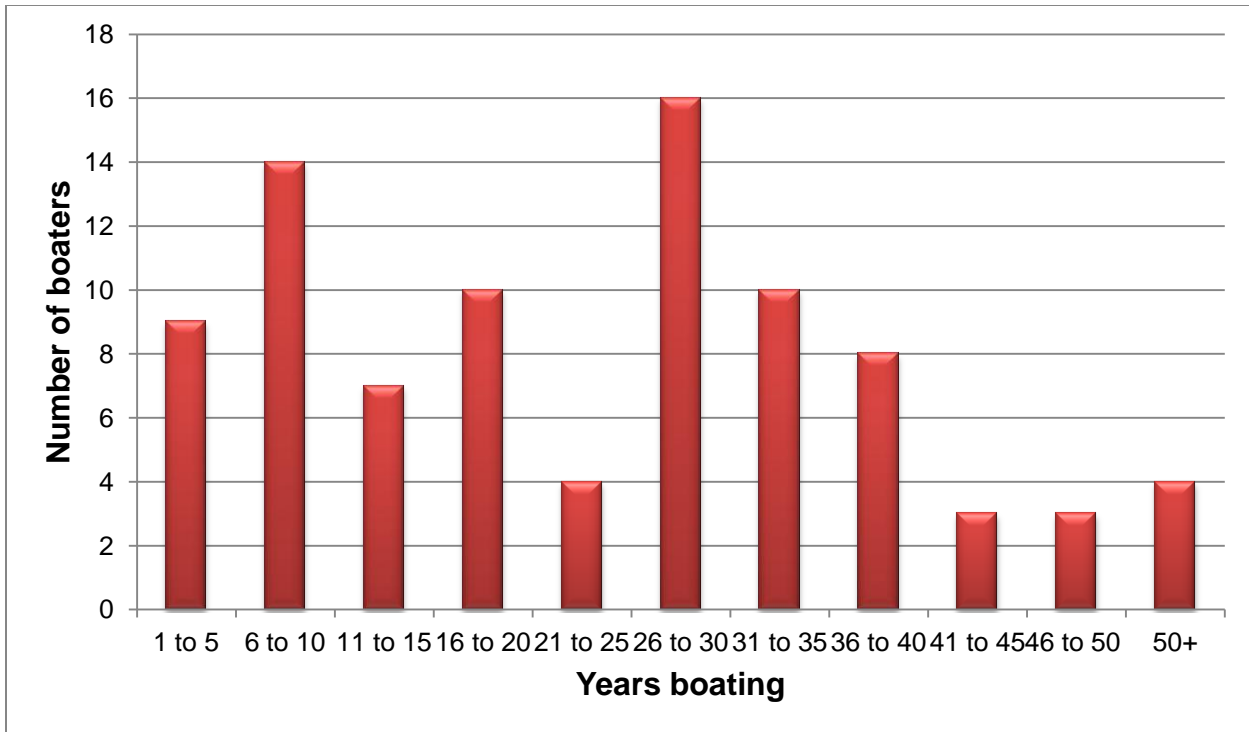

Figure 57: A graph showing the results to “How long have you been boating?”; n= 89

Question 4 and 5 asked about the number of the days per week the boaters took their boats out in the water, and how much time they spend boating. Figure 58 shows a histogram of the results.

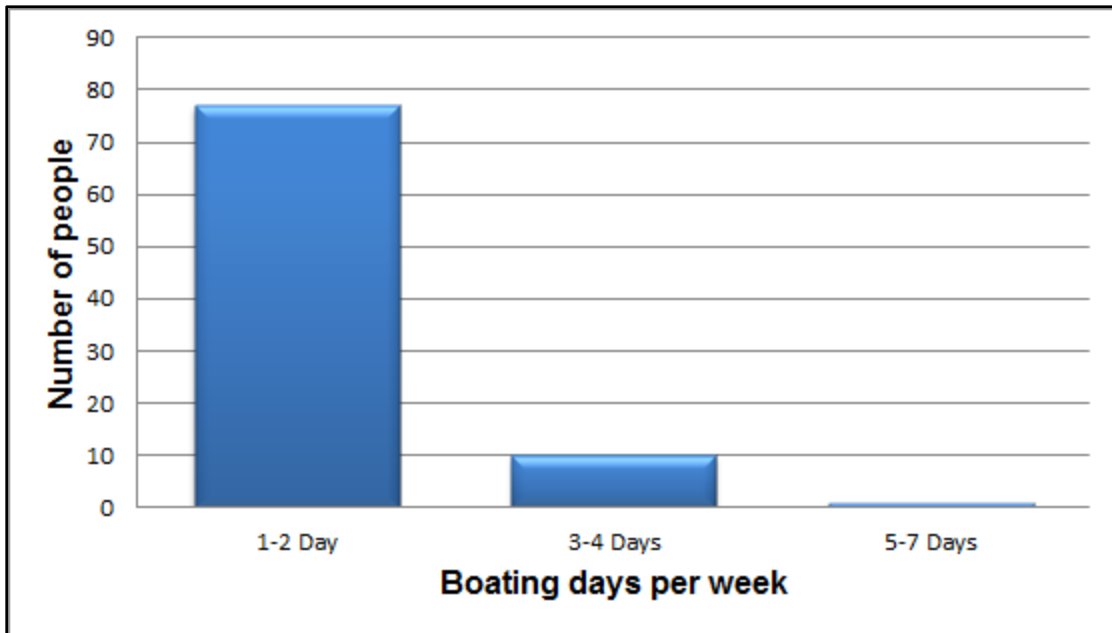

Figure 58: A histogram of the results for “How many days a week do you use your boat?”; n=88

Question 4 was useful in obtaining the frequency and the percentages for the number of days per week the surveyed people use their boats. From the results we saw that out of 88 respondents, 77 respondents chose the first answer, 10 boaters chose the second option, and only 1 respondent chose the third answer. Figure 59 shows a pie chart of these results.

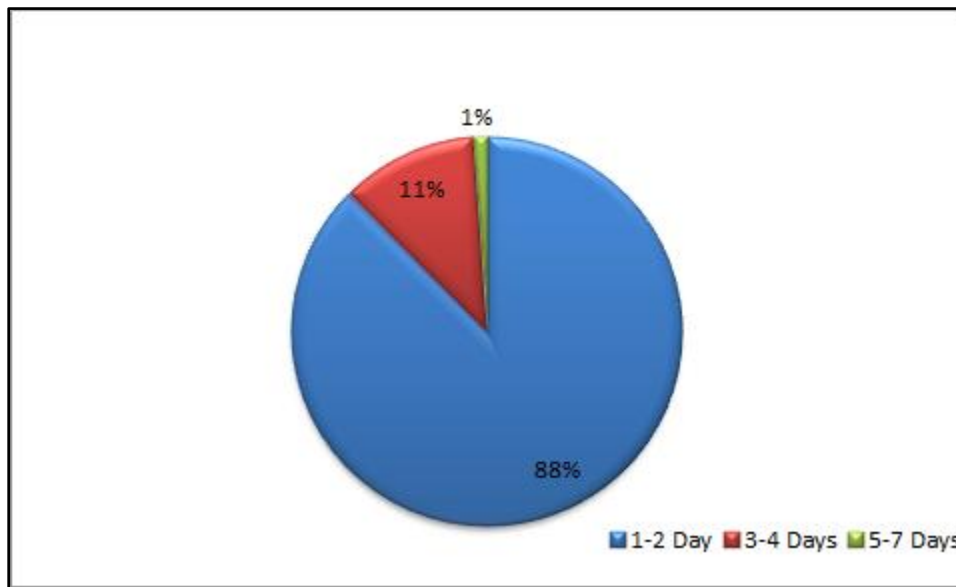

Figure 59: A pie chart of the results for “How many days a week do you use your boat?”; n=88

The highest percentage of sample size boaters is 88% who boat 1 or 2 days in a given week, whereas 11% of the sample size boat 3 to 4 days a week, and only 1% of the sample size boat 5 to 7 days a week.

Question 5 asked about the total duration, in hours, of each boating session. There was only a write-in option available for this question. Through the responses we were able to achieve a further understanding of time people spend boating. Figure 60 shows a bar graph representing number of boaters and the hours they spent boating.

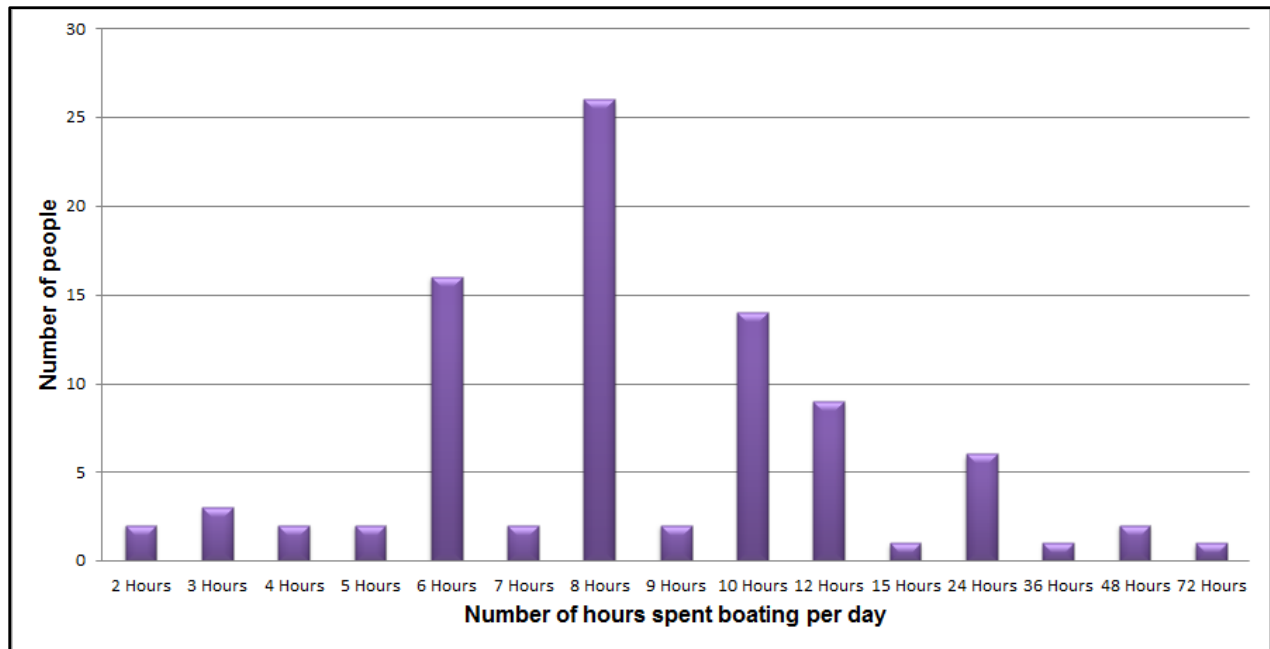

Figure 60: The results “On a typical day, how long are you out on your boat?”; n=89

We saw a large variation in the frequency of boaters for the different amounts of time they spend boating. The total number of respondents for this question was 89 and the data was pooled together. The highest frequency of the boaters was 26 and it corresponded to 8 hours of boating. That means 26 people out of our sample size boat for 8 hours. The lowest frequency was 1 which corresponded to 15 hours, 36 hours, and 72 hours. 3 people only boat for 3 hours per week. Further, we saw that the frequency of people who boat for 24 hours was 6, and the frequency of people who boat for 6 hours was 16.

Through further analysis, we saw the different percentages of the number of people and the time in hours they spend boating. The highest percentage, 29%, represents people who boat for 8 hours at a time. The number of people who boat for 6 hours is 18%, for 10 hours is 16%, for 12 hours is 10%, and for 24 hours is 7%. The lowest percentage is 1% represents the boaters who boat for 72 hours, 36 hours, and 15 hours. Furthermore, only 2% people boat for 2 hours, 4 hours, 5 hours, 7 hours, 9 hours and 48 hours respectively.

We learned from Question 5 that on an average a boater will approximately spend: Mean = $(895 \text{ hours} / 89 \text{ boaters}) = 10.95$ hours per a boating session. We saw that the modal frequency (most occurring frequency) is 26, which corresponds to 8 hours of boating. From Question 4 we also found out that highest percentage of boaters is 88%. This gave us an idea of how many boats we can hope to find around the waters surrounding Puerto Rico. The sample size was not big

enough to determine how many boats we will find at a given day, so if we assume that only 5% of the active boaters go boating at any given week it will still translate into 1500 boats of the 30,000 registered boats (A. Velazco, personal communication, 2014). If 88% of these people go for boating once a week, this will still give us 1320 boats. This shows that the number of registered boats clearly outnumber the 300 moorings around Puerto Rico.

Question 6 asked boaters about the length of their boats. They had the options of less than 16 feet, 16-26 feet, 27-40 feet, 41-60 feet and greater than 60 feet. This was asked to figure out the most common range of boat lengths that would subsequently be used in our stress calculations for the final designs. The following figure (Figure 61) shows a bar graph that shows these responses.

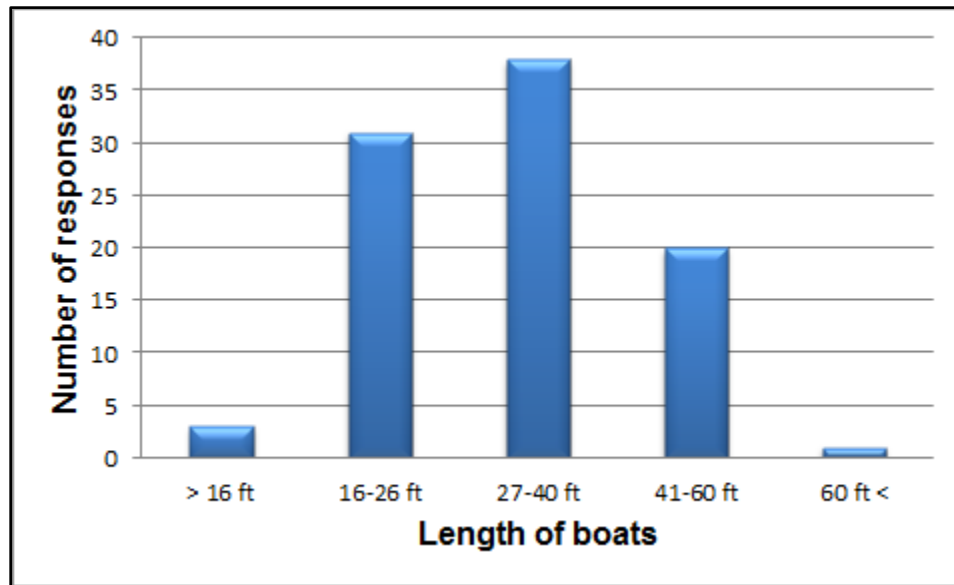

Figure 61: The figure that shows the results of “What is the length of your boat?”; n = 93

The total respondents to these questions were 93. With the results obtained, the highest frequency of the boaters was 38 for the range of 27 – 40 feet. The lowest frequency of the boaters was 1 for the boat length range greater than 60 feet. 3 for people with a boat length range of less than 16 feet, 31 for the boat length range of 16 – 26 feet, and 20 for the boat length range of 41-60 feet. Further analysis showed that owners of 27-40 foot boats were 40.9% of the total survey sample, highest percentage response, for this question. The lowest percentage of responses was 1.1% for the response for the boats greater than 60 feet. For response of 41-60 feet for boats the response was 21.5%, for 16-26 the response was 33.3%, and for the boats below 16 feet the

response was 3.2% as a percentage of the survey sample. This helped us in optimizing the design which focused more on boats with a length under 40 feet, as they represent 77.4% of the total boaters we surveyed.

Question 7 and 8 specifically related with the practice of rafting. Question 7 asked if the boaters practiced rafting. This was a yes or no question. It was asked to know how many people engaged in rafting so that we could analyze the feasibility of our design. Figure 62 shows the bar graph with the responses.

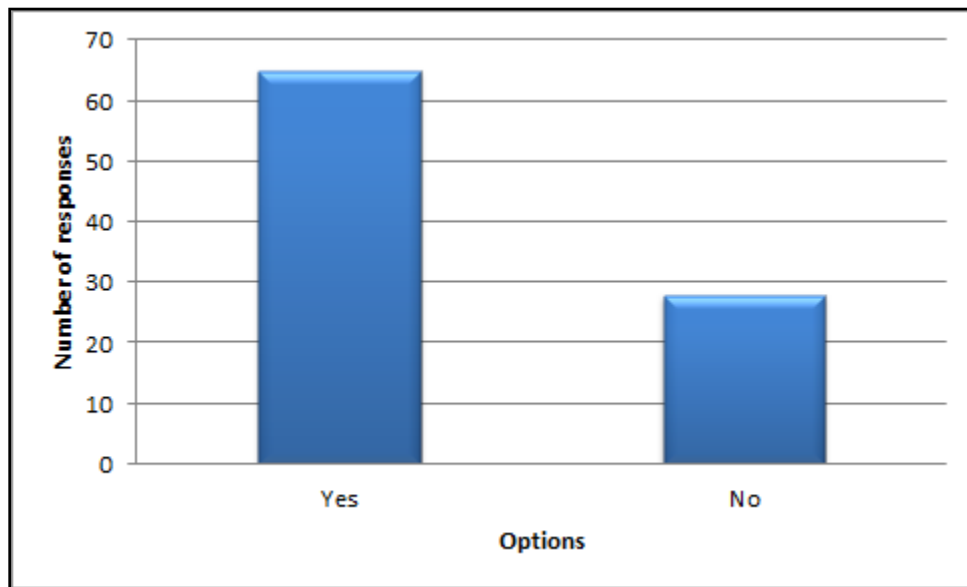

Figure 62: The responses to the question “When boating, do you raft (tie two or more boats together) onto other boats?, n = 93

Question 8 asked about the number of boats other people usually raft with. This was a write-in question so we had a wide range of answers in form of integers as well as ranges. This was asked to determine the optimum number of line attachments in our system. However the results ranged from 2 to 10. We broke down the responses in two separate groups: integer responses and range responses. We had a total of 58 responses to this question after omitting 3 results that lacked sufficient data. The following figure (Figure 63) shows the graphs of the responses obtained in the form of integers.

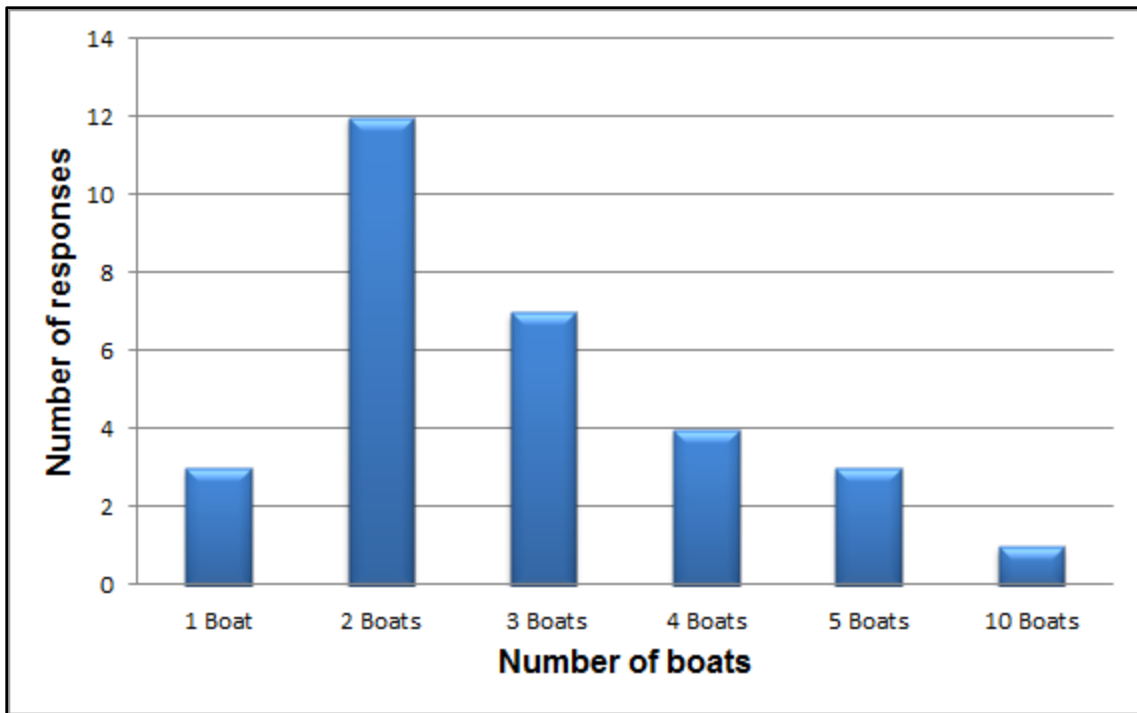

Figure 63: Results in a bar graph for the “If yes; on average, how many boats?” in integers, n = 30

The total number of people who responded in integers was 30 or 51.7% of the total responses. The results of this question show that the highest frequency of the responses was 12 for people who raft with 2 other boats while the lowest frequency was 1 that corresponded to 10 other boats. Other frequencies were 3 corresponding to 1 other boat, 7 corresponding to 3 other boats, 4 corresponding to 4 other boats, and 3 corresponding to 5 other boats. Further analysis showed that the highest percentage of respondents was 40%, which corresponded to those who raft with 2 other boats. The lowest percentage was 0.03% which corresponded to those who raft with 10 other boats. Respondents who raft with 1 other boat represented 10% of the data, respondents who raft with 3 other boats represented 23.3% of the total data, respondents who raft with 4 other boats represented 13.3% of the total data, and respondents who raft with 5 other boats also represented 10% of the total data. Figure 64 shows the number of boats that boaters raft with, in ranges.

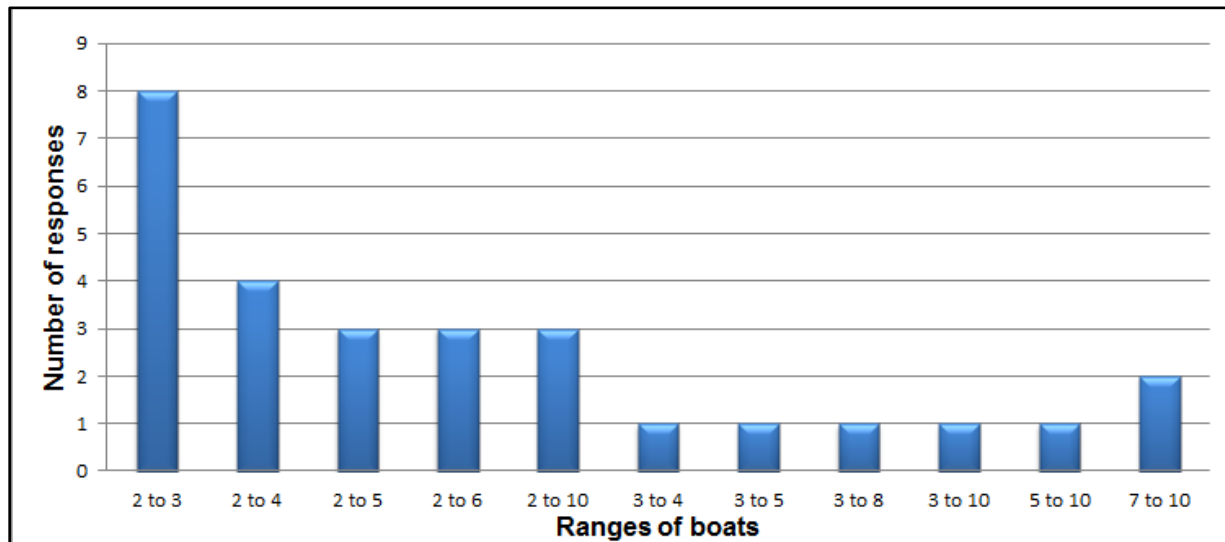

Figure 64: Results in a column bar graph for the “If yes; on average, how many boats?” in ranges, n = 30

Figure 64 shows the second breakdown of the responses that were given in ranges. The total responses were 28 or 48.3% of the total responses to this question. Through our results we saw that the most common frequency was 8 for 2 to 3 boats. There were five least common responses: 3 to 4 boats, 3 to 5 boats, 3 to 8 boats, 3 to 10 boats, 5 to 10 boats, and 7 to 10 boats whose frequency was 1. Other responses were 2 to 5 boats, 2 to 6 boats, 2 to 10 boats, which all had a frequency of 3. The response 2 to 4 boats had a frequency of 4. Further statistical analysis showed that 25.6% people rafted with 2 to 3 other boats which was the highest percentage of responses given in ranges. The lowest percentage was 3.6% for the people who raft with 3 to 4, 3 to 8, 3 to 8, 3 to 10 and 5 to 10 boats. People who raft with 2 to 4 other boats represented 13% of the total respondents who answered with a range of boats.

We also analyzed results for questions that relate to marine ecosystems, and how various boat-securing devices affect these ecosystems. To do this, we compared answers to questions 9 through 15. Question 9 asked about the respondent’s ability to recognize important marine ecosystems. If boaters were not able to recognize these ecosystems when they were visible, then boaters would not know when they drop their anchors on them. 88 out of 91 respondents said that they were able to recognize coral reefs and seagrass. Figure 65 shows all of the results for question 9.

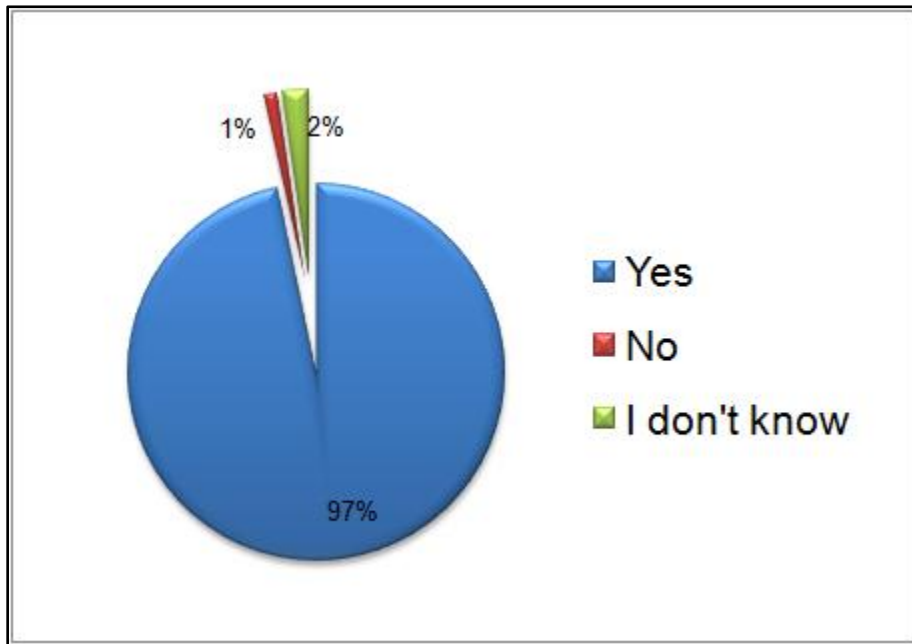

Figure 65: The results that represent the respondents' ability to recognize coral reefs and seagrass, n = 91

Question 10 asked about the frequency of important marine ecosystems around Puerto Rico. If people do not think that they are common, then it is possible that they will not see the importance of using the mooring buoys, and will continue to drop their anchors. 96% of survey respondents said that coral reefs and seagrass were somewhat common or very common around Puerto Rico, with 83% of respondents saying that very common and 13% of respondents saying somewhat common. Figure 66 contains the results for Question 10.

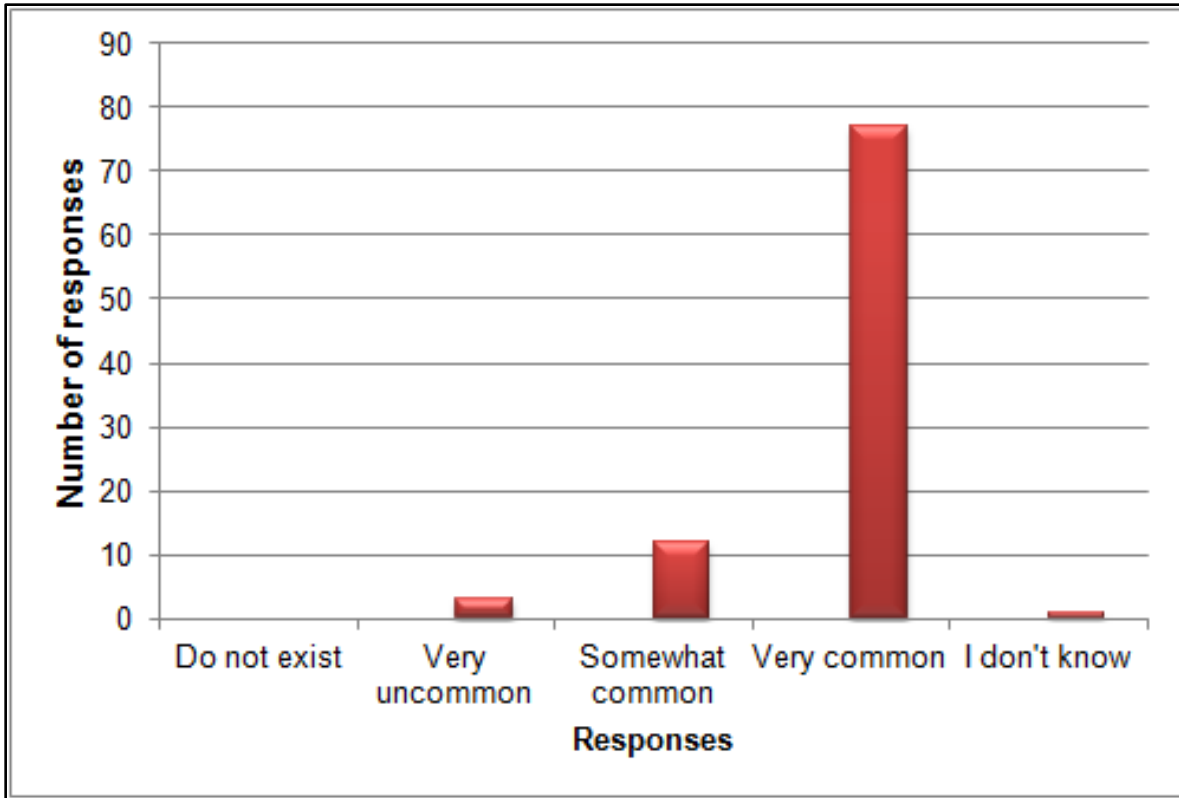

Figure 66: The results of the question that asks about the commonality of marine ecosystems, n=93

Questions 11 and 12 related to the importance of coral reefs and their functions. 99% of the respondents thought coral reef ecosystems were very important, while 1% of respondents thought coral reefs and seagrass were somewhat important. Figure 67 shows a pie chart, representing the results for Question 11 that relates to the importance of coral reefs.

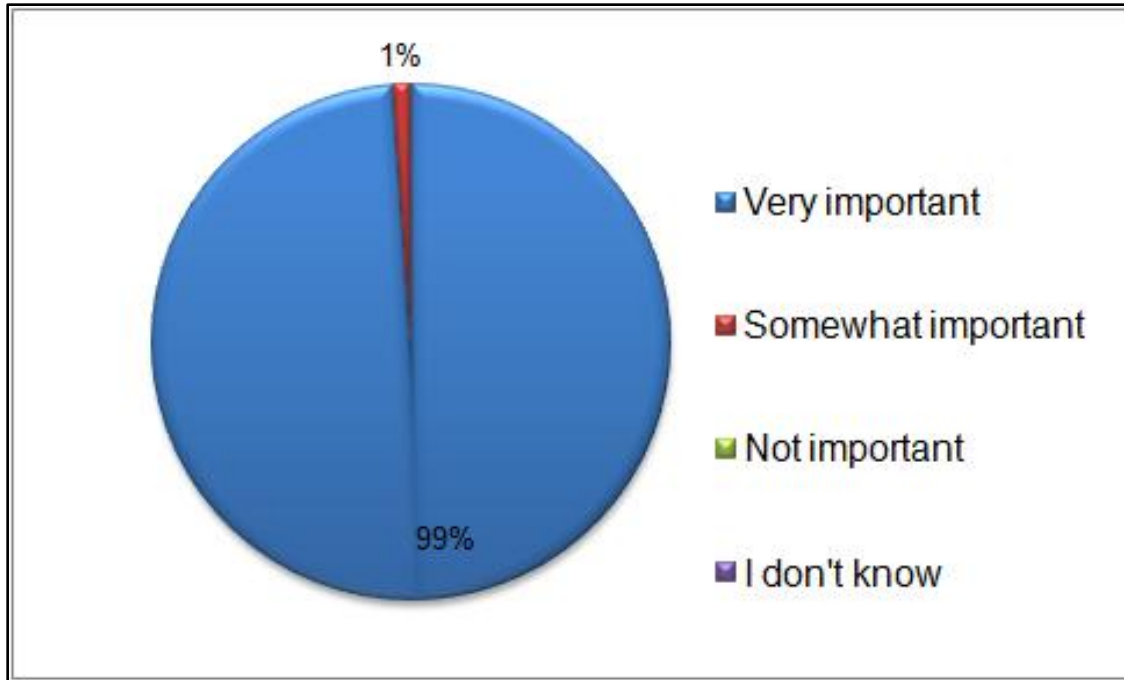

Figure 67: The results for the question that pertains to the importance of coral reefs in the marine ecosystem, n=93

Question 12 asked about the major roles of coral reefs. This question asked respondents to check off all functions that apply to coral reefs. 91 respondents chose the first option, 77 chose the third option, 35 chose the fourth option, and 35 chose the sixth option. All of those options mentioned above were correct answers. 19 survey respondents chose the second option, and 10 chose the fifth option. The second and fifth options were both incorrect answers. The total number of respondents is unknown because respondents could select multiple answers for this question, and respondents were not required to answer every question if they did not want to. However, the average number of respondents for each question is about 93. Figure 68 shows the results for Question 12.

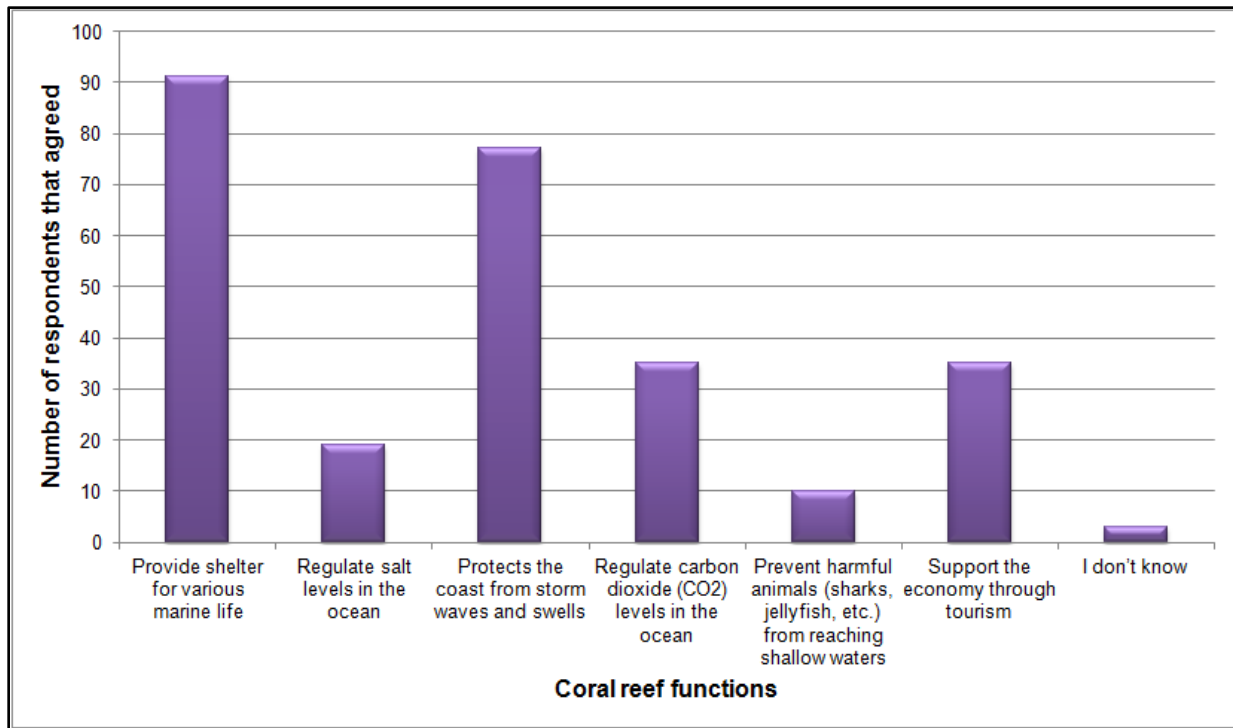

Figure 68: The results for the survey question pertaining to coral reef function, n is approximately 93

The results from Questions 11 and 12 showed that most boaters know the importance of coral reefs and seagrass, but they do not necessarily know about their specific roles in the ocean ecosystem.

Question 13 asked about the population trends of coral reefs in Puerto Rico. These trends are based on the rate of local extinction specifically in Puerto Rico. 2% of survey respondents believed that coral reefs are locally near extinction, 52% of survey respondents believed that coral reefs are at a high risk of local extinction, and 38% believed that they are at a medium risk of local extinction. Figure 69 shows the results for this question by giving the total number of responses for each answer.

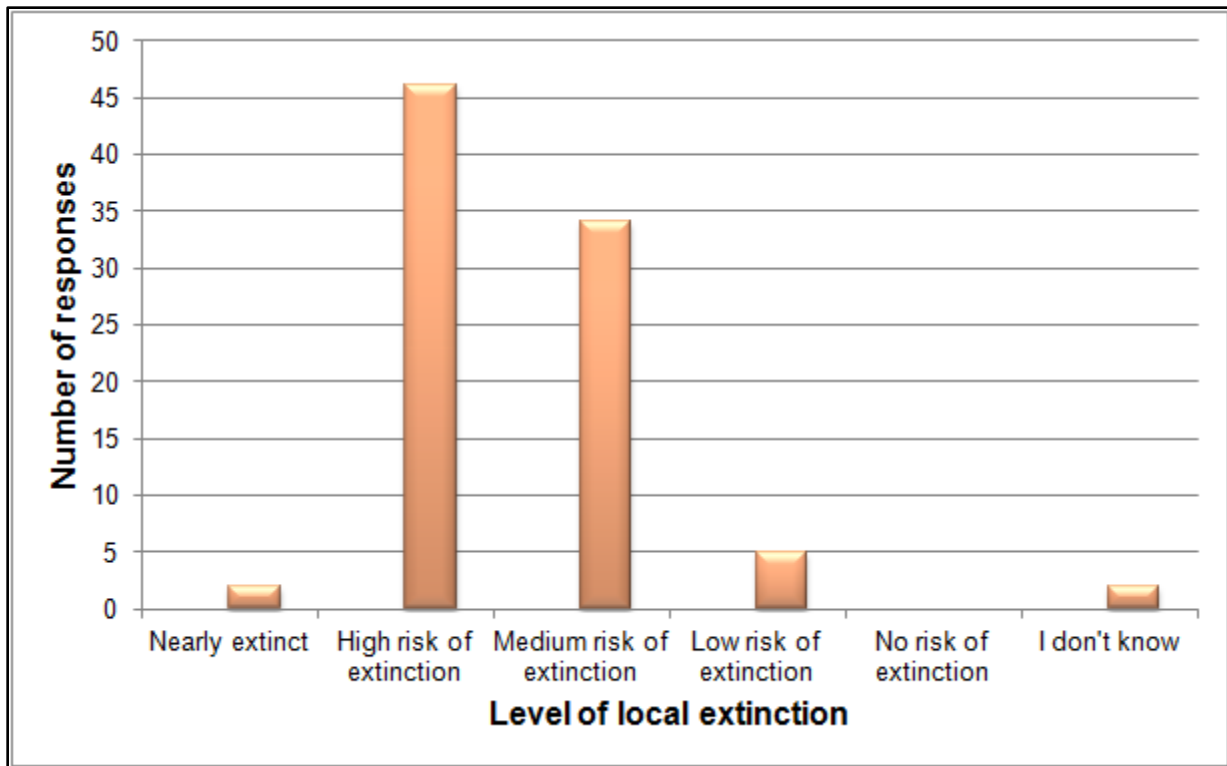

Figure 69: The results of the survey question pertaining to the coral reefs' risk of local extinction in Puerto Rico, n=89

For the final question relating to marine ecosystems (question 14) we asked survey respondents if they believed that boat anchoring puts marine life in danger. We asked this question to determine if there was urgency amongst boaters to stop using their anchors to secure their boats. 49% of survey respondents said that boat anchoring puts marine life in great danger and 40% said that boat anchoring puts marine life in a little danger. Only 10% of respondents thought that boat anchoring did not put marine life in danger. Figure 70 shows the results for question 14.

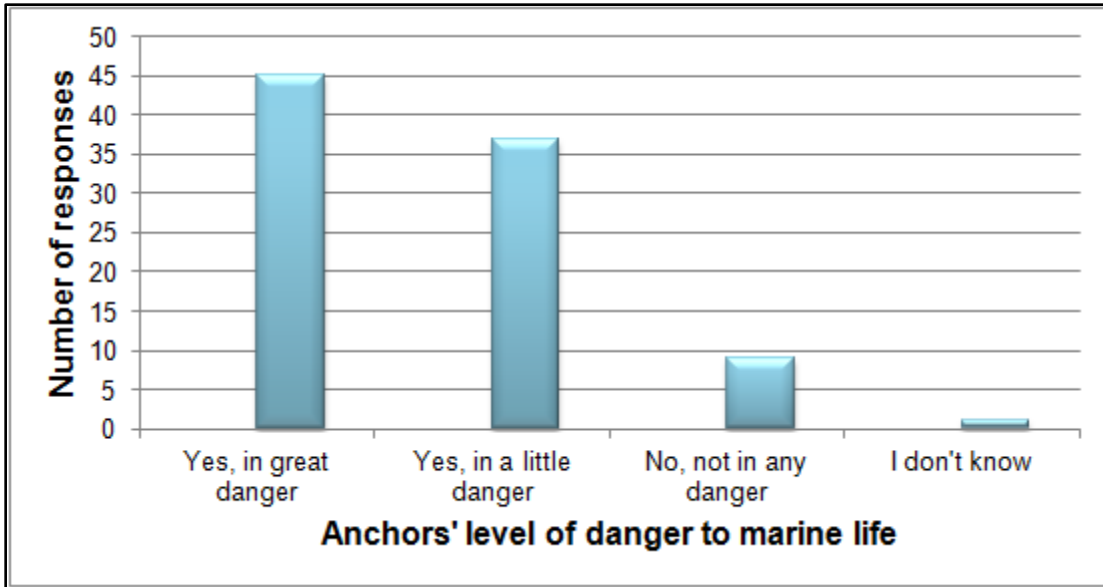

Figure 70: The results of the survey question that asked “Does boat anchoring put marine life in danger?”; n=92

Question 15 asked about the respondent’s knowledge of mooring buoys and their ability to use them. Like question 1, we also separated the results based on how the respondents received the survey. This is because in Culebra, we sometimes reached out to boaters who were using the mooring buoys, which affected the results. Because we were on the DRNA boat, boaters may have felt pressured to give certain answers. The results showed that 100% of boaters surveyed in person, and 94% of respondents from the *La Regata* subscribers know what mooring buoys are and what they are used for. Figure 71 show the results for question 15.

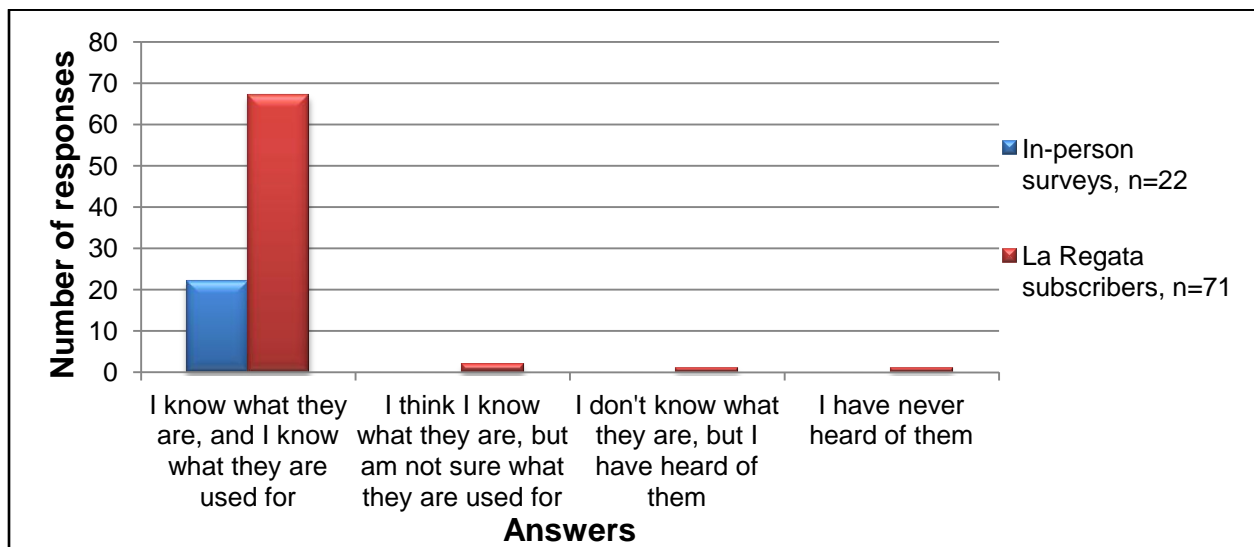

Figure 71: The results of the survey question that asked “Do you know what mooring buoys are and why they are used?”; for the subscribers, n=71 and for the in-person surveys; n=22

Question 16 asked about the total number of mooring buoys located throughout Puerto Rico. Again, we kept answers separated based on how they received the survey. This is because in Culebra, we specifically survey boaters who were using the mooring buoys. The results showed that 3 respondents who took the in-person survey and only 1 respondent who took the survey online chose the correct answer, which is 300+. This represents 21% and 1.5% of the in-person survey respondents and the online survey respondents respectively. The most common response was 0-100, which had 30 responses from the online survey (44% of all online responses) and 9 responses from the in-person survey (64% of all in-person surveys). In addition, 31 respondents said that they did not know the answer. Figure 72 shows the results to Question 16.

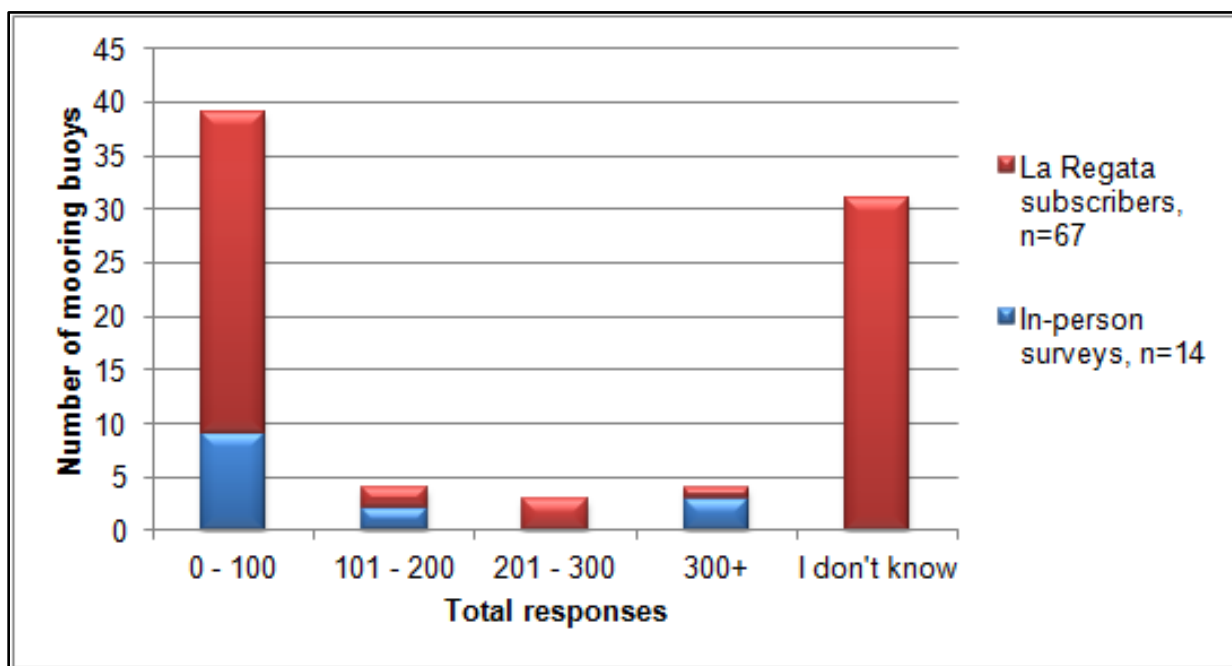

Figure 72: The results of the survey question that asked “How many mooring buoys are there around the cays?”; for the La Regata subscribers, n=67 and for the in-person surveys; n=14

In question 17, boaters were asked to rank their level of agreement on six different statements. Answers ranged from 1- strongly disagree, to 5 - strongly agree. In Table 16, the mean of each statement’s results is shown, as well as the desired range of outcomes for this statement. The two survey groups were kept separate; because we conducted in-person surveys in locations we knew had moorings, which could have had an effect on the answers to these questions. By conducting surveys in person, the sense of anonymity may have been lost, and therefore some boaters might have felt pressured to answer a certain way.

Table 16: The results to question 17

Question	Average (online) standard deviation= ±1.3	n=	Average (in-person) standard deviation= ±1.39	n=
I have seen mooring buoys located around the cays.	3.97	69	3.91	22
I am comfortable with latching my boat onto the mooring buoy.	3.93	70	3.68	22
I use anchors instead of the mooring buoys.	2.63	70	2.68	22
I use the mooring buoys frequently.	3.43	70	3.59	22
I use the mooring buoys and tie together (raft) with other boats.	2.69	70	2.50	22
When I use the mooring buoys, I also drop anchor.	2.13	71	1.73	22

18. If you said “Agree” or “Strongly Agree” to the last statement, briefly describe why:

Text Response
I anchor for overnight stay with plenty of slack as a precautionary measure if mooring breaks. If in the USVI or BVI, no need, i trust those bouys. In PR, The max length is 60' and I have seen 4-5 boats depending on a single mooring, irresponsibly weakening the mooring
the problem with the DRNA mooring systems are the misuse by boating morons and the absolute lack of maintenance by the DRNA
If I am spending the night on a DNR mooring, I sometimes also drop an anchor because I do not trust the moorings fully, given that I have found them to be poorly maintained and many times almost broken off from chafed or broken lines, often times below the water line where the damage is not obvious or in plain view from the boat...
Use the anchor only when there are no moorings and always use them when available.
Do not know the rating of moorings, if they'll hold.
Reinforcement
I rely on the mooring to secure the boat
I never go places with moorings in my boat
Stronger answer
Segunda opción, por seguridad, plan B
Me siento seguro con la boya
Loando se amarra es mejor el bote se mueva
Pienso que el uso de boyas pos permite tener un control y cuida mas los corales y vida marina
Las uso siempre que están disponibles y cuando me voy a dunder a dormir eu el bote
A veces tiro unabregera para estabilizar
para que la lancha no "bornee" en direccion de el viento o la corriente, por seguridad
porque no me voy a soltar y son seguras.
Prefiero amarar

No. Confio en el mantenimiento

No uso ancla cuando me amarro a la boya

Para que la embarcación no cambie de posición

depende del viento

No es necesario el ancla si uso la boya

No tengo confianza en el mantenimiento que se le da a estas boyas para que sean seguras.

las reglas y leyes son para seguirlas si no protegemos los ecosistemas desde este momento nos lamentaremos en el futuro

Me gusta amarrarme a ellas para no utilizar el ancla. Creo que son seguras

Por que no confio en las boyas de amarre. Se de muchas embarcaciones que se van a la deriva por estar amarrados a estas boyas.

para girar el bote hacia la orilla.

Comentraio general: se usan las boyas si estan disponibles; algunas no son totalmente seguras por falta de mantenimiento; se tira ancla tambien si se va a pecnoctar y el mar eta muy movido; se deven poner boyas que el anclaje aguante varios botes por que en PR se hace mucho rafting y es parte integral del boating aqui;

Utilizo el ancla de proa ya que la boya de amarre la utilizo en popa mantener el bote en posicion de no impactar otra embarcacion contigua.

Utiliso la boyas de amare siemre que esten disponible.

Prefiero bornear y así la boya no sufre.

Entendemos que es una forma segura para asegurar la embarcacion por el tiempo que estemos en el lugar en vez de usar el ancla.

Se tira un ancla por el lado en caso de que la boya de amarre se suelte o se rompa la soga. Me ha pasado ya en varias ocasiones que se parte y si no es por el ancla de seguridad, hubiera encayado.

A veces tiro unabregera para estabilizar

para que la lancha no "bornee" en direccion de el viento o la corriente, por seguridad

porque no me voy a soltar y son seguras.

Prefiero amarrar

No. Confio en el mantenimiento

No uso ancla cuando me amarro a la boya

Para que la embarcación no cambie de posición

depende del viento

No es necesario el ancla si uso la boya

No tengo confianza en el mantenimiento que se le da a estas boyas para que sean seguras.

las reglas y leyes son para seguirlas si no protegemos los ecosistemas desde este momento nos lamentaremos en el futuro

Me gusta amarrarme a ellas para no utilizar el ancla. Creo que son seguras

Por que no confio en las boyas de amarre. Se de muchas embarcaciones que se van a la deriva por estar amarrados a estas boyas.

para girar el bote hacia la orilla.

Comentraio general: se usan las boyas si estan disponibles; algunas no son totalmente seguras por falta de mantenimiento; se tira ancla tambien si se va a pecnoctar y el mar eta muy movido; se deven poner boyas que el anclaje aguante varios botes por que en PR se hace mucho rafting y es parte integral del boating aqui;

Utilizo el ancla de proa ya que la boya de amarre la utilizo en popa mantener el bote en posicion de no impactar otra embarcacion contigua.

Utiliso la boyas de amare siemre que esten disponible.

Prefiero bornear y así la boya no sufre.

Entendemos que es una forma segura para asegurar la embarcacion por el tiempo que estemos en el lugar en vez de usar el ancla.

Se tira un ancla por el lado en caso de que la boya de amarre se suelte o se rompa la soga. Me ha pasado ya en varias ocasiones que se parte y si no es por el ancla de seguridad, hubiera encayado.

Estoy retirado y navego mucho, por los cayos y las islas. La necesidad de tener mas boyas de amarte es urgente para proteger el suelo marino y a la misma vez promover el uso de embarcaciones y el turismo náutico que tanto necesitamos.

19. Age? (years)

#	Answer		Response	%
1	under 18		1	1%
2	18 - 25		1	1%
3	26 - 35		11	12%
4	36 - 50		36	39%
5	above 50		43	47%
	Total		92	100%

Appendix E: Rafting mooring survey in English

Qualtrics link: http://wpi.qualtrics.com/SE/?SID=SV_ebAE1NsfWWk9PA9

Survey on rafting mooring buoy designs

Introduction: Hello, we are the students from Worcester Polytechnic Institute who are working on the rafting mooring buoy project. Previously, we distributed a survey regarding mooring buoys and marine ecosystems. Now, we would like to showcase two possible mooring buoy designs that allow rafting without requiring use of anchors. Please give your honest opinion on the following designs. Answers will be kept anonymous.

Here are two different designs with descriptions. These images show parts you will interact with when mooring your boat. Neither design is drawn to scale. The actual number of boats the moorings can support has not yet been determined.

1. *Rope Design*

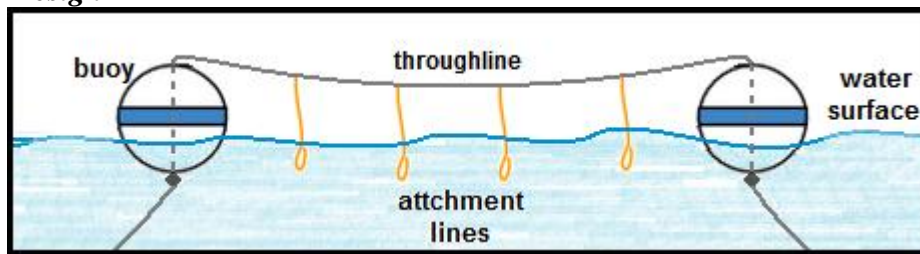

In this design, a polypropylene rope connects the two buoys together. The design is constructed using the current moorings already in place, however it would not replace all of them. You would attach to this rafting mooring the same way you would to a regular mooring. The actual number of boats the mooring can support has not yet been determined.

2. *Metal Rod Design*

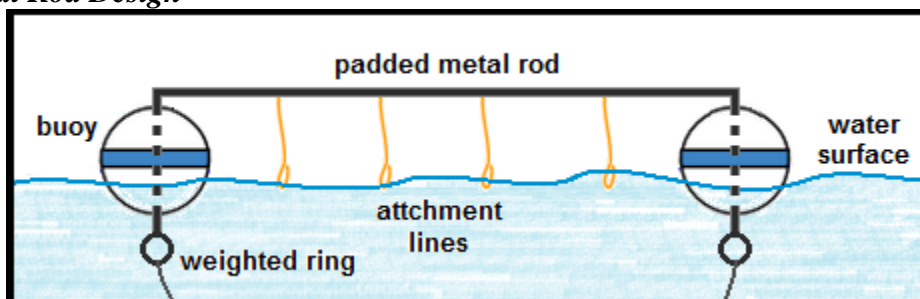

This design is very similar to the polypropylene rope design. The only difference is that a metal rod connects the two buoys instead of a cable. The metal rod is padded to prevent damage to the boats.

- 1: On a scale of 1-5, how easy do you think it would be to moor onto the Rope Design?
- 2: On a scale of 1-5, how easy do you think it would be to moor onto the Metal Rod Design?
- 3: On a scale of 1-5, how comfortable would you feel rafting with other boats on the Rope Design?
- 4: On a scale of 1-5, how comfortable would you feel rafting with other boats on the Metal Rod Design?
- 5: How can we mark the rafting moorings to make them more easily distinguished from a regular, single-boat mooring?

6: What else could be added or changed to make you feel more comfortable using either of these moorings?

7: What additional information would make you feel more comfortable using either of these moorings?

For each of the following statements, please mark the boxes with an X that are associated with your level of agreement on the following statements

	(1) Strongly Disagree	(2) Disagree	(3) Neither Agree nor Disagree	(4) Agree	(5) Strongly Agree
The more boats a rafting mooring can hold, the more likely I am to use it.					
The most important factor for me is the stability of a mooring buoy.					
If I saw a demonstration on how to correctly use a rafting mooring, I would feel more comfortable using it.					

Additional comments?

Appendix F: Rafting mooring survey in Spanish

Qualtrics: http://wpi.qualtrics.com/SE/?SID=SV_55yhTt7MdgUzihT

Encuesta sobre diseños de boyas de amarre compartidos (rafting)

Hola, somos alumnos de Instituto Politécnico de Worcester (WPI por sus cifras en inglés) que estamos trabajando en el proyecto de boyas de amarre compartidos (rafting).

Anteriormente, distribuimos una encuesta sobre boyas de amarre y los ecosistemas marinos. Ahora, nos gustaría mostrar dos posibles diseños de boyas de amarre que permiten el rafting sin requerir el uso de anclas. Por favor, necesitamos su opinión sobre los siguientes diseños. Las respuestas serán anónimas.

Aquí se muestran dos diseños diferentes con las descripciones. Estas imágenes muestran partes que van a interactuar con usted cuando amarre su embarcación. Ningún diseño está dibujado a escala. El número real de embarcaciones que los amarres pueden apoyar aún no ha sido determinado.

1. Diseño con soga de polipropileno

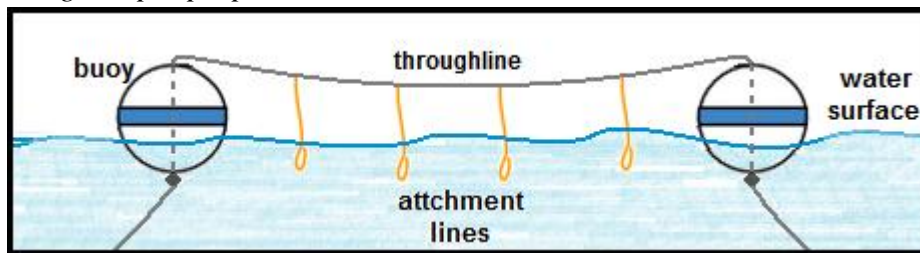

En este diseño, una soga de polipropileno conecta las dos boyas. El diseño está construido utilizando los amarres actuales que ya están en lugar, sin embargo, no reemplazaría todas las boyas. Se podría amarrar a estas boyas de amarre compartida (rafting) de la misma manera que lo haría para un amarre regular. El número real de embarcaciones que el amarre puede apoyar aún no ha sido determinado

2. Diseño de Vara

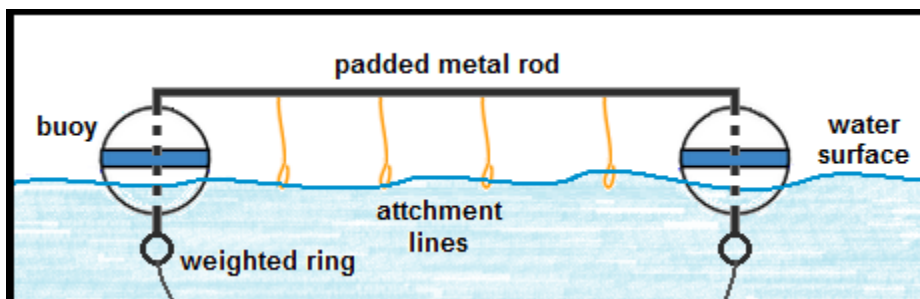

Este diseño es muy similar al diseño de la soga de polipropileno. La única diferencia es que una barra de metal conecta las dos boyas en lugar de un cable. La barra de metal está protegida con goma (foam) para evitar daños en las embarcaciones.

1: En una escala del 1 al 5, ¿cuán fácil crees que sería amarrarse en el diseño de soga de polipropileno?

2: En una escala del 1 al 5, ¿cuán fácil crees que sería amarrarse en el diseño de vara de metal?

3: En una escala del 1 al 5, ¿cuán cómodo te sentirías de estar amarrado con otros barcos en el diseño de sogas de polipropileno?

4: En una escala del 1 al 5, ¿cuán cómodo te sentirías de estar amarrado con otros barcos en el diseño de sogas de polipropileno?

5: ¿Cómo podemos marcar los amarres compartidos (rafting) para que sean más fáciles de distinguirse de un amarre regular?

6: ¿Qué más se podría añadir o cambiar para que se sienta más cómodo con cualquiera de estos amarres?

7: ¿Qué información o sugerencia puede brindarnos para que se sienta más cómodo con cualquiera de estos amarres?

Para cada una de las siguientes afirmaciones, por favor marque las casillas con una X que están asociados con su nivel de acuerdo en las siguientes afirmaciones

	(1) Fuertemente en desacuerdo	(2) Desacuerdo	(3) Ni de acuerdo ni en desacuerdo	(4) Acuerdo	(5) Fuertemente en acuerdo
Mientras más embarcaciones un amarre compartidos (rafting) pueda contener, es más probable que lo use.					
El factor más importante para mí es la estabilidad de una boya de amarre compartida (rafting).					
Si veo una demostración sobre cómo utilizar correctamente un amarre compartido (rafting), me sentiría más cómodo usándolo.					

¿Comentarios adicionales?

Appendix G: Second email to the *La Regata* newspaper subscribers regarding the second surveys

Buenos días Benito,

We are the students from WPI. Thank you so much for sending out our survey. It was so successful, that we would like to send another survey out to the list of *La Regata* subscribers. This survey is a lot shorter than the other one. If you could please forward this message, we would really appreciate it!

Hola, somos alumnos de Instituto Politécnico de Worcester (WPI por sus cifras en inglés) que estamos trabajando en el proyecto de boyas de amarre compartidos (rafting). Anteriormente, distribuimos una encuesta sobre boyas de amarre y los ecosistemas marinos. Ahora, nos gustaría mostrar dos posibles diseños de boyas de amarre que permiten el rafting sin requerir el uso de anclas. Por favor, necesitamos su opinión sobre los siguientes diseños. Las respuestas serán anónimas. No es necesario que todas las preguntas se contesten. Si usted tiene alguna pregunta o inquietud acerca de la encuesta o de nuestro proyecto, en general, siéntase a libertad en enviarnos un correo electrónico a pr14boats@wpi.edu.

Para Español: http://wpi.qualtrics.com/SE/?SID=SV_55yhTt7MdgUzihT

For English: http://wpi.qualtrics.com/SE/?SID=SV_ebAE1NsfWWk9PA9

Please forward this to your list of subscribers as soon as possible. Thank you, you have been so helpful!

Sincerely,

WPI Marine Team

Abdullah

Kaitlin

Kelsey

Sarah

Appendix H: Original email sent to Edwin Rodriguez (Spanish)

Buen día, Edwin:

Espero te encuentres bien. He tratado de comunicarme contigo en varias ocasiones después de la reunión con Julio Méndez, pero sin éxito. Me dijeron estuviste por Parguera. Los muchachos de WPI están preocupados pues necesitan al menos hablar contigo sobre unos detalles técnicos que requieren para el diseño que trabajan. Entre los temas que necesitan discutir contigo sobre lo que has hecho con boyas de amarre está:

- 1)Manta Ray Anchor (tamaños utilizados, manufacturero, material del cual está hecho)
- 2)Boyas de amarre (tamaño utilizado, manufacturero, material del cual está hecho, tipo de engancho para los botes)
- 3)Cadena (tamaños utilizados, manufacturero, material del cual está hecho)
- 4)Otro componente utilizado en el sistema.

Esto es solo una parte de lo que necesitan discutir contigo. Ellos están dispuestos a reunirse contigo cuando les indiques. Pero debe ser pronto, porque no les que da casi nada de tiempo para terminar su trabajo.

Los estudiantes dependen de eso para su trabajo y su nota. Nosotros estamos recibiendo el fruto de su trabajo de forma gratuita, un diseño innovador que trata de resolver un problema que tenemos. Ellos hasta se han pagado su hospedaje y transportación a Culebra para tratar de observar el rafting, entrevistar usuarios y cómo lucen las boyas de amarre instaladas este fin de semana.

Edwin, yo sé que tienes el tiempo complicado, pero por favor, trata de hacer arreglos para al menos hablar con ellos. Necesitan tu información como experto en el asunto. Déjame saber el día y hora que pueden reunirse.

Agradezco tu interés y ayuda sobre este particular.

Aileen

Appendix I: Email sent to Edwin Rodriguez translated to English

Good day, Edwin:

I hope you are doing well. I have tried to communicate with you on various occasions after I met with Julio Méndez, but I have not been successful. They told me that you were in Parguera. The students from WPI are busy, and need to at least speak with you about the technical details required for the design that they are working on. The topics that they need to discuss with you about what you have done with the mooring buoys are:

- 1) Manta Ray Anchor (utilized sizes, manufacturer, what material it is made of)
- 2) Mooring Buoy (utilized size, manufacturer, what material it is made of, type of hook for the boats)
- 3) Chain (utilized sizes, manufacturer, what material it is made of)
- 4) Other component(s) utilized in the system

This is only a part of what they need to discuss with you. They are ready to meet with you when you can. But it should be soon, because they do not have a lot of time left to finish their work. The students depend on this for their work and their grade. We are receiving the idea of their design in gratuity, an innovative design that will try to solve a problem that we have. They have paid for their hospitality and transportation to visit Culebra this weekend to try to observe rafting, interview boaters and look at the how the mooring buoys are installed.

Edwin, I know that you are very busy, but please, try to make arrange to least speak with them. They need your information as an expert on the matter. Let me know the day and time that they can meet with you.

I appreciate your interest and help over the matter.

Aileen

Appendix J: Original response email from Edwin - Spanish

Aileen

Respuestas a preguntas:

1. El fabricante de Manta Ray es Foresight Products: earthanchor.com
Utilizamos el modelo MR-SR3 (es el Manta o plato mas grande). Este plato va adherido a una varilla de acero galvanizado (anchor rod) de 1" x 7' de largo.
Foresight tiene una parte marina (<http://www.earthanchor.com/wp-content/uploads/2012/07/MARINE-INSTALLATION-PROCEDURES-2-9-08.PDF>)
2. La boya que utilizamos es de 18" de Polyethylene rellena de foam polystyrene. ver www.carolinawaterworks.com/products/display/66-18-Mooring-Buoy
3. Usamos 3 tipos de sogas o líneas: 1, Pick up line o la línea de superficie, que es la línea donde se amarran las embarcaciones. es de 7/8" polypropilene (heavy duty y Uv protected), 2, Throughline...esta es la línea que atraviesa la boya. es de 1" en Poly-Plus buoy line (heavy duty, Uv protected), 3. Down line... esta línea es de 1" en Nylon, 3 strand, HD, and Uv protected. 25,000lbs de resistencia.
4. Usamos shackles en Galv de 3/4" para Manta Ray y 3/4" en stainless steel para sistema Halas para usarse en roca.
Para más detalles pueden utilizar la guía de PADI para Mooring Buoy...
http://coralreef.noaa.gov/education/educators/resourcecd/guides/resources/mooring_buoy_g.pdf

El viernes espero reportarme al trabajo

Edwin Rodríguez
Departamento de Recursos Naturales y Ambientales
División de Recursos Marinos
P.O.Box 366147
San Juan, PR 00936
Telf. (787) 999-2200, ext. 2698

Appendix K: Response email from Edwin - translated to English

Aileen

Answers to questions

1. The manufacturer of Manta Ray is Foresight Products: earthanchor.com
We use the model MR-SR3 (it is the biggest Manta o plate). This plate is attached to a galvanized steel rod (anchor rod) 1" by 7' long.

Foresight has a marine part.

<http://www.earthanchor.com/wp-content/uploads/2012/07/MARINE-INSTALLATION-PROCEDURES-2-9-08.PDF>

2. The buoy that we use is the 18" Polyethylene filled with polystyrene foam. See www.carolinawaterworks.com/products/display/66-18-Mooring-Buoy
3. We use 3 types of ropes or lines: 1, Pick up line, or the surface line, is the line where the boats are moored. It is 7/8" polypropylene (heavy duty and UV protected), 2, Throughline...this is the line that goes through the buoy. It is 1" in Poly-Plus buoy line (heavy duty, UV protected), 3, Down line...this line is 1" thick made of Nylon, 3 strand, HD, and UV protected. 25,000 lbs of resistance.
4. We use shackles en Galva 3/4" for the Manta Ray and 3/4" stainless steel for the Halas systems that are used for rock
For more details, they can use the PADI guide for Mooring Buoys....

http://coralreef.noaa.gov/education/educators/resourcecd/guides/resources/mooring_bouy_g.pdf

On Friday, I hope to be at work.

Edwin Rodríguez

Departamento de Recursos Naturales y Ambientales

División de Recursos Marinos

P.O.Box 366147

San Juan, PR 00936

Appendix L: List of costs for one mooring buoy

The following list contains the costs for all of the parts and overall installation of a mooring buoy. This information was provided by Edwin Rodríguez.

Manta Ray (MR-SR) anchor	\$300
Mooring Buoy	\$160
Galvanized shackle ($\frac{3}{4}$ "	\$15
Rope	\$100
Small buoy	\$9
Chafing hose	\$7
Cable tie	\$7
Total Material Cost	\$600-\$700
Installation	\$1,300-\$1,500
Total Overall Cost	\$1,800-\$2,200

Appendix M: Components and prices of a mooring buoy

Table 17: Different components of mooring buoys and machinery with prices (NOAA, 2005)

Component/Machinery (Price)	Use and Importance
A Manta-Ray anchor Model MR-SR3 (\$110-125)	Used as the main anchor for the moorings
A helix anchor (\$700 - 1000)	Alternate anchor; can be used for additional support
A fish plate (\$20)	Used for double anchoring mooring
A stinger dive gad set (\$899)	Extractor bar
A hydraulic loader locker (\$1886)	Used to toggle the Manta Ray anchors
An underwater Jackhammer (\$2050)	Hydraulic underwater drill
A hydraulic Power Unit 18 HPW (\$4300)	To power all the hydraulic equipment
A hydraulic Hose (\$4.95/ft)	To be used with the hydraulic equipment
A stainless Steel Hydraulic Couplers set (\$125)	To regulate the hydraulic hose; does not rust underwater

Appendix N: Mooring buoy inspection techniques

Table 18: A table showing different inspection techniques US Navy uses for mooring buoys (US Navy NAVFAC MO-124, 1987).

Inspection Type	Description
Annual Surface Inspection	Yearly inspection of the visible portion of the system once a year to ensure that there is no physical damage to the buoys; also to verify that the buoys are in their proper positions
Underwater Inspection	Inspection of the chain assemblies underwater every 2-3 years
Failure Inspection	When moorings are damaged by collisions or dragged out of position due to weather or sea turbulence, the extent of the damage should be analyzed at the earliest opportunity

Appendix O: Informal Interview with Carlos Matos

Carlos Matos, DRNA biologist

F-27 Mooring Buoy Project Involvement: Surface support & Administration

Interviewed on Tuesday, December 9, 2014

How did you get involved in this project?

Team before needed help, they stepped in due to their prior preparations and knowledge

Need for alternative to anchoring

Idea for *F-27 Mooring Buoy* project from *Florida Cays National Marine Sanctuary Buoy Program*

What steps were taken to complete the project, and how long did each take? (prior studies, permits, collecting materials, construction)

The protocol is as follows:

Literature research

similar systems- pros & cons

What did they do right/wrong (permits and everything)

Joint-permit process

Apply through Army Corps of Engineers→ to authorize DRNA to install buoys

State/Federal government must approve environmental impact statement

published in papers & distributed through other means→ based on community feedback, it is accepted or denied

1 month - 1 year process

strict procedure that must be followed

Installation process:

Each mooring costs about \$2400, including materials, machinery, manpower

1 mooring install→ depends on substrate, 30mins-1hr, about 320 moorings around Puerto Rico as of today

Begins with under-water assessment→ 2 divers large rod to determine best area for anchor

Manta- long shaft, spear anchor, load locker (for softer sediment)

must take depth into consideration

don't normally go deeper than 60 ft.

More moorings in shallow water to protect those areas more

Those farther away are to accommodate larger vessels

Can use dinghy/smaller craft to get to shore/cay

Example: Las Pelás has dimpled geography (slopes)

Put moorings in at angle

2 were moved to deeper water for larger vessels

Main goal was to protect cay from larger vessels

How were the moorings marketed?

Videos at diving schools
Videos in boat safety courses
Pamphlets/handouts at marinas and boat shows
Interviews to see if people retained knowledge

How did the boaters react to the moorings?

Initially- negatively, thought they were for privileged boaters only
Buoys were vandalized as social protest
Talked to community leaders→ answered questions and gained trust
Once [boaters] found out they were paid for through taxes (government budget), began to protect them more, like their own property

DRNA still connects with community leaders, specifically elders→ held at highest respects
Must keep information running down generations of community leaders
Always new questions to be answered, especially now- in a time of deterioration of trust in government

Why are anchoring fines not enforced more strictly?

DRNA prefers conciliation rather than punitive action
Talk to someone before fining them
Change their attitude towards moorings and the environment is more important
gather more making sure they understand rather than making them face the law
Civil code vs. penal code
Civil is lenient- shame makes [anchoring] not happen again
penal code strong, but still has a soft side (ex: first offenders)

Has there been any physical damage to the buoy systems? And is there a routine maintenance plan?

Down lines attract marine life
Vegetation, and fish that feed on it
Don't tend to clean downlines- don't want to disrupt life
Regular maintenance monthly/annually depending on area
East of island, and in cays- monthly
More traffic→ more maintenance
Aerial photographs taken by DRNA use to determine areas of high traffic
Up to 2 hrs to maintain one mooring buoy
Each year, develop proposal for purchase of new materials & plan for leftovers
If change in design→ new permissions needed
Only a report of year's activity needed to keep same designs

Encountered moorings beyond repair- animal, environmental, and human causes
Found shark teeth in some buoys
Misuse, people don't know how to approach the mooring buoy→ run it over

Is there anything you wish was done differently?

A lot of things:

permits easier to obtain
availability of materials (buying)
more proficient outreach program
address concerns and doubts of community
participation of community (government and non-government)

Any advice, additional information that may be useful for this project:

Big problem with rafting→ Puerto Ricans love people
Aerial photos from key points during the year show rafting
That type of boat concentration has large impact on marine life
Want to see more calculations for the [rafting mooring] design
DRNA has begun to use helix moorings
Matias cay- using helix due to sediment
Harder to install, requires much physical strength from divers

Appendix P: Raw data for survey #2

2. How can we mark the rafting moorings to make them more easily distinguished from a regular, single-boat mooring?

Text Response
special color
Different color buoys?
Different Color
NA
Different color
Id with a different color on nav chart
something like a diving flag attached to middle of rope between moorings
Bright colors
Were do they have this mooring design.
place small pool type buoys in the mooring rope between the main mooring buoys
Small flags.
Different Color
by color code
The bouys could be color coded (other than white or orange.
2+
con color brillantes o sogas con tejido fosforecente
De color naranja fluorescente
Determinando un color llamativo
Con colores o banderas desde la boya.
No deben existir amarre compartidos
franja vertical roja y verde, o verdde y roja
Usando bandera o algun color fiferente
con colores siferentes
con una boya de color brillante
Rotular cada boya : "Amarre compartido solamente" o "Rafting Only"
La encuesta está muy ambigua y quedan cosas si explicar. Por ejemplo que pasará con la proa o el extremo de la lancha que no quedará amarrado. Además no preguntas el tamaño de la lancha ni el lugar donde estará ubicada la boya.
Utilizando colores
con banderas
Dos verdes y dos rojas.
Banderin y/o diferente color
boyas màs pequeñas que las regulares
colores o algun tipo de marca
Colores brillantes como anaranjado, fosforecente y que flote para poder verlo y agarrarlo.
Diseno de boya diferente a los conocidos, color llamativo

Statistic	Value
Total Responses	35

3. What else could be added or changed to make you feel more comfortable using either of these moorings?

Text Response

nothing, rafting is only safe when wheather permits

I'm concerned about the use of metal in the marine environment. Even stainless steel corrodes quickly in salt water. Maintenance and strength could be an issue.

Add a Third morring to prevent boats from swinging

You are not considering the wind shifts on these designs. The boatswill not be able to swingon these designs, creating mess and piled up when the wind runs parallel to the two bouys

Nothing

some sort of light (with color code for the pair) or reflector to be able to appreciate rope between moorings

Regular maintenance

These design are for small boats.

design looks ok

Foam rings on rope loops would keep them floating for easier pick up.

This systems coul be used for non overnight and for smaller boats less that 30 feet

the metal rod should be stainless steel or could also be of carbon fiber to make it lighter to handle.

sogas con sistema de resorte o espiral. ademas creo boya debe tener 2 puntos de anclaje a 45 grados

Luz intermitente solar y cintas reflectores

algun letrero con normas y especificaciones

Doble anclaje en el fondo para cada boya.

Igual a la anterior

La distancia entre boya y boya debe ser 6' para amarrarse 2 botes cómodamente de entre 17' y 25' anclados al fondo con cadenas envez de sogas

el largo de la sogas que sea mas largo

La longitud de los amarres para así los barcos no choquen

prefiero las boyas solas por tamano de embarcacion

Rotulos informativos cerca de las boyas. Educacion.

En forma de cruz, pero el viento puede mover las embarcaciones unas contra otra. El diseño de arriba es mejor si las embarcaciones dejan espacio para que otra embarcación se amarre.

mas disperso

Dejando saber cuantas embarcaciones y de que tamaño pueden estar a la misma vez.

poner boyas regulares paralelas una con la otra a x distancias y los dueños de los botes se amarren en rafting sin todos tener que usar anclas de proa o popa.

El espacio entre los amarres es lo mas importante. Que no queden muy cerca uno del otro.

Statistic	Value
Total Responses	16

4. What additional information would make you feel more comfortable using either of these moorings?

Text Response

nothing, rafting is only safe when wheather permits

If boaters aren't used to the rafting hardware, they may over shoot the moorings and their propeller could cut the horizontal line. Also, the metal rod may affect the stability of the buoys, tipping them until the rod is in the water and not visible to boaters.

None. They will not work. Read a boat book om rafting.

I personally dislike the metal rod concept for the following reasons; (1) salty environment make it susceptible to corrosion, (2) Poor visibility will increase liability issues, (3) How do you free a keel from the metal rod version ?

tether strength

Information regarding set up and maintenance

Distance/separation between attachment lines

MORE SINGLE MOORINGS.

Knowing main buoys anchoring system. Screw? Concrete block? Etc

Data on safety # and size of boats allowed

anchoring should have good publicity.

Que las boyas tengan un teléfono a donde llamar si se dañan

mantenimiento y limpieza a las sogas / boyas e identificar este servicio en la boya para saber que ha sido revisada y se aprueba su uso

Que las líneas de amarres sean en zigzag

Buena orientacion en las diferentes rampas y lugares donde se coloquen las boyas..

Incluir informacion de que tipo de embarcacion y pietaje puede utilizar estas boyas.

Mientras mayor espacio entre emares, mejor

Igual anterior

El amarre siempre tiene que sujetar directo del frente y no que haga fuerza hacia el lado

ademas de las boyas delantera una trasera

que le den mantenimiento a las boyas

MI recomendación es que cambies el diseño del estudio. Ahora estás trabajando en una encuesta cuantitativa y esto limita la cantidad y calidad de la información que recogen. tal vez podría utilizar un diseño mixto en el que colocaran de manera experimental una boya y le pidiesen a diferentes usuarios que tratase de amarrarse a la boya. Evaluar como es la experiencia del nauta en las diferentes dimensiones.

La de amarres con la barra de metal puede traer problemas con el pasar del tiempo ya que puede degenerarse

ponerles banderas

Este amarre esta hecho para lanchas, yo tengo velero y no me siento comodo.

Marcando en la boya una fecha de inspección como mes y año para saber que fueron inspeccionadas por alguien.

que las agencias pertinentes esten pendientes que se sigan las reglas.

indicar capacidad de sujecion de las boyas y la eslora de las embarciones permitido.

Statistic	Value
Total Responses	29

Appendix Q: Strategic plan

Our project, *Designing a Rafting Mooring System for the Puerto Rican Cays*, was intended to aid the DRNA in their goal of protecting coral reefs and seagrass bed around Puerto Rico by creating a mooring buoy design that accommodates rafting behavior. The following strategic plan highlights results and recommendations from that project that could be of use to the DRNA when implementing our design. The plan is separated into an installation plan and a promotion plan. The installation plan gives details on where the DRNA should build these systems, and includes images of existing buoy pairs that the systems could be built on, as well as recommendations for maintenance of the rafting moorings. The promotion plan contains findings from our surveys and informal interviews organized into recommendations to promote our rafting mooring.

Installation Plan:

We determined through responses of our first survey, where the rafting moorings should be placed based on how popular the locations were for boaters. Through the GIS database using *Google Earth* imagery that was provided to us, we were also able to determine where these systems would be feasible based on average distances between two parallel buoys and the ocean depth at that location. Areas found to have buoys in locations that would work with our design are Las Pelás, Dakiti, Playa Tortuga, and Palomino. These locations were chosen because they were found to have buoys at a distance apart and water depth that would be cohesive with our design. This does not mean other locations are not suitable for our design, but alternative locations would require more detailed calculations and measurements than we were not able to achieve in the project time allotted. The following figures (Figure 73 – Figure 76) depict these location and pairs of buoys that could be used to create our rafting mooring design. Table 19 shows buoy pairs and their respective distances from each other, as well as estimated water depth at each pair. The total rope needed to convert each buoy pair into a rafting mooring is also given in this table.



Figure 73: Possible locations for rafting moorings at Las Pelás



Figure 74: Possible locations for rafting moorings at Dakiti



Figure 75: Possible locations for rafting moorings at Playa Tortuga



Figure 76: Possible locations for rafting moorings at Palomino

Table 19: Lists of buoy pairs, distances, water depths and rope needed to complete that design

Location-Pair#	Distance between buoys	Water Depth (ft)	Total Rope Needed (ft)
LasPelas-1	150	10	164
LasPelas-2	181	10	196
LasPelas-3	170	10	184
Dakiti-1	170	6	180
Dakiti-2	175	6	186
PlayaTortuga-1	140	5	147
PlayaTortuga-2	150	5	157
PlayaTortuga-3	160	5	168
Palomino-1	162	6	171
Palomino-2	150	6	158
Palomino-3	170	6	180
Palomino-4	162	6	171

In order to install a new system, the equipment must first be purchased. Appendix M shows a list of costs of components needed to construct a mooring buoy provided by the DRNA, while Appendix N shows equipment required to install a typical mooring buoy system by the NOAA. The DRNA already has this equipment stocked at their storage warehouse. Our system is going to be constructed on existing buoys in place making the whole process easier and more cost-effective, compared to installing a brand new mooring buoy.

To construct our rafting mooring, a simple extension of the throughline is needed to connect the buoys above the surface. The throughline should be tied underneath the first buoy and connected to the downline normally as with a standard mooring installation. This can be seen in Figure 77. However, unlike the installation of standard DRNA mooring buoys, our rafting mooring throughline does not connect immediately to the attachment line on the other side of the buoy. Instead it continues above the surface of the water to the other mooring buoy, at a distance of 130 feet away, and is tied under the surface and connects to the other downline. This distance was chosen to accommodate the maximum number of 7, 40 foot boats, with extra room for rafting buoys. **We suggest that attachment lines be placed every 18 feet along the 130 foot rope. We also believe the DRNA could place extra support buoys in between the main buoys to prevent the throughline from sagging into the water.**

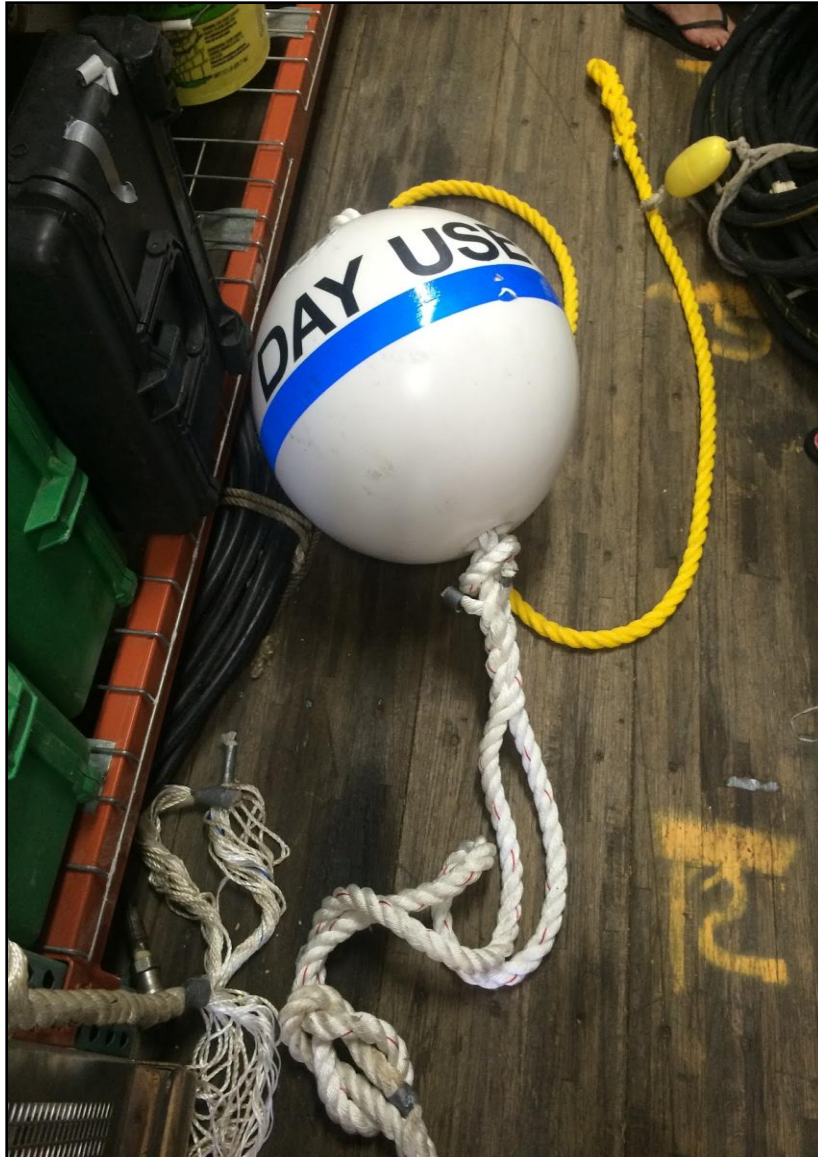

Figure 77: Knot linkage of a standard DRNA mooring buoy

A popular suggestion by the boaters (from the second survey) was to change the color of buoys that are used for rafting moorings. By doing this, the DRNA would help boaters distinguish between the rafting mooring buoys and the traditional single buoys. If the DRNA installs the new systems with buoys that are not different from the existing ones, people may either continue misusing single buoys or may use the rafting mooring buoys with a single boat, therefore defeating the purpose of the new rafting mooring buoys. **We suggest that the DRNA takes this feedback from boaters into consideration, and makes the color of the rafting mooring buoys different from the regular mooring buoys.**

The DRNA's schedule is heavily dependent on periodical analysis of aerial photographs of the buoys. If damage is shown through these photographs, only then the DRNA works on the maintenance of traditional single buoys. However, as the rafting mooring buoys have a more complex design than the normal buoys they would need more attention as well. **We suggest that in addition to their normal methods the DRNA could physically go to the new rafting mooring sites and maintain them by following the schedule given below:**

Maintenance schedule

1. **Monthly maintenance:** Clean downline or replace if required.
2. **3-Month maintenance:** Replace the shackles between attachment line if needed. Look for damages to the buoy, and replace it with a new one if necessary.
3. **6-Month maintenance:** If there are signs of movement, anchor or mooring buoy should be put back in place. Buoys should be replaced if they are damaged as well.
4. **Year maintenance:** Replace the shackle that is located between the attachment line and buoy. Look for damages to the downline, attachment lines and throughline and if needed replace the lines which show extensive damage.
5. **Bi-yearly maintenance:** Replace downline, attachment lines and through line completely with new ones even if the lines look fine.

Promotion Plan:

Through our surveys, interactions with the boaters, and results from our previous methods, we created a promotion plan for the rafting mooring system. This section gives suggestions to the DRNA to reach the highest number of people and also how to make sure that boater's concerns are addressed.

We learned through our informal interviews, with the DRNA staff, about some challenges the DRNA had to face with the F-27 mooring buoy project in its initial years. People reacted negatively to the buoys initially. People had rejected mooring buoys to such an extent that some of them were even vandalized. The DRNA then concentrated on community leaders and elder citizens of Puerto Rico to help them convince the younger generations to accept the mooring buoys. In Puerto Rican and other Spanish cultures, young people pay heed to the suggestions of their elders (C. Matos, Personal Communication, 2014). After that, the DRNA saw that people

had stopped vandalizing the mooring buoys, and started using them. **We suggest that once the rafting mooring buoy is built, field-tested and finalized (not just our final design), that the DRNA once again involve older generations in the process of implementing the design.** In doing so, the new systems will have a better chance of being accepted.

While we surveyed the boaters, we noticed that a lot of them dropped anchors while they used the mooring systems. Figure 78 is a picture taken at Las Pelás which shows this behavior.



Figure 78: Boaters engaging in rafting while dropping anchor and using mooring buoys

When we inquired about this behavior, we were surprised that a lot of boaters do not trust the mooring buoys to be effective. A couple of boaters even responded that they feared that the anchor of the mooring buoys may be uprooted. When asked what will make them comfortable to use our rafting mooring system, a lot of responses were that if they were given specifications of how much tension a single mooring buoy can hold that they will be more comfortable using them. Some of the responses explained that if respondents were given specifics of how and when mooring buoys are maintained, then they will be more comfortable with using them. **We suggest that the DRNA, in their future public service announcements, educate the boaters about how strong the new systems are. The DRNA should also make their mooring buoy maintenance plans more publically available, in order to undo the existing mistrust.**

Another suggestion obtained through our second survey is that boaters think that they will be more likely use the new rafting mooring if they saw a demonstration of how the rafting mooring system works. **Therefore, we suggest the DRNA to publicly demonstrate how the rafting moorings are properly used.** This will show boaters proper usage of the rafting mooring, and will restore their confidence in mooring systems as a whole. Additionally, this public exhibition should be videotaped and uploaded on the DRNA's website for it to be readily available.

Because had multiple means of surveying the Puerto Rican boating community, we can deduce what means of spreading information are the most effective for reaching out to the boaters. The following are the results of the various methods we used in communicating information:

1) Facebook Page and Posts: Our page had reached 839 people in the first four days. However, we saw that only 108 people "liked" the page. This means that only 12.2% of the people who saw our page actually subscribed to get more posts and information from our page. Anyone that has a Facebook account can also see the page and therefore can like it. This means that they do not necessarily have to be a part of the Puerto Rican nautical community, which is our targeted audience. We saw that Facebook is an effective way to reach out people, but it does not necessarily translate into desired results. In order to know how many users of the page are from Puerto Rico, polls can be made on the Facebook page to determine where the people who liked the page are from. Additionally some of the people who liked this page were our friends from WPI that means not everyone who liked our page was a Puerto Rican boater. Figure 79 shows a screenshot of our Facebook page and the number of likes it has received.

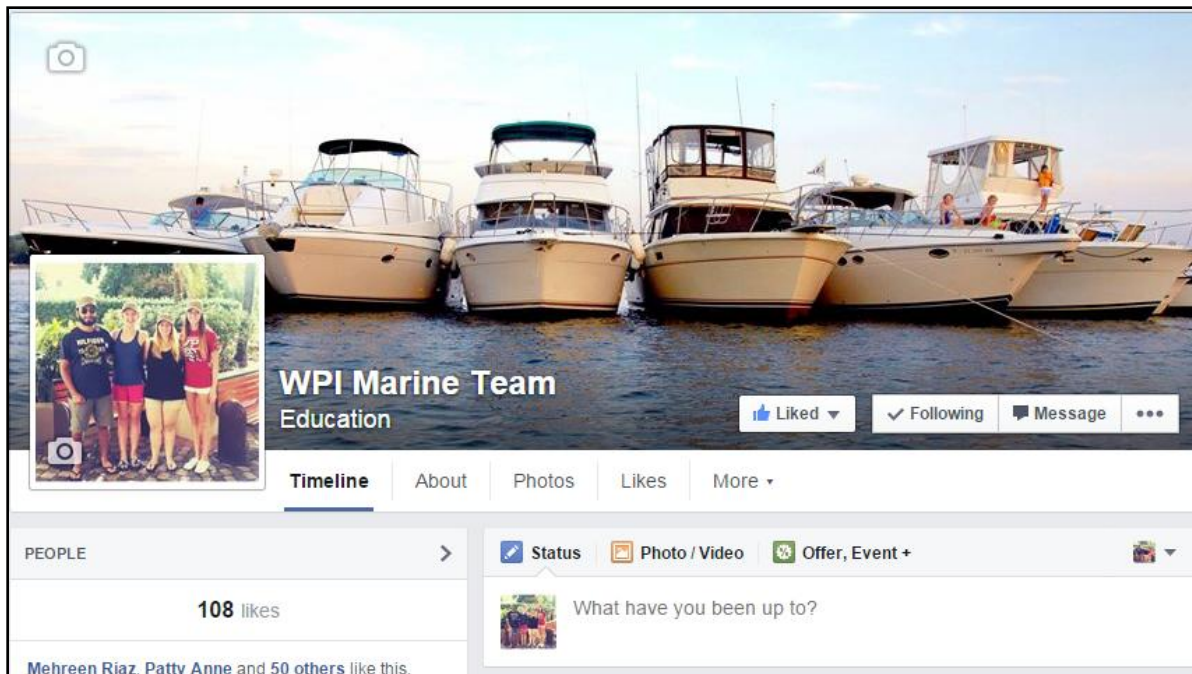

Figure 79: shows the layout of our Facebook page.

We suggest that the DRNA create a Facebook page much like the one we did. By doing this they will not only reach a bigger audience, but the DRNA will also have the option to statistically analyze the people who have liked their page to the number of likes, comments and views of their posts. Figure 80 shows some of the statistical tools available for the owners of any page. These tools show statistical data on audience engagement, page likes, and post reach. By analyzing statistical data, the DRNA can keep track of the performance of the page and make improvements to it. This service is free of charge.

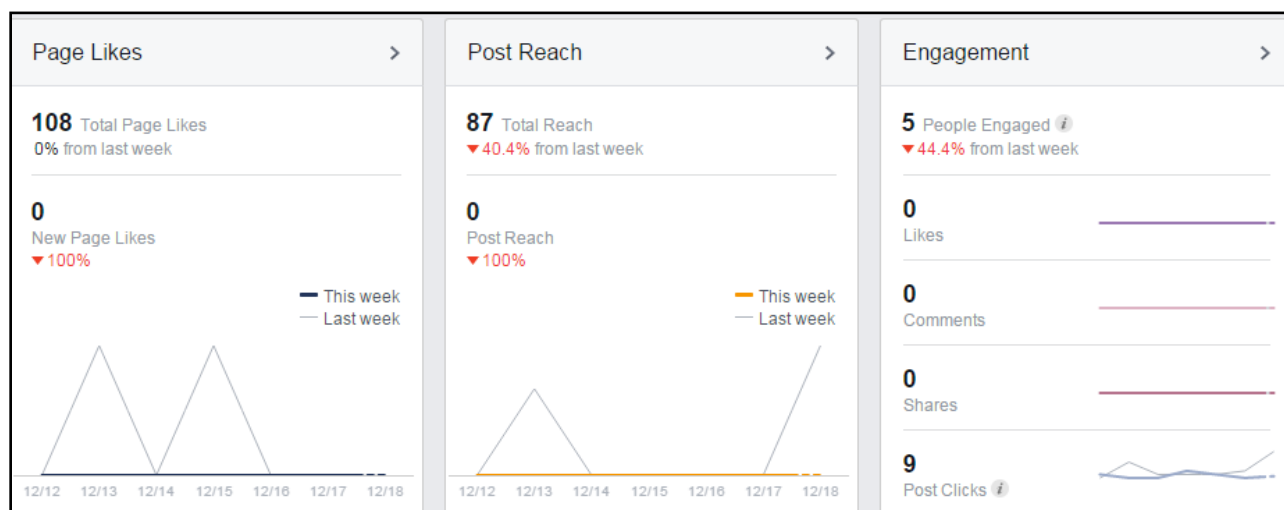

Figure 80: Information showing statistical tools that Facebook offers for page owners

This is probably the easiest way to reach out to people, and the page can easily be maintained by anyone at DRNA who has a Facebook account. In addition, Facebook also provides a paid promotion service, through which a sponsored page appears in the Newsfeed section of its users. This page appears as a result of the users' interests and browsing history, therefore Puerto Rican boaters who may have liked other boating pages but do not know about the existence of a DRNA page can see the page when they scroll down their Facebook homepage. **We recommend that a "DRNA Marine page" be created to engage a wider audience of boaters.**

2) **La Regata Newspaper subscriber's list:** Our survey was sent out to the subscribers of the newspaper. We received 74 responses in less than 2 weeks. Although anyone can subscribe to this newspaper, *La Regata's* main audience is still boaters. As the most number of responses we received were from the mailing list of this newspaper, we think emailing subscribers of various magazines and newspapers is an effective way to reach out to them in the future as well. As part of our promotion plan, we suggest that the DRNA should write articles for the boating community to update them about ongoing or upcoming marine projects in such newspapers. By looking at the number of subscribers of *La Regata* (6,422) we can assume that a lot of people read them. **We also suggest emailing monthly newsletters to boaters as it is an effective way to keep boaters in loop of the DRNA's plans.** This may be beneficial in collecting feedback through surveys as well. *La Regata* has a subscribers' list of 6,422 people. The number of people who read our email about our surveys was 743. This was 11.57% of total subscribers. Even though not all of the people who read our email took the survey, it is still encouraging that almost 12% of the people did. The DRNA has access to personal details of more than 30,000 active licensed boaters (A. Velazco, Personal Communication, 2014). **If that that database to reach out to them in the form of weekly to monthly newsletters in both print and email at a 12% success rate, the DRNA will reach at least 3,600 boaters.** This way the DRNA can move forward with their future projects in a more collaborative way.

3) **In-person Surveys:** Visiting the San Juan bay marina, and the popular boating sites around Culebra we spend a total of 7 hours there and reached out to 23 people, and 22 of them took the survey. This yielded a 95.7% success rate.

Although this was is the most time consuming of our strategies, we still believe it is an effective way to reach boaters. **The DRNA can distribute pamphlets among the boaters by the DRNA rangers.** The rangers can also talk in person to a certain number of people to promote the new systems. We suggest that the rangers, who perform vigilante (ranger) duties in the waters surrounding Puerto Rico, should have a weekly quota of talking to at least 30 boaters per week. If this is becomes a reality, a ranger will have reached 120 boaters in a month, and 1440 boaters in a year. **We believe that this is also a good way of promoting DRNA initiatives among the boaters, and also a way of getting live feedback.**

Appendix R: Calculations for rafting mooring designs

From our first survey, we asked about the lengths of the boats that the boaters drive (see Appendix A). We then chose the highest value from each range to do additional research on. These values were 16 feet, 26 feet, 40 feet, and 60 feet. Knowing this, we randomly selected boats with these lengths for our SolidWorks designs. We researched values such as width, height, dry weight, and maximum capacity. The following table depicts what boats we selected to use for our calculations.

Table 20: Dimensions of specific boat brands

Length [ft]	Name	Year	Type of boat	Width [ft]	Height [ft]	Dry weight [lbs]	Max. Capacity
16	Campion Allante 485 Forster	2014	Fishing	6.5	4.167	941	5
25.5	Bryant 225	2015	Deck	8.5	7.75	4,460	13
32.5	Bayliner 3355B	2012	Express cruiser	11	9.83	12,015	12
44.167	Arimot 45	2015	Flybridge	14.33	13.22	37,479	Yacht certified

From our results our first survey, we learned that the most popular boat sizes are below 40 feet. Therefore in our calculations, we used the height and width of the Arimot 45 because we want to generate the largest drag force created by the wind. This would be accomplished by wind pushing up against the largest area, which can be generated by using larger boats.

To calculate the total forces acting upon the design, we first looked at the total forces acting upon the rafting mooring. Because of the locations of the moorings are so close to shore, there is minimal wake. Therefore neither the boats nor the buoys will move vertically (in the y-direction). With the boat being on the ocean, there will be a constant force in the negative y-direction from the acceleration of gravity acting upon the mass of the boat. However there is also a buoyant force in the positive y-direction that keeps the boats afloat. These two forces cancel each other out, making the total force in the y-direction 0.

We first calculated the strength of the ring link design. To do this, we first constructed a free-body diagram of the forces. Figure 81 shows the free-body diagram of forces acting upon the ring link design underwater.

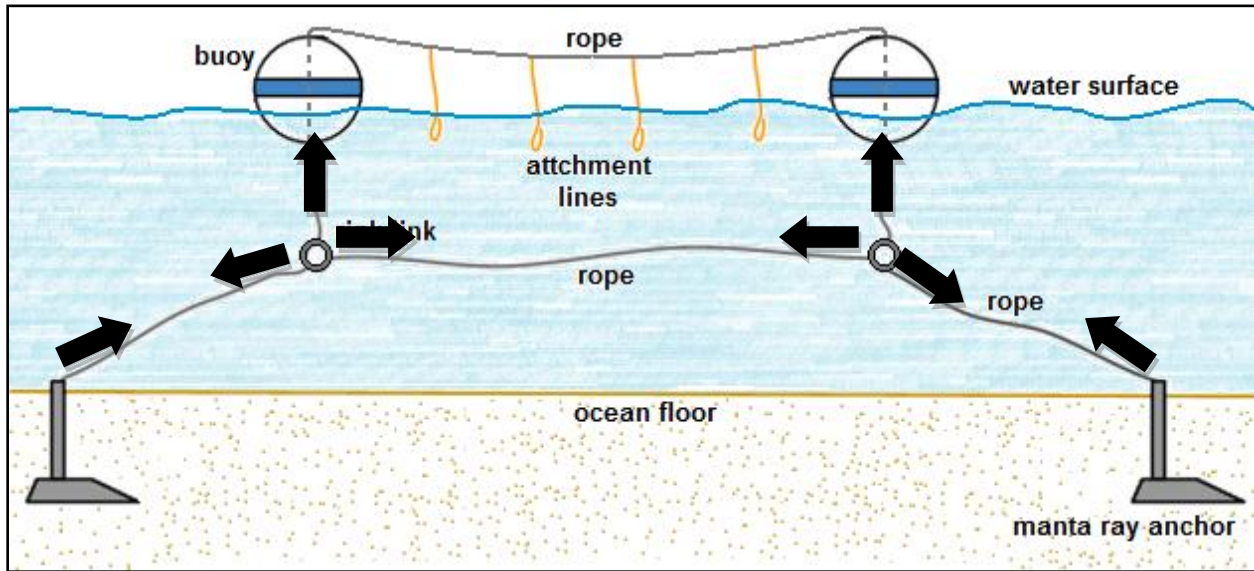

Figure 81: A free-body diagram of underwater forces acting upon the ring link design

From previous research done by Bouchard et al (2013), we know that the coefficient of drag (C_D) of an object on the ocean is .04, the density of air (ρ) at 85° F and 70% humidity is .0717 lb_m/ft³, and the maximum velocity (v) of wind is 67.5 ft/s. These values are based on a very humid and windy day in Puerto Rico.

We decided that we wanted the angle between the ocean floor and the downline to be at least 45 degrees. This is so the downline does not drag along the ocean floor because this would create dead zones (C. Matos, personal communication, 2014).

The Manta Ray anchor was strength tested by the NOAA to withstand a load of 7,500 pounds (Bouchard et al, 2013). The rings in this design are made of hot-dip galvanized steel, which has a yield strength of 40,000 psi. Because the Manta Ray anchor's yield strength is significantly lower than the yield strength of the ring, the Manta Ray anchor would fail before either of the rings would. Therefore, we need to look at the forces acting upon the Manta Ray anchors. Because we have two Manta Ray anchors in our design, the total strength of the ring link design is 15,000.

$$F_D = \frac{1}{2}\rho(v^2)C_D W_B H_B B$$

Because our ideal angle between the ocean floor and the downline is 45 degrees, we multiplied 15,000 by the Cosine of 45 degrees.

$$15,000 \cos(45^\circ) = 10,602.38 \text{ pounds}$$

We then substituted in all of our given variables from the first two calculations.

$$10,602.38 > \frac{1}{2}\rho(v^2)C_D W_B H_B B$$

$$10,602.38 \text{ lbs} > \frac{1}{2}(.0717 \text{ lbm/ft}^3)(67.5 \text{ ft/s})^2(.04)(16 \text{ ft})(13.22 \text{ ft})B$$

$$B = 7 \text{ boats}$$

Therefore, the ring link design has a strength of 10,602 lbs and can support 7 boats.

After we evaluated the ring link design, we calculated the strength of the helix design. To do this, we constructed a free-body diagram of the forces. Figure 82 shows the free-body diagram of forces acting upon the helix design underwater.

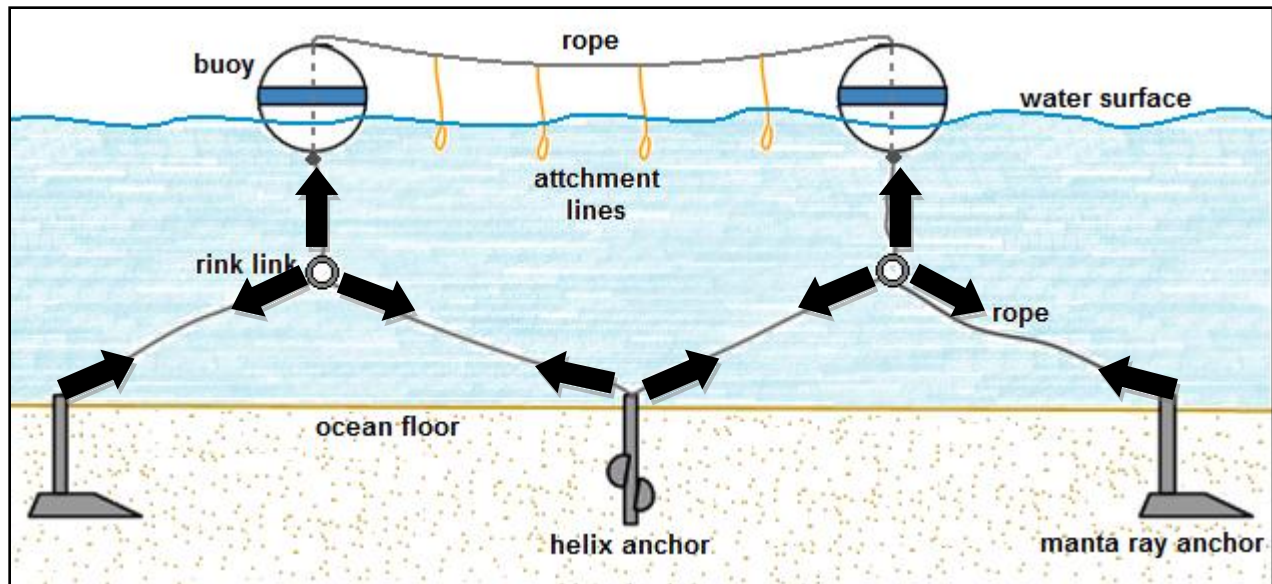

Figure 82: Free-body diagram of forces acting upon the helix design underwater

Once again, we used a strength of 7,500 lbs for each of the Manta Ray anchors, creating a total strength of 15,000 since there are two anchors. The force that the wind creates is the same as for other designs.

The yield strength of the helix anchor has not been strength tested by the NOAA. The working yield strength is said to be 20,000 lbs (Hubbell Power Systems, 2014). Therefore, we will assume that the helix anchor can also withstand a working load of 7,500 lbs, similar to the Manta Ray anchor. We used the same equation as before

$$F_D = 15,000\text{Cos}(45^\circ) + 3,750\text{Cos}(45^\circ) + 3,750\text{Cos}(45^\circ) = 15,903.57 \text{ lbs}$$

$$15,903.57 > \frac{1}{2}\rho(v^2)C_D W_B H_B B$$

We then substituted in all of our given variables from the first two calculations.

$$10,602.38 \text{ lbs} > \frac{1}{2}(.0717 \text{ lb}_m/\text{ft}^3)(67.5 \text{ ft/s})^2(.04)(16 \text{ ft})(13.22 \text{ ft})B$$

$$B = 11 \text{ boats}$$

Therefore, the ring link design has a strength of 15,904 lbs and can support 11 boats.

Once the strength of the helix design was calculated, we then calculated the strength of the rope design. To do this, we constructed a free-body diagram of the underwater forces. Figure 83 shows the free-body diagram of forces acting upon the rope design.

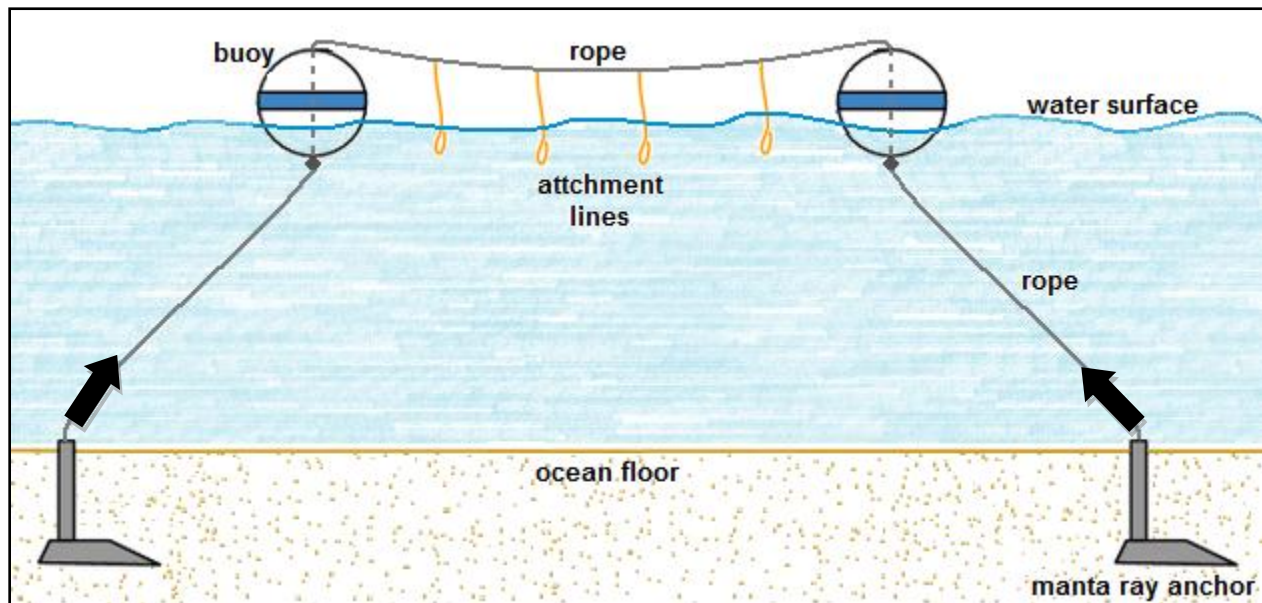

Figure 83: A free-body diagram of the underwater forces acting upon the rope design

Once again, we used a strength of 7,500 lbs for each of the Manta Ray anchors, creating a total strength of 15,000 since there are two anchors. The force that the wind creates is the same as for other designs. The equation is

$$F_D = \frac{1}{2}\rho(v^2)C_D W_B H_B B$$

Because our ideal angle between the ocean floor and the throughline is 45 degrees, we multiplied 15,000 by the Cosine of 45 degrees.

$$15,000 \cos(45^\circ) = 10,602.38 \text{ pounds}$$

We then substituted in all of our given variables from the first two calculations.

$$10,602.38 > \frac{1}{2}\rho(v^2)C_D W_B H_B B$$

$$10,602.38 \text{ lbs} > \frac{1}{2}(.0717 \text{ lbm/ft}^3)(67.5 \text{ ft/s})^2(.04)(16 \text{ ft})(13.22 \text{ ft})B$$

$$B = 7 \text{ boats}$$

Therefore, the rope design has a strength of 10,602 lbs and can support 7 boats.

Lastly, we calculated the strength of the swivel design. To do this, we constructed a free-body diagram of the forces underwater. Figure 84 shows the free-body diagram of forces acting upon the swivel design.

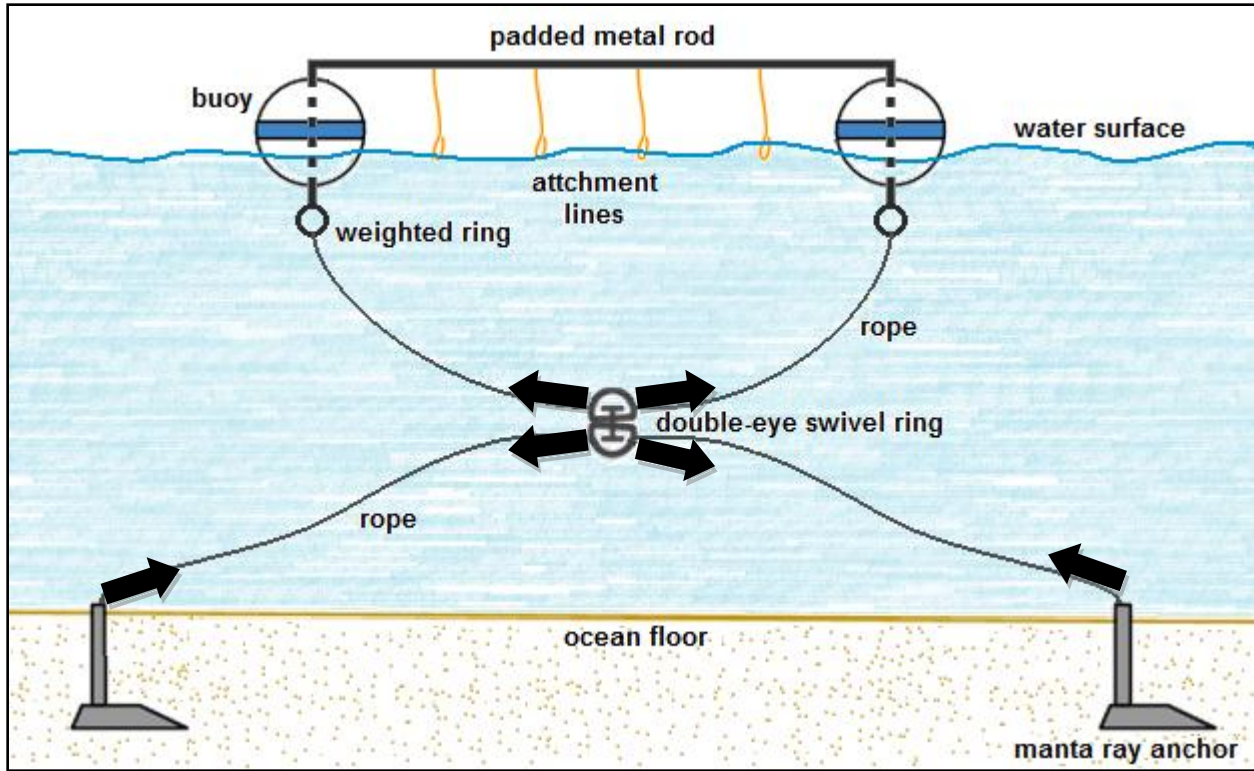

Figure 84: A free-body diagram of underwater forces acting upon the swivel design

The double-eye swivel ring and the metal rod are also made of hot-dip galvanized steel. This material has a yield strength of 40,000 psi. Therefore, the Manta Ray anchor(s) would fail before the hot-dip galvanized steel.

Once again, we used a strength of 7,500 lbs for each of the Manta Ray anchors, creating a total strength of 15,000 since there are two anchors. The force that the wind creates is the same as for other designs. The equation is

$$F_D = \frac{1}{2}\rho(v^2)C_D W_B H_B B$$

Because our ideal angle between the ocean floor and the throughline is 45 degrees, we multiplied 15,000 by the Cosine of 45 degrees.

$$15,000 \cos(45^\circ) = 10,602.38 \text{ pounds}$$

We then substituted in all of our given variables from the first two calculations.

$$10,602.38 > \frac{1}{2}\rho(v^2)C_D W_B H_B B$$

$$10,602.38 \text{ lbs} > \frac{1}{2}(.0717 \text{ lbm/ft}^3)(67.5 \text{ ft/s})^2(.04)(16 \text{ ft})(13.22 \text{ ft})B$$

$$B = 7 \text{ boats}$$

Therefore, the rope design has a strength of 10,602 lbs and can support 7 boats.

It is important to note that all of the above calculations are extremely simplified. It also very important to note that The ring link design, helix design, and the swivel design would not be efficient in shallow waters. The downline would drag too much on the ocean floor, and this would create dead zones around the mooring buoy.