

Project Number: 51-JFZ-D072

## **ENGINEERING OUTREACH TO DANISH STUDENTS**

An Interactive Qualifying Project Report  
submitted to the faculty of  
WORCESTER POLYTECHNIC INSTITUTE  
In partial fulfillment of the requirements for the  
Degree of Bachelor of Science  
by

Jeremy Lebowitz

Daniel Murphy

Erin Yokay

Date: May 8, 2007

Approved:

1. engineering
2. outreach
3. teaching

Professor John Zeugner, Advisor

## **Abstract**

Due to a recent decline in mathematics and science performance among primary school students in Denmark and waning interest in engineering, the Engineering College of Copenhagen (IHK) sponsored this project to increase engineering enrollment. The project created six short-term, high-interest, hands-on programs allowing Danish students to experience the everyday activities of engineers. Quantitative and qualitative analysis of programs revealed success at increasing engineering interest and awareness. Program materials were left with IHK for future program implementation at other Danish schools.

## **Acknowledgements**

The project team would sincerely like to thank all those who assisted in the completion of this project. First and foremost, we would like to thank our principal sponsor, Ingeniørhøjskolen i København, and our liaison, Knud Holm Hansen. They were instrumental in providing funding for the programs, an office for us to work in, and any troubleshooting along the way. We would also like to thank the four volunteers from the Export Engineering department who were invaluable in helping us along the way: Nynne Christiansen, Kresten Daugaard, Dina Mathiasen and Johanne Bach Sørensen.

We are sincerely grateful to the teachers at the two schools who allowed us to run the pilot programs in their class: Mads Petersen from Christianshavns Gymnasium, and Bodil Møller, Joergen Storm and Steen Jensen from Østerhøjskolen. Without their assistance this project would not have been as successful as it was.

We would also like to thank the LEGO Group and Mikro Værkstedet for their generous donation of five educational Mindstorms NXT kits. Aimée Crisanti, an industrial engineer from LEGO in Enfield, Connecticut was pivotal in getting us into the corporation and getting the ball rolling. We would also like to recognize Torben Jessen, an educational concept developer from LEGO, and Kristian Østergaard from Mikro Værkstedet for making it happen from the other end. They are the reason for the Mindstorms program.

To all those who put up with our relentless questioning in pursuit of background information (Yvonne Herguth from Børneuniversitetet; Thom Thomsen, director of International Studies at WPI; Martha Cyr, Director of K-12 Outreach at WPI; Henrik Bang, visiting professor from Christianshavns Gymnasium; all the IHK students who took our oral survey; Head of Development Per Velk and Pilot John Toennersen from the Experimentarium; and finally Martin Lidegaard, a member of the Danish Parliament from the Radikale Venstre party): thank you for putting up with our relentless questioning in pursuit of background information.

Finally, from WPI, we would like to thank Dean Thom Thomsen and Professor Peder Pedersen for directing the Denmark IQP site and Professor John Zeugner for advising on-site and for his patience in correcting our painfully long drafts.

## Executive Summary

In recent years, there has been a decline in Danish students' performance in standardized science tests and the number of Danish students pursuing engineering as a profession. [1, 2] As a result, schools such as the Engineering College of Copenhagen (Ingeniørhøjskolen i København, or IHK) have been experiencing declines in engineering enrollment. To facilitate a turnaround in this trend, IHK asked Worcester Polytechnic Institute (WPI) for an Interactive Qualifying Project (IQP) team to develop ways to increase interest in engineering. The main objective of this project was to develop several short-term, hands-on programs aimed at increasing Danish student interest in various engineering fields.

There is plentiful previous research in the field of engineering outreach programs [3-11] and numerous existing outreach programs affiliated with or run by WPI [4, 12]. Due to the prevalence and demonstrated success of these programs, this project focused on the development and implementation of multidisciplinary, hands-on engineering outreach programs for the Danish school system. The project was influenced in particular by "Adventure Engineering," a project undertaken by Oklahoma University to engage grade-school students in interactive real-world scenarios that require the use of engineering.

Additional background information was gathered regarding the Danish educational system to determine what grades would be most beneficial to target with engineering outreach programs, as well as to see whether an extracurricular or a class-replacement approach would be more suitable. Design of outreach programs and learning styles were also researched prior to program development. Teaching styles within the context of the Danish education system were investigated through interviews with several Danish teachers.

As a result of the wide scope of the overall goal to increase engineering interest among primary and secondary school students, the target audience of this project needed to be chosen carefully, to ensure that the quality of the programs was high and to target the student group most likely to pursue engineering because of these programs. Ultimately, after receiving the input of several Danish educators [13-15], the last two years of *folkeskole* (the Danish primary education, K-9<sup>th</sup> grade) and the first two years of

*gymnasium* (Danish secondary education, 10<sup>th</sup>-12<sup>th</sup> grade) were chosen. This choice was primarily because *folkeskole* students must choose which *gymnasium* to attend (the choices are a standard non-specialized school, a technical-oriented school, and a business-oriented school); additionally, *gymnasium* students must decide which (if any) university to attend, and in what field of study. Creative and exciting hands-on programs introducing these students to engineering may very well push them in the direction of choosing to pursue engineering in higher education.

IHK is the principal sponsor of this project; therefore, the programs were developed in fields of study that IHK offers, which are all engineering fields: building and civil, mechanical, production, electronics and computer, export, and electrical power and information technology engineering. IHK is one of two colleges in Denmark that offers export engineering, a major that blends technical fields with language and business studies; thus IHK wanted a program to highlight the field. Additionally, because Denmark is renowned for its alternative energy sources (most notably its high use of wind turbines), a program to build windmills that produce electricity was developed. The windmill program explores the fields of mechanical and electrical engineering. A program designed to explore the form and function of trebuchets, in the areas of mechanical engineering and physics, was also created. To cover the discipline of building and civil engineering, a program involving the building of structurally sound bridges was developed. These four programs were all intended for use at the *folkeskole* level, with the trebuchet and export engineering programs for eighth year students, and the bridge and windmill programs for ninth year students.

In order to introduce a more multidisciplinary program for the fields of mechanical and electrical engineering and computer science, it was more advantageous to start with a product that had already been developed. The LEGO Group, based in Billund, Denmark, was contacted regarding the use of their Mindstorms NXT kits. These kits contain motors, various sensors, and component parts to build a robot, as well as easy-to-use robot programming software. The project group was ultimately able to obtain a donation of five educational version Mindstorms kits for use in Danish schools. A hands-on program involving the building and programming of the Mindstorms robots was developed for first year *gymnasium* students.

Finally, for second year *gymnasium* students, a different program approach was taken. Rather than taking part in a hands-on program, the students are introduced to how an engineer goes through higher education and what an engineer does for a career. The program has one day where students participate in an IHK-student led experiment similar to one that might be run in a university class. The second day of the program involves contacting a local engineer to come into the classroom and discuss various aspects of engineering, such as what their company does, their day-to-day activities and how they use math and science on the job.

Once the six programs were ready for implementation, teachers from one *gymnasium* and one *folkeskole* volunteered to run the programs in their classrooms. This was primarily done to ascertain the effectiveness of these programs at increasing student interest in engineering, with a secondary benefit of being able to refine the programs based on the results. The *folkeskole* teachers chose to implement the windmill program; the *gymnasium* teacher implemented the LEGO Mindstorms program with his first year class and hosted an engineer from Mærsk with his second year class. Surveys were given to each class before and after testing to gauge the influence of the programs on several factors, including student perception of the value of math and science, and knowledge and propensity for engineering.

Results from the survey were highly encouraging. Figure 0.1 shows the effect of the programs on both *gymnasium* (G) and *folkeskole* (F) classes. Students were asked to respond on a scale of 1-5 (with 1 being strongly disagree and 5 being strongly agree) how they agreed with certain statements regarding math, science and engineering both before and after experiencing the program. Figure 0.1 shows the statements with the largest increases in averaged response, which occurred with “learning math and science is fun” (2), “I know what an engineer does” (5), “I could be a successful engineer (6), “engineering is enjoyable” (7), and “I would be successful in a job that required math or science” (10).

With feedback from students and teachers, and observations from the project team, the programs were modified to be more effective and easier to administer in the future. The final design of each program was such that it could be run by an otherwise untrained teacher with no further instruction. Each of the six programs has a teacher’s

**Changes in Response Averages  
due to Program Implementation,  
Gymnasium and Folkeskole**

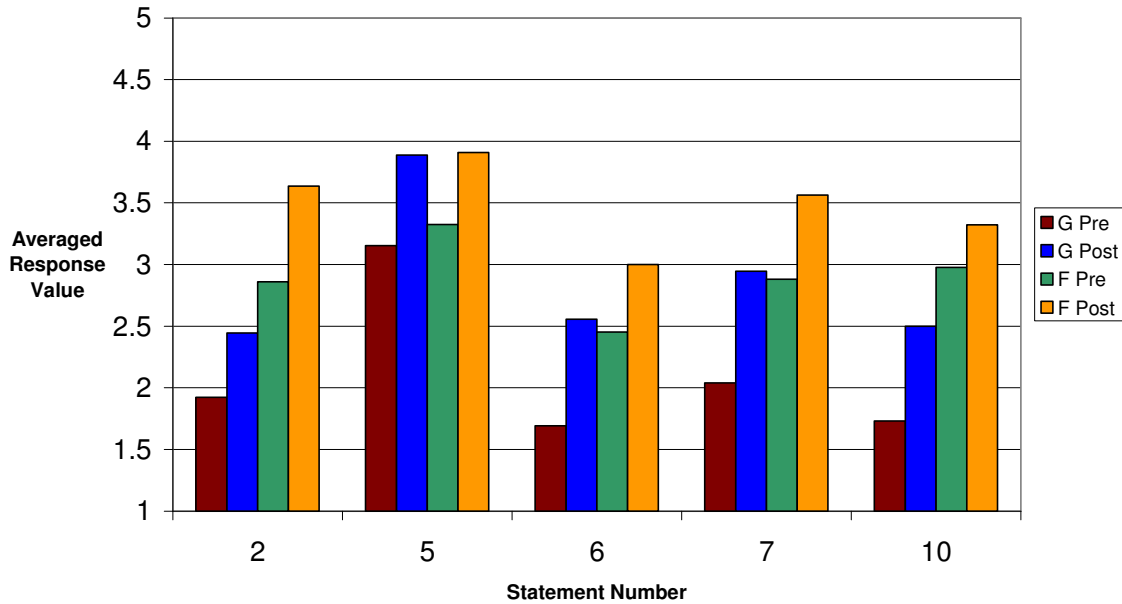

**Figure 0.1:** Program implementation effect on *gymnasium* and *folkeskole* students.

manual which includes preparation for the program, a list of required parts and their approximate cost, a time breakdown for each subsection of the program, and detailed information regarding the appropriate engineering disciplines. Any handouts for students are also provided. All handouts are located in Appendices 13 through 18 of this report. This material is currently available online at the project team’s website, and has also been provided to IHK digitally for distribution on their website. Some programs required a more expensive or difficult to procure component (e.g. the Mindstorms kits or a working trebuchet); these components are being stored at IHK for any teachers wishing to run the programs in their class in the future.

At the conclusion of the project, a “Program Presentation Fair” was held at IHK to raise awareness for teachers who might be interested in running the programs with their class in the future. Unfortunately, due to timing issues, only some students and their parents were able to attend the fair. However, several teachers, including the ones who hosted programs while the project team was on-site, have already pledged to run the programs with their classes in future years.

Despite the setback of not being able to implement all six programs, it is clear that the ones that were implemented still achieved their goal of increasing student interest in engineering. The programs have all started gaining popularity among local teachers, and hopefully this trend will continue. IHK was very pleased with the results and expects to continue distribution and implementation of the programs in autumn of 2007 and beyond.



## Table of Contents

<b>ABSTRACT</b>	<b>I</b>
<b>ACKNOWLEDGEMENTS</b>	<b>II</b>
<b>EXECUTIVE SUMMARY</b>	<b>III</b>
<b>TABLE OF CONTENTS</b>	<b>VIII</b>
<b>TABLE OF FIGURES</b>	<b>X</b>
<b>1. INTRODUCTION</b>	<b>1</b>
<b>2. BACKGROUND</b>	<b>2</b>
<b>2.1. PREVIOUS RESEARCH (WPI)</b>	<b>2</b>
2.1.1. OUTREACH PROGRAMS (WPI)	4
<b>2.2. PREVIOUS RESEARCH (OTHER SCHOOLS)</b>	<b>5</b>
<b>2.3. DANISH EDUCATION SYSTEM</b>	<b>7</b>
2.3.1. DANISH ENGINEERING EDUCATION	11
<b>2.4. OUTREACH PROGRAM DESIGN</b>	<b>12</b>
2.4.1. PROGRAM LEARNING STYLES	13
2.4.2. ENGINEERING LEARNING STYLES	14
2.4.3. TEACHING TECHNIQUES	15
2.4.4. INPUT FROM DANISH EDUCATORS	18
<b>2.5. IHK HISTORY AND INVOLVEMENT</b>	<b>19</b>
<b>2.6. LEGO HISTORY AND INVOLVEMENT</b>	<b>20</b>
<b>3. METHODOLOGY</b>	<b>22</b>
<b>3.1. TARGET AGE GROUP SELECTION</b>	<b>22</b>
<b>3.2. INITIAL ON-SITE INTERVIEWS</b>	<b>22</b>
<b>3.3. PROGRAM DESIGN</b>	<b>24</b>
<b>3.4. PROJECT BUDGET</b>	<b>26</b>
<b>3.5. PROGRAM TESTING</b>	<b>27</b>
<b>3.6. ANALYZING OUTCOMES</b>	<b>27</b>
<b>4. RESULTS &amp; ANALYSIS</b>	<b>29</b>
<b>4.1. HANDS-ON ENGINEERING PROGRAMS</b>	<b>29</b>
4.1.1. TREBUCHET PROGRAM	29
4.1.2. WINDMILL PROGRAM	30
4.1.3. BRIDGE PROGRAM	31

4.1.4.	EXPORT ENGINEERING PROGRAM	32
4.1.5.	LEGO MINDSTORMS PROGRAM	33
4.1.6.	“EXPERIENCE ENGINEERING” PROGRAM	34
4.2.	PROGRAM IMPLEMENTATION	35
4.3.	SURVEY RESULTS	38
4.4.	DANISH MOTIVATIONS FOR ENGINEERING	41
4.5.	PROGRAM CONTINUATION	42
<b>5.</b>	<b><u>CONCLUSIONS &amp; RECOMMENDATIONS</u></b>	<b>43</b>
<b>6.</b>	<b><u>APPENDICES</u></b>	<b>46</b>
6.1.	LEARNING STYLE CATEGORIES	46
6.2.	SURVEY/FOCUS GROUP DISCUSSION QUESTIONS	47
6.3.	SURVEY FOR FOLKESKOLE/GYMNASIUM PROGRAM PARTICIPANTS	48
6.4.	INTERVIEW WITH MARTHA CYR, 1 FEBRUARY 2007	49
6.5.	INTERVIEW WITH HENRIK BANG, 8 FEBRUARY 2007	51
6.6.	INTERVIEW WITH THOM THOMSEN, 25 JANUARY 2007	53
6.7.	E-MAIL CORRESPONDENCE WITH KNUD HANSEN, C TERM 2007	54
6.8.	INTERVIEW WITH YVONNE HERGUTH, 21 MARCH 2007	63
6.9.	INTERVIEWS WITH IHK STUDENTS, MARCH 2007	65
6.10.	INTERVIEW WITH EXPERIMENTARIUM EMPLOYEES, 26 MARCH 2007	69
6.11.	IQP TEAM MEMBER PROGRAM JOURNALS, 13-24 APRIL 2007	71
6.12.	INTERVIEW WITH MARTIN LIDEGAARD, 14 MARCH 2007	73
6.13.	PROGRAM MATERIALS: TREBUCHET PROGRAM	74
6.14.	PROGRAM MATERIALS: WINDMILL PROGRAM	84
6.15.	PROGRAM MATERIALS: BRIDGE PROGRAM	95
6.16.	PROGRAM MATERIALS: EXPORT ENGINEERING PROGRAM	116
6.17.	PROGRAM MATERIALS: LEGO MINDSTORMS PROGRAM	135
6.18.	PROGRAM MATERIALS: EXPERIENCE ENGINEERING PROGRAM	150
6.19.	QUANTITATIVE SURVEY RESULTS	153
6.20.	PROGRAM IMPLEMENTATION PHOTOGRAPHS	156
<b>7.</b>	<b><u>BIBLIOGRAPHY</u></b>	<b>160</b>

## Table of Figures

FIGURE 0.1: PROGRAM IMPLEMENTATION EFFECT ON <i>GYMNASIUM</i> AND <i>FOLKESKOLE</i> STUDENTS. ....	VI
FIGURE 3.1: METHODOLOGY FLOW CHART FOR ON-SITE WORK.....	22
FIGURE 3.2: PROPOSED PROGRAM BREAKDOWN BY GRADE LEVEL. ....	26
FIGURE 4.1: PROGRAM IMPLEMENTATION EFFECT ON <i>GYMNASIUM</i> STUDENTS. ....	39
FIGURE 4.2: PROGRAM IMPLEMENTATION EFFECT ON <i>FOLKESKOLE</i> STUDENTS.....	40

## **1. Introduction**

Ingeniørhøjskolen i København (IHK), or the Engineering College of Copenhagen, has seen a decline in students choosing to go into engineering as a profession. IHK has asked our project team to investigate possible ways of increasing enrollment in engineering programs. After assessing prior efforts through similar Interactive Qualifying Projects (IQPs) at Worcester Polytechnic Institute (WPI) and other universities in the United States, we intend to achieve this objective by creating and disseminating interest-generating hands-on programs. These programs are tied to curriculum, designed for students aged 13-17, represent various (and multiple) engineering disciplines, and can be repeated in subsequent years in Denmark.

Because of the Danish educational structure, students generally must decide what field to pursue by the time they are 16 years old. Thus, initiatives to introduce Danish students to engineering must be undertaken at an earlier age if they are to be effective. Previous research has indicated that interactive programs are much more effective at maintaining interest and encouraging inquiry than are passive lectures. [11, 16, 17] Thus, our project is focused on designing age-appropriate, engaging, hands-on activities and packaging them for implementation by otherwise untrained mentors. Our goal is to leave behind easy-to-read and comprehensive manuals, complete with kits of parts, so that in future years the activities can be run in Denmark with no further outside assistance required.

Results obtained from this project include subjective analysis of the programs from participants of the program (both students and mentors) and observations by project team members during implementation of the programs. A survey (found in Appendix 3) was also administered to participating students before and after the project in order to more objectively measure the program results in terms of an increase in engineering interest. All of the evaluations were used to modify the program manuals before leaving the project site.

## **2. Background**

This section details research related to this project in a variety of fields. First, previous findings from IQPs with similar goals and their applicability to this IQP are examined, followed by existing outreach programs at WPI. Then, efforts at other schools are investigated. A fundamental understanding of the Danish school system and infrastructure are necessary for the successful implementation of any outreach programs. These were enhanced by on-site interviews with various individuals involved with some part of the Danish educational system. Also, knowledge of engineering learning styles is necessary to ensure that basic concepts are grasped and understood as part of this IQP's outreach programs. An explanation of why the targeted age group was selected is provided. A brief history of the Engineering College of Copenhagen and their interest in this project is given, followed lastly by a similar section for the LEGO Corporation.

### ***2.1. Previous Research (WPI)***

In the endeavor to bring the excitement of science and engineering to Danish schools, initial efforts involved finding previous research done in similar fields at WPI. Several Interactive Qualifying Projects have been completed in recent years that involved engineering outreach to area elementary, middle and high schools. Although many of these projects were focused on one particular field, or had a different overall goal from this project, several useful features of programs developed by other IQP teams can be applied to this project.

In "Developing a Robotics Outreach Program," [3] WPI students utilized LEGO Mindstorms kits to develop a relatively inexpensive robotics tournament for area high school students. Enlisting the help of teachers as team mentors, the IQP team taught high school students to build and program the robots in four weeks for a competition the IQP team designed. Although the current project is geared more towards noncompetitive learning, several key features of the Robotics Outreach Program were relevant. For example, their IQP team kept detailed journals of their interactions with students and teachers in order to accurately portray methods that were either effective or unsuccessful. They also found that when giving the teachers/mentors a primer in the applicable subject

matter, it was better to assume teachers had minimal background knowledge, given the differing technical backgrounds of the WPI students and the high school teachers. Another key feature of their project was the use of programming “cheat sheets” for use by students. These allowed for increased independence of high school students and required less involvement on the part of the IQP team. One final important note from the report was that any files used in conjunction with the program were converted to PDF format to guarantee compatibility across platforms and varying degrees of accessibility.

Another IQP focused on younger students. The author of “LEGO Robotics in Elementary Education” [18] developed an extracurricular program for elementary school students, also using LEGO Mindstorms kits, to foster an engineering mentality. The project is more similar to the current one in that it is not competitive in nature, and focuses on a “learning-by-making” approach. [18] The “Elementary Education” IQP dealt heavily with the different learning styles of students (kinesthetic, visual, auditory, interpersonal and intrapersonal) and therefore the project was suited for all learning styles. Two important features of the report were the use of colored instructions for activities in order to promote ease of use, and the presence of alternative activities for uninterested or rowdy students, (which were no more interesting or involving than the main project program in order to discourage other students from becoming disengaged from their own projects).

Another IQP focused on modifying an existing outreach program. “Design of a Robotics Workshop for Camp REACH” [4] aimed to create a robotics program that could be implemented into Camp REACH, a WPI-run summer camp for middle school-aged girls. The IQP designed the program, and investigated the feasibility of its integration into the existing camp infrastructure, with the assistance of previous graduates of the program. Two major points that emerged from the IQP team’s interview with camp staff member Amy Adams were that girls preferred workshops that included a demonstration or exciting example of principles the students would be investigating, and that a successful program had easily obtainable experimental results when the workshop was done carefully and completely. [4] This project will be implementing the demonstration aspect of the Camp REACH project in order to encourage student enthusiasm about the programs and also to increase teacher familiarity with the subject.

### **2.1.1. Outreach Programs (WPI)**

Several outreach programs have already been developed at WPI, spanning a wide age group. Since WPI has always been focused on technology, science and engineering, it follows that the school supports many outreach programs. Perhaps the most prominent of these programs is the Massachusetts Academy of Math and Science, a public high school tailored to juniors and seniors with an interest in engineering. Seniors in the Academy actually take first-year courses at WPI; this is facilitated by the proximity of the two schools.

There are many other programs that cater to middle school-aged students. Three of the outreach programs that are most relevant to this project are Intellect Quest, Camp REACH, and the Kids to College Program. Intellect Quest is a six day summer program for students in fifth to eighth grade that engages students with “lots of science, math, robotics, and art.” [12] Camp REACH is a two week summer program designed for girls entering seventh grade. The camp has been the focus of numerous other Interactive Qualifying Projects, from the one that proposed its creation to others investigating the feasibility of certain projects for use at the camp. The Kids to College Program is a six session seminar for minority sixth grade students, designed to introduce them to the college setting. The most appropriate portions of each of these programs were applied to this project in a similar manner as previously completed IQPs.

We interviewed Martha Cyr, the director of K-12 Outreach at WPI, for further explanation of the K-12 outreach programs. She related some of the findings of her experience that were useful for this project. (Notes from the interview are detailed in Appendix 4.) She noted that especially for girls, the decision whether to become an engineer has generally been made by the time a student has passed the fourth grade. [19] She suggested that we research the local Danish educational standards and try to develop projects for learning that fell under those criteria. [19] She also referred us to prefabricated lesson plans that were already in use among outreach programs nationwide, produced by the International Technology Education Association. [19] She recommended that for training mentors for a program, the most important principle to follow was that student self-discovery is the highest-impact form of learning; any mentor assistance should be provided in a manner that steers students toward a suitable solution without

simply providing them with an answer. [19] She also suggested that the mentors should go through the program themselves to determine where they might have questions, but mostly to see how the students will be learning. [19]

The main outcome of the interview with Ms. Cyr was the awareness of these prefabricated learning modules. Although the intent of this project was still to create original modules, viewing pre-developed ones on similar topics helped to ensure that all necessary facets of a successful project were covered.

## ***2.2.Previous Research (Other Schools)***

Of course, research of this nature is not restricted to WPI. Several other universities have undertaken similar efforts. Perhaps most similar to this project is the case of Oklahoma University's "Adventure Engineering." [5] This initiative is designed to directly replace science and/or math classes for students in grades 5 to 9, and is based on several brief scenarios that encourage students to creatively engineer solutions. One such example involves an asteroid collision with earth, where students must design cavernous shelters for a given population based on geological maps and hands-on testing of various rocks. This design is ideal because it requires very little in terms of resources and funding, yet still encourages a great degree of hands-on engineering and brainstorming. Adventure Engineering (AE) specified that "once the scenario, obstacles and activities have been developed, the AE team prepares a teacher's guide designed to lead a teacher with no prior engineering experience and with no help from AE team members through the implementation of the curricula." [5] This situation is optimal because it allows for the introduction of engineering principles in a format the teacher or mentor can understand, even if the research team is not on site to provide support; it would be ideal for this project to follow many of the guidelines set by Adventure Engineering since one of its primary goals is future implementation following May 2007.

Several objectives were outlined in the Adventure Engineering paper that contributed to the objectives of this project. The AE paper stated that "the program of study in science for all students should be developmentally appropriate, interesting, relevant to students' lives, should emphasize student understanding through inquiry, and be connected with other school subjects." [5] This IQP will similarly be targeted at



relevant interests of students. Similarly to AE, this IQP's "activities are designed to facilitate concept understanding and immerse students in the engineering design experience." [5] The main difference between the two initiatives is that AE was designed to be implemented into American schools' existing science and math curricula, due to the infrastructure already in place. It is logistically more difficult to launch a similar extracurricular activity without introducing bias: by implementing the AE curriculum as part of the regular school day, each student is required (or given the opportunity) to participate in this experience; this format results in equal exposure regardless of gender, race or economic status, factors which otherwise might affect attendance at an after-school activity. In Denmark, extracurricular activities are much less common than in the United States due to pre-existing activities during that timeframe. As a result, and with the recommendation of several advisors [13-15], this project was implemented during the school day as a direct replacement to some classes. Danish curricular structure is examined further in section 2.3.

Perhaps the most useful feature of the Adventure Engineering report was the use of surveys to quantify the success of the program. AE's survey provided a model for this project, as it covers many necessary topics and useful conclusions can be drawn from the data. The survey is designed to be administered both before and after student participation in the program; by asking the same questions both times, a direct link can be made as to the success of the program. A complete list of the survey questions used in this project can be found in Appendix 3. Results from the survey are tabulated in Appendix 19 and discussed in Section 4.3.

Another outreach program of interest was launched over 30 years ago by the University of Wisconsin at Milwaukee. The Gateway to Engineering, Science and Technology (GEST) Program is geared toward middle and high school students from underrepresented groups. [6] The GEST Program uses "academic enrichment and reinforcement activities for talented students as well as those interested in seeing what these career paths have to offer." [6] A key feature of the program that this project could utilize was "science and technology expositions and fairs" that "enable the students to receive recognition for their accomplishments." [6] Having a portion of the program dedicated to showcasing the efforts of students is beneficial for several reasons. First,

Danish students will have some recognition for all the hard work they put into the project; perhaps parents will also be able to see the results of their child's hard work. Additionally, some students might not be particularly interested in the activities afforded by the given projects; these students could develop posters or another means of presentation for the product created by the students. Finally, an exhibition of the programs held outside of normal school hours could potentially attract teachers, students and parents not participating in the program during its initial run; this exhibition could then serve as a catalyst in spreading the program to other schools in future years.

A project undertaken by Iowa State University was aimed at the opposite end of the spectrum: it focused on increasing the technical literacy of college students majoring in primary and secondary education. [20] The goal of the project, "An Engineering Linkage to K-12 Teachers," was to "explain the principles behind many of the technological innovations in wide use today via a collection of hands-on laboratory experiences based upon simple systems constructed out of LEGOs and controlled by small computers." [20] The program utilized the LEGO Mindstorms kits to increase the quality of the program without significantly increasing the cost. Overall, the university professors involved with the development of the program were satisfied with the degree of interactivity the Mindstorms kit offered. The ease of use experienced by the education students was an important reason why this project considered the use of Mindstorms kits. A more thorough description of the Mindstorms program is in Section 4.1.5; an evaluation of the effectiveness of the Mindstorms program can be found in Sections 4.2 and 4.3.

### ***2.3. Danish Education System***

The Danish education system is a three-tiered program that is funded entirely by the state for the benefit of all Danish citizens. The first level is referred to as *folkeskole*, or alternatively, "basic education." This level is required for all children, starting at age seven and continuing for nine years. There are two optional years available in addition to the required portion, one offered before and one offered after the normal time period. [1]

The next level of education is upper secondary school, which allows students to begin specialization in fields of study that interest them. The *gymnasium*, *højere*

*forberedelseksamen*, *højere handelseksamen* and *højere tekniskeksamen* are all part of the upper secondary education program, which prepares students for progression to higher education. [21] *Gymnasium* provides an unspecialized general academic program. *Højere forberedelseksamen* is much like *gymnasium*, but is intended for students who completed the optional tenth year of the *folkeskole* and thus is only two years long. [1] The *højere handelseksamen* is a three-year high school that provides a specialized program intended to prepare students for work in business. [1] *Højere tekniskeksamen* is also a three year program, designed to provide technical education above and beyond the general academic curriculum. In addition to traditional schools, the Danish upper secondary education system offers a strong vocational program for those students less inclined towards academia. These schools have programs of comparable length to other secondary schools, but focus on direct training in job skills, with other subjects available as options. [1]

The highest tier of the system is simply called “higher education” and encompasses a wide variety of programs to prepare students for their careers. Professional academies are the shortest higher education programs; they provide two years of advanced training in technology and business with a few months of project work to conclude studies. [22] Medium-cycle programs are designed to provide a bachelor’s degree in one or two subjects within three years. [22] Finally, the long-cycle education programs extend two or more years beyond a bachelor’s degree. These programs award advanced degrees after extended periods of study. Such a program is necessary for a medical degree, and is highly recommended for those students who are interested in science-based careers.

It is important to note that only nine years of basic education are in fact mandatory. With this legal requirement, many Danish students choose not to pursue education beyond the mandatory period. From 1994 to 2001, attendance of general upper secondary education decreased by a total of 9.2% while, during the same time, there was no significant change in attendance of vocational upper secondary education. [2] At this point in the decline, experts expected only 55% of students to enter into a general (rather than vocational) upper secondary program. [2] From these enrollment rates, it is easy to

conclude that some combination of factors is deterring Danish students from pursuing academics beyond the bare minimum requirements of the state.

In recent years, the average age of students in upper secondary and higher education has increased, because more students each year choose to take a break from their studies and return at a later time. [2, 23] Although not directly disadvantageous, this delay along with the late starting age of the Danish education system causes the Danish workforce to be older than in similar countries. [2] This break can also lead to a delay in when students choose a field to study further. Many IHK students interviewed had not decided to go into engineering fields until a few months prior to starting studies at IHK. [23]

The overall decrease in interest among students is affecting all programs, but science and engineering disciplines are suffering more than others. Students are performing poorly and choosing to pursue other subjects, if they do advance beyond basic education at all. An example of this is given by the PISA test. The PISA is a standardized test that is administered internationally, to assess the relative aptitude for language, math and science of 15-year-old students around the world. [24] Danish students achieved approximately average scores overall and above average scores in mathematics, but on a science test with an international average score of 500, Danish students received only 481 points. [25] The Danish Ministry of Education considers these scores to be indicative of a generally inadequate science education program in the basic school system. [26] Additionally, administrators and faculty at both the Engineering College of Copenhagen and the Danish Academy of Technical Science have expressed concern as to the quantity and quality of applicants. [27] These institutions have experienced a measurable decrease in the number of academically acceptable students who wish to primarily pursue an education in science or engineering. [2]

Different Danish institutions have attempted to institute programs capable of reinvigorating student interest in technical fields. In 1993 an act went into effect that required science education in years one through six of *Folkeskole*. This program was well-received by teachers, students and parents, but both the Academy of Technical Science and the Ministry of Education found that teachers often lacked sufficient knowledge of the subject matter for fully effective teaching. [26, 27] In order to facilitate

the process, the Ministry of Education has continually supported both the development of advanced teaching aids which incorporate technology into the classroom, and programs continuing the education of teachers while they work. [27] The program for development of teaching aids was first proposed in 1994, but there is little data on its success, and it has since been integrated into the broader “Better Education” program which began in 2002. [24, 28] The currently available compiled and presented data extends only one year into the most recent program and provides little insight into the value of the programs. Introducing the product of this project to universities that train students to become teachers could be a very popular way to fulfill the continuing education programs already in Denmark. [15] Currently, a large drawback to the implementation of the programs this project proposes is the rigidity of the curriculum in that a certain amount of teaching hours are allotted by subject area. To implement the programs during class time, the time must be docked from other relevant subjects. [15] This is an important factor to consider in designing programs for curricular implementation.

To supplement data gathered from written sources, our group interviewed Henrik Bang, a Danish *gymnasium* teacher who is currently spending a year teaching in the United States. He was able to supply us with a unique insight into the attitudes and abilities common in Danish schools. He was also able to comment specifically on aspects of our existing plans that he believed would succeed when attempted in Denmark. [13]

Mr. Bang made it a point to stress the differences between the basic and upper secondary education systems. He described a dramatic change in academic rigor and general mood upon transition out of *folkeskole*. The *folkeskole* classes are not divided according to ability or interest and are instead designed to accommodate all students. Because of this method, no field of study at a *folkeskole* can progress beyond the capabilities of the least talented or least motivated students. He suggested therefore, that we should expect to encounter relatively poor training in fields of mathematics beyond arithmetic. [13] To ensure the greatest level of comprehension, our programs for *folkeskole* would have to be carefully tailored to avoid algebra while still presenting fundamental scientific concepts.

In contrast to the *folkeskole*, the *gymnasium* is an academically rigorous institution, which serves students who have chosen to continue their education. Mr. Bang

explained that within their three years at a *gymnasium*, students learn more advanced mathematics, up to and including calculus. [13] He felt that with such a rapid, intensive program, it was reasonable to expect students nearing the end of their first year to have sufficient mathematical skills to perform calculations required for introductory science and engineering concepts.

Mr. Bang also discussed with us the time limitations of both students and teachers. In *folkeskoler* the teachers are expected to spend the majority of their time teaching and to use what little time is left to prepare lesson plans. He believed that most of these teachers would be grateful for prepared lessons and student activities (especially for science and engineering, in which only a small portion of *folkeskole* teachers are well trained). Mr. Bang also felt that the matters of time and training were less likely to be a concern among *gymnasium* teachers, but few were likely to reject our offer of assistance. The only time during which outside projects would be a burden is the final year of *gymnasium*. At this level, students are likely to be busy visiting prospective colleges and preparing for their final exams, which determine placement at colleges. [13]

There were a few matters of attitude and perception that also needed consideration. As mentioned before, the *folkeskoler* foster an open environment, while *gymnasier* are much more focused. There is some concern that while *folkeskole* students will see projects as a normal part of the curriculum, those at a *gymnasium* will perceive the temporary change as a departure from real work and be less concerned with truly incorporating concepts into their working knowledge. Programs at *gymnasier* could require more work towards increasing the mentality of engineering as a profession rather than trying to teach the subject. Other common aspects of Danish education for consideration were an increased emphasis on group work and avoiding extensive lecturing.

### **2.3.1. Danish Engineering Education**

After brief interviews with several Danish engineering students at IHK, it was discovered that many engineering students don't even choose to go into engineering until as late as the year before they start attending university. [23] Many students take this year off from school to travel. The vast majority of interviewed students said they would like

to see more efforts to include engineering in primary education. [23] However, this desire is countered by a general lack of time in classes for additional science courses. [29] Another trend discovered was that there are few programs to introduce students to engineering at school; many engineering students only knew about the field because at least one parent was an engineer. [23] Fortunately for this project, the situation leaves much room for improvement regarding adding engineering curriculum to Danish lower-level classrooms.

#### ***2.4. Outreach Program Design***

Although children have a tendency to be drawn toward engineering at a young age, this desire is seldom developed. In general there is little focus on cultivating interest towards science and math at an early age. Recently there has been a movement concentrating on childhood understanding of technology. If children are aware of how things around them work and are developed, they are more likely to be inclined to go toward a technological field. Increasing and improving science and mathematics education in K-12 students is the only way to prepare them for studying engineering in college. [30] However, a good education isn't enough. Programs are needed to "develop their engineering intuition and learn to use this new engineering perspective." [31] There are two main reasons that experts believe interest in engineering is declining: a "limited understanding of the profession and loss of interest in math and science." [7] Young students not only need to increase their knowledge of engineering, they need to be inspired.

Blame is currently placed on lower level schools for the decreasing numbers in university engineering enrollment. Curriculum needs to be revamped to bring math and science to the forefront, but that is not the total solution. Many teachers feel uncomfortable teaching engineering concepts. Unfamiliar with the material themselves, they do not want the responsibility of introducing it to their students. If classrooms and school programs are to advance in this field, a new group of educators need to be looked at: current and future scientists. [32] Having a specific focus in science and engineering, professors and college students are the ideal educators for developing young engineers-to-be. They have the interest and the skills to become dynamic instructors.

Outreach programs are an ideal way of incorporating professors and college students into a student's learning process. These programs come in many different styles, either incorporated into the curriculum or as an after-school activity. The main objective of engineering outreach programs is to infuse a child's regular education with a science and technology education they may not otherwise receive. This process involves engaging students and showing them a new world of learning. Outreach programs not only help children "learn to analyze technologies and develop, build and test their own design," [8] but they also excite the children about what they are doing, engaging teaching methods. There are a variety of benefits that come from these programs. Making math and science more approachable makes students more likely to take advanced courses in the future, thus increasing the "pool of potential engineers." [9, 10]

Making the connection between a classroom activity and reality is vital, as "children lose interest in science and math when they do not see the connection to the real world around them." [7] By incorporating outreach programs within the curriculum, children are able to learn in a new way. Instead of thinking their lessons will be useless to them in the future; students can see real world tie-ins. "It is not enough to read about engineering in a book. The students must be actively engaged in questions, in observation, in prediction, in experimentation, and in design." [16]

#### **2.4.1. Program Learning Styles**

Giving students hands-on experience is a key way of keeping their attention. If a child is more involved in the learning process, they will appreciate it more. "By nature, engineering is a hands-on field;" [11] if students never see anything outside of a textbook they will not understand how exciting a technical field can be. By actually experiencing the actions and reactions of an experiment, students can "feel the underlying physics." [11] Hands-on experiments are educational and should be fun. These interactive activities "result in children not even realizing that they are gaining valuable knowledge and skills." [17] There are many resources available that give ready-made in-class procedures introducing a wide range of scientific concepts with a high "wow" factor, which make it easy for educators to incorporate what they want to convey in an exciting manner.



Sometimes recreating an existing experiment isn't enough. By incorporating the students into the entire process they can grasp what an engineer does. Problem-solving is a major part of engineering and is an easy concept to introduce to children; it emphasizes the importance of an engineer, showing how many conveniences exist because of someone in this field. Letting students ask their own questions increases their interest and relates science and math to their own life. "Activities that emphasize observation and exploration through experimentation can facilitate this inquiry." [16] This idea builds on the hands-on approach, linking observation and exploration.

#### **2.4.2. Engineering Learning Styles**

While better teaching techniques can reach students in a new light, there are even more ways to break down boundaries. Being attuned to how a child learns is a necessity for any educator. Since outreach programs are not necessarily taught by educators familiar with a particular age group or with teaching at all, emphasis must be placed on appropriate teaching methods. The educators must "be aware of the different learning needs and capabilities of students when targeting classroom materials to specific age groups." [7] A significant amount of research in this field has improved the overall learning experience. According to a study by the American Society for Engineering Education there are four different types of learners: innovative, analytical, common-sense and dynamic. [33] There are very specific traits that each style exhibits (see Appendix 1 for more detail). A large portion of this project is ensuring that aspects of each program appeal to all four learning styles in order to engage every student.

Teachers and mentors are often the biggest influences in a child's life. If one of these mentors is an engineering student, the child could have a different view of the engineering process. The younger student would then have someone to look up to and a career to strive for. Undergraduate participation in outreach programs adds the benefit of directly impacting younger students. [34] Role models can contribute just as much to the growth of a child as the educational portion of an outreach program.

Outreach programs can be implemented in a few locations. Two effective methods involve taking students to a university, or taking the program to the participating school. Allowing students to experience a new way of learning in a new

environment is a very powerful approach. Being at a university would “introduce K-12 students to state-of-the-art technology and real-life engineers while giving them a glimpse of campus life.” [7] On the other hand, “taking engineering outreach materials to the K-12 schools is possibly the quickest and most efficient way to reach a large number of K-12 students and introduce them to the field of engineering.” [7] Ultimately, both systems can be very effective so long as each involves participation from both students and educators.

### 2.4.3. Teaching Techniques

It is very important that a student knows exactly what to expect out of a course. Especially in engineering education, there must be structure for students to maintain interest and participation. Introducing instructional objectives at the beginning of a lesson shows students what they will be learning and how they are expected to demonstrate the knowledge they have acquired. Instructional objectives “contain a stem specifying the point at which the mastery should occur, followed by one or more phrases describing the expected behavior, with each phrase beginning with an action verb.” [35]

#### Example Instructional Objectives:

*When this chapter has been completed, the student should be able to define the variables in the ideal gas equation of state in terms a high school senior could understand, calculate the value of any one of the variables from given values of the other three, estimate the error in the calculated value, and outline the derivation of the ideal gas equation from the kinetic theory of gases.*

#### Example Common Stem Statements:

- *When this chapter has been completed...*
- *In order to do well on the next test...[35]*

The most effective verbs are very specific (e.g. predict, list, design, identify). Vague verbs such as “know” or “understand” could lead to further questioning from the students; students might wonder how to demonstrate understanding of the material.

Instructional objectives can cover many levels of the learning process. Learning can be defined as a hierarchy consisting of six levels;

1. **Knowledge**—repeating memorized information
2. **Comprehension**—paraphrasing text, explaining concepts in jargon-free terms
3. **Application**—applying course material to solve straightforward problems

4. **Analysis**—*solving complex problems, developing process models and simulations, troubleshooting equipment and system problems*
5. **Synthesis**—*designing experiments, devices, processes, and products*
6. **Evaluation**—*choosing from among alternatives and justifying the choice, optimizing processes, making judgments about the environmental impact on engineering decisions, resolving ethical dilemmas* [36]

Knowledge, comprehension and application are considered lower-level skills that are used to introduce a topic and allow students to become comfortable with the material. Analysis, synthesis and evaluation are considered higher-level skills that are developed after basic skills are mastered.

While introducing a new topic, teachers often do not explain why the subject matter is important, and how it can one day be useful. With this approach, educators expect their students to believe they will eventually understand why they had to learn the material. This method is called the “Trust Me” approach. [35] Even when word problems are introduced, they do not relate to the students life. A more successful approach is putting each new lesson in context, including real-life examples that could be provided by students.

Example Approach:

*For the next two weeks we’re going to be discussing characteristics of a fluid flowing through a pipe. In groups of three, come up with as many situations as you can that involve this subject—three people talking, one writing down the ideas. You have one minute—go!* [35]

After students are aware of the applicability of a new topic, they can be given a real-world problem to solve.

Real World Problem Solving:

*OK, you’re now engineers designing a piping system to move fluid from a storage tank to a reactor at a specified rate. What will you need to know or figure out? Same groups, two minutes—go!* [35]

This approach increases interest in the classroom and introduces students to future career possibilities.

Engineering courses rely on both concrete and abstract information. Concrete information includes facts, observations, experimental data, and applications. [35] Abstract information is very different, focusing on concepts, theories, mathematical formulas and models. [35] Both categories are essential to an engineering education but it

can be difficult to strike a balance within a lesson plan. A popular approach is called “teaching around the cycle,” [35] which begins with a concrete experiment, documenting observations, creating an abstract model, experimenting, and testing the model. Interrelation of concrete and abstract areas is very important. Students must be able to understand how theory works in real life. If the class is not experiment-based, it is imperative to ensure concrete information is not forgotten. All topics must be interrelated rather than compartmentalized in the educational process, to facilitate student understanding. This method can be implemented by explaining a theoretical concept, then providing a visual of how it really works. The lesson must be tied to reality if it is to have any effect.

In the traditional classroom setting, a teacher stands in front of the students and lectures. “Research indicates that this mode of instruction can be effective for presenting large bodies of factual information that can be memorized and recalled in the short term.”[35] However, this method is not particularly useful for teaching the complexities inherent in engineering concepts. To break the monotony and increase retention of the subject matter, students could work together on projects or even simple problems. Hands-on activities reach out to all types of learning styles. Active learning encourages student involvement and cooperation. Teamwork benefits students in many subject areas and is a desired skill in the workplace.

To maximize the benefits of cooperative learning, a teacher must split the approach into five main parts: positive independence, individual accountability, face-to-face promotive interaction, appropriate use of interpersonal and teamwork skills and regular self-assessment of team function.

#### Aspects of Cooperative Learning

1. **Positive independence.** There must be a clearly defined group goal (e.g. complete the problem set, write the lab report, design the process) that requires involvement of every team member. If anyone fails to do his/her part, everyone is penalized in some manner.
2. **Individual accountability.** Each student in the team is held responsible for doing his/her share of the work *and* for understanding everyone else’s contribution.
3. **Face-to-face promotive interaction.** Although some of the group work may be parceled out and done individually, some must be done interactively, with team members providing one another with questions, feedback, and instruction.

4. ***Appropriate use of interpersonal and teamwork skills.*** Students should be helped to develop leadership, communication, conflict resolution, and time management skills.

5. ***Regular self-assessment of team functioning.*** Teams should periodically be required to examine what they are doing well together and what areas need improvement. [35]

To successfully implement this technique in the classroom, the lesson plan must establish a clear goal, but allow the students freedom of interpretation and design. Allowing independence will draw the students into the project and allow for new ideas and solutions. This also gives the group a valuable lesson in leadership, cooperation, and time management. It is also important to have clear, defined rules on how much each team member contributes. If not everyone participates, the whole group is penalized. [35] Having such a focus on group effort enforces more interaction, rather than the team compartmentalizing tasks. Students will then be knowledgeable in all aspects of the design, and not just their own individual section. Throughout the process, students should be assessed on how well their group is interacting, and what areas need to be improved. Allowing time for students to reflect on their group dynamics helps them improve in team work, and creates a better environment to learn the core subject matter.

#### **2.4.4. Input from Danish Educators**

Several Danish educators were interviewed in the process of gathering relevant information regarding the development of the outreach programs. [13-15, 37, 38] Perhaps the interview most relevant to the outreach programs was that of Per Velk, the head of development at the Experimentarium (a Danish science museum packed with hands-on exhibits aimed at teaching students of all ages in a fun, interactive manner). Per, being the father of both a *folkeskole* student and a *gymnasium* student, was able to relate to the many complexities of increasing interest in science and engineering. In particular he felt that the best way to get children interested in the fields was for them to have a good teacher (which unfortunately is difficult to affect directly). [37] He also mentioned that the best way to get the attention of students was to answer the question “why should we use this technology?” [37] Making the subject matter of the programs relevant to the everyday life of its participants and those running the programs would be a good way of improving the image of the programs and would facilitate the spread of the programs in

later years. Per also strongly recommended that the programs make a specific effort to include female students as much as male students.

### ***2.5.IHK History and Involvement***

Ingeniørhøjskolen i København (IHK), or the Engineering College of Copenhagen, is a progressive school located just outside the city in Ballerup. The university was founded in 1881, but moved to its current location in 1995. The campus covers 42,000 square meters and offers extensive facilities. These include very modern classrooms, high-tech labs, recreational facilities and a library.

With approximately 2,250 enrolled students, IHK offers bachelor degrees in civil engineering, mechanical engineering, production engineering, electronics and computer engineering, electrical power and information technology engineering and export engineering. IHK has an atypical education design with a focus on projects and group work mixed with short lectures to give a more real world approach to learning. IHK also provides several opportunities for foreign studies. IHK students can study abroad, and IHK also provides programs for international students. For these reasons, the IHK outlook on education can be compared to WPI's program. This same mentality allows for great collaboration and common understanding. Realizing the importance of real life experience is a huge common factor. WPI's global program fits right in at IHK making the two universities great partners. (WPI has been interacting with IHK since 2000, when the two schools signed an agreement to share resources. As a result, IHK hosts the orientation for all students attending the Copenhagen IQP site, and has recently started to furnish IQPs for WPI students.)

IHK is highly interested in increasing engineering enrollment. To that end, they have requested the following with regard to this IQP:

A discussion about middle and high school students' poor skills in natural sciences has been going on for years in Denmark (and many other countries as well). Physics and chemistry are not among the most popular subjects in primary and secondary schools. For engineering schools such as IHK there is obviously a big focus on attracting more students. So far, the strategy has been to produce pamphlets, brochures, ads, commercials, etc., directed toward the target groups.

IHK is, however, considering changing the focus towards a more direct contact to the students, teachers, etc. in the underlying educational system. This contact

could be guest lectures from IHK, "student for a day at IHK," labs and exercises at IHK, etc.

Recommendations or ideas for initiatives that can support a greater degree of interaction between IHK and the primary and secondary educational system are desired. These recommendations or ideas should be based on:

- A description on how one or more American universities or engineering schools are working to attract students and
- An analysis of differences/similarities between engineering educations in the United States and Denmark.
- Interviews etc. with Danish high school teachers and students.

Since the ultimate goal of this project is to foster interest in IHK among Danish primary school students, four IHK students have been given project credit to assess the methods and results produced by this project (see Appendix 7 for more detail). [14] It is IHK's intention to perpetuate the programs after the project team leaves Denmark.

## ***2.6.LEGO History and Involvement***

The LEGO Corporation was founded in 1932; its purpose has always been "to inspire children to explore and challenge their own creative potential." [39] Ever since its inception, LEGO has designed new products intended to stimulate young minds. This passion for encouraging children's learning led to the creation of the Mindstorms NXT kits, which are simplified sets of electrical and mechanical parts that allow for a user to design, build and program a relatively simple LEGO robot. It is this complex technology in a simple package that is appealing to use for this project. By utilizing pre-made kits that have motors, sensors and even a central processing unit, a program can focus on design and engineering over acquiring the parts and assembling them into a user-friendly interface. Therefore, it became clear that the LEGO Mindstorms kits were optimal for an electrical and mechanical engineering program within this IQP. The main concern regarding this kit was the cost: Mindstorms kits retail for 250USD. Schools that otherwise might wish to explore engineering in the curriculum could back down if faced with a seemingly excessive cost. However, LEGO has graciously provided us with five educational version Mindstorms kits to be used at *gymnasier* in Denmark. The kits will all be left with IHK, so that any *gymnasium* wishing to implement the LEGO Mindstorms

program in the future will have access to the kits at no cost. This would facilitate the spread of our program to more schools.



### 3. Methodology

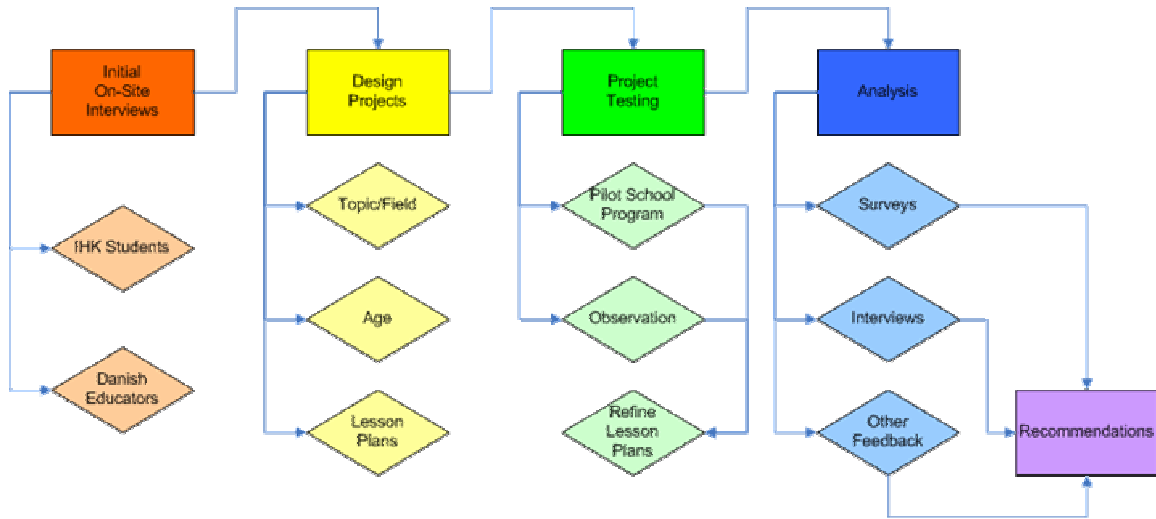

Figure 3.1: Methodology flow chart for on-site work.

#### 3.1. Target Age Group Selection

Given the limitations of time and budget for this project, it was necessary for to focus efforts on one particular age group, in order to ensure that appropriate attention was given to the curricula. We chose to work with years eight and nine of *folkeskole* (the last two years) and the first two years of *gymnasium*. The final two years of *folkeskole* are very important because at the end of that time students must choose whether or not to attend upper secondary education, and which *gymnasium* to attend. Exposure to engineering as an exciting and accessible discipline may very well steer students towards a technical high school or pique their interest enough to simply continue education. Students at a *gymnasium* have not yet decided upon a particular field and should be made aware of the opportunities presented by engineering. [13] The last year of *gymnasium* was avoided for fear of interfering with the busy schedule typical of students in that year. [13] Targeting these years provides the greatest chance of delivering knowledge while advertising the various fields of engineering.

#### 3.2. Initial On-Site Interviews

During the first two weeks in Denmark, first-hand information was gathered about the whole of the Danish education system from as many involved groups as possible.

Interviews, focus groups and surveys were aimed at identifying the exact deficiencies that have led to the problem with engineering education in Denmark and helped to gauge receptiveness to change. This information was used to adapt preliminary program concepts to achieve the highest possible effectiveness and repeatability.

The project team conducted informal interviews with students at the Engineering College of Copenhagen to determine the level of ongoing support that can be expected from IHK students in future iterations of this project. Of primary concern was the willingness of IHK students to act as mentors or teachers for young students. Due to the suspicion that most students would be hesitant to take time from their busy schedules to volunteer, we had investigated the possibility of IHK providing wages, course credit or some other form of incentive to help students justify the use of their time prior to arriving on site. Our liaison at IHK, Professor Knud Holm Hansen, informed us that as head of the Export Engineering department, he could arrange for some project credit for students requiring academic compensation for their efforts. [14] Unfortunately, the level of commitment available from IHK students was a limiting factor in the breadth and depth of outreach programs. Therefore we designed programs that any school teacher would be capable of running untrained and unassisted.

The IHK interviews had a secondary advantage of providing insight into what is successful at attracting Danish students to science and engineering fields. Unfortunately for the purpose of this project, many interviewed students had been interested in engineering due to a family member already being an engineer, or pre-existing personal hobbies related to engineering fields. [23] A follow-up to this project in future years could be testing to see whether simply exposing Danish students to engineering can be a motivating factor in choosing engineering as a profession.

Other interviews have led to the conclusion that it would be easiest and most effective to attempt to integrate outreach programs directly into the Danish educational system as part of the curriculum. Danish classes are very open, and teachers have the advantage of being able to choose when to present certain curriculum topics. [13, 38] This setup allows for the engineering outreach programs to be integrated as direct class replacements. All teachers who volunteered to have the programs run in their class were open as to how much involvement they wanted the project team to have. They also gave

input as to the preliminary concepts within the programs and promoting seamless integration of engineering programs into their curriculum.

### ***3.3. Program Design***

During the first three weeks in Denmark, programs were assigned to different grade levels and IHK student mentors were introduced to the programs. The programs were adapted for specific grade levels by ensuring that students would be able to fully understand the concepts without oversimplification. Particular attention was paid to existing standards for math and science education as well as the available subject matter relative to each class. [40] The curriculum for each grade was designed to include activities that did not completely depend upon ability for science and mathematics, to ensure that all students would be able to make a positive contribution. The portion of the time spent on complex concepts and mathematics increased with age. There was also a specific effort made to provide programs that incorporate multiple disciplines to reach a single goal.

Six programs were developed in total. These included four for the *folkeskole* (two each for the eighth and ninth years) and two for the *gymnasium* (one each for the first and second years). The *folkeskole* programs dealt with windmills, trebuchets, bridges and export engineering. The first year *gymnasium* program was the LEGO Mindstorms program. The second year *gymnasium* program was not a hands-on project like the others, but was instead aimed at showing students what an engineer does both before and after attaining an engineering degree. All the programs are explained in more detail, in their completed versions, in sections 4.1.1 through 4.1.6; all program manuals are located in Appendices 13 through 18.

Once the specifics of the programs were developed, it was necessary to completely describe each one in a self-contained lesson plan and kit of parts. These packages were designed to be implemented by anyone not skilled in either engineering or teaching; the packages contained sufficient background information, instructions and teaching aids to successfully guide a class of students through a program with minimal (if any) outside assistance. To this end, each lesson plan includes a primer on the appropriate points of discussion for the scientific principles explored therein. Professor Knud Hansen

has been established as a permanent contact at IHK to help answer the questions of teachers who use the programs without the direct involvement of IHK or WPI.

Several logistical factors needed consideration regarding program development. The export engineering program in particular required much collaboration with the four volunteers from IHK. On several occasions brainstorming sessions were held in the project team office at IHK to discuss an overall program that would accurately portray the everyday affairs of an export engineer, and later the details of the project needed working out, again with the help of the IHK students.

The other programs required a large amount of work prior to implementation. All programs except the bridge program required demonstration materials for the classroom. The trebuchet program involved building a working model from materials provided by IHK as well as certain other parts obtained elsewhere, including cloth for the sling, barbell weights for the counterweight and string to attach the weight and sling to the frame. The LEGO model involved determining the best way to utilize the sensors and mount them to the frame, as well as mastering the educational version of the software. This process took several days of dedicated work while simultaneously developing the program “game” for *gymnasium* students, including finding the components for the game field and assembling them. The work for the windmill program mainly required locating sufficient supplies for the number of students in the pilot class. These supplies included wire and magnets (provided by IHK and the *folkeskole*), glue gun (purchased at a local hardware store), and large amounts of wood (provided by the *folkeskole*’s woodshop or purchased at a local home improvement store).

A crucial factor of this project is the objective analysis of its effectiveness at increasing engineering interest. A survey was developed to be given to students prior to and following the program experience. The survey can be found in Appendix 3. It is broken down into sections gauging student feelings regarding “perceived value of math and science,” “engineering,” “ability and expectancy,” “gender bias,” and “expectancy/intention.” [5] These sections were not distinctly separated in the student version of the survey. The most important sections to this project were the “perceived value of math and science” and “engineering” sections, because those sections include

topics that can influence a student to pursue engineering. An improvement in feelings toward math, science and engineering would be indicative of a successful program.

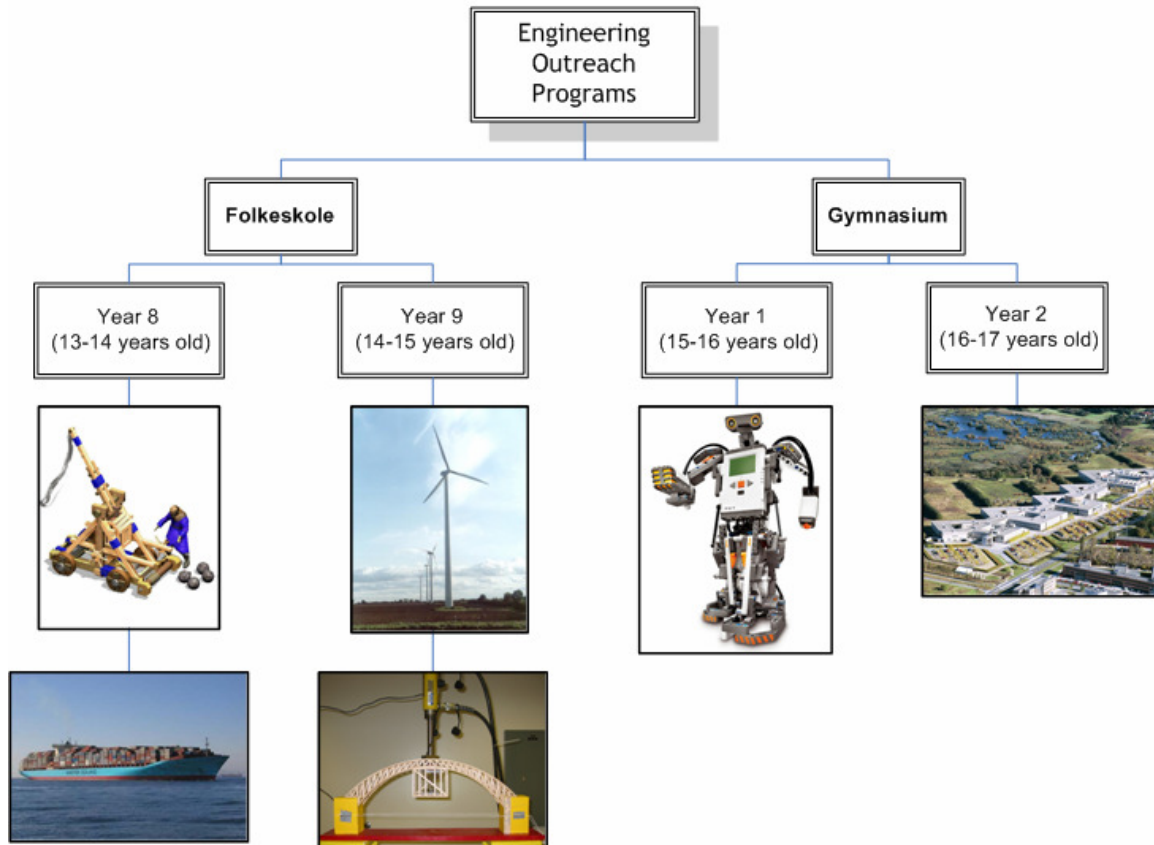

Figure 3.2: Proposed program breakdown by grade level.

### 3.4. Project Budget

The major budgetary constraints for this project were directly related to the programs. Simply obtaining the parts required for the experiments was expected to cost a significant amount of time and money. Fortunately, LEGO Corporation covered a great deal of this expense by donating five educational Mindstorms kits for use on-site, and furnishing a commercial version at half-price for program development at WPI. A major concern of this project was procuring the materials required for the other programs at low cost to encourage program implementation in Denmark. Although IHK agreed to front the costs of the programs during their pilot runs [14], our aim was to keep the cost of all materials for each program, including the startup kits for reuse, under 300 Danish kroner (approximately \$55). This limitation should encourage future program implementation at

other schools. [15] Additional costs, particularly for the windmill program, were covered by the participating *folkeskole*.

### ***3.5. Program Testing***

During the program testing phase, we implemented some of the programs at Østerhøjskolen (*folkeskole*) and Christianshavns Gymnasium and gathered survey data and observations. The programs were all run with at least one volunteer IHK student present to facilitate any language barrier issues. An initial survey was conducted to determine existing interest in, knowledge of, and ability for engineering. The survey questions are located in Appendix 3. For the duration of the program we monitored reactions of students, mentors and teachers. We also recorded our own personal observations to document the entirety of the process. At the end of the program, participating students filled out the same survey as at the beginning of the program to determine changes in attitude regarding engineering.

Upon the completion of the programs, we ran a program presentation fair at IHK so that students could showcase their products to other students, parents and teachers. More importantly, the exhibition was aimed at attracting teachers from other schools to further interest in the programs. The fair featured students from Østerhøjskolen displaying their windmills. Unfortunately, due to the short notice and the timing of the event (a Monday afternoon), no teachers were able to attend. However, teachers who ran the programs with their class were asked to inform their colleagues about the programs, and IHK will be posting the program materials on their website.

### ***3.6. Analyzing Outcomes***

For the final two weeks of our project, we analyzed the results of the program tests. Program success was quantified by comparing the pre- and post-program survey results and by examining behavior toward engineering during the program. Students were asked to write any comments they had regarding the program experience on the back of the post-program survey. These comments, along with oral feedback and survey responses from program participants, were used to determine the overall success of the program from the participants' view, to see which aspects of the programs students did

and didn't like, and to seek areas of improvement for future implementations of the programs.

The thoughts of the mentors regarding the programs were documented (the IQP team, IHK students, and any involved teachers) to gain their viewpoints on the overall success of the program, and also to see which aspects of the program were thought to be either successful or needing improvement. This feedback was used to improve the program manuals to ensure that they were all more effective at achieving the goal of increasing engineering interest to young Danish students.

It was ultimately decided to leave all program materials in their original English form rather than translating to Danish. Many teachers felt that using the English handouts would incorporate another facet to the experience, and would also facilitate the allocation of more time to the programs, as it would cover English in addition to math and science. Once the booklets were completed, physical and digital copies of the program manuals were left with IHK and the participating *folkeskole* and *gymnasium* to facilitate future implementation of the same programs.

## **4. Results & Analysis**

This section details the outcomes of this project, including the finalized programs ready for implementation in Danish schools. Danish student and teacher responses to the programs are used for qualitative analysis of how successful the programs were at achieving their goals. The survey results are also analyzed to quantify the success of the programs. Danish motivations for pursuing an engineering career are discussed, followed lastly by an examination of the future of the programs in Denmark.

### ***4.1. Hands-on Engineering Programs***

This subsection describes the six programs developed while in Denmark. These programs were all modified with the input of IHK student volunteers and after running some of them at the volunteer schools. The teacher and student program handouts are located in Appendices 13-18.

#### **4.1.1. Trebuchet Program**

The programs in sections 4.1.1 to 4.1.4 are designed for *folkeskole* students. For the trebuchet program, students are given a scenario that requires the use of a trebuchet for defense (i.e. your medieval castle is being approached by Norman invaders. Design a defense system using the following parts...).

For the first hour of the program, an introduction to the problem statement (similar to the one begun above) is given. The mechanics of the trebuchet's operation are discussed briefly, and teams are introduced to the kit of parts. There is an included hand-out, which explains the basic physics necessary to the operation of trebuchets for the benefit of students and teachers. Students are divided into small groups of about five students, and begin brainstorming. For a period of approximately one hour following this, students create a complete and detailed drawing of their trebuchet design. Due to the relatively complex nature of the trebuchet, these designs must be approved by a mentor prior to construction. Students, upon receiving approval, will then have to decide how to cut and drill the wooden pieces provided to them from the kit of parts. Students mark any necessary cuts or holes needed for construction of their trebuchet design. After a second



check to ensure the design is reasonable, students will begin construction. Teachers can perform any operations requiring power tools, whereas students can perform safer tasks, such as hand sawing and hammering.

During the next two to three hours, students assemble their trebuchets and test them only within their group. The overall goal is for the trebuchet to be accurate and powerful. In the first test, maximum range will be assessed from firings. In the next test, students are asked to launch a projectile at a stationary target from any position on the field. Groups will be ranked on proximity to the target. This method emphasizes precision more than simply distance. This method also encourages an engineer's thinking process, as the projectile must be thrown accurately rather than simply as far as possible. During the last hour of class time, students test their trebuchets in front of the rest of the class to see whose product is the most successful at achieving the goal. A wrap-up discussion takes place regarding the engineering process students experienced.

#### **4.1.2. Windmill Program**

The windmill program teaches students mechanical and electrical engineering by having them design and construct a small wind-powered turbine capable of generating electricity. Prior to the program, a predefined amount of materials are purchased for each group, including wood, nails and screws. Those materials which are more difficult to obtain, such as magnets, wire and a multimeter, are located at IHK for teachers to borrow when needed.

The first hour of class time begins with an introduction to the history and theory of wind power. An example wind turbine and hands-outs are available to the teachers to supplement their knowledge of the basic principles of physics used in the design of wind turbines and for use as reference material by the students. After demonstration of basic concepts the students are divided into groups and allowed to brainstorm.

During the next two hour period, students design their turbines. The example turbine remains available for student reference; mentors are available for design consultation. The students first draw a detailed diagram of their design for inspection. Once a teacher or mentor has verified the design, students mark the supplied lumber for machining and obtain any fasteners (from the list of parts that have already been

purchased) that they require. In the same fashion as the trebuchet program, students may use hand tools and request that a teacher perform any power tool operations required.

In the next two hours, students construct their turbines according to their previously generated designs. Mentors provide assistance as necessary and perform any last-minute woodworking. At this point mentors identify design flaws and question the students as to their implications and potential fixes, without providing a definite solution. This process requires the students to think critically about their designs and helps ensure that each turbine functions as well as possible. Students join the mechanical and electrical portions of their turbines.

For the final hour, the turbines are tested for their power generation capabilities. In order to achieve the most realistic results, the test should be performed outdoors; the power output of the turbines is tested with a multimeter. Students discuss their designs as a class and attempt to identify the best features of each design. A teacher-led debriefing discusses those aspects of the program that are common tasks of different engineers.

### **4.1.3. Bridge Program**

The bridge program introduces students to design scenarios involving budgeting. Not only do the students design a structurally sound bridge, but they are also introduced to how important resource allocation is to engineers. This program is different from some other bridge-building competitions in that it adds the element of efficiency, a key engineering concept. The bridge that can hold the most weight does not necessarily win; instead, the bridge that can hold the most weight per unit cost will be judged the best.

In the first hour of class time, the students are introduced to basic concepts of structure. Various bridge types will be described to the students through the student manual. After the students have a simple introduction to bridge design they will be in charge of choosing what style would be best for this particular project through further research on the internet. The first hour also includes budgeting tips. Certain tips include how planning the final product will cut back on wasted material and other basic recommendations on how the students should handle their budget.

During the next two hours of the program the student groups are given a price list for the materials that are available for use in construction. Students then begin the

planning process. After receiving the materials list, the students will use technical drawing templates to draw and plan the actual design of their bridge. After completing a bill of materials list, the students can purchase whatever materials they want knowing that all materials used will be added to the final bridge budget. Since the glue for the bridges needs time to dry, the students can begin assembly during this time.

The fourth through sixth hours of the program are completely dedicated to building and finishing the bridges. During the final hours of the program, the bridges are tested to see which one can withstand the most weight. The instructors then calculate the amount of weight each bridge can hold compared to the cost of the bridge to determine the most efficient bridge.

#### **4.1.4. Export Engineering Program**

Export engineering is a program designed to combine engineering with the “softer” fields of languages and writing in order to foster international business relations. Students involved in the major take not only standard engineering courses (math, physics, etc.) but also language and communication courses. The major is designed to introduce students to process streamlining and business markets in the context of engineering.

In the export engineering program, the class is divided into five groups or “countries” and students are allowed to choose a problem they would like to solve as a group. The students then design new technology which solves the stated problem. Each country is then given certain “natural resources”. These resources are later used to create the piece of technology they design. To practice negotiation skills and to foster interdependence, the students must trade, sell, and barter with the other groups. Since export engineering deals heavily with international trade the groups are expected to speak English during transactions. Groups then have a certain amount of time to assemble their product. At the end of that period, student groups present their products to the remainder of the class. The “countries” then have an opportunity to improve upon their designs after hearing other groups’ designs and suggestions. They are required to ask permission of other groups if borrowing from their designs (to simulate copyright laws and patent protection), still under the language restriction. At the end of the students’ engineering process, each group determines the value of the other groups’ product, and the most

successful team is the one with the highest valued product. Finally, a debriefing of the export engineering program is given to students.

This program was developed in conjunction with the four student volunteers at IHK, who all supported this project as representative of their field and appropriate for implementation in *folkeskole*.

#### **4.1.5. LEGO Mindstorms Program**

The programs in sections 4.1.5 and 4.1.6 are designed for *gymnasium* students. The LEGO Mindstorms program is the most sophisticated of all six programs. As such, it requires the most time in the classroom. The time allotment for this program is twelve hours of project work.

The first hour of the program is an overall introduction, which includes a primer to the basics of programming. The method of introducing students to computer programming is similar to “Peanut Butter and Jelly Programming,” a simple exercise in which students form small groups and write down detailed instructions on how to construct a peanut butter and jelly sandwich using only peanut butter, jelly, two slices of bread, two knives and a plate. Using the list of instructions the students have prepared, a mentor then follows them step-by-step in front of the class to gauge its accuracy. Students then are able to clearly see which key steps have been left out due to oversight. In the Danish version, the peanut butter and jelly sandwich is replaced with the Danish specialty, *smørrebrød* (an open-faced sandwich). This exercise serves as an excellent introduction to the realm of computer programming, as a properly programmed robot will perform exactly as it is coded. However, if time is restricted, this portion of the introduction may be omitted. The remainder of the first hour is devoted to introducing students to the software used to program the LEGO Mindstorms robots.

The bulk of the remaining time is devoted to student group work. At the start of the second hour, the game sheet is distributed to students, and they can see the game board and learn the rules of the challenge. Students are then broken into groups of about five, and have to brainstorm possible ideas of achieving the program goal. Each student group is divided into a building team and a programming team; the former is in charge of assembling the robot and attaching all the sensors that are deemed necessary by the team

(using the provided manuals if time is short, or designing from the ground up if more time is available), while the latter is responsible for using the Mindstorms software to program the robot to play the game. The groups will receive minimal help from any mentors in order to foster a discovery-based learning environment. Teachers or mentors are responsible for ensuring that students stay on task and are productive throughout the time period allotted.

The final hour of the program is used for testing the completed robots against each other to see which best performs the game. According to the game plan provided with the manual, the field is a 1-meter by 0.75-meter white plastic board with a black tape “x” spanning the field. Situated at each corner is a ball holder which holds either a red or blue plastic ball (holders and balls come with the Mindstorms kits). The robot must knock down the two red balls and leave the two blue balls on the holders. The positioning of the balls is random for each test, but behind the red balls are speakers emitting a continuous beep. Ideally, students will have the light sensor determine how to drive toward the ball, the ultrasonic sensor to stop the robot before hitting the ball holder, and either the light or sound sensor to determine if a ball is red or blue. The task is simple enough such that it can be completed in a relatively short amount of time by a focused team, but complex enough that the whole team must work together to design, program and troubleshoot the robot. Any team which knocks over only the appropriate balls has successfully achieved the goal; tiebreakers may include fastest time or most elegant program, among several other options. After testing is completed, a discussion session is held where the teacher explains that the building team performed tasks common to mechanical and electrical engineers and the programming team worked in the same manner as some computer scientists. Finally, all Mindstorms kits are put away and returned to IHK upon completion of the program.

#### **4.1.6. “Experience Engineering” Program**

The Experience Engineering Program is very different from the programs developed for the earlier years. Rather than continuing with another program, a new approach was taken with the older students who are starting to look at what to do after *gymnasium*. In the unspecialized *gymnasium*, pupils have not necessarily chosen a career

path. This program focuses on available engineering fields when looking at potential colleges, and actual careers in engineering. There are two sessions for this particular program, the first of which involves guest lecturers. These are speakers who currently work in an engineering field and show the students a glimpse of life as an engineer.

The second session focuses on the students' more immediate future in college, because students begin visiting colleges in the last year of *gymnasium*; an earlier introduction to IHK may prove beneficial for student comfort and may help solidify the choice of school at an earlier age. The second session features an IHK-student run laboratory using the facilities of IHK, followed by a brief discussion about the experience of being an engineering student. This exclusive visit should leave a lasting, positive impression with students about IHK and engineering.

#### ***4.2. Program Implementation***

There were several setbacks with the implementation of the programs at Danish schools. The main problem was the general lack of success in arranging class time with Danish schools. With the help of the four IHK student volunteers, several *folkeskoler* (Østerhøjskolen, Højagerskolen, Egebjergskolen, Rugvænget Skole, Skoleværkstederne, Hedegårdshallen, Grantofteskolen) and *gymnasier* (Christianshavns Gymnasium, Aurehøj Gymnasium, Ordrup Gymnasium, Gammel Hellerup, Borupgaard Gymnasium) were contacted during the first weeks of March in addition to the schools contacted before the project team arriving on site in early March. One month later, only three *folkeskoler* had not turned down the project team and only one *gymnasium* had scheduled any lectures to run the program. Fortunately this *gymnasium* teacher taught both first and second year students. In the end, only one *folkeskole* was able to appropriate enough class time during the specified time period for the project team to run the programs. As a result, the bridge, trebuchet and export engineering programs could not be implemented in *folkeskoler* because not enough classes were available to implement them. Instead, these three programs were developed and finalized during the implementation of the other programs. By the end of the project, printed material for all six of the programs was compiled and available for distribution.

The most successful implementation was with the LEGO Mindstorms program. We received a response from two teachers at Christianshavns *gymnasium*, Mads Petersen and Mette Grage. Both these teachers were very enthusiastic about having our programs run in their classes; they were both unable to allocate as much time as we had initially hoped. We received five hours of class time with Petersen's class, which was much less than the twelve hours we had initially planned for the activity. Mette Grage unfortunately had to cancel the program because most of her available hours occurred after the project team had left Denmark. Due to the shortened time available to run the program, many efforts were taken beforehand to ensure that the goal could still be attained. These efforts included sorting the LEGOs into the trays provided with the educational versions of the kits, having demonstrations led by the project team (rather than asking the teacher to learn the material beforehand), skipping the *smørrebrød* activity at the beginning of the program, building the robot from the provided instruction manual rather than from the ground up, and having student groups work simultaneously at developing a program and building the robot. The project team's observations and reactions to the implementation of all programs are located in Appendix 11. Perhaps the most surprising observation was that all students were engaged and excited about the activity despite holding the first day of the program with Petersen's class on a Friday afternoon. Students were very enthusiastic about the program and jumped right in. Most students immediately knew whether they wanted to build a robot or develop the computer program necessary to have it play the game. This was especially surprising because the class was in the "language track," meaning students had already decided to study the "softer" fields of Danish, foreign languages, history, and social sciences rather than take math and science courses. It was decided on-site that all students should have the basic introduction to the LEGO Mindstorms programming software so that they could all have the appropriate background knowledge when it came time to start testing the robots on the field.

The other major implementation was the windmill program. The Østerhøjskolen *folkeskole* expressed interest in introducing eighth-year students to the building of windmills, because it is introduced in the classroom in the ninth year. The presence of windmills in the curriculum is encouraging in terms of the longevity of this project. Students were very enthusiastic about the program. Once the teams were in the woodshop

and had their hands on the materials and tools, they needed very little encouragement along the way. The large class size of 43 students necessitated that the project team and IHK student volunteers were available for the entire time to assist students with designing and assembling the more difficult portions of the windmills. Seven full hours were allotted to the program by the school, which was much closer to the proposed amount of time. In that time, students were introduced to the program, filled out the pre-program survey, were given a brief introduction to the concept of moving magnets past wire coils to generate electricity, designed and built their model windmills, tested them outdoors, and filled out the post-program survey. Many teams built wind turbines that functioned in the light breeze outside, which resulted in a large degree of student pride and enthusiasm. Two groups were so excited that they volunteered on the spot to showcase their windmills at the program presentation fair. The project team was very satisfied with the *folkeskole* students' accomplishments and the length of time of the program.

The final program implementation was "Experience Engineering" for the second year *gymnasium* students. Caroline Beijertsen, a Swedish Well Site Engineer from Mærsk Oil, came to Christianshavns Gymnasium to talk about her experiences as an engineer. Students were very receptive to her, and she kept the class engaged. Among the topics discussed were schools she attended, her reasons for choosing engineering, a description of Mærsk, and her everyday job description. Unfortunately, due to a lack of time for adequate preparation, the "college" section of the Experience Engineering program was unable to be completed, despite IHK student interest in aiding with that section of the program. [23] The surveys that were administered to the other program participants were not utilized for this program mainly because of time constraints; the partial implementation of the Experience Engineering program lasted about 45 minutes, and the surveys took about 15 minutes to conduct each time.

The presence of IHK students was instrumental to the success of the windmill and LEGO Mindstorms programs. Having a Danish engineering student to discuss (in Danish) her experiences as an export engineering student at the conclusion of the programs caused several students to leave comments such as "export engineering sounds cool." This feature would continue to be a significant part of the programs if the student resources can be obtained.



### ***4.3. Survey Results***

A comprehensive compilation of the survey results can be found in Appendix 19. The same survey was administered to student program participants both prior to and immediately following program implementation. Separate versions were administered for *folkeskole* and *gymnasium* students, but the only changes between the two were references to their current level of schooling and references to the next higher level of education. For each statement, students were asked to respond on a Likert scale of 1-5 whether they strongly disagree (1) through strongly agree (5) with the statement. Survey results for all students were compared both before and after program implementation; results among individual schools were also analyzed. A major objective of the survey was to reveal trends about predominating feelings toward math and science and to determine how effective the programs were at increasing overall interest in engineering. Secondary goals of the survey included determining the gender gap (if any) as perceived in Denmark, and students' future plans for higher education.

Immediately visible with the initial survey results was the lack of a gender gap. Each of the 26 students in the class from Christianshavns Gymnasium thought that gender made no difference with regard to being a successful engineer: student responses averaged above "agree" with a value of 4.35 for women and 4.42 for men. Also quite apparent immediately was a general student dislike of math, science and engineering, as students in the class were in the "language track." Students largely disagreed (survey averages below 2) with statements referring to math and science education or engineering: "Learning math and science is fun" (1.92), "I could be a successful engineer" (1.69), "I am interested in pursuing a career in engineering" (1.62), "I would be successful in a job that required math or science" (1.73), and "I plan to take math/science classes in upper education" (1.73/1.77). Students also did not feel "determined to use their math or science knowledge in their future career" (1.92).

However, following the program, there was a dramatic increase in response averages for many of the engineering-related survey statements. Perhaps most importantly were the changes for "I know what an engineer does," "I could be a successful engineer," and "Engineering is enjoyable" (statements 5-7), with average increases of 0.74, 0.86 and 0.91 respectively. This statistic includes no students

responding less than “neutral” for knowing what an engineer does. Other notable increases were responses to statement 2 (“learning math and science is fun,” +0.52) and statement 10 (“I would be successful in a job that required math or science,” +0.77). Figure 4.1 shows the averaged response value increases for statements that had increases over 0.5. Although these values are statistically questionable (there were eight fewer surveys returned after the program than before), they still suggest strong trends in a favorable direction, namely that knowledge of and interest in engineering was enhanced. These trends are further supported by oral and written student feedback solicited at the time of the post-program survey. One student said she felt she was not going to like the program beforehand, but “actually enjoyed it a lot.” Other students wrote that the program “was a good way to learn about the subject,” and “was super cool to try.” Generally, the feedback received from participating students was constructive and positive.

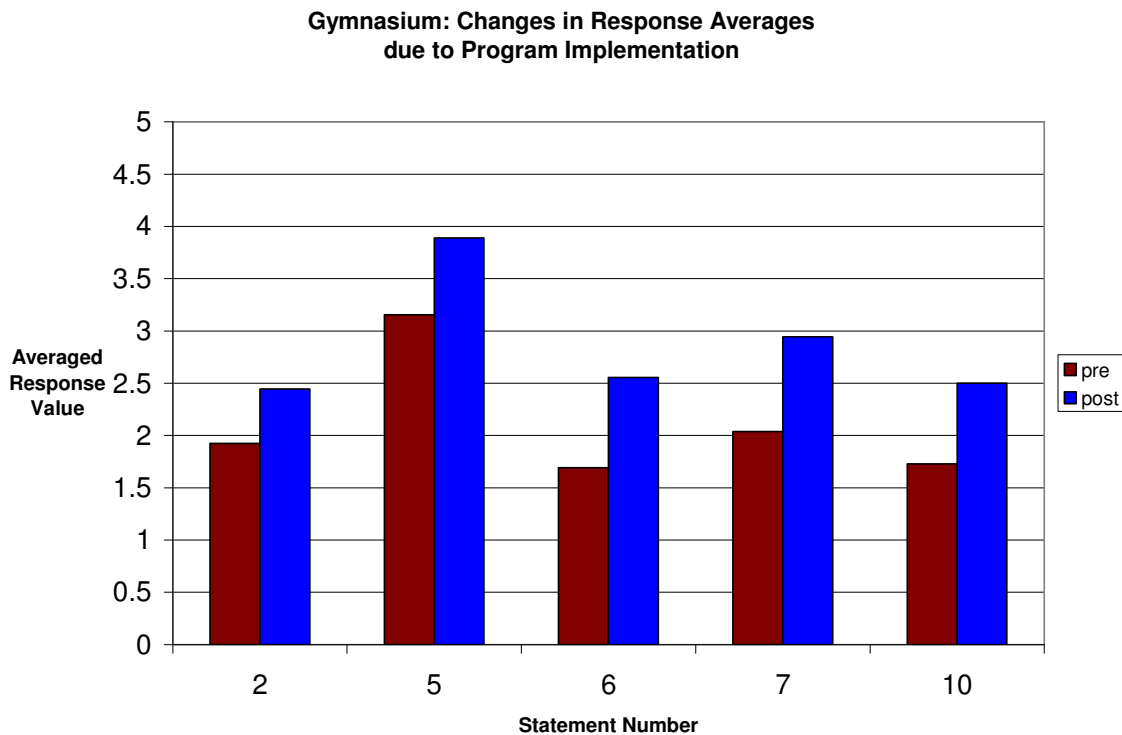

**Figure 4.1:** Program implementation effect on *gymnasium* students.

In general, the *Østerhøjskolen folkeskole* surveys changed less favorably with regard to the project goal compared to the *gymnasium* surveys. The most notable

difference between the two data sets is that the pre-program survey averaged response values tended to be much higher in the *folkeskole* than the corresponding *gymnasium* values. This trend could be due to the fact that students are more open-minded with regard to engineering, or have not yet started to think about their career paths or even possibly which *gymnasium* to attend. However, over the course of program implementation, four statements still saw an average response increase of 0.5 or more (2, 5, 6 and 7, with increases of 0.78, 0.58, 0.55 and 0.68, respectively). It is encouraging that these four statements also saw large increases in the *gymnasium*. Again, it is important to note that these are simply empirical observations and could be statistically questionable, especially since the number of students completing surveys was less after the program (33 students after compared to 43 students before). Reasons for this decline in both schools may include students not attending class the last day of the program, or disinterested students not returning the post-program survey (which may skew the results in a positive direction, which was one reason the cutoff value was set at 0.5). This theory would be supported by noting that statement 9 (“I have been doing well in math and science this year”) spiked 0.55 points in the *gymnasium* surveys, a statistic that is hard to explain otherwise.

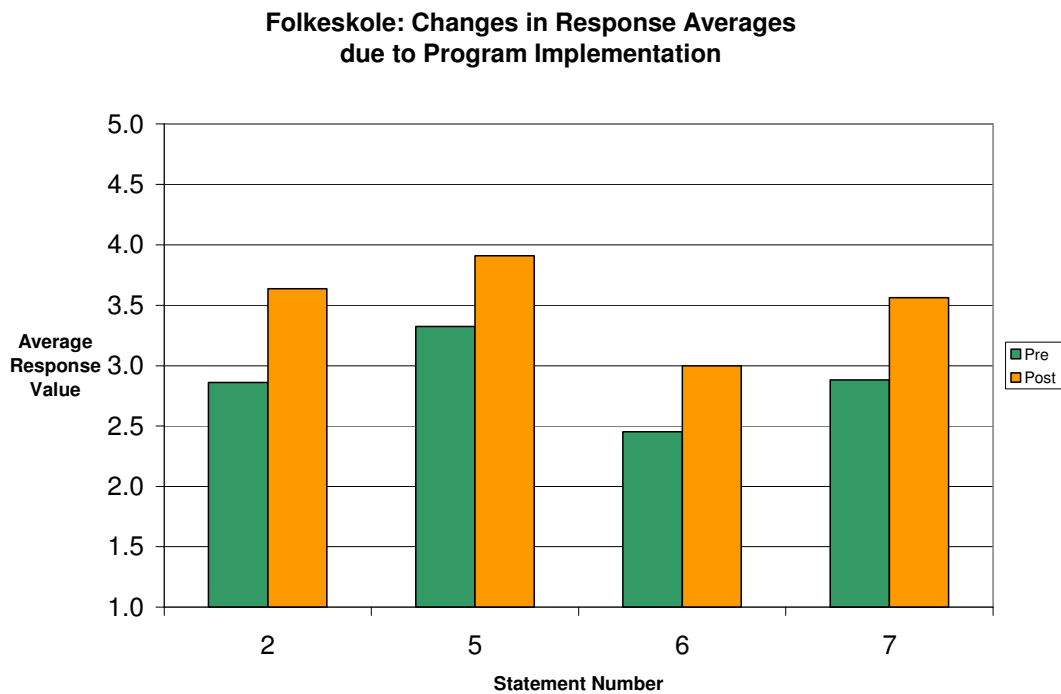

**Figure 4.2:** Program implementation effect on *folkeskole* students.

In addition to the numerical data, *folkeskole* students were also verbally supportive of the program. Five students volunteered on the spot to attend the program presentation fair to demonstrate their windmills, and several others approached the project team to say how much they enjoyed the program.

#### ***4.4. Danish Motivations for Engineering***

Based on several interviews and the results of the program implementations, there are several conclusions that can be drawn about Danish motivations for pursuing engineering as a profession. Denmark produces much fewer engineers compared to larger nations such as the United States or China. [29] As a direct result, Denmark benefits most by focusing on specialty areas in which they hold a leading edge, including combining engineering with “softer issues” such as societal needs. [29] Another Danish specialty is wind turbines, which was the main reason a program dealing with the construction of working windmills was developed.

It appears, from observations during program implementation, that many Danish students in primary and secondary schooling have preconceived notions about the nature of work of engineers. Many had the impression that engineering consisted of solely studying math and physics in college, and doing strictly computational work. However, in class after having experienced what some engineers actually do for a living (between both the LEGO Mindstorms program and the windmill program), as well as when the IHK student volunteers explained what they did as export engineers, many students became much more interested in the subject matter than they were at the beginning of the program. This was evidenced by student response increases to survey statement 5, “I know what an engineer does,” as well as oral comments and enthusiastic behavior from the majority of students. Many students participating in the windmill program seemed to be much more encouraged once members of the project team said their designs looked very good, and saw that even outside in the wind, their windmills actually worked. These same students also cheered during the project introduction and wrap-up when it was mentioned that Denmark was a world leader in windmill technology.

Despite success from the students’ perspective, the issue with having these programs implemented may lie with the teachers. Many *folkeskole* teachers have little

time to adequately prepare for lessons about which they have little background knowledge, and might be reluctant to try out an abstract program such as those presented by this project. [13] Another issue altogether is finding the time in the classroom to incorporate these programs into the curriculum. [13, 29] This dilemma was counteracted by choosing topics that either already exist in Danish curriculum, or by covering several topics taught in classes in order to be able to draw class time from multiple subjects.

Perhaps the most interesting result was that the improved post-program outlook on engineering was common across communities: Christianshavns Gymnasium is located in the heart of the city of Copenhagen, while Østerhøjskolen is located in more rural Ballerup. Despite being in contrasting settings, students from both areas reacted very positively with regard to exposure to engineering. This result is very encouraging for future implementation of the programs developed by this project, and suggests that the success and longevity of the programs will not be an issue.

#### ***4.5. Program Continuation***

After the implementation of the windmill, LEGO Mindstorms and Experience Engineering programs, observations and survey results were taken into account in the revision of all programs. The completed versions of all program materials (including the comprehensive teacher's guide, student handouts and any other supplementary guides) are reproduced in completed form (except formatted for letter paper rather than A4) in Appendices 13-18. PDF versions of all program materials were provided on CD to IHK for placement on their website and other distribution as IHK saw fit. Additionally, the materials created for use with all groups were left with Knud Hansen at IHK. (These supplementary materials included the five Mindstorms kits for the LEGO program, the weights, cloth and trebuchet model for the trebuchet program, the magnets for the windmill program, and a glue gun for the export engineering program.)

The four IHK student volunteers from Export Engineering are following up on this report with recommendations to IHK on how to best proceed with the programs created by this project. Presumably, since IHK has chosen to continue to fund and support these programs, additional student resources will be allocated in the future.

## **5. Conclusions & Recommendations**

This Interactive Qualifying Project was successful at achieving its goal during the time when the project team was on site in Denmark, and promises to continue its success afterward. The engineering outreach programs created during this project increased interest in science and engineering among students during the pilot runs, were relatively inexpensive to launch and maintain, and are able to be implemented again with materials left at the Engineering College of Copenhagen. Due to the limited amount of time that the project team was in Denmark and the limited amount of class time Danish teachers were able to afford for the pilot runs, all of the programs could not be implemented; however, based on what results were obtained, both the project team and sponsor were optimistic about continuing positive outcomes in the future.

Several factors allowed the project to be as successful as it was. One major reason was the receptiveness of the participating teachers to having this engineering experiment take place in their classrooms. Students were also, almost unanimously, interested in learning about engineering despite being in varying settings and from differing backgrounds. Both the project team and IHK are confident that the programs developed by this project will continue to excite young Danish students about engineering well into the future.

The project team strongly recommended to IHK that the programs be continued in Denmark starting in the fall of 2007. Implementing all six programs will greatly increase the amount of exposure to engineering Danish students receive. It is hoped that the propagation of the programs will, in time, help to increase engineering enrollment at Ingeniørhøjskolen i København.

Based on the work completed this term, there are several areas in which this project can be continued for future work. Following are several suggestions which could lead to additional Interactive Qualifying Projects at the Copenhagen project site and possibly in conjunction with IHK.

Many Danish teachers (and some students) reported dissatisfaction with the currently available supplementary materials for chemistry and physics classrooms. At present, most science classes are held in classrooms that have none of the posters, models

or other adornments relevant to the subject matter that can be found in many American classrooms. An effort to develop and distribute models and other materials that are designed to stimulate young minds and excite students about science would be highly appreciated in Danish schools.

Starting with our model of implementing hands-on programs into Danish lower-level education, new programs could be created. Due to the limited time available to work on this IQP, only five hands-on programs could be created (plus the Experience Engineering program). Future projects could develop and test additional hands-on programs to increase the total number available to Danish *folkeskole* or *gymnasium* teachers for implementation. Increasing the number of programs available would increase the diversity of the project and the likelihood that Danish teachers would want to implement them in the classroom, especially if these programs follow topics already existing in the Danish curriculum.

When responding to the calls for volunteers to run the programs, many teachers said that a big reason for hosting the program was that American students would be running it in English. Future teams working on similar projects should bear this in mind if they plan on implementing similar programs.

Unfortunately, there was only enough time available for the project team to develop, implement and analyze programs for the last two years of *folkeskole* and the first two years of *gymnasium*. Future projects could expand the window of age so that more students in *folkeskole* are targeted by programs. Following the trend set by American programs like Exploratorium [41] and Danish programs such as the Experimentarium, targeting science and engineering discovery programs at younger students could be more effective.

A section of the background that could be further developed as a focus in a future project is the psychology of teaching. A more directed approach at knowing how students learn, especially Danish students, might prove more effective in honing appropriate programs for implementation in Danish schools.

Topics that could be analyzed by future projects include trends in the number of students enrolled at IHK on an annual basis, and IHK students' reasons for choosing engineering as a major. Such data collection might suggest alternative routes to increase

student interesting in science and engineering. These topics were not explored further in this project because it was not an immediate concern of IHK (this project's main sponsor). However, these issues may become important in future years after this project's programs have the chance to be implemented and propagated.



## 6. Appendices

### 6.1. Learning Style Categories

From [33]

<b><u>Innovative Learner</u></b>	<b><u>Analytical Learner</u></b>	<b><u>Common-sense Learner</u></b>	<b><u>Dynamic Learner</u></b>
<ul style="list-style-type: none"> <li>•Seeks meaning</li> <li>•Wants reasons for learning</li> <li>•Needs involvement</li> <li>•Likes working with others</li> <li>•Imaginative</li> <li>•Divergent thinker</li> </ul>	<ul style="list-style-type: none"> <li>•Wants to know facts</li> <li>•Perceives abstractly</li> <li>•Processes reflectively</li> <li>•Creates concepts</li> <li>•Builds models</li> <li>•Data collector</li> </ul>	<ul style="list-style-type: none"> <li>•How do things work?</li> <li>•Seeks utility</li> <li>•Hands-on</li> <li>•Practical</li> <li>•How will it be useful?</li> <li>•Give it a try</li> </ul>	<ul style="list-style-type: none"> <li>•Needs self-discovery</li> <li>•Takes risks</li> <li>•Likes change</li> <li>•Follows through</li> <li>•Likes trial and error</li> <li>•Actively tests ideas</li> </ul>
<b>Teaching Method:</b> <ul style="list-style-type: none"> <li>•Motivator</li> <li>•High interaction</li> </ul>	<b>Teaching Method:</b> <ul style="list-style-type: none"> <li>•Information provider</li> <li>•Knowledge giver</li> </ul>	<b>Teaching Method:</b> <ul style="list-style-type: none"> <li>•Coach</li> <li>•Involves student</li> <li>•Feedback</li> </ul>	<b>Teaching Method:</b> <ul style="list-style-type: none"> <li>•Resource</li> <li>•Evaluator</li> <li>•Multiple learning styles</li> </ul>

## **6.2. Survey/Focus Group Discussion Questions**

(S) questions require a show of hands. (Q) questions require open-ended response.

### ***In-class Focus Group Activity for Young Students***

1. Introduce topic of engineering and identify the group as engineers
2. (S) Does anybody here know any engineers?
3. (Q) Who?
4. (S) How many of you know what an engineer does?
5. (Q) What are some things you see everyday that an engineer might have made?
6. Supplement answers with examples. Cite landmarks and common technology.
7. (S) Do any of you want to be engineers when you grow up?
8. (Q) Why?
9. (Q) Who can be an engineer?
10. (Q) What do you want to do as an engineer?
11. (Q) What do people have to do become engineers?
12. (Q) Do you think you could be an engineer if you wanted to?
13. Introduce program as an opportunity to try engineering

### ***Questions to Gauge IHK Student Interest in Outreach***

1. When did you decide to study engineering?
2. What caused you to choose engineering?
3. Did anyone in your childhood try to interest you in the subject?
4. Which type of *gymnasium* did you attend?
5. Do you recall any programs or classes that increased your interest or helped you to better understand engineering?
6. Do you feel there should be more effort made in the Danish school system to increase engineering awareness?
7. Would you be interested in participating in programs to bring engineering to the *folkeskole*?
8. How much of your time do you think you could devote to these programs?
9. Would you need any sort of compensation, in the form of wages or class credit, to be able to participate?

### **6.3. Survey for Folkeskole/Gymnasium Program Participants**

This survey was adapted from a survey in [5].

Questions are asked using the Likert scale for response (1=Strongly disagree, 2=Disagree, 3=Neither agree nor disagree, 4=Agree, 5=Strongly agree)

#### ***Subsection: Perceived value of science and math***

1. I like math and science.
2. Learning math and science is fun.
3. It is important for me to be good at math and science.
4. Math and science will be useful for what I do after I finish school.

#### ***Subsection: Engineering***

5. I know what an engineer does.
6. I could be a successful engineer.
7. Engineering is enjoyable.
8. I am interested in pursuing a career in engineering.

#### ***Subsection: Ability and expectancy***

9. I have been doing well in math and science this year.
10. I would be successful in a job that required math or science.

#### ***Subsection: Gender bias***

11. Most women use math or science in their careers.
12. Most men use math or science in their careers.
13. More women than men use math in their careers.
14. More women than men use science in their careers.
15. A woman can make a good engineer.
16. A man can make a good engineer.

#### ***Subsection: Expectancy/intention***

17. If I learn math or science well, I will have more career choices.
18. If I do well in math or science classes in (current level of school), then I will do well in (next level of school).
19. I plan to take math courses in (next level of school).
20. I plan to take science classes in (next level of school).
21. I am determined to use my math or science knowledge in my future career.

#### **6.4. Interview with Martha Cyr, 1 February 2007**

This appendix contains notes and suggestions provided by Martha Cyr, the director of the K-12 Outreach program at WPI.

- Ms. Cyr found in her personal experience that especially for females, fourth grade is the time the decision is made whether or not a student will enter engineering.
- There are two main types of programs offered by WPI's K-12 outreach program, those that are in the style of a "summer camp" and those that are "extended day" programs during the school year.
- It is important to develop outreach programs that are gender-neutral so as to hold the interest of all participants.
- Ms. Cyr suggested that it would be highly beneficial to investigate Danish educational standards and determine which (if applicable) our programs would fall under.
- The following resources were recommended to us for further research:
  - TeachEngineering.org, which has lists of K-12 engineering activities
  - TeachersDomain.org, which has engineering-related video clips and other multimedia files from WGBH
  - International Technology Education Association (ITEA) has packets organized by grade and engineering or science discipline (see below)
- If mentors for the program already have the requisite knowledge to understand the mechanics of the program, they are already equipped to answer questions and only need to be instructed to guide the students to use a self-discovery process rather than simply answering questions.
- Prior to running the program with students, mentors could also complete the same program as the student with the developers to address any questions they may personally have, but also to understand the student's thought process.
- Programs that are competition-based can sometimes be successful; major detracting factors include some students becoming obsessed with winning at the expense of learning and a decrease in female interest.
  - Suitable alternatives to head-to-head competition include contests where all students are striving for a superlative (highest speed, longest distance, etc.) rather than "winning" or "beating" other students.
  - Programs where there isn't a clear-cut "best" way of solving the problem are better because students can be evaluated on the engineering process rather than the result.
- Programs must refer back to engineering in the context of why engineering is a good thing to do (for society), and is useful. It should be explained to students that they can use math and science (but don't have to enjoy them as a prerequisite).
- Engineering should be referred to as "looking for opportunities" rather than "solving other people's problems."
- A program has a much higher chance of long-term success if an institution commits to keep it running (rather than an individual).

The following points were gleaned by perusing the ITEA booklets.

- Find out local age-appropriate Danish learning standards ASAP

Program outlines should have the following main sections:

- Title
- Purpose
- Objectives (students will be able to ...)
  - (which national/regional educational standards are satisfied)
- Materials/cost
- Preparation/time to allot
- Procedure
- Safety
- Questions to ask
- Student note sheets (with appropriate spaces for program-specific data)

Suggested topics (from grades 6-8)

Biology/Chemistry/Biochemistry

- Chromatography (dyes in drinks and markers)
- Corrosion (different removing chemicals, different forms of corrosion)
- Growing MOs (contact-Prof. Camesano)
- Making soap from lye (only if chem. lab available)

Civil Engineering

- Bridge building (tools: straws, masking tape, scissors, and weights for testing)
- City design (boullion, sugar, gelatin cubes (1/3 of water))

Computer Science

- PB+J programming (1 student is robot, rest have to come up w/simple program)

Electrical Engineering

- Circuitry (3 houses in series, make a circuit—borrow components from EE dept)
- Static Electricity (Leyden jar)

Industrial Engineering

- Quality control (number of red and total M&Ms in a bag, graph data)

Mechanical Engineering

- LEGO Robotics (can take challenges from previous years of FLL)
- Magnetic Exploration (atomic level to macroscopic level)

### 6.5. *Interview with Henrik Bang, 8 February 2007*

This appendix contains notes from a personal interview conducted with Henrik Bang, a *Gymnasium* mathematics teacher spending a year teaching in the United States.

- Danish students can transfer between high schools
- Grades 8 and 9 should be easiest to affect
- *Folkeskole* is a low pressure environment with minimal testing
- *Gymnasium* is significantly more difficult and may be too much for some students
- *Folkeskole* teachers need only be qualified in four subjects.
- At lower grades, teachers with math and science backgrounds are rarer.
- Existing after-school programs
  - Additional exposure to music, drama and arts available in the evenings
  - Biannual Festival of Natural Sciences seeks to increase interest among students
    - Guest lectures from experts available for *gymnasium*
    - *Folkeskole* students have should have something to show parents
    - IHK student visits w/ Experiments?
- School day – 8am-3pm
  - through 4<sup>th</sup> grade: “play time”/day care after school day until 5pm
  - After 4<sup>th</sup> grade: optional youth clubs every day
  - Private organizations also available 4pm-5pm
- Recommends investigating the possibility of working with youth groups
- Be aware that curriculum is not fixed at any level, could easily add programs to schedule
- Field trips are easy to set up, little paperwork – may require partial bus fare from students
- An online catalog of programs would be helpful to many teachers.
- *Folkeskole* teachers – prepare 1/3 of time teach 2/3 of time
- *Gymnasium* – ½ prep ½ teaching
- Teachers develop curriculum with input from students, not from officials
- Try to cooperate with teachers – easier for *gymnasium*
- IHK students – present shows/exhibitions to *gymnasium*
- LEGO can be difficult to integrate into curriculum as students may regard it as an event, rather than as a part of their education.
- It may be easier to integrate “fun” activities into *folkeskole*.
- Consider:
  - Forensic science may be interesting and useful
  - Catapults are good for entertainment, but may not teach well
  - Robots can be used to perform other scientific experiments
- *Folkeskole* students should not be expected to have learned algebra
- Math should definitely be included, but we must be careful to ensure that students will be able to complete calculations on their own
- 8<sup>th</sup>-11<sup>th</sup> grade equivalent would be a good testing ground, but outside help should be provided for 8<sup>th</sup> and 9<sup>th</sup>

- IHK focuses on *gymnasium* students being proficient vs. overall motivation (?)
- Women tend not to work in private sector engineering, jobs are difficult to get and benefits are not conducive to starting a family.
- 8<sup>th</sup> grades and above will be able to understand English, but we should prepare to translate technical terms.
- During March students take time to visit the next possible educational institution.
- 12<sup>th</sup> grade students may be too busy with looking at colleges to try a new program
- Group work is very important; individual knowledge is tested at the end of the year.

### **6.6. *Interview with Thom Thomsen, 25 January 2007***

This appendix contains notes from a personal interview with Thom Thomsen, the Dean of International Studies at WPI. He is a native of Denmark.

- In Denmark, extensive after-school programs are established, but more for fun than educational purposes
- Engineering is a respectable profession in Denmark, there is really no stigma associated with it
- There is no such thing as “campus life”, students only go to the campus for classes
- The dormitories are centrally located in the city not in the same area as the university
- The students may be hesitant to volunteer for the program because their studies come first
- Export engineering is a specialty of IHK, it is very similar to industrial engineering , but focuses more on international business and languages



### **6.7. *E-mail correspondence with Knud Hansen, C Term 2007***

This appendix chronicles our conversations with Professor Knud Holm Hansen of IHK during C term 2007. He is the head of the Export Engineering department. This appendix shows how the funding sources for this project were developed, as well as how the project acquired Danish students as volunteers.

**From: Lebowitz, Jeremy**  
**Sent: 24 January 2007 16:00**  
**To: Knud Holm Hansen**  
**Subject: Greetings from WPI**

Dear Professor Hansen,

Hello! My name is Jeremy Lebowitz and I am in the project group for the development of an engineering outreach program for Danish students. I am a third year student majoring in chemical engineering. The group also includes Erin Yokay, a third year industrial engineering student, and Dan Murphy, a third year mechanical engineering student. We are all very excited about this project and have been looking forward to having contact with you. We would like to make sure we are going in the right direction with our initial project ideas. If you have any suggestions or think that we have the wrong idea about anything, please let us know.

The project description we received is as follows:

A discussion about middle and high school students' poor skills in natural sciences has been going on for years in Denmark (and many other countries as well). Physics and chemistry are not among the most popular subjects in primary and secondary schools. For engineering schools such as IHK there is obviously a big focus on attracting more students. So far, the strategy has been to produce pamphlets, brochures, ads, commercials, etc., directed toward the target groups.

IHK is, however, considering changing the focus towards a more direct contact to the students, teachers, etc. in the underlying educational system. This contact could be guest lectures from IHK, "student for a day at IHK," labs and exercises at IHK, etc.

Recommendations or ideas for initiatives that can support a greater degree of interaction between IHK and the primary and secondary educational system are desired. These recommendations or ideas should be based on:

- A description on how one or more American universities or engineering schools are working to attract students and
- An analysis of differences/similarities between engineering educations in the United States and Denmark.
- Interviews etc. with Danish high school teachers and students.

Our first idea for a proposed project involves setting up a program that could be run annually. It would involve having a different project for each year of students with increasing difficulty and complexity as the student becomes older. These projects would be focused on a different area of science and/or engineering each year and would be hands-on activities designed for small groups of students to work together. The activities would have meetings that could be run by volunteer students from the Engineering College of Copenhagen. As an example, our idea for one of the

advanced projects involves the LEGO Mindstorms kit, and would have students working on a project in the field of electrical or mechanical engineering or computer science. We have contacted LEGO and are trying to arrange for the donation of several of these kits to be given to the school where we run the first projects. We would like to hear your thoughts about our ideas.

We were also wondering if you were aware of any Danish publications with information on the number of Danish students enrolled in university engineering programs compared with other fields of study. If you have this information we would appreciate you sending it along. We look forward to hearing back from you and thank you so much for your help. Our group email account is [ihk@wpi.edu](mailto:ihk@wpi.edu).

Sincerely,

Jeremy Lebowitz, Dan Murphy and Erin Yokay

**From: Knud Holm Hansen**  
**Sent: 25 January 2007 05:50**  
**To: [ihk@wpi.edu](mailto:ihk@wpi.edu)**  
**Subject: Re: Greetings from WPI**

Dear Jeremy, Erin and Dan,

Good to hear from you. I am looking forward to working with you as well and seeing you all here in Copenhagen in March.

Your thoughts and ideas sound good to me. Setting up projects (or just identify subjects, themes, etc. for further development) for each year of students could be very beneficial. For you it could also be a way to make some delimitation of the project. LEGO-projects could be one type of projects. By the way: Are you aware that LEGO is a pure Danish company? Another type could be like this, which we at present are offering twice a year to students from “grade 11-12” (last two years in the Danish equivalent to High School): An opportunity to attend a half-day seminar, where a professor (from Chicago! Richard Gesteland) teaches “Intercultural Communication” or “Cross-Cultural Business behavior”. It has been quite successful on this level.

Maybe you can find some valuable information at <http://www.ciriusonline.dk> (choose English) [http://www.ciriusonline.dk/Files/Filer/Publikationer/2006/The\\_Danish\\_Education\\_System\\_-\\_2006\\_Second\\_edition.pdf](http://www.ciriusonline.dk/Files/Filer/Publikationer/2006/The_Danish_Education_System_-_2006_Second_edition.pdf) The biggest problem about numbers, statistics, etc. is, that is has to be in English. If I can find something relevant I will let you know.

Please feel free to contact me if you have questions about the project, or just like to know something about Denmark, IHK, etc.

Med venlig hilsen (“With Kind Regards” or “Sincerely,”)  
Knud

1<sup>st</sup> lesson in cultural difference:

Knud is my firstname. Hard to pronounce for Americans, but something like “canute”. When I visited US back in October the officer at the immigration booth said: “Are you not (nut?) Hansen?” – Well, it wasn’t the right place to tell jokes, so I just replied: “Yes, sir!”. In Denmark

(all over Scandinavia, but not typical in the rest of Europe) even students use the professors first name. You are of course welcome to do so as well, even I know you might feel it “strange”.

**From: Lebowitz, Jeremy**  
**Sent: 31 January 2007 23:25**  
**To: Knud Holm Hansen**  
**Subject: Re: Greetings from WPI**

Hello again! We have been in contact with LEGO. Our American contact has been talking with some contacts in Denmark, and they have shown initial interest in getting us Mindstorm kits in Danish. The Danish LEGO employees have sent us a few questions, including who our contact at IHK was. We were wondering if it would be alright to send them your email address and name in association with our project. We just wanted to make sure that you were comfortable enough with our project to be able to answer any questions LEGO might ask you. I have attached their questions and our answers below.

In other news, we are about to launch our project website, which will have our introduction and background research, as well as some initial plans for our stay in Denmark. We will send you the link when it is up and running. Again, let us know if it is alright to send LEGO your email address.

>How is the Engineering College of Copenhagen (IHK) involved and can you refer me to a contact person?

IHK and WPI have been cooperating through the Interactive Project for several years. This year, IHK has asked us to work on the project involving math and science interest for folkeskole students, since IHK is experiencing a decline in engineering enrollment. They will be providing us with working space for ourselves and to carry out our project with the younger students on their campus. We will e-mail our liaison at IHK and let him know you will be contacting him shortly.

>Which Middle schools in Denmark will they be cooperating with?

We have only recently begun talking with our contact at IHK, so we have not yet identified middle schools to be involved in this project.

>Do they expect to create curriculum relevant teaching material for science...or is it more some FLL warm up activities?

We expect the outcome of our project to be a teaching tool that allows college students at IHK or teachers with little engineering background to lead younger students through the activities we will be designing. We mentioned FLL because we liked its small student-to-mentor ratio and high degree of interactivity. However, we think that there are broader applications for the Mindstorms kits than just the FLL program. Our limited time in Denmark, coupled with the large target age group of our project, leads us to want to try a different approach to introducing students to engineering using Mindstorms. Our project may actually increase interest in FLL after students are exposed to Mindstorms.

>Will Danish IHK students be involved?

Our intent is for IHK students to be involved, which was one reason we were considering holding the program at IHK. We would like them to run the programs with our help when we are there (and independently in future years), based on the field they are studying.

>Why is this specific project not mentioned in the pdf you sent me earlier?

The pdf sent before was from a publication compiling already completed and published projects. Our project will not be listed until it is complete.

To address your concern about the benefits for LEGO Education:

Our ultimate goal is to leave behind a sustainable program for the advancement of Danish science education. This program will highlight many fields of engineering and science. By using LEGO Mindstorms to teach electrical and mechanical engineering concepts, we will not only increase childrens' interest in engineering and educational toys, but also in programs such as FLL. We expect that upon the successful implementation of our program this year, it will be adopted by other schools around Denmark.

**From: Knud Holm Hansen**  
**Sent: 3 February 2007 16:52**  
**To: [ihk@wpi.edu](mailto:ihk@wpi.edu)**  
**Subject: Re: Greetings from WPI**

Hi there,

Sure, no problem.

My contact information for LEGO is (Danish/English):

Knud Holm Hansen  
Studieleder/Head of study – head of department  
Eksportingenioeruddannelsen/Export Engineering  
Ingenioerhoejskolen i Koebenhavn/Engrg. College of Copenhagen  
Lautrupvang 15  
DK-2750 Ballerup  
Phone: +45 44805200  
Direct: + 45 44805203  
Fax: + 45 44805210  
E-mail: [khh@ihk.dk](mailto:khh@ihk.dk)

LEGO are more then welcome to contact me for further information.  
I have attached the more formal agreement between WPI and IHK – if needed.

Looking forward to visiting your website.

Venlig hilsen  
Knud

**From: Knud Holm Hansen**  
**Sent: 11 February 2007 07:01**  
**To: [ihk@wpi.edu](mailto:ihk@wpi.edu)**  
**Subject: Re: Project Update**

Hello there,

Before answering your questions, I can inform you that I have been in contact with Mr. Kristian Oestergaard (from mikrov.dk). It seems that Lego are interested in your/our project and will donate some (?) Lego Mindstorm. I am not quite sure, but to me it sounded that Lego would be more interested in projects towarded against students (ages 15-18) in “high school” (Danish: Gymnasium) than “folkeskole”.

You were also asking about statistics and numbers. Try [www.uvm.dk](http://www.uvm.dk) (English).

Answers to your questions are put in below:

-----  
*Hi, hope all is going well. We have run into a few issues that need your input.*

*We would like to know if there are any folkeskoles that would be interested in signing up to send students to our program. We are looking for about 10-20 students for each school year from ages 9-14.*

Well, I guess so. However, 6 times 10-20 students are a lot, and will need some time to be organized. IHK are located in a municipality called “Ballerup Kommune”, which are responsible for the “folkeskole”. We have a well-established network, so it might be easy to make some contacts.

*We were wondering if IHK would be offering facilities to hold the after-school programs at. If there was a room we could use on campus, that would make it easier to have students from any folkeskole (and maybe more than one) attend the program. If you are interested in contact with students from the “gymnasium” we have a school located very close to IHK.*

No problem. Does it necessarily have to be “after-school”? It might be easier to organize something with a teacher and a whole class from the “folkeskole” during their regular hours.

*We were hoping that it would be possible, once we get to Denmark, to have some professors ask their students if they would be interested in being mentors for our program. We were also wondering, if no students volunteer for the position, if IHK has any funding that would be available to compensate students wanting to be paid for the position, or if IHK would be able to arrange some class credit for students wishing that form of compensation.*

There are three options. I guess the last one will be the most successful. As a “head” I can organize it as an optional course/project for at least some Export Engineering students.

*What sort of facility will we be working in? Is there a computer lab that we can work out of? Also, what sort of attire should we expect to wear at the college?*

I will have a small room/office for you – equipped with 1 pc and a printer (are you bringing laptops?). Close by there is a physics lab, which is far from fully booked.

It can be hard to see any difference between Danish and American students, so don't worry about the dress code (we don't have any). Remember to bring warm clothes (lay by lay), especially a "wind breaker" (it's often windy) and something waterproof, and good shoes. The global warming has reached DK, too. Nevertheless it is still impossible to predict the weather. From March to May everything can happen.

*We are starting to put together the projects for the students next week. We are looking forward to our trip, and cannot wait to start working with you at IHK. We hope to hear back from you soon!*

All the same to you.  
Knud

**From: Knud Holm Hansen**  
**Sent: 12 February 2007 10:45**  
**To: [ihk@wpi.edu](mailto:ihk@wpi.edu)**  
**Subject: Re: Project Update**

Hi Jeremy

This is the good news from Lego – in Danish: "LEGO Education og Mikro Værkstedet vil gerne støtte jer med op til 5 sæt LEGO MINDSTORMS NXT (9797) til jeres projekt".

Translated it means something like: "LEGO will support your project with up to 5 kits".

At your first day at IHK we will take a picture of you and give you access cards to the building. You are welcome anytime – also during Easter. April 5, 6, 8, 9 are holidays (many of the shops are closed!) and if you are going to feel the Danish way of living you will enjoy it as an extended weekend. In schools (and IHK as well) it is a tradition that they are closed (i.e.: no lectures) during the "Easter period", which this year is March 31 – April 9.

All the best,  
Knud

**From: Lebowitz, Jeremy**  
**Sent: 20 February 2007 14:06**  
**To: Knud Holm Hansen**  
**Subject: WPI/IHK Project**

Hello again!

We were hoping that you could help us out with a few things prior to our arrival in Denmark. There were three very important issues that we need to address as soon as possible.

First, have any folkeskoles or gymnasiums (or teachers) expressed interest in the program so far? If not, do you think it would be possible to find at least one or two teachers from each school that would be interested in having us try out our projects with their classes? We are currently developing projects involving LEGO Mindstorms (for the gymnasium class), and projects involving windmills, catapults, bridges and bio-engineering for the folkeskole students). We would need one to two hours of class time each day for around a week or two to complete the

projects. If you could find teachers that would be willing to let us implement these projects it would be greatly appreciated. Our contact here that works at a gymnasium (Henrik Bang, you may have read about him on our website) said that he had a few of his colleagues interested, but we don't know how many exactly.

Next, we were wondering about a budget. Since IHK is sponsoring this project, we wanted to know how much funding we can expect from IHK. We are doing our best to design the projects such that it will be inexpensive to launch and continue the program. The cost of the projects would be minimal (if you need a number, maybe 300 kroner as a maximum for each class, but it will probably be much less than that). If we could find out what IHK will donate toward this cost now, it would be useful for our work in the coming few weeks.

Finally, we were considering assembling a "science fair" or a similar event where students who participate in our projects would be able to display their work. We would be targeting the students' parents, as well as IHK students and teachers, folkeskole and gymnasium students and teachers, etc. so that the projects can spread to other schools after the completion of our project in May. We were wondering if IHK had a facility to host this kind of event for around 100 students to display their projects, and any interested people to see what the projects are about. We would only need the space for 2-3 hours, preferably in the afternoon or early evening. Feel free to let us know your thoughts on this event, also.

Thank you very much for your continued contact. We look forward to hearing back from you.

Jeremy Lebowitz, Dan Murphy, Erin Yokay

**From: Knud Holm Hansen**  
**Sent: 22 February 2007 06:40**  
**To: [ihk@wpi.edu](mailto:ihk@wpi.edu)**  
**Subject: Re: WPI/IHK Project**

Hello!

1. We have met a general interest from the folkeskole-sector (in the local area), but have not so far made any more individual arrangements. I guess we need more detailed information about the projects, time-schedule, etc. before we can do that. My guess is – due to the fact that you are all English-speaking – that some folkeskole (and gymnasium) teachers will be very interested, because they can combine lessons in English, Science, and perhaps Math. Would you like me to establish some personal contacts before you arrive in DK – or can it wait? If I am going to do it, I probably have to go into details with schedules, i.e. you have to plan according to that afterwards.

2. At least 4x DKK 300 will not be a problem. Just remember that we normally need receipts for everything you buy. If you need/expect more money we'll find out (to some limit ...).

3. In fact we have a nice room for that type of event – It's called the "seminar room" (<http://www.ihk.dk/images/Lokaler%20på%20IHK/D%201.72%20Seminarrum.JPG>). The idea sounds great. The only problem I can see is that very few might attend – not because of lack of interest, more because of lack of time in the late afternoon and all the other things kids and parents are doing. However, IHK needs to be more visible, so let's continue the work with this idea. IHK will of course sponsor something to drink and eat during this session.

Kindest regards,

Knud

**From: Lebowitz, Jeremy**  
**Sent: 27 February 2007 18:00**  
**To: Knud Holm Hansen**  
**Subject: Re: WPI/IHK Project**

We sent this email to LEGO last Tuesday and have not yet received a reply. We were hoping that maybe if you sent LEGO something along the same lines they would respond to you and say when we could receive the LEGO kits. We have again updated our website, and on Thursday the final versions of the Powerpoint presentation and IQP Writeup will be posted on the "Files" page of our website.

<http://www.wpi.edu/~jlebo>

We have our schedule for our first week in Copenhagen (12 to 16 March), and from 13 to 16 March we will be having lunch at 12:30, and we are scheduled to meet you after lunch on Friday. We would love to meet you for lunch one of those days if you're interested. We look forward to coming to Denmark and meeting you soon!

---

**From: Lebowitz, Jeremy**  
**Sent: Tue 2/20/2007 8:08 AM**  
**To: torben.jessen@lego.com; kristian@mikrov.dk**  
**Subject: WPI/IHK Project**

Hello again!

We received word from Knud Hansen at IHK that LEGO has decided to sponsor our project. We are thrilled to hear this, and we appreciate LEGO's generosity! We are interested in receiving all five of the offered Mindstorms kits. We were wondering how we would be receiving the kits from LEGO. Will they be shipped to our work location at IHK, or will we have to pick them up from LEGO?

Also, we hope you've noticed the changes to the website (<http://www.wpi.edu/~jlebo>) since we've heard about the sponsorship. The LEGO logo (and link to the LEGO homepage) appears on every page of our website, and it also appears again on our Sponsors page with a description of the donation.

Again, we greatly appreciate the donation that LEGO has offered, and we look forward to hearing back from you.

Sincerely,  
Jeremy Lebowitz, Dan Murphy and Erin Yokay

**From: Knud Holm Hansen**  
**Sent: 1 March 2007 05:04**  
**To: [ihk@wpi.edu](mailto:ihk@wpi.edu)**  
**Subject: Re: WPI/IHK Project**



Hi all,

Lego has now responded that the kits will be sent to me at IHK during next week.

Four Export Engineering students have volunteered for the project, which means that you will have a good opportunity to brainstorm, plan, etc. with some Danish students – as well as learn more about Export Engineering. The four students are from the 4<sup>th</sup>, 5<sup>th</sup> and 8<sup>th</sup> semester (The program is nine semesters all-in-all) and will earn credits (elective course) for their work.

I am also trying to get in contact with interested teachers from folkeskole and gymnasium.

Your website is very nice. At the pages with project descriptions I think you should write “1.g” and “2.g” in stead of “10<sup>th</sup> Grade” and “11<sup>th</sup> Grade” under Gymnasium. In the Danish Gymnasium we use “1.g” as saying “first year of gymnasium”, “2.g” and “3.g”, not “Grade”. ”10<sup>th</sup> Grade” is actually an option in the folkeskole – typically for youngsters who need an extra year before continuing to the next level. You might also write “9<sup>th</sup>/10<sup>th</sup> Grade” under folkeskole instead of “9<sup>th</sup> Grade”.

Your lunch plans sound fine. I will, however, be rather busy your first week – except Tuesday when you arrive at IHK. Maybe we can arrange something in the evening that week – or the following? We can invite Prof. Zeugner to join us, and have dinner at a restaurant somewhere (IHK will pay, I guess).

Kind regards,  
Knud

## 6.8. *Interview with Yvonne Herguth, 21 March 2007*

This appendix contains notes from our interview with Yvonne Herguth, a student teacher at Børneuniversitetet.

- Teachers are always in the same school, Danish students have same teacher for 3+ years
- Private schools: more teacher-student interaction (even physically)
- Yvonne is a 9<sup>th</sup> grade teacher for math, science; her class is about 10 children; the basic math course she's teaching is now studying introduction to algebra; the science course is physics where they are covering electricity, Ohm's law, concepts of current
- **Methods to raise attractiveness to teachers:**
  - Ensure projects follow guidelines of education (which will be translated from Danish by Kresten)
  - Teachers love guidebooks explaining what's going on so they can understand subjects they may not be familiar with (background learning)
- There is a teacher at Børneuniversitetet who knows LEGO Mindstorms (offered as an elective subject grades 7-9 but only in some private schools)
- EXPORT ENGINEERING IS OFFERED AT 2 COLLEGES IN DENMARK
- Try out export engineering program at the private school (more open-ended)
- **Class hours are budgeted by subject** (there are a certain number of hours devoted to each subject, so these programs, if implemented, would require taking time from other subjects)
- Beginning of May: Grade 9 starts testing; currently they are catching up on material for tests
- Some teachers enjoy letting others take over the class, some would take over the lesson, teach in Danish, etc.
- Students would be happy to see new faces (with regard to teaching method for different grades)
- Keep students occupied to keep their attention throughout the program
- Some students would appreciate "storyline" and some would ignore it
- Recent TV program featured gigantic trebuchet (colleague at Experimentarium)
- Student English is good due to music, TV, etc. until it comes to technical terms—perhaps have pictures to describe any English terms to avoid confusion/ "I'm too stupid" mentality
- Student hesitance to speak English is declining (there is still the occasional resistant student)
- Most schools have A/V equipment available if teachers are made aware of the requirement in advance (have multiple versions available just in case—i.e. Powerpoint + handout)
- Also specify other equipment such as tables, etc. Most classrooms have multiple-student desks rather than single-student desks
- Maximum program cost of 50 kroner per student (anything under this cost will increase enthusiasm)

- **Large Do-It-Yourself shop for supplies in Norrebro called “Sylvain” but ask IHK teachers first because they can probably obtain supplies cheaper**
- Schedule meeting with Knud regarding picking up the program after we leave
- **Offer this project to teachers’ schools or offer for teachers from different schools to do the projects themselves (as continuing education)**
- Predominating feeling in Denmark that science/engineering fields are “really tough” and “only for boys”
- 8:30 to 2 is the average school day, *gymnasium* might end at 3
- Project Exhibition Day:
  - maybe 1/6 parent attendance in Copenhagen, **weekend** would be most successful (either Saturday or Sunday) or official school field trip (parents won’t go unless they’re off); better during the school day than after school during the week
  - Try a prize/contest to entice attendance: suggestions for prizes include science supplies (including possibly keeping their constructions), tickets to Experimentarium, pictures/poster of students with their creations for the school, trophies (something like FLL)
- **RECOMMENDATIONS: FUTURE PROJECT = IMPROVING PHYSICS/ SCIENCE ROOMS**
- Can give workbooks to Yvonne to review when finished before program implementation
- Write up a formal proposal to give to school/teachers
- Get a project mobile phone to encourage call backs from schools

## **6.9. Interviews with IHK Students, March 2007**

### **Questions:**

1. When did you decide to study engineering?
2. What caused you to choose engineering?
3. Did anyone in your childhood try to interest you in the subject?
4. Which type of *gymnasium* did you attend?
5. Do you recall any programs or classes that increased your interest or helped you to better understand engineering?
6. Do you feel there should be more effort made in the Danish school system to increase engineering awareness?
7. Would you be interested in participating in programs to bring engineering to the *folkeskole*?
8. How much of your time do you think you could devote to these programs?
9. Would you need any sort of compensation, in the form of wages or class credit, to be able to participate?

**Name: Nynne Christiansen**

**Major: Export Engineering**

**Semester: 5**

1. Year off after technical *gymnasium* to foreign aid, after that year
2. Chose IHK because of teaching method (smaller classes, more teacher interaction)
3. ---
4. Technical High School
5. not really (possibly summer camp style but not sure)
6. yes, public image is that engineering is too difficult and “i can’t do that” mentality, engineers can’t be creative/engineering is boring
7. yes, already is
8. only time on top of other classes
9. class credit

**Name: Johanne Sorensen**

**Major: Export Engineering**

**Semester: 4**

1. Second year in Brussels, engineering compared to business school
2. didn’t need technical background for export engineering (language only), then took math/physics
3. most women who pursue engineering had a father/brother already in the field
4. business high school
5. IHK has folkeskoles come here for 2 days to work with engineering
6. further education is only introduced at 7<sup>th</sup>/8<sup>th</sup> year
7. yes, already is
8. only time on top of other classes
9. class credit

**Name: Kresten Daugaard**  
**Major: Export Engineering**  
**Semester 5 and 8**

1. After trade school
  2. to work with technical and “softer” fields + developing
  3. father is civil engineer
  4. Business high school
  5. no
  6. yes, expand the science classes in *folkeskole + gymnasium*
  7. yes
  8. on top of full course load
  9. class credit
- Other: DTU is big campus for Danish standards

**Name: Dina Mathiasen**  
**Major: Export Engineering**  
**Semester 5**

**Hometown:**

1. Half a semester before starting school (has always thought about it)
2. Integration of different disciplines, business aspect
3. not at all
4. Roskilde, Vejle (regular *gymnasium*)
5. no
6. yes
7. yes
8. over and above normal course load
9. class credit

**Name: Simon Skov-Rasmussen**  
**Major: Electrical**  
**Semester: 3 sem.**

1. only a few semesters
2. always been a hobby
3. father is same field
4. technical *gymnasium*
5. only physics class
6. lack of engineers, would be a good idea
7. perhaps
8. 8 hours sounds reasonable
9. if had competence to explain necessary principles, would do it for free, otherwise credit/pay good

**Name: Maria**

**Field: Export Engineering**

**Semester: 5**

1. Took one year off to travel, before she left IHK/engineering was her second choice, when she returned, it was her first
2. It was the most reasonable thing to do
3. no
4. Regular, math
5. yes
6. yes
7. Yes, during 8-9 grade, there should be something to make students aware of what an engineer is (what they do, what jobs are available, etc.)
8. Little
9. Credit or payment would be helpful

**Name: Christian Holm**

**Field: I.T. and Communication**

**Semester: 5**

1. Young, early years of folkeskole
2. Always interested in electronics, etc.
3. No
4. Technical
5. Most teachers were engineers (in *gymnasium*)
6. Yes, especially an introduction to programming
7. yes
8. 1 full day a month
9. It wouldn't really make a difference in the amount of time available

**Name: Mella Pedersen**

**Field: Export Engineering**

**Semester: 5**

1. 3<sup>rd</sup> year of *gymnasium*
2. Chose export engineering because of the combination of language and engineering
3. Brother is an engineer
4. Regular, math
5. Physics in *gymnasium*
6. No, there is already a lot of science and math in the *gymnasium*
7. No
8. N/A
9. N/A

**Name: Henrik Jorgensen**

**Field: Technology Management**

**Semester: 9, masters**

1. Young, always interested
2. Just knew from early on that was the path to take
3. No
4. Regular, language
5. Nothing in particular, just math and science classes
6. Yes
7. If it didn't take up too much time
8. A few hours a month
9. Compensation wouldn't affect the amount of hours available

**Name: Sunna**

**Field: Export Engineering**

**Semester: 5**

1. When told about export engineering
2. Because of export engineering
3. Dad
4. Regular, math
5. The mathematics teachers in *gymnasium* made a difference
6. No, enough math already
7. Yes
8. Very few hours
9. Would need to receive class credit

### 6.10. *Interview with Experimentarium Employees, 26 March 2007*

This appendix contains a transcript of our interview with Per Velk, the head of development at the Experimentarium (a museum in Hellerup featuring hands-on science exhibits), and notes from an interview with John Toennersen, a “Pilot” (student-teacher who runs some programs at the Experimentarium).

Per Velk

Q: What are some different ways of teaching to involve children more, ways to make programs more interesting?

A: One of the big problems is that a good teacher is the best way to get children interested in the work, and there isn't much that can be done about that (it helps that IHK/WPI students are teaching our programs). Being more emotional as compared to the technical parts could help get female students interested in the fields. When his 2 daughters had to choose which school to go to, the technical *gymnasium* is 90% male, an environment which is very “nerdy.” It has changed now that you have to pick a direction (before it was only science or language) but today there are many ways to go. Within the science direction, currently it is more female than in the past (only in regular *gymnasium*, not in technical *gymnasium*). Danish and history are taught by regular *gymnasium* due to state mandates; other subjects are less emphasized, but there is more emphasis on multidisciplinary work now. (Physics and history, e.g. nuclear bomb and WW2, etc.)

There is a group of students who are very technical and have the drive to succeed in technical classes, and it's ok to be like that and it should be encouraged, but it's a minority. It is important that students can see the wider side of the “technical” fields. For him it's important to ask “why should we make the technology?” Answering the question would broaden the population who will find science and engineering interesting. That's the purpose of the Experimentarium, so that science is relevant to ordinary people. Of course it won't succeed every time, but that's how we try to think. If he tries to communicate energy, it is important that the population knows something about it, that a lot of people are able to develop new energy technology, but it's also important that the population are ready to decide what policies to go for. (Examples here are model power plant to use own physical strength to produce electricity. This example makes it easier to understand the output of a regular power plant. How many people on bicycles do we need to power Denmark?) **The big key is how to make these topics relevant to the public.** Getting the audience's context is important. The technology is not interesting so much as their life. Making exhibits interactive and forcing a user's input is effective in catching young people's attention (cell phones at Experimentarium).

Q: Do you have any recommendations for our programs?

A: It is tough to get *gymnasium* students here because they are too independent to come with their parents (maybe with their schools) but still need some advanced technical knowledge to take full advantage of the exhibits. Using Experimentarium tickets as prizes would be OK because students still have to pay to get in. Hands-on



examples (levers for trebuchet, etc.) work well. It's a big problem in folkeskole needs A LOT OF HELP with science experiments (0-6<sup>th</sup> year it's hopeless). In *gymnasium* the problem is not the lack of funding. LEGO Mindstorms is a rather male endeavor. It would be easy to make a robot run around just for fun rather than a goal. We'd have to think a little deeper to involve females. Some *folkeskoler* and *gymnasier* (experimentally) teach males and females completely separately. The theory could be that females might want to do programming of LEGOs, etc. but as long as there's a male around to do it he'd get to do it. The country would gain from having more females in engineering.

In the real world, people work in 3-4 person groups (not huge, seldom individually). 2 could be too few, 3 could have a "third wheel" dilemma, 4 person groups are quite common in *gymnasier*. Students in *gymnasium* are motivated enough to get work done. Talk to teachers about separating girls into all-girls groups (would work well in a competition where smartest/most aesthetically pleasing/etc. wins, not fastest/strongest) (also applicable to Export Engineering; perhaps try instead of a handicapped problem, a product that solves a problem that they personally have). Windmill project: have multimeter be a town where houses get lit up in sequence. Alternatively, have multiple windmill teams work together to solve problem (cooperation), as it might be more attractive to females.

Folkeskole: presentations in evenings...but if nobody shows up it's probably not our fault. (teacher behavior)

John Toennersen

- Stories greatly help the production of programs, but you have to read your audience to see if they are getting bored, then it's you doing a bad job
- Back stories might not be "scientific" but at least keep children interested/entertained (aliens exhaling something other than CO2)
- Windmill program: compare to cleanliness/efficiency to other energy sources

## **6.11. IQP Team Member Program Journals, 13-24 April 2007**

### **LEGO Mindstorms Program**

#### Teaching Notes:

- The entire class watches initial programming, not just the students who will do the initial programming
- Explain loops, switches
- Cover the “follow a line program”
- Have students plan the programming before beginning
- Each class needs a quick intro, including an objective statement for the daily goals
- Explain the view function before testing
- Talk more about the engineering process

#### Manual Notes:

- Note how many computers are necessary
- Note that a projector is needed in the same room as the computers and project
- Install software prior to class time
- Note desk space is needed
- If an IHK student is running the program, make sure they meet with the teacher prior to the first class. This will work out the kinks before class time
- Check if software works under student account
- Determine how the programs will be saved (under student account, USB drive, hard drive...)
- Storage Space necessary for the kits
- Transportation suggestions (how many people needed to help transport the kits to a new school)
- Set up the board and speakers before giving instructions
- Pass out survey before explaining the program
- Split into 5 groups
- 1 half of the group does programming, the other half does the building
- Charge batteries beforehand
- Have students break down robots afterward (cardboard sheets where to put items)

#### General Notes:

- Possibly bring IHK pens as advertisement
- No one in the class had ever done computer programming
- Students are really comfortable with LEGOS
- More help is needed for the programming
- Advertise IHK a bit more
- Building teams of 2-3 works fine
- Only a few students seemed disinterested (1-2 out of 26)
- All-female building groups made faster progress
- Have students save work often (power outage)
- Introduction and conclusion for each time period

## **Windmill Program**

### Class 1-

- Project covers levers, aerodynamics, electricity
- Possibly have the airfoil picture on the same slide as the basic mechanics slide
- Levers and rotation slide
  - Need to put much more detail on the slides so teachers can explain it
  - Teachers would definitely not know how to present the PowerPoint, or teach this material on their own
- Power Point a bit boring, maybe more real life examples?
- Discuss Engineering Process, emphasize planning
- Possibly create a student handout, maybe include
  - A place to draw up their plans
  - A clear goal statement
  - List of available materials
  - Instructions
    - Building only the top part of the windmill
    - Can cut any of the materials to the size they want
    - Do not have to use all the given materials
    - A time schedule
  - Design notes (tailfins?, where the magnets should go)
- Need a model or at least pictures, the students were very confused about the design. Once they had an idea of what it was supposed to look like, they came up with their own ideas, and made the designs even better
- Have drawings/plans approved
- Students work better in the workshop, as opposed to a regular classroom
- Materials List:
  - Cardboard
  - Paper plates
  - Sandpaper
  - Small, medium, large nails
  - Screws
  - Power drill
  - Drill bits
  - Magnets
  - Wire
  - Tape
  - List all wood and dimensions necessary

### Class 2-

- Need to discuss how the magnets work, before they do the design
- How the magnets need to be in orientation to the coil, the ends need to pass by
- Create coils beforehand!!!
- Bodil wants to use the program next year
- Find a windy spot beforehand

### **6.12. Interview with Martin Lidegaard, 14 March 2007**

This appendix contains notes from an interview with Martin Lidegaard, a member of the Danish Parliament with the Radikale Venstre party.

- In Denmark it is viewed as smarter to study social sciences or history than science or engineering.
- As a result, the science fields have high paying jobs.
- A few years ago, unemployment for engineers was high, this led to a student fear about the job market changing as the unemployment level is currently very low.
- Due to the current unemployment levels, Danish students just do what they enjoy.
- Regarding the Danish position in world affairs: Denmark is good at combining engineering with the “softer issues” vs. China who can produce two million engineers per year
- At 15 years old, it is too late to change a student’s mind about what field to go into
- There is a general lack of time in classes for the sciences, because of current state mandates for other subjects such as Danish, history, etc. there is nothing else to remove in the current school day for more science.
- However, there is abundant money available for research and careers in science and engineering.

### **6.13. Program Materials: Trebuchet Program**

This appendix contains the program materials for the Trebuchet program (*folkeskole* year 8). The first section is the teacher's manual, followed by the physics explanation sheet. The final page of the teacher's manual is a proprietary page stating the original authors and sponsors. This final page appears on all teachers' manuals as distributed, but has been omitted for the remaining five program teacher's manuals.

# Medieval Siege

An Engineering Experience in Mechanism Design

## Folkeskole Year 9

Project

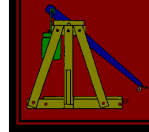

### MATERIALS / COSTS

(all costs given are estimates)



QTY	ITEM	COST
2.4m / group	Wood 2cmX4cm	31 kr / group
20 per group	Screws	25 kr / group
2x 2.5 kg	Weights	Free (IHK)
1	Trebuchet with projectiles	Free(IHK)
30 cm square/ group	Canvas	5kr/group
1 Spool	String	50kr
0.5m/ group	10mm metal rod	18 kr/m
1	Meter stick	Free
TOTAL COST PER PROJECT		50kr+ 70 kr / group

2-3x



6x



### TIMING BREAKDOWN

Preparation Time: 2-3 hours

Activity Time: 6 hours

### OBJECTIVE:

*Students will learn about simple machines as they construct a small working catapult.*

**Fields:** English, physics, woodworking

### Preparation:

1. Collect raw materials for construction.
2. Borrow demonstration models from IHK.

### Procedure:

1. Demonstrate the principles of levers, stored energy and projectile motion.
2. Define rules and describe kit of parts.
3. Student teams construct paper models.
4. Teams mark wood for drilling and sawing.
5. Teams assemble catapults.
6. Teams test catapults.

### Safety:

- Moving catapult arms
- Projectiles
- Wood splinters
- Use of saws and drills

# Medieval Siege

*An Engineering Experience in Mechanism Design*

Folkeskole Year 9

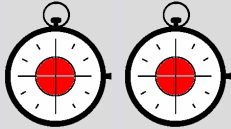
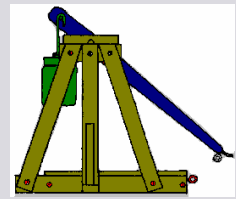

## Preparation

---

1. Purchase the materials on the cover page. Prices listed are those at Silvan (wood) or Kop&Kande (screws) and Stof 2000 (canvas) as of May 2007.
2. Separate the materials into kits for each group. A hacksaw is required for cutting the metal rod.
2. Pick up the demonstration materials from IHK. These include a completed trebuchet and weights.

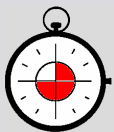

## Introduction

---

### Physics Introduction (45 min.)

Materials: Demonstration kits from IHK, Physics explanation sheets (you can give these sheets to students if you wish, or just use them yourself).

1. Describe the concept of levers. Relate force and speed.
2. Describe projectile motion. Focus on the significance of launch angles to distance traveled
3. Demonstrate the model catapult from IHK. Indicate significant design components. Demonstrate the advantage of the sling over the cup.
4. Show students the materials available to them and explain the rules:
  - The catapults will be judged for distance and accuracy in two tests.
  - Students may use the materials provided as they see fit, but do not need to use everything.
  - There are two weights for the class. Each group should only use one.
  - Students must draw their design carefully and have it checked by an instructor before they start building.

**Note:** If your students would enjoy it, you may introduce the project with the story of a medieval castle under siege.

# Medieval Siege

*An Engineering Experience in Mechanism Design*

Folkeskole Year 9

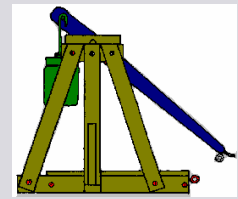

4-6 X

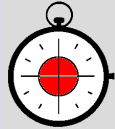

## Student Work

### Design Process: 30 min- 1 hour

Students will start by creating their design on paper. Be sure to mention that this is an important part of the design process and that real engineers always have full plans before they build anything. Let the students see the example catapult up close and help them to understand how every part works. Remember:

- Triangles are very strong shapes; squares need more screws and nails to keep their shape.
- The throwing end of the arm should move as quickly as possible.
- The angle of the hook controls the angle of release. They should be adjustable if possible. The hook should be made with a nail or other strong object. The bottle cap in the model was used to facilitate angle changing.
- Hanging weights put more energy into the projectile, because they do not put energy into rotating itself around the center.

As much as possible, encourage students to develop their own designs, and not just copy the example model. Suggest new designs for the bases which use less wood, so that the arm could be longer. A slide to help the sling move smoothly across the ground would also be a good idea. Challenge them to make something unique.

Once the students have completed their design, they should bring it to you for inspection. Make sure that they have not planned on using more material than they are allowed. Look also for parts that may be too small or weak and for shapes that will not be stable. Avoid saying exactly what is wrong; instead ask them questions to help them see their own mistakes.



# Medieval Siege

*An Engineering Experience in Mechanism Design*

## Folkeskole Year 9

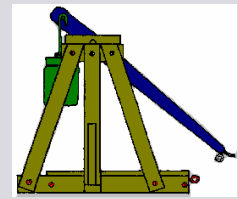

### Building: 3 – 5 hours

Allow the students time in a workshop to build their designs out of the listed supplies. If you wish, you may let them use more materials than we have listed, but if you wish to have the students compete, please ensure that all have an equal chance to get supplies.

While the students work, observe them and try to help them follow their own designs. Continue looking for mistakes in the designs, so that they may be corrected early.

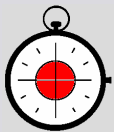

### Testing

---

Testing will take place in three steps and will determine the quality of the trebuchets. Try to use either a level field outside or a large indoor space. If the trebuchets are firing farther than your tape-measure, try marking a spool of string at half or quarter meter increments.

**Free Testing (30 minutes):** Allow the students to take turns using the provided weights to fire their trebuchets. This will help them find any remaining design flaws and correct them. Remind them to adjust the position of the firing hook to achieve the best launch angles. Only two groups will be able to test at a time, so you should ensure that each group has a chance to use a weight.

**Distance Testing (20 min):** This is the first formal test of the trebuchets. Let each group fire their trebuchet three times and measure the distance to the first place on the ground that the projectile hits. Record the best distance of each. Failed firings should count against the three shots allowed (a well built trebuchet should fire every time).

# Medieval Siege

*An Engineering Experience in Mechanism Design*

## Folkeskole Year 9

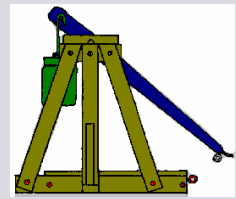

**Accuracy Testing (20 min):** This test will determine the stability and repeatability of the trebuchets. Remind the students that precision is just as important as raw power in engineering. Mark a spot at one end of the field with tape or a rock and challenge the students to hit it with their trebuchets. They may place their trebuchets anywhere this more than two meters from the target. Allow three shots to each group, as before. Measure distance from the target to the projectile and record the best result of each group.

**Assign points:** If you wish for this to be a competitive project, then you may assign points for the accuracy and distance testing results. We recommend the following system.

- For distance: groups get one point for every group that they outperformed. For six groups the shortest throw would get 0 points and the farthest would get 5 points. An optional extra point may be given to the farthest throw if they have thrown more than 125% of their nearest competitor.
- For accuracy: groups get one point for every group that they have outperformed. There is an optional point awarded if the winner has directly hit the target.

# Medieval Siege

*An Engineering Experience in Mechanism Design*

## Folkeskole Year 9

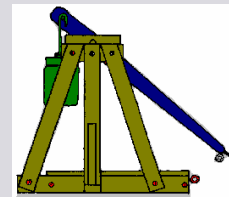

### Debriefing

---

Please collect the weights and projectiles from the students for return to IHK.

Discuss with the students their experience. What parts of the program did they enjoy? Did they understand all of the physics concepts? Was it easier or more difficult than they expected? Did they enjoy the experience?

Mechanical engineers perform many of the same tasks that the students did for this project. They were given a basic understanding of physics and asked to use that understanding to solve a problem. They had to plan carefully, to be sure that they used the available materials to the greatest effect possible. They built and tested their machines and used their observations to adjust their designs. At the end their designs were evaluated for power and precision.

Discuss with the students how engineers affect the world. What everyday objects are designed by engineers (toothbrushes, TVs, cars and anything that is mass produced)?

This booklet is © 2007 Worcester Polytechnic Institute in conjunction with Ingeniørhøjskolen i København.

The original authors are  
Jeremy Lebowitz  
Dan Murphy  
Erin Yokay

For more information about this project, please contact Knud Holm Hansen at IHK at [khh@ihk.dk](mailto:khh@ihk.dk).

Please e-mail us at [ihk@wpi.edu](mailto:ihk@wpi.edu) if you use this project.



## The Physics of Trebuchets

**Levers:** If an object is free to rotate about one point, it is possible to cause rotation by applying a force that is not in line with that point. Consider the following diagram

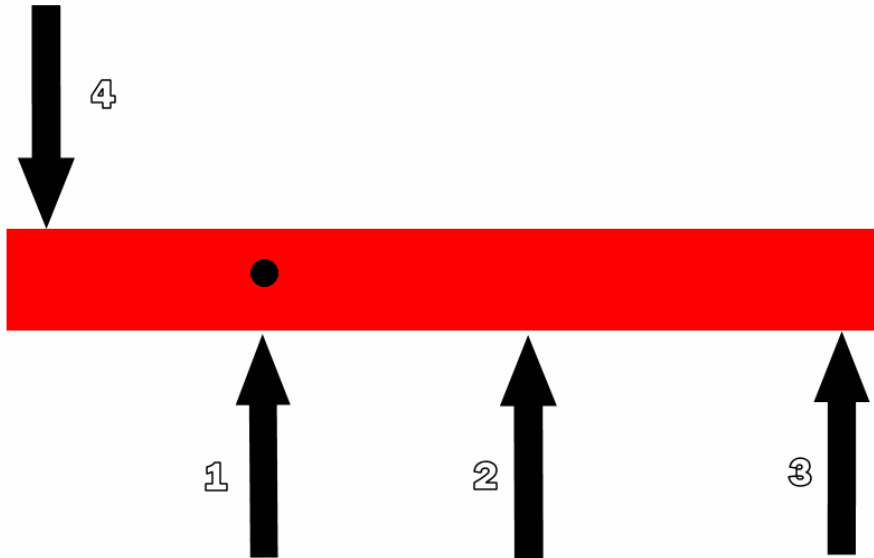

We see a solid bar, with a fixed point of rotation and four possible forces acting upon it. Each force is equal, but each causes a different amount of rotation on the bar.

Force 1: This force is directed at the point of rotation. It will cause no rotation.

Force 2: This force is in the same direction as force 1, but is shifted to the side. This will cause the bar to start rotating in the counter-clockwise direction.

Force 3: This force is like force 2, but is even farther from the center of rotation. It will cause rotation in the same direction as with force 2, but at greater speed.

Force 4: This force is directed in the direction opposite the other three, but it is also on the opposite side of the center of rotation. It will cause motion in the same direction as 2 and 3.

It is also important to note that for a given rate of rotation, total velocity increases with distance from the point of rotation. For trebuchets this means that the projectile will have the highest speed if the throwing end of the arm is as long as possible. The weight may be fairly close to the center of rotation, because it weighs much more than the arm and the projectile.

**Projectile Motion:** The distance that a projectile will travel before hitting the ground can be determined from its speed and angle of launch. Consider the projectile as having vertical and horizontal speed. The vertical speed determines how high the projectile will fly and the amount of time before it returns to the ground. The horizontal speed determines how much ground the projectile will cover during the time that it is flying. With small angles of launch, most of the velocity will be horizontal. In this case, the projectile will cover ground very quickly, but will only be in the air for a short time. If the projectile is launched at a very steep angle, it will fly for a long time, but travel over the ground very slowly. The ideal launch angle is 45 degrees, which gives an ideal mix of air time and horizontal speed.

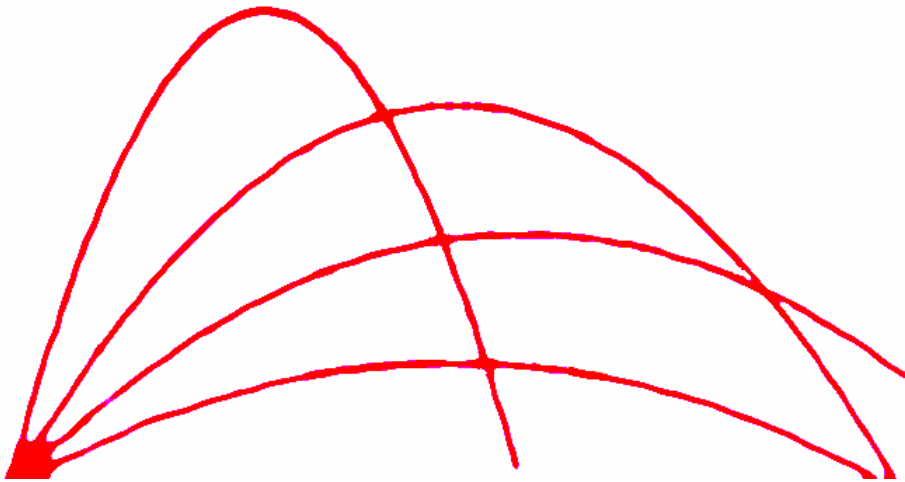

#### **6.14. *Program Materials: Windmill Program***

The following pages contain the program materials for the Windmill program (*folkeskole* year 9). The first section is the teacher's manual. The following page is a handout for students regarding the social impact of windmills. The final handout is the physics explanation for windmills.

# Wind Power

An Engineering Experience with  
Electronics, Mechanics and Physics

## Folkeskole Year 9



### MATERIALS / COSTS

(All costs given are estimates)



QTY	ITEM	COST
1.5m/ group	Angled lumber	27 kr/m
0.6m/ group	115mmX14mm	50 kr/m
0.2m/ group	100mmX50mm	Use school supply
1m/ group	Wood, 9mmX9mm	8 kr/m
0.3m/ group	22mm round	14.25 kr/m
1 or 2/ group	Magnets	IHK
20m/ group	.18 mm copper wire (enameled)	IHK
1	Multimeter	IHK
TOTAL COST PER PROJECT		Depends on school



### TIMING BREAKDOWN

**Preparation Time: 3 hours**

**Activity Time: 6 hours**

### **OBJECTIVE:**

*Students will build a working wind turbine that will generate electricity.*

**Fields:** English, Electricity, physics, mechanics

### **Preparation:**

1. Borrow supplies from IHK
2. Purchase and pre-cut all needed lumber.
3. Prepare the workshop for students.

### **Procedure:**

1. Introduce students to basic physics principles.
2. Introduce students to project goal, break class into groups of 4-5 students.
3. Groups submit designs for approval.
4. Groups build their turbines.
5. Turbines are tested
6. Discussion and wrap-up.

### **Safety:**

- Sharp tools
- Spinning turbines

Lego Man image courtesy of [www.pixeljoint.com](http://www.pixeljoint.com)



# Wind Power

An Engineering Experience *with Electronics, Mechanics and Physics*

## Folkeskole Year 9

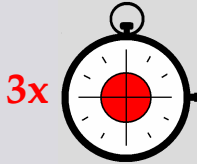

3x

### Preparation

---

1. Borrow the supplies from IHK. These should include: many small flat magnets, a spool of wire, one demonstration wind turbine, a tower for the turbines and a multimeter. If there are other magnets available at your school, they should be offered to the students, to give students more design options.
2. Purchase and cut the listed sets of lumber for student use. The two most important pieces are the angled lumber (see the blades of the example turbine for reference) and the round rod. Other pieces may be substituted or added as instructors see fit, but be sure that students will have enough material to be creative. If possible, you may use wood from your school to reduce costs.
3. Ensure that the school workshop has tools and a selection of nails and screws. There should be many saws and hammers (1 per group or more) and at least one drill. Any other common school supplies (e.g. glue, rubber bands, card board etc.) that can be found easily should be made available.
4. If necessary, read the physics explanation sheet and be ready to answer student questions.

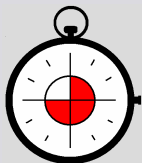

### Introduction

---

#### **Introduction to Project Goal (15 minutes)**

Explain the goal of the project to the students and show them the materials that they will have available. Show them the example wind turbine to give them a general idea of what to build, but strongly encourage them to think for themselves and develop their own designs.

# Wind Power

An Engineering Experience *with Electronics, Mechanics and Physics*

## Folkeskole Year 9



### Physics Introduction (Hand out the physics explanation sheets if necessary)

1. Explain the idea of an airfoil and explain how they are used in wind turbines. Point out the similarity between the shape of an airfoil and the angled lumber. Be sure that students understand that the wind needs to hit the blade at an angle for a reaction to occur.
2. Explain the idea of a lever. Discuss the idea of a wind turbine blade as a lever. Explain that longer blades will provide more torque, because they apply force farther from the center of rotation.
3. Explain the principle of electromagnetic induction. Be sure that students understand that the change in the magnetic field is more important than the total strength. Students should understand that in order the field strength to change, that the magnet must either change its total distance from the coil OR change its north-south orientation.

4-6x

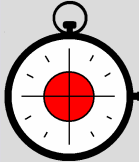

### Student Work

---

#### Design Process (30 min- 1 hour)

Students will start by creating their design on paper. Be sure to mention that this is an important part of the design process and that real engineers always have full plans before they build anything. Let the students see the example wind turbine up close and help them to understand how every part works. Be sure that the students understand that they will be putting the turbine on the provided tower. They only need to build the blades and the generator.

As much as possible, encourage students to develop their own designs, and not just copy the example model. Suggest that new designs might prove to be more stable or less likely to break. The students should especially consider how they will attach the blades to the shaft. They need to plan the

# Wind Power

An Engineering Experience *with Electronics, Mechanics and Physics*

## Folkeskole Year 9



shape and the method of assembly. Challenge them to make something unique. Once the students have completed their design, they should bring it to you for inspection. Make sure that they have not planned on using more material than they are allowed. Look also for parts that may be too small or weak and for shapes that will not be stable. Avoid saying exactly what is wrong with any given design; instead ask questions to help students see their own mistakes.

### **Building (3- 5 hours):**

Allow the students time in a workshop to build their designs out of the listed supplies. If you wish, you may let them use more materials than we have listed, but if you wish to have the students compete, please ensure that all have an equal chance to get supplies.

While the students work, observe them and try to help them follow their own designs. Continue looking for mistakes in the designs, so that they may be corrected early.

To make the wire coils: place a wooden pencil along the side of a piece of wood and begin wrapping the wire around both at the same time. Leave about 10 cm of extra wire free at either end of the coil. Allow the students to make the coils as large as they like (use the example turbine for reference). The wire can be cut with pliers, scissors or by putting it in a flame and pulling. To remove the coil from the wood, pull the pencil out and the coil should slide off easily. Immediately wrap tape around the completed coil or it may come loose. When the coils are done, use a lighter to burn the enamel off of the last few centimeters of both of the free ends of the wire. This will ensure good electrical connections. Test each coil by attaching it to the multimeter (set to voltage) and moving a magnet past or through it. If the coil fails testing, set the multimeter to read resistance ( $\Omega$ ). If the coil is more than approximately 100  $\Omega$ , try burning the ends of the wire again. High readings (M  $\Omega$ s) indicate that the coil is probably broken and should not be used.

# Wind Power

An Engineering Experience *with Electronics, Mechanics and Physics*

## Folkeskole Year 9

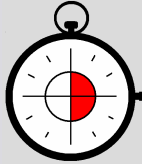

### Testing

---

As students near completion of construction, attach the multimeter to student turbines and have them spin the wind turbines by hand. They should cause readings of 2-15 mV. To achieve best results, the magnet should come as close as possible to the coil without getting caught. Adding a layer of paper over the coil may help keep moving parts from catching.

Once all groups have proven that their turbines will generate power, it is time to begin actual testing. Move the class outside and set the tower in a location that has strong, but consistent wind. Higher locations are usually better and locations far from trees and buildings are preferable.

Have each group place their turbine on the tower and measure the voltage reading for a minute or more and watch for the peak reading and record it.

If the turbines are not functioning well in low wind conditions, students may wish to add cardboard panels to increase the area of the blades. Cardboard attached to the outer third of the blades will provide the greatest amount of torque, with returns diminishing as more cardboard is added closer to the center.

# Wind Power

An Engineering Experience *with Electronics, Mechanics and Physics*

## Folkeskole Year 9

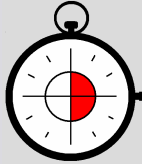

### Debriefing

---

After testing is complete, please collect any borrowed magnets from the students.

Discuss with the students their experience. What parts of the program did they enjoy? Did they understand all of the physics concepts? Was it easier or more difficult than they expected? Did they enjoy the experience?

Mechanical engineers perform many of the same tasks that the students did for this project. They were given a basic understanding of physics and were asked to use that understanding to solve a problem. They had to plan carefully to ensure that they used the available materials to the greatest effect possible. They built and tested their machines and used observations to adjust their designs. At the end, their designs were evaluated for power and precision.

Discuss with the students how engineers affect the world. What everyday objects are designed by engineers (toothbrushes, TVs, cars and anything that is mass produced)? Why is wind power important to environment? What sources of clean power are available? Mention that Denmark is a world leader in the production of wind turbines.

# WIND ENERGY AND THE ENVIRONMENT



## **INTRO: FOSSIL FUELS & RENEWABLE ENERGY**

Currently the world's main energy resource is fossil fuel. Eventually fossil fuel will run out and thus, renewable energy will be essential. The current predictions on how long certain fossil fuels will last before we use them up are as follows:

<b><i>Fossil Fuel</i></b>	<b><i>How Long It Will Last*</i></b> <i>(what year it will run out)</i>
Oil	2096
Natural Gas	2165
Coal	2217

Renewable energy, on the other hand, is based on natural resources that occur continually:

- Sunlight
- Wind
- Water

These resources can be referred to as “green” or “clean” energy because they do not pollute the air or water. Fossil fuels should not only be replaced due to a shortage, but because they cause a huge amount of damage to the earth through pollution. The gases emitted from this form of energy production create the greenhouse gases causing global warming. Renewable energy is a solution to this problem.

## **WIND ENERGY:**

### ADVANTAGES-

- uses no fuel
- does not produce any air pollution
- does not create greenhouse gases
- does not disturb nature
  - wind turbines can be placed above tree lines
  - new designs decrease the number of birds affected

### DISADVANTAGES-

- wind energy is intermittent, so other forms of energy are needed for backup on calm days
- height can be a safety hazard for low-altitude aircraft
- offshore towers can affect nautical navigation

\*Source: [http://www.missmaggie.org/mission2\\_parts/eng/teaching/reallybig.html](http://www.missmaggie.org/mission2_parts/eng/teaching/reallybig.html)

## The Physics of Wind Power

**Airfoils:** Airfoils are objects which redirect the flow of air in order to produce forces in directions perpendicular to the flow of air. Airplane wings, sails on ships and blades on wind turbines are all airfoils.

Airfoils work under the law of inertia and the law of reciprocal actions. According to the law of inertia, in order for a moving mass to change its direction of motion or velocity a force must act upon it. Air foils produce forces which cause air flow to change direction. According to the law of reciprocal actions, if an airfoil exerts a force upon the flow of air, then the air exerts an equal and opposite force on the airfoil. In airplane wings, the airfoils direct the flow of air downward and in response, the air pushes the wing upwards. In wind turbines, the blades push the air flow away from the direction of rotation and are themselves pushed in the direction of rotation

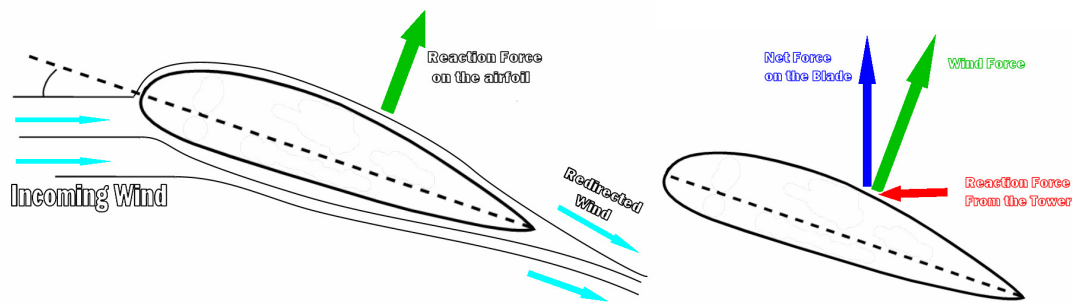

An airfoil redirecting wind

Sum of the forces on a blade

**Electromagnetic Induction:** Electricity is generated by a process known as electromagnetic induction. When a charged particle, such as an electron, is exposed to a changing magnetic field, the particle experiences a force in a direction perpendicular to the field. If a metal wire is exposed to a changing magnetic field, the force upon the electrons in it will produce a voltage across it. If the wire is part of a complete electric circuit, then the electrons will flow through it. This is electricity.

To create the changing magnetic field with the mechanical energy of the windmill one need only move a permanent magnet relative to a coil of wire. One may either move the coil closer to and farther from the center of the coil, or one may rotate the magnet so that the north and south poles change direction. (Be sure to keep magnets away from sensitive electronics!)

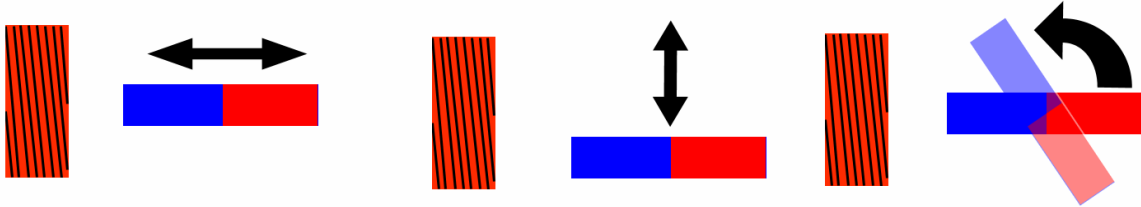

**Levers:** If an object is free to rotate about one point, it is possible to cause rotation by applying a force that is not in line with that point. Consider the following diagram

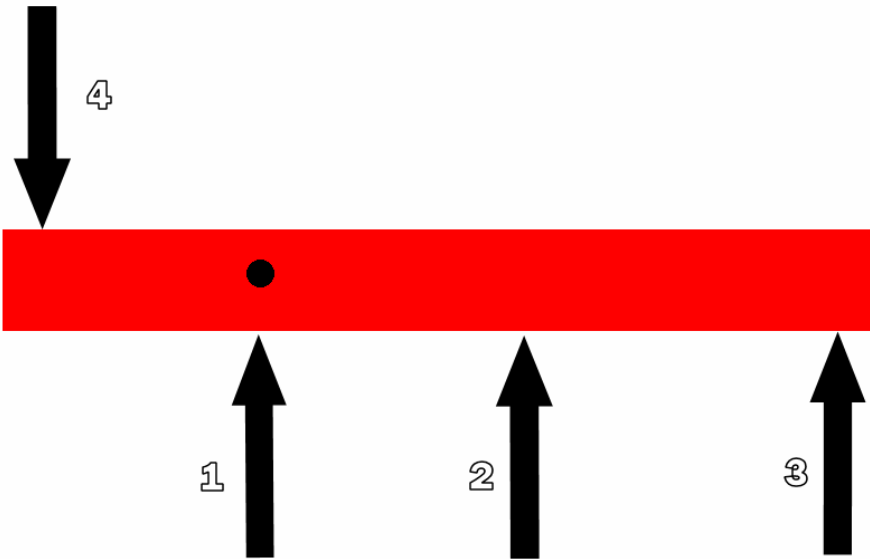

We see a solid bar, with a fixed point of rotation and four possible forces acting upon it. Each force is equal, but each causes a different amount of rotation on the bar.

Force 1: This force is directed at the point of rotation. It will cause no rotation.

Force 2: This force is in the same direction as force 1, but is shifted to the side. This will cause the bar to start rotating in the counter-clockwise direction.

Force 3: This force is like force 2, but is even farther from the center of rotation. It will cause rotation in the same direction as with force 2, but at greater speed.

Force 4: This force is directed in the direction opposite the other three, but it is also on the opposite side of the center of rotation. It will cause motion in the same direction as 2 and 3.

An understanding of levers is important to wind turbine design, because each blade is a lever. One can assume that each point along the blade is experiencing an equal force, due to the wind, but that force creates more turning power at the farthest ends of the blades. The outer half of a



blade produces 3 times more turning power than the inner half. Students should try to use a few long blades, rather than many short ones. Also, if they choose to widen the blades with cardboard, they will see the most benefit if they widen the ends of the blades, rather than the parts near the center.

**6.15. Program Materials: Bridge Program**

This appendix contains materials for the bridge program (*folkeskole* year 9). The first section is the teacher's guide, followed by the student manual.

# Bridge Design Project

An Engineering Experience with structural engineering and budgeting

Folkeskole 9

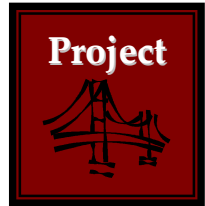

## MATERIALS / COSTS

(all costs given are estimates)



QTY	ITEM	COST
	Kit of parts	See Materials Sheet
1	Scale	At school
1	Toy Car	3 for 20 kr
	Internet (for research)	-
<b>TOTAL COST PER PROJECT</b>		Variable



## TIMING BREAKDOWN

Preparation Time: 2 hrs.

Activity Time: 6-8 hrs.

## OBJECTIVE

Students will be able to implement structural principles by designing and constructing a model bridge. The students will also illustrate an understanding of budgeting by buying supplies for the bridge construction given a set amount of “money”. The best bridge can hold the most weight for the lowest cost.

**Fields:** English, Physics, Math, creative problem solving, teamwork, understanding economic goals

## Preparation:

Gather listed supplies according to class size.

## Procedure:

1. Introduce students to bridge design through lessons on structural principles.
2. Introduce students to project goal, break class into groups of 3-4 students.
3. Groups are introduced to material costs and group budgets.
4. Groups design bridges.
5. Groups purchase necessary supplies.
6. Groups build and test bridges.
7. Discussion and wrap-up.

## Safety:

- Hot glue gun, cutting tools

# Bridge Design Project

An Engineering Experience with structural engineering and budgeting

Folkeskole Year 9

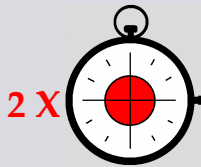

## Preparation

Considering each class size is different, preparation for the kit of parts varies:

- You may be creative with the kit of parts, including anything that would allow for the students to construct a tangible product.

### Suggested materials:

- **Structure:** popsicle sticks, straws, pastas (such as spaghetti and fettucine), string, foam core board, cardboard, printing paper
  - **Assembly:** hot glue gun/glue sticks, regular glue, duct tape, masking tape, cellophane tape, stapler and staples, paper clips
  - **Decoration:** markers
- It is important to consider how much of each material is necessary before purchasing the kit of parts. Popsicle sticks, straws, and pasta will be needed in the highest quantities.
  - When the kit of supplies has been purchased, the items need to be “priced.” This will allow the students to purchase the needed supplies for their bridge and learn about budgeting (the following page includes an example price sheet).
  - Testing the bridges: place a block of wood or other sturdy, flat surface at the center of the bridge. Then, using objects of predefined weight, keep adding weight to the bridge until it collapses, then add up the amount of weight the bridge was able to support.
  - A toy car can be used to see how realistic the bridge is for scale-up.
  - Set up an area for bridge testing. Have a gap of about 75 cm, with a flat surface for support columns 20-25 cm below the gap.

# Bridge Design Project

*An Engineering Experience with structural engineering and budgeting*

## Folkeskole Year 9



### Example Price List

---

Feel free to modify this list based on the materials used. This guide is a rough estimate based on the quantities of materials that would be needed to build a bridge as part of this program.

Material:	Price per unit:
1 hot glue stick & use of hot glue gun	1000
1 bottle of glue	750
1 A4 sheet of heavy paper	200
1 A4 sheet of printer paper	125
1 cm of cellophane tape	2
1 cm of masking tape	4
1 cm of duct tape	6
1 cm <sup>2</sup> of foam core board	10
1 popsicle stick	20
1 straw	10
1 cm of string	1
1 paper clip	5
Pasta (spaghetti)	1
Pasta (fettucine)	3

# Bridge Design Project

An Engineering Experience with structural engineering and budgeting

Folkeskole Year 9

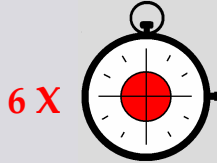

## Project Description

**Game Objective:** The team of students who builds the bridge that can hold the most weight for the least amount of money spent. (weight : cost)

1. **Hour 1:** Split the students into 5 groups or "Engineering Teams" ( 4-5 per group)
2. Distribute the Student Manuals. Review the manuals with the students and discuss the goals of this project.
3. Discuss different bridge types. Have students research the topic more thoroughly. After their research have them decide what type of bridge they will be constructing.
4. **Hour 2-3:** Next, students should develop a basic design with preliminary sketches.
5. After preliminary planning students will then use their technical drawing sheets to make the complete drawings of their bridge design. They will also fill out their Bill of Materials sheet (to indicate material that they intend to use).
6. Examine each design before construction starts. Looks for any obvious flaws that may weaken the structure and help the students to develop solutions
7. To save time, allow students full access to all materials, with the understanding that they must maintain a complete list of materials taken and used.
8. **Hour 4-5:** Students will then construct their bridges.
9. After all students have finished construction, wait until the next day to test (this will allow glue to set).
10. Visually inspect the bridge and compare it to the Bill of Materials. Ensure that the students have recorded all of the materials used.
11. **Hour 6:** Test 1: Measure the bridges. They must span a 75cm gap and be at least 15cm wide.
12. Test 2: Push a toy car across the bridge. The car must pass smoothly and without catching.
13. Test 3: Apply weight to the center of the bridge in small increments. Record the greatest weight that each bridge is able to support without breaking.
14. When all the students have finished testing their bridges, have them calculate their weight to cost ratios in their Student Manuals. Declare the group with the highest ratio to be the winner of the competition.

# Bridge Design Project

*An Engineering Experience with structural engineering and budgeting*

## Folkeskole Year 9



### Student Instructions

---

(This is the instruction set the students receive)

**Problem Statement:** Your engineering team has been asked to build a new bridge for a small island off the coast of Denmark. A lot of heavy vehicles need to reach this island to deliver supplies, so the bridge must hold as much weight as possible. The main concern for this small island town is that it is on a budget. They need the strongest bridge for the smallest amount of money possible. Build a small scale bridge to prove to the town that they should choose your design. The team with the strongest bridge compared to the budget spent on construction (the ratio of weight that the bridge will hold to cost of the bridge) will be chosen as the head engineers.

#### Design Rules:

You will be divided yourselves into groups of four or five. You must research a variety of bridge types and then design and build a bridge to meet the following criteria:

- It must span the 75 cm gap.
- It should be at least 10 cm wide.
- It must be able to support as much weight as possible at the center.
- A toy car must not fall through the roadway surface of the bridge.
- All materials purchased, even if not used in the construction of the bridge, must be added to the total cost of the bridge

# Bridge Design Project

*An Engineering Experience with structural engineering and budgeting*

## Folkeskole Year 9

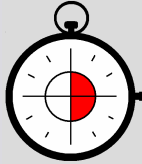

### Debriefing

---

After bridge testing, wrap up the lesson with a few discussion questions so that the students can put together all the information they that have been given.

- What could have been done differently to decrease the budget?
- Where were the main structural flaws when the bridges broke?
- What was the best type of bridge to be used in this project?
- Describe situations where each bridge type would be a good choice.
- Girder: short spans, light loads, pedestrians
- Arch: medium spans, medium loads, over valleys or deep rivers
- Truss: short spans, heavy loads
- Cable-stayed: long spans, medium loads, car traffic
- Suspension: long spans, heavy loads, ships passing underneath

Structural and civil engineers perform many of the same tasks that the students did for this project. They were given a basic understanding of physics and were asked to use that understanding to solve a problem. They had to plan carefully to ensure that they used the available materials to the greatest effect possible. They built and tested their bridges and used observations to adjust their designs. At the end, their designs were evaluated for economy and strength.

Discuss with the students how structural engineers affect the world. What everyday objects are designed by engineers (buildings, bridges, sewage systems, etc.)?



## MATERIALS SHEET

### Average Cost Of Materials

<b>Item</b>	<b>Amount</b>	<b>Cost (in Kr)</b> Based on prices found at a variety of stores around CPH
Spaghetti	1000 grams	5
Heavy Paper	1 sheet (46x64 cm)	6
String	15 meters	13
Foam Core Board	1 sheet (46x64 cm)	20
Straws	100	20
Bottle of Glue	1	20
Popsicle Sticks	100	30
Paper Clips	100	45
Duct Tape	1 roll	50
Hot Glue Gun	1	50
Hot Glue Sticks	15	20
Stapler	1	50
Staples	1000	15
Markers	20	100

### Average Amount Of Material

(Reusable Items not Included)

**90 kr/group or 23 kr/student**

<b>Item</b>	<b>Amount per Group</b> (groups won't necessarily use all of these materials but amounts are recommended)
Spaghetti	1000 grams
Heavy Paper	1 sheet (46x64 cm)
String	2 meters
Foam Core Board	1 sheet (46x64 cm)
Straws	100
Bottle of Glue	1
Popsicle Sticks	100
Paper Clips	10
Duct Tape	1 m
Hot Glue Sticks	5
Staples	30

# BRIDGE DESIGN PROJECT

*An Engineering Experience with structural  
principles and budgeting*



Engineers:

## ENGINEERING PROCESS

**Problem Statement:** Your engineering team has been asked to build a new bridge for a small island off the coast of Denmark. A lot of heavy vehicles need to reach this island to deliver supplies, so the bridge must hold as much weight as possible. The main concern for this small island town is that it is on a budget. They need the strongest bridge for the lowest amount of money as possible. Build a small scale bridge to prove to the town that they should choose your design. The team with the strongest bridge compared to the budget spent on construction (the ratio of weight the bridge holds to kroner spent) will be chosen as the head engineers.

### **Design Rules:**

Divide yourselves into groups of four. After researching bridge design, you will design and build a bridge to meet the following criteria:

- It must span a 75 cm gap
- It must be 15 cm wide
- It must be able to support as much weight as possible at the center.
- A toy car must not fall through the roadway surface of the bridge

**Note:** You must pick what type of bridge you are designing and sketch that bridge. Working as a group, be sure to pay particular attention to sketching your bridge, as this is an important aspect of the engineering process.

## STRESSES AND STRAINS

The bridge you design will be subject to the force of the weight on it. This force is known as “stress” on the bridge, and causes the material of the bridge to experience a “strain.” A good bridge distributes the weight to more stable sections, such as firmly planted towers or supports that are in the ground. This section contains explanations of the different forces that occur when a load is placed on a bridge, and some tips to avoid problems when designing and building the bridge. The next section contains five different bridge types, and the way the designs allow for the spreading of forces to make a stable method for holding weight.

### Compression and Tension

Depending on the way your bridge is designed, certain portions will be affected by forces known as COMPRESSION and TENSION. Compression is a force that pushes an object in on itself, and tension is a force that stretches an object out. The right-hand diagrams for each bridge type show which parts of the bridge are subject to which forces. Tension forces are shown by the green arrows and compression forces are shown by red arrows. Some materials are stronger in one form of stress than they are in the other.

What materials in your list of parts would be good at withstanding compression? Is a piece of string or a piece of spaghetti better at withstanding tension? Consider questions like these when you choose which materials to make each part of your bridge.

### Shear Forces

The span of your bridge is longer than any one building material you can purchase. You must attach pieces to one another in some manner. This process introduces a possible weakness into your bridge where the materials are connected.

Suppose you attach two pieces of wood with glue to make a longer piece of wood.



Now look at some ways forces can be applied to the joined pieces. If the joined part experiences a compressive force, nothing will happen.

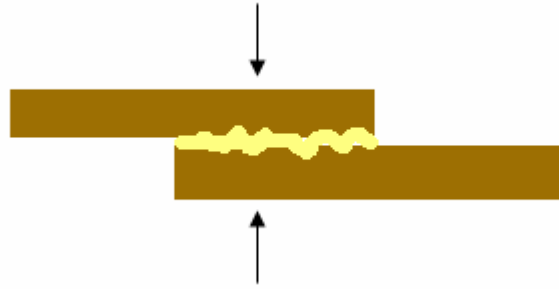

However, if a horizontal force is applied, the joint may fall apart. This force is known as “shear.”

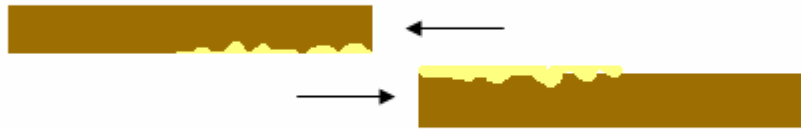

You must consider which direction the weight applied to the bridge will affect the material, and design a bridge that minimizes weak points where the weight can cause the bridge to break.

## Bending

When a long unsupported beam is subjected to weight at one point, it bends. This occurs because the upper half of the beam is being compressed, while the lower half of the beam is under tension. This force is a problem because many solid materials fail under tension. This stress can be lessened by decreasing the distance from the load to the nearest support structure, thus distributing the force of the weight to other segments of the bridge.

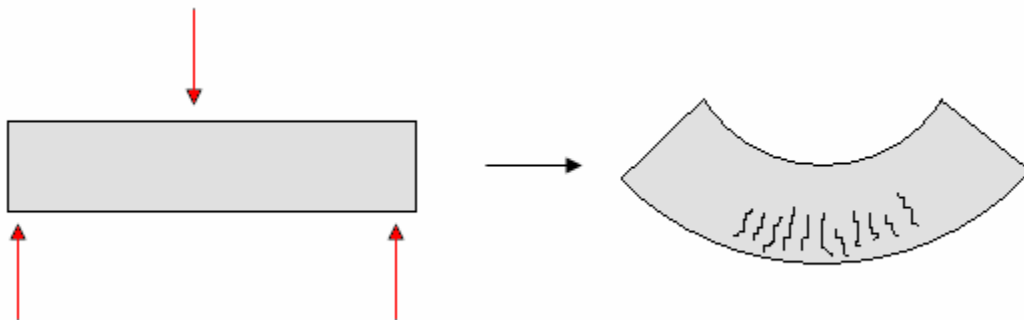

## Construction tips

Two very strong shapes in architecture are the circle and the triangle. If possible, try and incorporate these shapes into your design. For example, a support that reaches from the bridge to the ground might be made of a rolled up piece of paper. You might also consider the truss bridge, which takes its strength from the triangle.

Take a look at what happens when forces are applied to a square rather than a triangle:

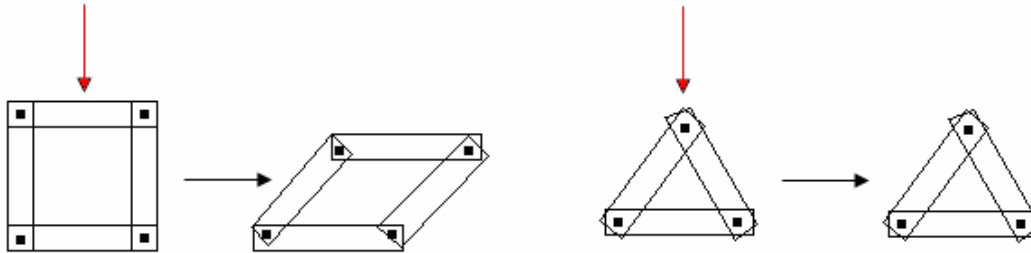

If the force is applied to the top of the square, it can deform. The triangle does not have this property, as the sides distribute the weight evenly to the base.

You should consider the properties each material has when deciding which type of bridge to build. Does the bridge require materials that are strong in compression? Shear? Tension? Which are the best materials to use for each purpose?

## BRIDGE TYPES

### Girder Bridge

A girder bridge is a very simple type of bridge and can be built with any long, straight material. The problem with this bridge type is that there is no method to distribute the load and the bridge integrity is entirely dependent on the bending strength of the material. In the figure at right, the top portion of the bridge is compressed (shown by red arrows), and the bottom portion is tensioned (shown by green arrows). The bridge wants to bend down toward the water in the middle. Although easy and inexpensive to construct, this type of bridge cannot support a large amount of weight or span very far.

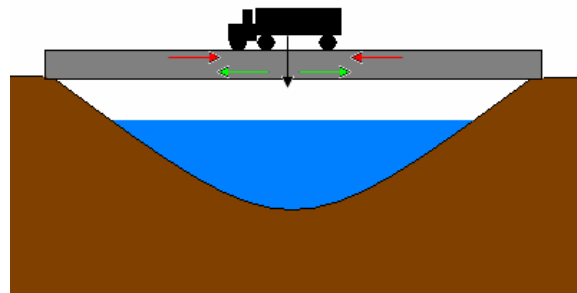
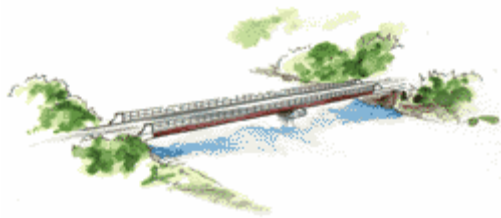

### Arch

Arch bridges rely on the natural strength of the arch shape to distribute the load of a bridge. Arches are generally located across spans with deep bottoms, because the load can be transferred to the sides of the gap. Arch bridges are made from materials that are strong in compression because the entire arch experiences compression even when no load is on the bridge.

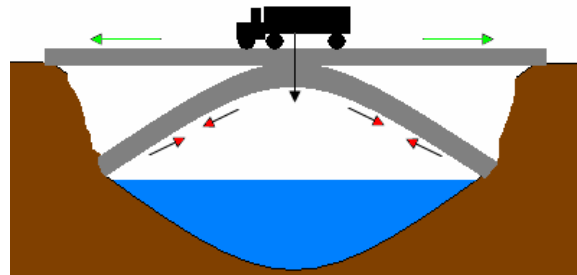

## BRIDGE TYPES (CONT.)

### Truss

The truss bridge draws upon the strength of triangles. It uses many small sections which individually experience only small loads. At any point in the bridge, about half of the material is experiencing a compressive force, and half is experiencing tension. While this is also true for the girder bridge, here each force is experienced by a separate section, rather than the same piece of material. As a result, the intense bending force seen in the girder bridge is not present in the truss bridge. The truss bridge is also rather efficient to build.

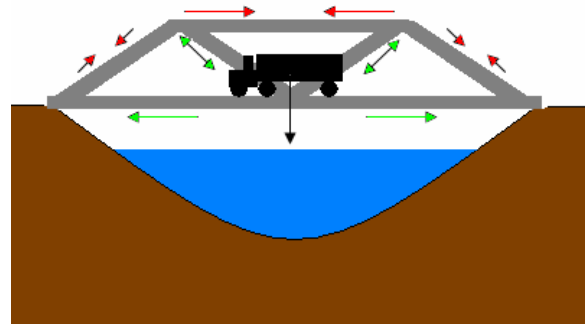

### Cable-Stayed

The cable-stayed bridge introduces cables as a support structure. Cables are different from other materials used in bridge construction because they can only experience tension (not compression or shear). The main difference between this type of bridge and the previous three is that the majority of the load is placed on the vertical supports. The cables, and especially the vertical supports, must be strong enough to handle a significant load.

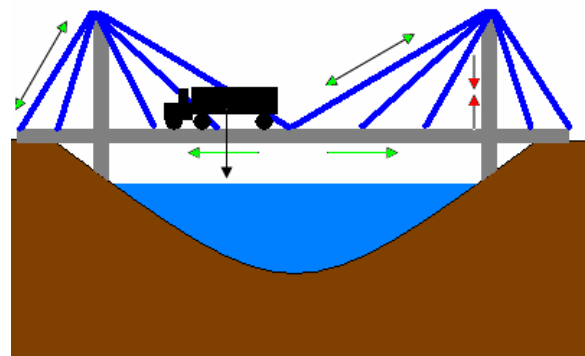



## BRIDGE TYPES (CONT.)

### Suspension

The suspension bridge is very similar to the cable-stayed bridge. The main difference is the addition of a main cable which causes the flat surface of the bridge to be pulled upward, rather than upward and outward. The other cables are attached to the main cable rather than the support columns. This bridge design is most effective for very long spans where a large amount of weight must be supported.

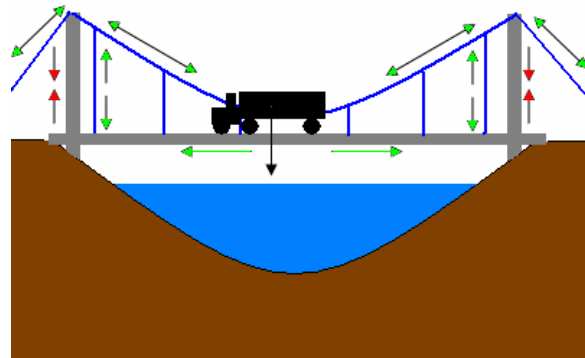

Our bridge type will be \_\_\_\_\_.

Bridge pictures courtesy of <http://www.matsuo-bridge.co.jp/english/bridges/index.shtm>

For information on the stresses on different bridge types, visit

<http://www.pbs.org/wgbh/buildingbig/bridge/basics.html>

## AVAILABLE RESOURCES

Material:	Price per unit (in Kr):
1 hot glue stick & use of hot glue gun	1000
1 bottle of glue	750
1 A4 sheet of heavy paper	200
1 A4 sheet of printer paper	125
1 cm of cellophane tape	2
1 cm of masking tape	4
1 cm of duct tape	6
1 cm <sup>2</sup> of foam core board	10
1 popsicle stick	20
1 straw	10
1 cm of string	1
1 paper clip	5
Pasta (spaghetti)	1
Pasta (fettucine)	3

## IDEAS AND SKETCHES

On this page make some simple sketches and write down ideas for your bridge design.  
This is part of preliminary planning.

## GROUP MATERIALS LIST

Group Number \_\_\_\_\_

The Group Materials List should contain the quantity and cost of all parts purchased for the construction of the bridge, even if they were not used in the final bridge.

QTY	Item	Cost

Total amount of money spent: \_\_\_\_\_

Amount of weight your bridge supported: \_\_\_\_\_

Ratio of weight to money spent (g/kr): \_\_\_\_\_

## TECHNICAL DRAWING TIPS

- Writing in the information boxes should be in all capital letters
- "View:" Enter the perspective of the drawing here. Common perspectives are front, "back," and "right side." These labels allow the viewer to know what part of the item they are viewing.
- "Scale:" This box tells the viewer of the drawing how big the actual structure is. A scale of 1:2 means that the drawing is half the size of the actual object (for every 1 unit in the drawing, it would actually be 2 units).
- "Sheet:" This box shows the current page number.
- Dimensions: All parts of the drawing should have dimensions. This allows for an accurate interpretation of the drawing.

Example:

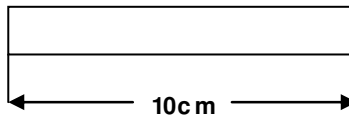

DESIGNED BY:		SHEET:		TITLE:
DATE:	VIEW:	SCALE:		

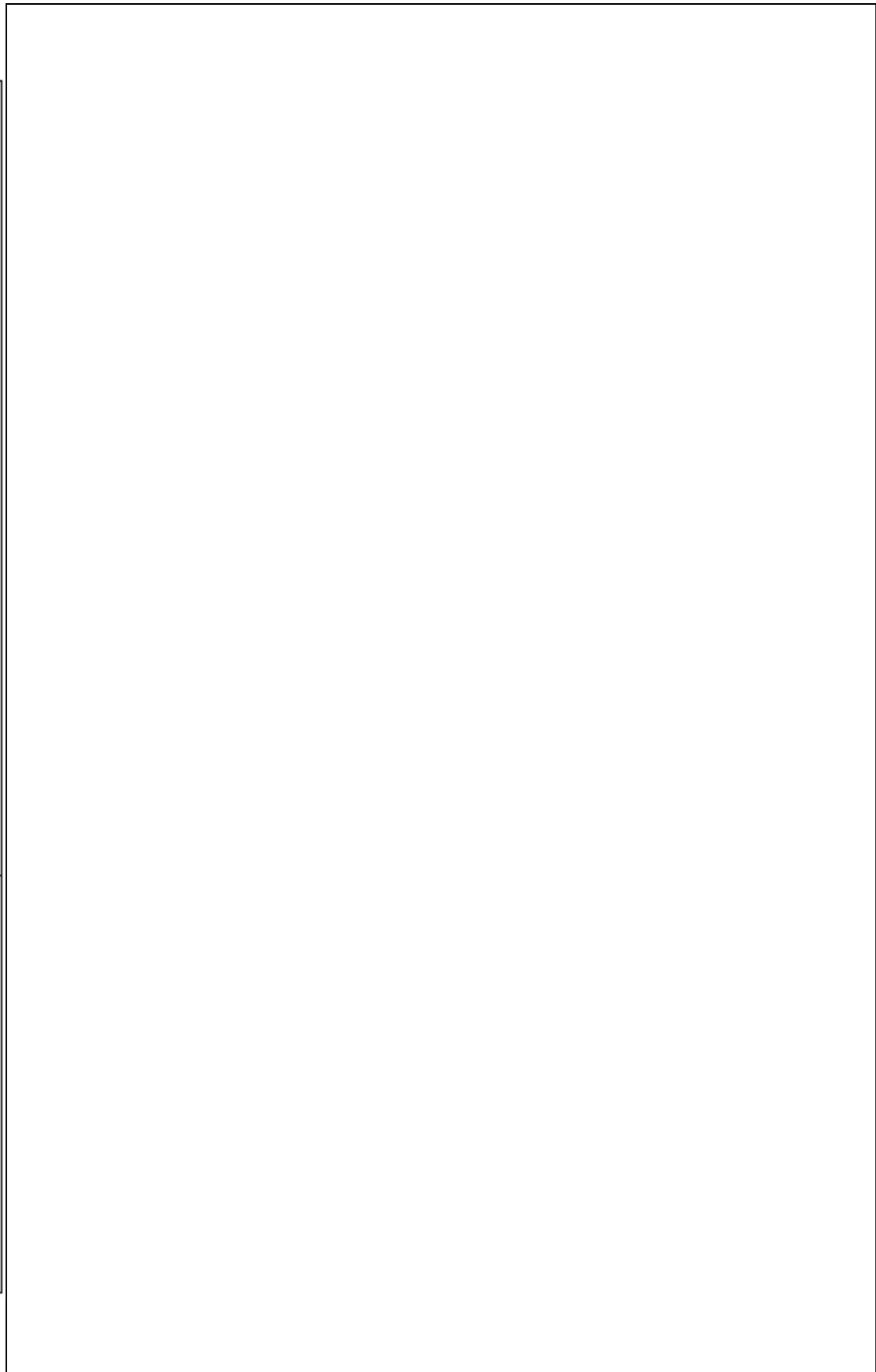

### **6.16. Program Materials: Export Engineering Program**

This appendix contains program materials for the Export Engineering program (*folkeskole* year 8). The first seven pages is the teacher's guide for the program; the following twelve pages are the work pages for the student group booklet.

# Export Engineering

An Experience in Product Design and Business Negotiating

## Folkeskole Year 8

Project



### MATERIALS / COSTS

(all costs given are estimates)



QTY	ITEM	COST
	Program Handouts	-
	Kit Parts	Varies according to class size
TOTAL COST PER PROJECT		Varies by school



6-8x



### TIMING BREADOWN

Preparation Time: ~1 hour

Activity Time: 6-8 hours

### OBJECTIVE

*Students will design products to solve real-world problems, present their ideas to peers, and try to market their product.*

**Fields:** English, creative problem solving, teamwork, understanding economic goals

### Preparation:

1. Print out all necessary handouts.

Per Group;

- 4 Technical Drawing Templates
- 1 Bill of Material Template
- 1 Bid Sheet

2. Obtain all kit parts.

### Procedure:

1. Divide class into four groups.
2. Students decide on a problem they would like to solve.
3. Student groups design a product to solve the problem by trading for supplies with other groups.
4. Students present their solutions to other groups.
5. Students place a value on other products.

### Safety:

- Hot Glue Gun



# Export Engineering

*An Experience in Product Design and Business Negotiating*

## Folkeskole Year 8



### Overview

---

**Game Objective:** End with the most cash and assets and have the most desirable product.

15. Split class into 5 groups or “Countries” (around 4-5 people per group).
16. Students come up with a name for their country.
17. Students brainstorm about problems that affect their daily life that they could solve by creating an invention.
18. Distribute country handouts.
19. Explain that students have a certain amount of material to themselves, and they can trade for other materials with other countries.
20. Have students elaborate on their previous brainstorm. What could they make to solve their problem out of the supplies provided?
21. Students create a technical drawing of their design (labeling parts and materials used, and approximate dimensions), then create a Bill of Materials.
22. Distribute materials according to the country handouts. Students can then trade any time they wish.
23. Students can work on their invention whenever they want.  
**Note:** The time available for trading and construction depends on the total amount of time available. Give time limits to students before beginning so they can work on time management. The introduction should take about  $\frac{1}{4}$  of the total time; trade and construction should be about  $\frac{1}{2}$  of the total time, and the Business and Debriefing should be the remaining  $\frac{1}{4}$  of the total time.
24. After Trade and Construction students add up their total revenue. The country with the most in total assets wins the Trade portion of the game.
25. After assembling their product, students create their sales presentation and present to the rest of the class. Groups evaluate other group products and assign values.
26. After presentations use the bid sheets to find the Design Challenge winner.
27. Debriefing about export engineering.

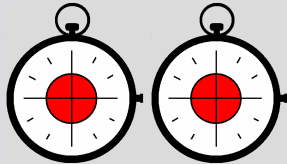

### Preparation

---

Considering each class size is different, preparation for the kit of parts and the student manual varies:

- You can be creative with the kit of parts. It can contain anything that would allow for the students to construct a tangible product. If there is more variety in the kit of parts, students can be more creative.

**Suggested materials:**

- hot glue gun, regular glue
- duct tape, masking tape, cellophane tape
- staples/stapler
- foam core board, cardboard, heavy paper, construction paper, printing paper
- popsicle sticks
- crayons, markers, pens
- string, twine, rope
- straws
- balloons (if there are no latex allergies)
- paper clips
- plastic bags
- soda bottles, coffee cans
- wood, nails, screws
- fabric

etc. Feel free to use items from around the house. The cost of the program is entirely based on the kit of parts. Thus, it can be as elaborate or simple as you want it to be.

- The student manuals need to be adjusted according to the number of students in the classroom and the provided materials.
  - No more than 5 students should be in a group. Adjust the number of groups accordingly.
  - Students decide on a country name and will enter it in the manual.
  - Depending on the provided materials the “Available Resources” page needs to be adjusted accordingly.
    - Each country should have at least 1 unique resource that no other country has.
    - Some resources should be available to multiple groups.
    - List all available resources.
    - List the “average market prices” for each item. These can be the actual cost in a store, or imaginary prices.



2-4 x

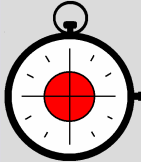

### Student Construction

---

Depending on the available time, give students 2-4 hours to construct their products and trade for supplies. Make sure they are keeping track of the amount they are spending on supplies and resources.

If the project time must be split into multiple days, this section is a good stopping point; simply have students pack their supplies and product together for storage.

Have the students use the Technical Drawing Template to design their product, and the Bill of Materials Template for their materials list.

#### Technical Drawing Tips:

- Writing in the information boxes should be in all capital letters
- "View:" Enter the perspective of the drawing here. Common perspectives are "front", "back" and "right side". These labels allow the viewer to know what part of the item they are viewing.
- "Scale:" This box tells the viewer of the drawing how big the actual structure is. A scale of 1:2 means that the drawing is half the size of the actual object (for every 1 unit in the drawing, it would actually be 2 units).
- "Sheet:" This box shows the current page number.
- Dimensions: All parts of the drawing should have dimensions. This allows for an accurate interpretation of the drawing.

**Example:**

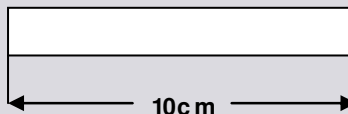

# Export Engineering

*An Experience in Product Design and Business Negotiating*

## Folkeskole Year 8



### Trading

---

**Trading Objective:** Be the country that ends with the highest total assets.

\*\*\*Since this represents international trade, all transactions should be in English\*\*\*

1. Give every country a specific amount of money to be used during trade.
2. Every country has certain materials specific to their country, and a few materials that other countries will have as well.
3. Students can choose whether or not to share the information on their country handouts, including which materials they have and how much of each they have. Suggest that a price list to sell unwanted items to other countries could be helpful.
4. Students can also create services to offer. This is another way for a country to make money or have more bartering power without having to lose raw materials.
5. Students can either designate a seller and a buyer for their country or they can come up with their own system.
6. Students have a list of all the materials available in the game (since other countries may not show all the materials they have available, it is helpful to have a master list) as well as an average “market price” for each material. Students will also need to come up with their own prices or value of their materials for actual retail sale.  
**Note:** Emphasize that prices/values can change throughout the course of the game, but that it is important to have a sales strategy.
7. The exchange of materials can occur in two ways: the students can either buy supplies with money, or they can barter (where goods and services are exchanged for other goods and services).
8. Trading can begin anytime after materials are distributed.

**Note:** Explain that it is important for the students to practice their negotiation skills as this is an essential part of export engineering.

\* It is also fun to use play money in the trade round. If you would like to do so you can print out Monopoly money at <http://www.hasbro.com/monopoly/default.cfm?page=treasurechest>

# Export Engineering

*An Experience in Product Design and Business Negotiating*

**Folkeskole Year 8**

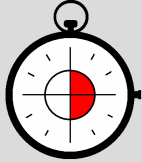

## Business Challenge

---

**Business Objective:** To determine the country with the most marketable product

1. Have each country “sell” their product to the class, highlighting its features and demonstrating how it is used. Each group should take about 5 minutes to present. Have observing students ask questions.
2. Each country will be given 50,000 kr. to spend on products from other groups. After all sales pitches, each group decides how much they would spend on each of the other countries’ product.
3. The countries do not bid on their own product, but they must use up all their money in bidding on each other group’s product.  
**Example:** Country A is given 50,000 kr. They liked Country B’s design the best, so they bid 25,000 kr. on that design. Country C’s design was their second favorite, so they bid 15,000 kr. They really didn’t think Country D’s design was very practical, so they only bid 10,000 kr on their design.
4. Several outside countries can bid on the products as well (such as teachers or mentors).  
**Note:** This is a representation of how the world economy functions. These outside entities each receive 50,000 kr. as well.
5. Have each student group fill out the bid sheet; tally the results on the score sheet.
6. The country that has the highest total of cash bid on their product wins the Design Challenge.

# Export Engineering

*An Experience in Product Design and Business Negotiating*

## Folkeskole Year 8

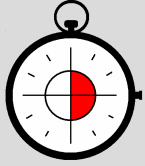

### Debriefing

---

Ask students to reflect on the design process. Did they agree as a team? Was it easy to settle upon a single design?

Then ask students if they thought their peers' evaluation of their product were fair. Were any products considered more valuable than they anticipated? Ask students what factors they considered when deciding the value of a product. (Usefulness, effectiveness, sturdiness, overall quality, etc.)

Export engineering functions much like this program. Export engineers not only must have the technical knowledge of their company's product, but the business and negotiation skills to communicate with other companies, sometimes in foreign languages. This program was designed to introduce students to the field of export engineering, and to show them that the engineering process can be exciting and fun, even for students who don't enjoy math or science classes. Export engineering is a program that is offered at Ingeniørhøjskolen i København in Ballerup.

## AVAILABLE RESOURCES

### **Resources Unique to Country A:**

- Hot Glue Gun

### **Other Resources in Country A:**

- Heavy paper, construction paper, crayons, plastic bags, cardboard, soda cans

### **Resources Available Around the World:**

(These sample prices are not necessarily store costs)

- hot glue gun 100 kr
- regular glue 50 kr
- duct tape 70 kr
- masking tape 50 kr
- cellophane tape 30 kr
- staples/stapler 50 kr
- foam core board 100 kr
- cardboard 20 kr
- heavy paper 30 kr
- construction paper 10 kr
- printing paper 5 kr
- popsicle sticks 5 kr
- crayons 10 kr
- markers 20 kr
- pens 5 kr
- string 50 kr
- twine 50 kr
- rope 75 kr
- straws 10 kr
- paper clips 10 kr
- plastic bags 10 kr
- soda bottles 3 kr
- coffee cans 5 kr
- wood 40 kr
- nails 20 kr
- screws 20 kr
- fabric 100 kr

(The rest of the materials would be on the lists for the other countries. Make sure that Unique Resources do not appear on other country lists. Please use this page as a template for your class.)

# EXPORT ENGINEERING

*An Experience in Product Design and Business Negotiating*



---

(Enter Country Name)

Engineers:



## ENGINEERING PROCESS

Problem Statement: Your country is trying to ease the everyday lives of your citizens. This involves creating a new technology that solves a daily obstacle or problem. Your challenge is to design and build a creation that would solve or ease a problem of your choice.

Design Rules:

1. Brainstorm and determine the problem your country is focusing on.
2. Design the product based off of the provided materials list.
3. Create the technical drawings for the product.
4. Fill out the Bill of Materials in preparation for the Trade Process.
5. Keep the Design Challenge in mind throughout the engineering process.

**Notes and Ideas:**

## DESIGN CHALLENGE

**Design Objective:** Be the country with the most desirable product.

1. Your country has to sell the product to the other countries in the class, highlighting its features and demonstrating how it is used. You will be allowed about 5 minutes for your presentation (use any style, such as a commercial). Answer any questions from the audience.
2. Each country will be given 50,000 kr. You will then, as a country, decide how much you will spend on each of the other countries' products.
3. You do not bid on your own product, but you must use up all your money to determine which product would be in highest demand.  
**Example:** Country A is given 50,000 kr. They liked Country B's design the best, so they bid 25,000 kr. on that design. Country C's design was their second favorite, so the bid 15,000 kr. They really didn't think Country D's design was very practical, so they only bid 10,000 kr on their design.
4. Several outside countries might bid on the products as well (like the teacher).
5. Each country must fill out their bid sheet and an instructor will tally the results on the score sheet.
6. The country that has the highest total of cash bid on their product wins the Design Challenge.

## TECHNICAL DRAWING TIPS

- Writing in the information boxes should be in all capital letters
- "View:" Enter the perspective of the drawing here. Common perspectives are front, "back," and "right side." These labels allow the viewer to know what part of the item they are viewing.
- "Scale:" This box tells the viewer of the drawing how big the actual structure is. A scale of 1:2 means that the drawing is half the size of the actual object (for every 1 unit in the drawing, it would actually be 2 units).
- "Sheet:" This box shows the current page number.
- Dimensions: All parts of the drawing should have dimensions. This allows for an accurate interpretation of the drawing.
- Dimensions: All parts of the drawing should have dimensions. This allows for an accurate interpretation of the drawing.

Example;

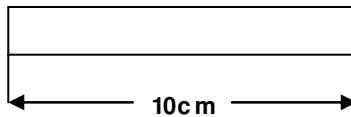

DESIGNED BY:		DATE:		SHEET:	SCALE:	TITLE:
DRAWN BY:		DATE:				

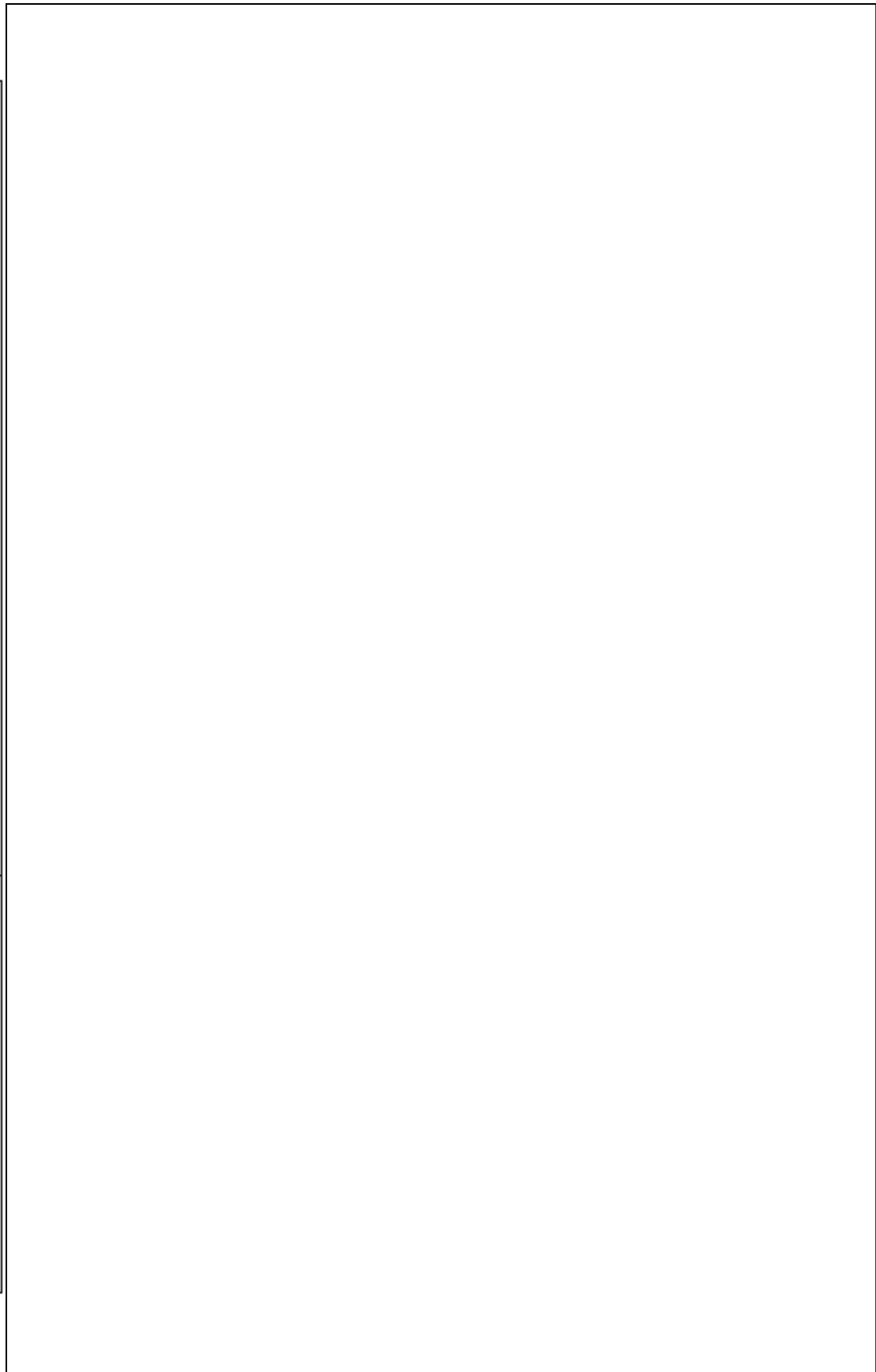



## TRADE PROCESS

**Trade Process Objective:** Be the country that has the highest total assets.

**\*\*\***Since this is international trade, use English for all transactions**\*\*\***

1. Every country is given a specific amount of money to be used during trade.
2. Every country has certain materials specific to their country, and a few materials that other countries will have as well.
3. Your country can choose whether or not to disclose the information on their country's handouts including what materials you have and the quantity of materials.
4. Your country can also create services to offer. This is another way for your country to make money or have more bartering power without trading materials.
5. Either designate a seller and a buyer for your country or come up with your own system.
6. You have been given a list of all the materials available from all countries as well as an average market price for each material. You will also need to decide on your own value of the materials for retail sale.  
**Note:** Prices/values can change throughout the course of the game, but it is important to have a sales strategy.
7. The exchange of materials can occur in two ways: either buy supplies with money, or trade away supplies you don't need.

**Note:** It is important for you to practice negotiating as this is an essential part of export engineering.

## TRADE PROCESS PLAN

(For each topic devise a plan that your country will utilize)

Trading strategy:

Available inventory (resources you will keep):

## TRADE PROCESS PLAN (CONT.)

Price lists (for resources you will sell):

Services available (what services you will offer):



## SALES PITCH

(Create your sales strategy and draft your presentation)

### **6.17. Program Materials: LEGO Mindstorms Program**

This appendix contains program materials for the LEGO Mindstorms program (*gymnasium* year 1). The first six pages is the comprehensive teacher's manual. The next handout is the Game Play Sheet which explains to students the objectives of the game. Following that is the Field Setup Sheet which shows the teacher how to properly set up the game as explained in the Game Play Sheet. Finally, the student Programming Sheet is for students to understand the basics of the LEGO Mindstorms robot programming software, and the teacher Programming Sheet is for the teacher to understand what the final program might look like.

# LEGO Mindstorms

An Engineering Experience with  
Electronics, Mechanics and Physics

## Gymnasium Year 1

Project



### MATERIALS / COSTS

(All costs given are estimates)



QTY	ITEM	COST
Up to 5	LEGO Mindstorms Kit	Free (IHK)
1/group	Computer	--
1	Game Board	Free (IHK)
2	Speakers	Free (IHK)
TOTAL COST PER PROJECT		0



### TIMING BREAKDOWN

Preparation Time: 1.5 hours

Activity Time: 6-10 hours

### OBJECTIVE:

*Students will work in teams to build and program LEGO robots to achieve a goal.*

---

**Fields:** English, computer programming, math, physics

---

### Preparation:

1. Borrow kits (groups of 4-5 students per kit), plus other materials from IHK.
  2. Charge all batteries and make sure kits have all motors and sensors.
- 

### Procedure:

1. Introduce students to programming and LEGO Mindstorms kits.
  2. Introduce students to project goal, break class into groups of 4-5 students.
  3. Groups design, build and test robots.
  4. Groups have their robot perform project goal in front of class.
  5. Discussion and wrap-up.
- 

### Safety:

- Small parts
- 

Lego man image courtesy of [www.pixeljoint.com](http://www.pixeljoint.com)

# LEGO Mindstorms

An Engineering Experience *with Electronics, Mechanics and Physics*

## Gymnasium Year 1

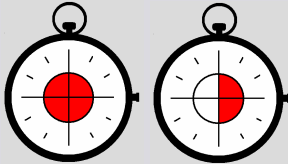

### Preparation

---

1. Obtain the playing field, LEGO Mindstorms kits (one kit for 4-5 students, up to 5 kits) and other supplies from Ingeniørhøjskolen i København by contacting Knud Hansen (khh@ihk.dk).
2. Charge all of the batteries (battery lights will turn green when charged).
3. Install the LEGO Mindstorms software on one computer for each project group. The installation CD is included with Mindstorms. Note that you may need administrator access to install software on school computers.
4. Set up the LEGO field in the classroom according to the Field Setup Sheet.
5. Read through the Student Handout sheet to understand the mechanics of the game, and the Programming Sheet to understand the LEGO software.

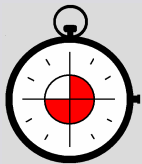

### Introduction

---

#### **Introduction to Project Goal (15 minutes)**

Distribute a Game Play Sheet to each student. Show students the game board. Go through the project goals with the class and make sure each student understands the objectives.

# LEGO Mindstorms

An Engineering Experience *with Electronics, Mechanics and Physics*

## Gymnasium Year 1



### Smørrebrød Programming (Optional, 30 minutes)

Materials: Bread, butter, smørrebrød toppings, knife, plate

1. Divide students into groups of 4-6.
2. Have students make a list of detailed instructions on how to assemble the smørrebrød using only the available materials. Give students about 10 minutes.
3. When groups are finished, take each group's instructions and follow them exactly in front of the class. This should take about 10 minutes.
4. Have students see which steps they missed. Explain how in computer programming, the most detailed steps need to be included to avoid making errors.

### Introduction to LEGO Programming

Distribute a Programming Sheet to each student. Explain that they will be divided into groups. Within a group, half the students will build the robot, and the other half will program it. Note that the LEGO Mindstorms software is entirely in English.

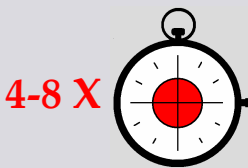

4-8 X

### Student Work

---

### LEGO Mindstorms Kit of Parts (2-4 hours total, can be split up)

1. Divide students into groups of 4-5.
2. Give one LEGO Mindstorms kit to each group.
3. Have students divide into a building team and a programming team.
4. Have the building team build the base robot model as indicated on pages 8-23 of the included instruction manuals. Each student should be able to participate. Each student should become familiar with the parts in the kit and see how the model works.

# LEGO Mindstorms

An Engineering Experience *with Electronics, Mechanics and Physics*

## Gymnasium Year 1



### **LEGO Mindstorms Programming (2-4 hours total, can be split up)**

Have the programming teams set up at one computer each. Allow them to play with the software following the Programming Sheet. Once the building teams have finished the base of the robot, the building and programming teams should work together to figure out how to continue building the robot to play the game using the sensors. Students can use the remaining sections of the manual to add sensors, or be creative with the kit of parts, depending on the amount of time available.

A suggested method for programming the robot involves students mapping out what they intend the robot to do on paper before trying to make it work with the program. This helps them visualize what the robot will be doing.

At the end of any class periods where work will be interrupted, have students save their work (to their user accounts, or a flash drive, or the computer if the same one will be used the next time). Also have students save their work often during the class period.

### **Program Testing (2-4 hours total, can be split up)**

Allow students to test their programs and robots on the playing field to see how their program works. Learning from your mistakes is a key part of the engineering process.

# LEGO Mindstorms

An Engineering Experience *with Electronics, Mechanics and Physics*

## Gymnasium Year 1

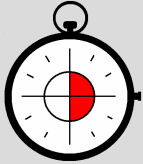

### Game Play

---

Once all teams have finished constructing and programming their robots, follow the instructions under the “Game Play” section of the Field Setup Sheet. Students have successfully achieved the goal if their robot can knock off only the red balls and leave the blue balls and then leave the field.

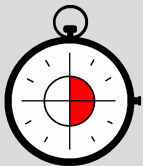

### Debriefing

---

Please have students break down their robots when finished and return the parts to the kits as shown by the cardboard inserts in the kits. Also please return all kit materials to IHK. This will allow future classes to run the program.

Discuss with the students their experience. What parts of the program did they enjoy? Did they have enough time for programming? Was it easier or more difficult than they expected? Did they enjoy the experience?

Mechanical engineers perform the same tasks as the building team did. Figuring out how parts go together to make a whole product is a vital part of the engineering process.

Computer scientists and electrical engineers have to make the same decisions as the programming team. Using computer software to tell a robot what to do is just one example of what many engineers do for a career.

If students enjoyed this experience, they may enjoy a career in engineering.

# LEGO Mindstorms

An Engineering Experience *with Electronics, Mechanics and Physics*

## Gymnasium Year 1



### Advanced Topics

---

When there is extra time available, or for students who have finished programming early in the scheduled time period, this section details some additional tasks they can try.

Students can design the robot such that if the two red balls are knocked over before all four stations are checked, the program is ended.

Students can change their program so that sounds are played if a ball is avoided or knocked down.

Students can also have the robot perform interesting maneuvers (dancing, spinning around, etc.) if they are simply waiting for other groups to finish.



# LEGO Mindstorms Project

## Game Play Sheet

Your company, Big Blue, is planning another mission to the moon to mine resources. Unfortunately your rival company, RocketRed, has already sent up a mission to claim land for themselves. Your goal is to build a robot to destroy their sphere-shaped mineral holds while leaving yours intact.

You know the locations of the four mineral sites, but you do not know which belong to Big Blue and which belong to RocketRed. The sites are arranged in an "X" formation with a black line running in between the four sites.

Since RocketRed is further along in development than Big Blue, you will be able to tell which sites are owned by RocketRed by the sounds coming from the site.

Your robot, once it is built and programmed, should be able to land in the area (you will place it anywhere you like between the mining sites), destroy the two RocketRed mining sites, leave the two Big Blue mining sites alone, and leave the area. You will have a total of 6 hours to build and program your robot. You can refer to the playing field at any time to determine how to go about achieving the goal.

You have at your disposal a kit of materials to build the robot which includes three motors, two touch sensors, a sound sensor, an ultrasonic sensor and a light sensor. Our suggestion is to use the basic robot design as a starting point (found on pages 8-23 of the manual), add the ultrasonic sensor to tell when the robot is at a site (pages 28-31), and add a wrecking arm to destroy RocketRed's sites (pages 50-61). Then add the other sensors as you see fit.

The future of the Big Blue Company depends on the success of this mission. We wish you good luck!

# LEGO Mindstorms Project

## Field Setup Sheet

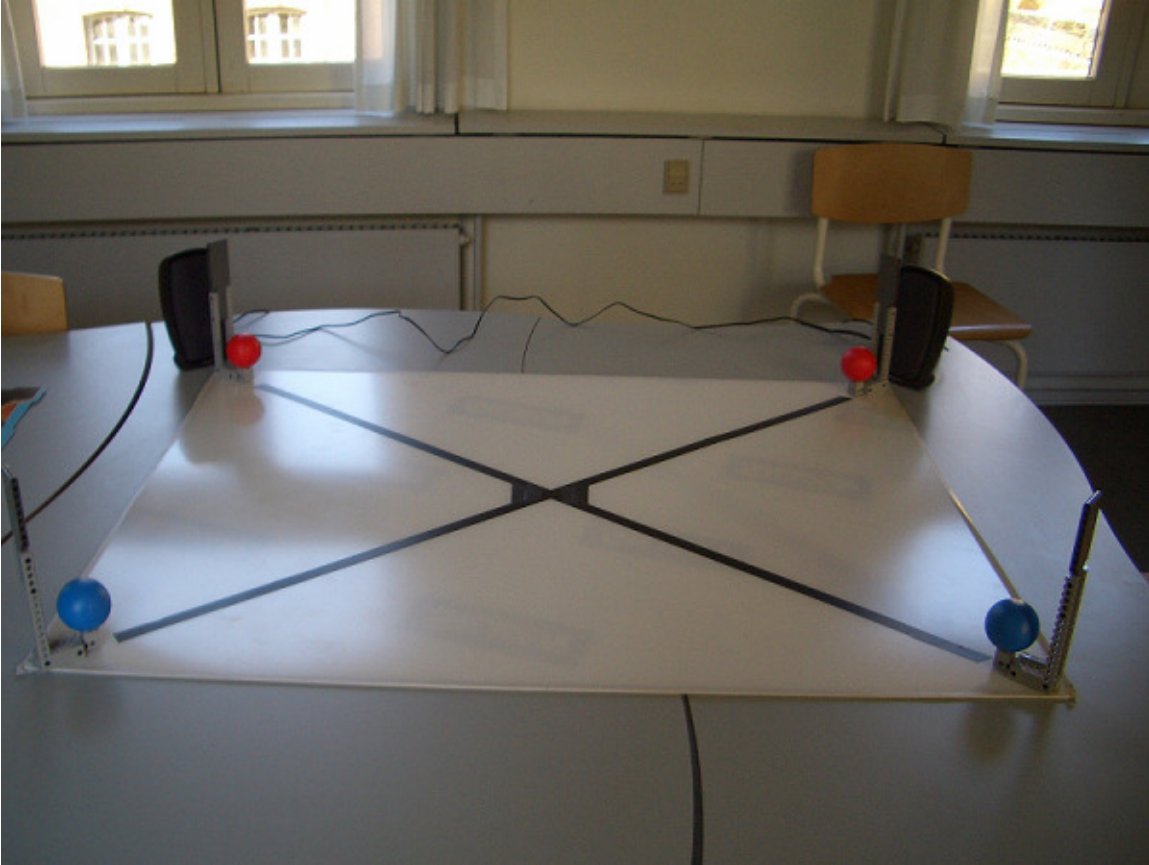

The playing field is mostly pre-assembled, and all necessary parts come from the LEGO Mindstorms kits or are provided along with the kits from IHK.

The field itself consists of an acrylic sheet and four ball holders (which come pre-assembled from the LEGO Mindstorms kits, or can be constructed following pages 62-67 of the manual). Black tape stuck to the playing field connects opposite ball holders.

### **Assembly**

The field should take no more than 5 minutes to assemble and should look like the picture below when finished. Students should know that the location of the balls will be random, but that the speakers will always be behind the red balls.

1. Find an area on the ground large enough for the playing field.



2. Take the LEGO ball holders and place them at the corners, facing the center of the field.
3. Using a CD player or computer, insert the CD provided with the kit and plug in the provided speakers.

### **Game Play**

1. Have a student group place their robot anywhere on the field they wish.
2. Place 2 red balls and 2 blue balls on the ball holders *in random positions*.
3. Place the CD speakers behind the red ball holders aiming at the center of the field. Play the CD.
4. Have the group run their program. After the completion of the program, reset the field and repeat with the remaining groups.
5. Any robot that leaves the blue balls, knocks down the red balls, and leaves the playing field has successfully achieved the goal.

# Guide to LEGO Programming

Your LEGO Mindstorms kits can be programmed using the provided graphical language. This guide will show you the basic symbols that you will need to program your robot. All of these blocks can be found at the left side of your screen and dragged to where you want them. Each block has a set of controls that appear when it is selected.

The program starts at this point  and plays blocks in order along the connecting bars .

**MOVE:** These blocks allow you to control the three servo motors that you can attach to your robot. The controls (found in the bottom left of the screen) allow you to: select which motors to control, the direction that they rotate (or stop them), the balance of power between two motors (steering), the power given to the motors and the amount of rotation you want (in degrees, rotations, seconds or unlimited). It is recommended that motors B and C be used to move the robot and that A be used for actions.

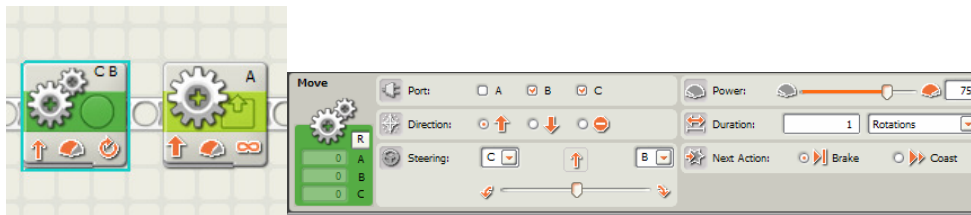

**TOUCH SENSOR:** The touch sensor can be set to respond to being pressed, being released or being pressed and then released. Recommended port: 1



**SOUND SENSOR:** The sound sensor listens and reports sound on a scale of 0-100%. You may set it to respond to any reading less than or greater than a certain percentage. Recommended port: 2



**LIGHT SENSOR:** The light sensor is controlled the same way as the sound sensor (scale of 0-100), but it has the option to also make its own light, to reflect off of objects. Recommended port: 3



**ULTRASONIC SENSOR:** The ultrasonic sensor uses beams of sound to see how far away objects are. It can read from 0 to 255 cm or 0-60 inches can be set to read below or

above a number. (Hint: this sensor works best on solid objects, soft fabric and skin may give bad data)



**LOOPS:** These blocks let you make other blocks play over and over until some condition is met. Below is a loop with a move block in it. It is set to activate the motor until the light sensor reads more than 50%. After that the program will move on to the next action.

Notice that the control is set to “Sensor” this gives the option to use any of the sensors to make the loop end. You may also set it to “Count” to make the loop play a number of times or to “Time” to make the loop play for a number of seconds.

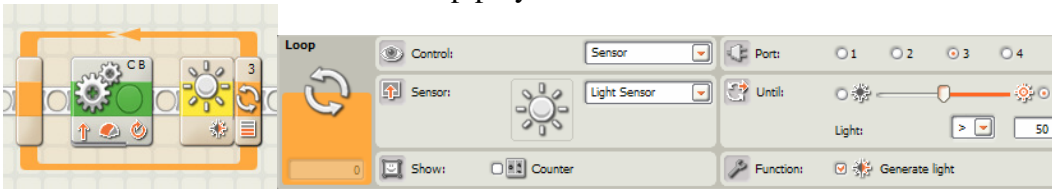

**SWITCHES:** The switch block lets the robot choose between two different sets of actions based on readings from sensors. The controls are the same as the loops with sensors. The upper program will play if the set conditions are met, otherwise the bottom will. The switch does not loop; actions inside will only play once.

The switch below will activate motor A if the touch sensor is pressed, but play a sound if not.

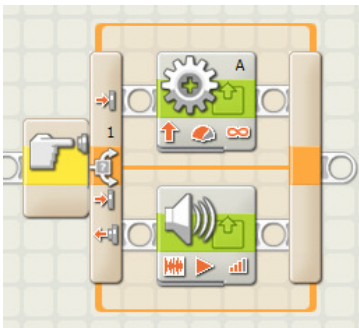

**COMMUNICATION:** These buttons will let you send and receive data from a robot connected with USB or Bluetooth. The bottom left button will put your current program into robot. The center button will put the program on and make it play (recommended for Bluetooth only). The upper left button will open controls to change the connection settings and to control memory use (you may need to delete old programs to make room for new ones!!).



**HINTS:**

You can put loops and switches inside each other.

The symbols on the bottom of the block will change when you change the controls.

(Move blocks display direction, power and durations with the 3 symbols)

A move block set to unlimited rotation that is inside a loop will run until the loop ends, unless something else inside the loop stops it.

**See page 7 of the user guide to see how to test the sensors.**

**Sample:** What does this program do?

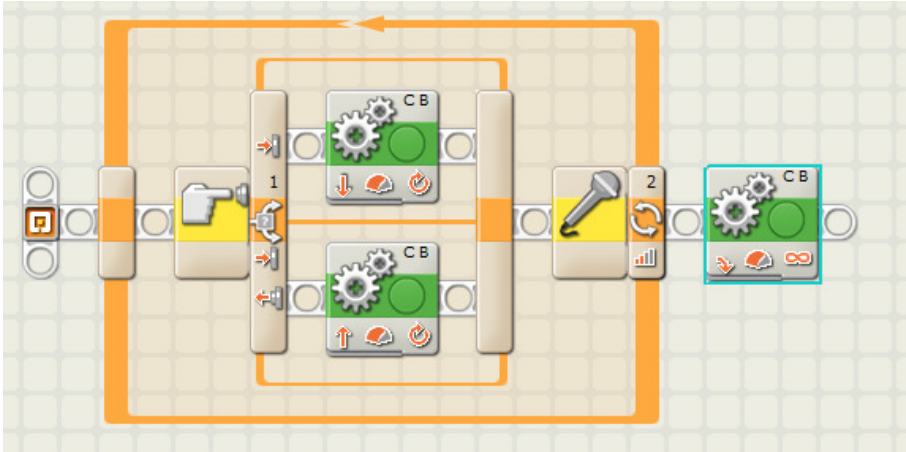

# Instructor LEGO Programming Guide

This guide is meant for teachers only. It will provide additional information to help you guide your students towards a successful program.

The LEGO Mindstorms NXT software has video tutorials that will help you to understand the actions that students will need to program into their robots to complete the goal. Below is a sample program that will complete the task for this project. You will need to adjust the motor powers, rotation distances and sensor settings yourself. We will discuss the different parts of the program.

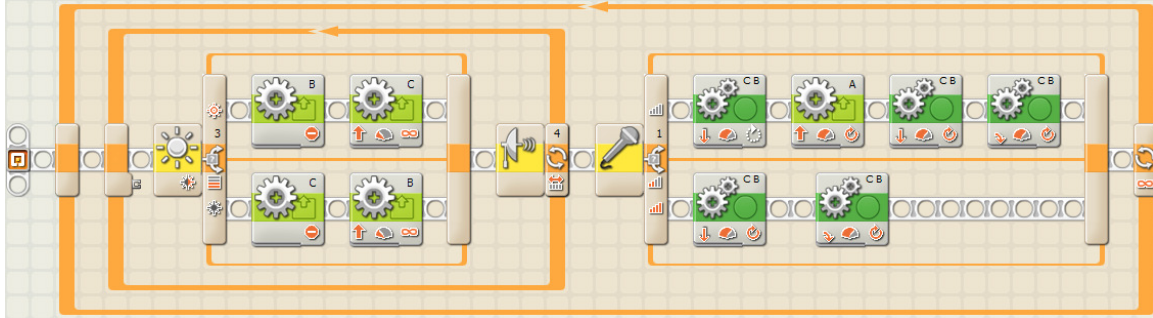

**Line following:** See Common Palette tutorial #17. The program here uses the switch block, controlled by the light sensor to activate the left and right motors in response to the color of the ground. When over a black surface, the robot will turn towards the white surface and will do the opposite when over the white surface. This action is very important to navigating the game board. The black X should help the robot find its way to the targets. Adjusting power levels will control speed and accuracy (with very low power, the robot will follow the line very closely but will do so slowly). If students are having difficulty with the robot following the line when the robot reaches the center then you may add more black tape or paper to ensure that they do not miss; they can also slow down the robot. For the supplied board try setting the light sensor to 45%.

**Distance Control:** As you can see, the line-following switch is inside a loop controlled by the ultrasonic sensor. This means that the robot will follow the black line until it gets a certain distance away from the stands holding the balls. Try setting it for <26 cm. The goal is to get the robot close enough for the arm to hit the ball but not so close that it hits every ball as part of moving.

**Decision making:** After the first loop we have a sound activated switch. Because there will be speakers making noise next the balls that the robots must knock down and no speakers next the other two balls, one can use the sound sensor to choose between spinning the arm and moving away. The settings for the sound sensor will depend on the volume of the speakers. Use the view option (pg 7 of the user guide) to measure sound next to a speaker and at other locations on the board.

In the top path (sound louder than value) we first see a move block set to move backwards. It will only cause 1 degree of rotation, to stop forward motion. Next is a move block for port A. This causes the arm to spin, thus striking the ball. ¼ rotations of motor A will cause 1 full rotation of the arm. Next is a reverse block for B and C. Followed by a turn block for B and C. These cause the robot to move back and turn

around. The exact distance turned is best found through testing, but make sure that the robot is on the opposite side of the black line for it to continue following the path.

The bottom path simply pulls the robot back (to avoid hitting the ball accidentally) and turns it around.

**END OF LOOP:** After the sound switch plays, the entire sequence starts from the beginning. The robot will follow the line to the next target. This loop is set to continue forever, but could also be set to play only 4 times.

**COMMENTS:** This is only one solution to the problem, and **WE RECOMMEND AGAINST SHOWING THIS PROGRAM TO YOUR STUDENTS.** Let them try to create their own program and solve the problem themselves as much as possible.



**6.18. *Program Materials: Experience Engineering Program***

The teacher guide for the Experience Engineering program is reproduced below. The guide is relatively short as there is not much work to be done on the part of the teacher running the class, short of arranging for the appropriate speakers ahead of time.

# Experience Engineering Program

*A student introduction to the life of an engineer*

## Gymnasium Year 2

**Project**



### MATERIALS / COSTS

(all costs given are estimates)



ITEM	COST
Transportation to IHK	Varies

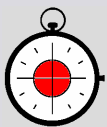

6x



### TIMING BREAKDOWN

**Preparation Time: 1 hour**

**Activity Time: 6 hours**

### **OBJECTIVE:**

*Students will be able to experience the life of an engineer both during secondary education and as a career.*

**Fields:** Math, science, engineering

### **Preparation:**

1. Contact IHK for college program.
2. Contact engineers for career program.

### **Procedure:**

1. Students visit IHK for a few hours to use equipment for a laboratory prepared and run by IHK students.
2. An engineer visits the folkeskole to discuss his/her experience as an engineer.

# Experience Engineering Program

*A student introduction to the life of an engineer*

## Gymnasium Year 2



### College Program

---

Contact IHK students through Knud Hansen (khh@ihk.dk) about the college program. A student will prepare a demonstration on-site at IHK for the students to be able to experience a college-level laboratory.

### Career Program

---

For previous programs, both Vestas and Mærsk were contacted through their websites. The contact at Mærsk was Lars Novrup (LNO@maerskoil.com), who was able to arrange for a Well Site Engineer to speak with students. Many other engineering companies are willing to send representatives to schools to talk about their company. Simply ask the companies well in advance with a particular date in mind and they will most likely be able to find an engineer to speak with students.

Possible discussion points are listed below. Feel free to modify this list to your convenience.

- Schools the engineer attended
- Anything in particular they enjoyed about the education
- Reasons for choosing engineering
- Description of the company they work for
- Everyday job description
- Use of math and science on the job
- Job tasks not requiring math and science
- Social importance of engineering

### 6.19. Quantitative Survey Results

#### Summary including both schools

Statement	G Pre Average (n=26)	G Post Average (n=18)	G Test Change	F Pre Average (n=43)	F Post Average (n=33)	F Test Change
1	2.08	2.44	0.37	3.12	3.55	0.43
2	1.92	2.44	0.52	2.86	3.64	0.78
3	2.62	2.44	-0.17	4.00	3.97	-0.03
4	2.42	2.78	0.35	3.63	3.91	0.28
5	3.15	3.89	0.74	3.33	3.91	0.58
6	1.69	2.56	0.86	2.45	3.00	0.55
7	2.04	2.94	0.91	2.88	3.56	0.68
8	1.62	2.06	0.44	2.38	2.74	0.36
9	2.62	3.17	0.55	3.49	3.66	0.17
10	1.73	2.50	0.77	2.98	3.32	0.35
11	2.84	2.83	-0.01	3.07	3.13	0.05
12	3.42	3.33	-0.09	3.80	3.48	-0.32
13	2.41	2.67	0.26	2.60	2.72	0.12
14	2.62	2.72	0.11	2.83	3.09	0.26
15	4.35	4.33	-0.01	4.07	4.33	0.26
16	4.42	4.33	-0.09	4.38	4.61	0.23
17	3.93	3.89	-0.04	4.23	4.21	-0.02
18	3.46	3.28	-0.18	3.79	3.91	0.12
19	1.73	2.06	0.32	3.70	3.79	0.09
20	1.77	2.11	0.34	3.37	3.36	-0.01
21	1.92	2.22	0.30	3.21	3.56	0.35

“Statement” refers to the statements as numbered in Appendix 3. G refers to *gymnasium* class, F refers to *folkeskole* class. “Pre average” is the averaged survey response before the program; “post average” is the averaged survey response after the program. Test change is the difference between the post and pre average. Responses averaging lower than “disagree” are highlighted in pink; responses averaging higher than “agree” are highlighted in blue; test changes that showed an increase of 0.5 survey points or more are highlighted in green.

### Gymnasium-only comprehensive results

Gymnasium Pre-program						Gymnasium Post-program						Test Change	
Statement	1	2	3	4	5	Avg	1	2	3	4	5	Avg	
1	9	9	5	3	0	2.08	2	7	8	1	0	2.44	0.37
2	9	10	7	0	0	1.92	3	6	8	0	1	2.44	0.52
3	2	7	16	1	0	2.62	2	8	6	2	0	2.44	-0.17
4	2	11	13	0	0	2.42	3	2	10	2	1	2.78	0.35
5	5	3	4	11	3	3.15	0	0	4	12	2	3.89	0.74
6	13	8	5	0	0	1.69	4	2	10	2	0	2.56	0.86
7	9	7	10	0	0	2.04	0	4	11	3	0	2.94	0.91
8	15	8	2	0	1	1.62	6	4	7	0	0	2.06	0.44
9	6	4	11	4	1	2.62	0	3	9	6	0	3.17	0.55
10	11	11	4	0	0	1.73	3	6	6	3	0	2.50	0.77
11	0	5	19	1	0	2.84	1	2	14	1	0	2.83	-0.01
12	0	1	13	12	0	3.42	0	1	11	5	1	3.33	-0.09
13	4	10	11	2	0	2.41	3	4	8	2	1	2.67	0.26
14	3	9	11	1	2	2.62	3	4	7	3	1	2.72	0.11
15	0	0	6	5	15	4.35	1	0	3	2	12	4.33	-0.01
16	0	0	4	7	15	4.42	1	0	3	2	12	4.33	-0.09
17	0	1	4	18	4	3.93	1	1	1	11	4	3.89	-0.04
18	0	1	13	11	1	3.46	0	2	10	5	1	3.28	-0.18
19	13	8	4	1	0	1.73	5	8	4	1	0	2.06	0.32
20	12	10	2	2	0	1.77	7	5	4	1	1	2.11	0.34
21	9	10	7	0	0	1.92	3	8	7	0	0	2.22	0.30

This chart shows the number of responses at each response level for each question, both before and after program implementation, for the *gymnasium* LEGO Mindstorms program. Response levels are highlighted in yellow, averaged responses lower than “disagree” are shown in pink, and averaged responses higher than “agree” are shown in blue. Increases in averaged responses over the testing period above 0.5 are highlighted in green. Although this cutoff point does not represent that the results are statistically significant, they are still suggestive. Changes in averaged responses less than 0.5 were assumed to be statistically insignificant.

The same color scheme is applied for the *folkeskole* windmill program implementation results on the following page.

**Folkeskole-only comprehensive results**

Folkeskole Pre-program							Folkeskole Post-program							Test Change
Statement	1	2	3	4	5	Avg	1	2	3	4	5	Avg		
1	2	15	10	8	8	3.12	2	4	9	10	8	3.55	0.43	
2	6	11	12	11	3	2.86	0	7	5	14	7	3.64	0.78	
3	0	1	9	22	11	4.00	0	1	7	17	8	3.97	-0.03	
4	2	3	15	12	11	3.63	0	2	9	12	10	3.91	0.28	
5	2	6	14	18	3	3.33	1	0	9	14	9	3.91	0.58	
6	9	11	18	2	2	2.45	3	5	17	5	3	3.00	0.55	
7	3	10	20	7	2	2.88	0	5	8	15	4	3.56	0.68	
8	9	15	13	3	2	2.38	5	9	8	7	2	2.74	0.36	
9	0	4	17	16	4	3.49	1	3	8	14	6	3.66	0.17	
10	2	12	16	9	3	2.98	1	5	11	11	3	3.32	0.35	
11	3	5	20	12	1	3.07	1	4	19	6	2	3.13	0.05	
12	0	0	14	21	6	3.80	0	0	19	9	3	3.48	-0.32	
13	2	16	21	3	0	2.60	3	6	21	1	1	2.72	0.12	
14	2	11	23	4	2	2.83	3	5	13	8	3	3.09	0.26	
15	2	2	6	13	19	4.07	1	1	3	9	19	4.33	0.26	
16	1	2	3	10	26	4.38	0	0	3	7	23	4.61	0.23	
17	1	2	0	23	17	4.23	0	1	3	17	12	4.21	-0.02	
18	0	2	14	18	9	3.79	0	1	7	19	6	3.91	0.12	
19	1	6	11	12	13	3.70	2	2	6	14	9	3.79	0.09	
20	1	8	18	6	10	3.37	3	5	9	9	7	3.36	-0.01	
21	1	6	21	11	3	3.21	2	3	9	11	7	3.56	0.35	

**6.20. *Program Implementation Photographs***



Dan helping gymnasium students with programming during the LEGO implementation.



Gymnasium students building robots during the LEGO implementation.

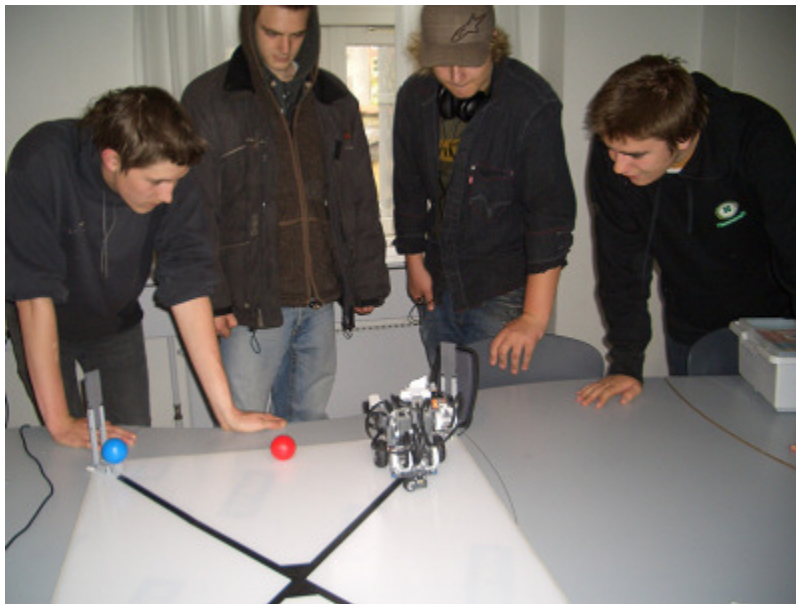

One LEGO program group testing the robot for programming flaws.



Another group during LEGO robot testing.





Dan teaching *folkeskole* students about induction during the windmill implementation.



One group with their completed windmill.



Two groups displaying their turbines turning in the wind.



One volunteer IHK student explaining the windmill to younger interested students at the *folkeskole*.

## 7. Bibliography

- [1] European Commission. Eurydice. National Summary Sheets on Education Systems in Europe and Ongoing Reforms - Denmark. Sept. 2006. 27 Jan. 2007. <<http://194.78.211.243/Eurybase/Application/frameset.asp?country=DK&language=EN>>
- [2] "Facts and Figures 2005 – 4 Pupil/Student Flows." Danish Ministry of Education. 27 Jan. 2007 < <http://pub.uvm.dk/2005/facts/kap04.html>>.
- [3] Donovan, S., Hecht, A., & Woodard, J. (2005) *Developing a Robotics Outreach Program*. Unpublished Interactive Qualifying Project. Worcester Polytechnic Institute.
- [4] Bradley, S. C., Paonessa, M. E., & Tenczar, J. M. (2000) *Design of a Robotics Workshop for Camp REACH*. Unpublished Interactive Qualifying Project. Worcester Polytechnic Institute.
- [5] Mooney, Michael A., and Timothy A. Laubach. "Adventure Engineering: a Design Centered, Inquiry Based Approach to Middle Grade Science and Mathematics Education." Journal for Engineering Education 91 (2002): 309-318. 21 Jan. 2007 <<http://www.adventureengineering.org/references/paper.1.pdf>>.
- [6] Miller, Marilyn. "Engineering Outreach Programs for K-12." 10 Oct. 2006. Young Scientists of America of the University of Wisconsin. 21 Jan. 2007 <<http://ysa.engr.wisc.edu>>.
- [7] Jeffers, Andrew T., Angela G. Safferman, and Steven I. Safferman. "Understanding K-12 Engineering Outreach Programs." Journal of Professional Issues in Engineering Education and Practice (2004): 95-108. 24 Jan. 2007.
- [8] Benenson, G., J. L. Neujahr, H. Seignoret, and E. Goldman. "Encouraging Engineering Students to Become." American Society for Engineering Education (1997). 28 Jan. 2007.
- [9] Poole, S. J., J. L. Degrazia, and J. F. Sullivan. "Assessing K-12 Pre-Engineering Outreach Programs." American Society for Engineering Education (1999). 26 Jan. 2007.
- [10] Price, A. H. "Recommendations for Establishing Small Scale K, 1 Outreach." American Society for Engineering Education (2000). 26 Jan. 2007.
- [11] Cyr, M., V. Miragila, T. Nocera, and C. Rogers. "A Low-Cost, Innovative Methodology for Teaching Engineering Through Experimentation." Journal of Engineering Education (1997). 26 Jan. 2007.

- [12] "Intellect Quest." Massachusetts Academy of Math and Science At WPI. 19 Dec. 2006. 11 Feb. 2007 <<http://www.massacademy.org/Camps/intellectquest.html>>.
- [13] Bang, Henrik. Personal interview. 8 Feb. 2007. (See Appendix 5)
- [14] Hansen, Knud H. E-Mail interview. Jan.-Mar. 2007. (See Appendix 7)
- [15] Herguth, Yvonne. Personal interview. 21 Mar. 2007. (See Appendix 8)
- [16] Biernaki, J. J., L Walhof, and Y. Shao. "Infrastructure Materials: an Inquiry-Based Design Sequence." American Society for Engineering Education (1997). 26 Jan. 2007.
- [17] Tsang, E, and E. J. Newman. "Service-Learning's Effect on Engineering Students and K-12 Teacher Partnership in a "Mechanical Engineering" Course." Institute of Electrical and Electronics Engineers (1998). 25 Jan. 2007.
- [18] Spencer, P. (2005) *LEGO Robotics in Elementary Education*. Unpublished Interactive Qualifying Project. Worcester Polytechnic Institute.
- [19] Cyr, Martha. Personal interview. 31 Jan. 2007. (See Appendix 4)
- [20] Genalo, Lawrence, Melinda Gallagher, and Jenny Golder. "An Engineering Linkage to K-12 Teachers." Proceedings, ASEE Conference (2001). 21 Jan. 2007 <[http://www.asee.org/conferences/search/00328\\_2001.PDF](http://www.asee.org/conferences/search/00328_2001.PDF)>.
- [21] "Upper Secondary Education." Danish Ministry of Education. 27 Jan. 2007 <<http://eng.uvm.dk/education/Upper/Upper.htm?menuid=1520>>.
- [22] "The Danish Higher education system." Danish Ministry of Education. 27 Jan. 2007 <<http://eng.uvm.dk/factsheets/dvu.htm?menuid=2520>>.
- [23] IHK Students. Personal interview. Mar. 2007. (See Appendix 9)
- [24] "Danish Initiatives within Science and Technology Education." Danish Ministry of Education. 27 Jan. 2007 <<http://eng.uvm.dk/factsheets/initiatives.pdf>>.
- [25] "OECD PISA." Social Forsknings Instituttet. 13 July 2005. 28 Jan. 2007 <<http://www.sfi.dk/sw198.asp>>.
- [26] "Danish Initiatives within Science and Technology Education." Danish Ministry of Education. 27 Jan. 2007 <<http://eng.uvm.dk/factsheets/initiatives.pdf>>.
- [27] "Engineering and the Public." International Council of Academies of Engineering and Technological Sciences Inc. 08 Jan. 2007

- <<http://www.nae.edu/NAE/NAECAETS/nsf/weblinks/NAEW-5CAJJV?OpenDocument>>.
- [28] "Better Education – Chapter 2 – Educational policy action areas." Danish Ministry of Education. 27 Jan. 2007 <<http://pub.uvm.dk/2002/better1/02.htm>>.
- [29] Lidegaard, Martin. Personal interview. 14 Mar. 2007. (See Appendix 12)
- [30] Crawford, R. H., K. L. Wood, L. M. Fowler, and L. J. Norrell. "An Engineering Design Curriculum for the Elementary Grades." Journal of Engineering Education (1994). 26 Jan. 2007.
- [31] Erwin, B. "K-12 Education and Systems Engineering: a New Perspective." American Society for Engineering Education (1998). 28 Jan. 2007.
- [32] Ondracek, R. P., and D Leslie-Peckey. "Science Works: a University-Based Science Outreach Group." American Society for Engineering Education (1999). 28 Jan. 2007.
- [33] Mattox, Douglas M., and Bahador Ghahramani. "Learning-Style, Oriented Web-Based Support Modules." American Society for Engineering Education (2000). 28 Jan. 2007.
- [34] Pritchard, M. S., and E. Tsang. "Service Learning: a Positive Approach to Teaching Engineering Ethics and Social Impact of Technology." American Society for Engineering Education (2000). 26 Jan. 2007.
- [35] Felder, Richard M., Donald R. Woods, James E. Stice, and Armando Rugarcia. The Future of Engineering Education; Teaching Methods That Work. 15 Feb. 2007.
- [36] B.S. Bloom and D.R. Krathwohl, *Taxonomy of Educational Objectives. Handbook 1: Cognitive Domain*. Addison-Wesley, New York, 1984
- [37] Velk, Per & Toennersen, John. Personal interview. 26 Mar. 2007. (See Appendix 10)
- [38] Thomsen, Thom. Personal interview. 25 Jan. 2007. (See Appendix 6)
- [39] "About Us - Corporate Information - Vision." LEGO. 2007. 11 Feb. 2007 <<http://www.lego.com/eng/info/default.asp?page=vision>>.
- [40] "Factsheet: the Folkeskole." Danish Ministry of Education. 22 Dec. 2006. 10 Apr. 2007. <<http://eng.uvm.dk/publications/factsheets/fact2.htm?menuid=1515>>
- [41] "R&D At the Exploratorium." The Exploratorium. 21 Jan. 2007 <<http://www.exploratorium.edu/partner/research.html>>