

# Designing a Mobile Chicken Coop

An Interdisciplinary Qualifying Project

Submitted to the faculty of

**Worcester Polytechnic Institute**

In partial fulfillment of the

Requirements for the Degree of Bachelor of Science

*Respectfully Submitted By:*

---

Keegan Cole – BME 2015

---

Lindsey DeLuca – Aero 2015

---

Kimberly Zielinski – ME 2015

## **Advisors:**

---

Professor Robert Hersh

---

Professor Suzanne LePage

**March 5, 2014**

## Designing a Mobile Chicken Coop

### **Abstract**

To both farmers and the general public, organic chicken farming is a means to promote sustainability and positively impact the environment. We collaborated with NOFA to identify improvements in organic chicken farming by developing mobile chicken coops for organic farmers. Mobile chicken coops benefit the well-being of chickens by providing protection and healthy living spaces, and they can lead to more productive pastures as chickens fertilize the fields and eat grubs and parasites as part of their daily routine.

### Acknowledgements

Thanks to our faculty advisor Professor Hersh for keeping our project on track throughout the academic year. His advice, suggestions and overall concern with our efforts helped to spark motivation within our group, which willed this project to completion. We thank him for his patience and ability to read and comment on numerous drafts with much patience and useful constructive criticism. This project would not have been such a positive experience if not for Professor Hersh.

Thanks to our second advisor Professor LePage for providing thoughtful and helpful insight throughout the duration of this project. Her genuine interest in guiding us to create a successful project served as keen motivation. Her ideas and input greatly influenced the success of our project and for that we owe her many thanks.

Thanks to our two project sponsors Jack Kittredge and Julie Rawson for their participation in this project. Their willingness to invite us into their home for interviews in order to provide design feedback and professional knowledge concerning organic farming was much appreciated.

Thanks to all those we contacted over the duration of this project and responded with kindness and advice. A special thanks to Pam Raymond and her family for taking interest in our project and providing helpful information concerning mobile chicken coops. Also thanks to Jassy Bracko and her family for inviting us into their home and offering constructive feedback and ideas. Thanks to Laura Hanlan for showing us how to correctly utilize Gordon Library's resources.

## Executive Summary

This report concerns the development and improvement of mobile chicken coop designs for organic farmers in collaboration with the Northeast Organic Farming Association. These designs address five major parameters that need to be considered when building a mobile chicken coop: portability, protection, cost, feasibility, and the use of non-toxic materials. Each of these parameters was investigated independent from one another but were all considered in each of the final designs produced from this project.

Organic farmers, both large scale and small scale, are looking for a means to raise chickens in an environment where they can be protected from predators and bad weather while



Figure 2: Mobile Chicken Coop

Image courtesy of Pam Raymond.

also providing for their needs. From people who are looking to eat healthier or those who want to raise chickens in their backyard, there has been a significant increase in organic chicken farming. Because of this change, organic producers could benefit from using a mobile chicken as a way to protect their chickens from harm. The underlying issue of raising chickens is protecting them from outside predators such as raccoons, foxes, coyotes, and hawks. Chickens also need to be safeguarded against inclement weather, such as rainstorms or extreme heat. These dangers kill a countless number of chickens which in turn impacts farmers' time and money. Besides producing revenues for farmers from eggs and meat sales, chickens can spread their own manure across the pasture to fertilize soil. Moreover, free range chickens eat grubs and bugs that might be harmful to the produce planted by the farmer or to grass fed cattle. For individuals who don't have time to

also providing for their needs. From people who are looking to eat healthier or those who want to raise chickens in their backyard, there has been a significant increase in organic chicken farming. Because of this change, organic producers could benefit from using a mobile chicken as a way to protect their chickens from harm. The underlying issue of raising chickens is protecting them from outside predators such as raccoons, foxes, coyotes, and hawks. Chickens also need to be safeguarded



Figure 1: Salatin Coop

Image courtesy of Pam Raymond.

## Designing a Mobile Chicken Coop

supervise their chickens constantly, there needs to be a way to keep them safe while allowing them to live in a valuable setting.

This problem can be addressed by using a mobile chicken coop, which can offer protection while providing mobility to allow the chickens to feed on new ground daily. Our project sought to design a mobile chicken coop that can be used both for large scale and small



Figure 3: Threat of predation

<http://www.artofmanliness.com/2013/03/26/how-to-raise-backyard-chickens/>

scale enterprises. We aimed to improve upon past designs and incorporate the design ideas we identified through research and in our interviews with practitioners. We decided to develop 3 alternative designs that can fit a wide variety of needs based on the goals of the farmer. In order to come up with these designs, we first needed to find out what criteria were most important when it comes to building a mobile

chicken coop. Through interviews and talks with farmers, we found that protection from predation and portability was crucial.

For farmers, wildlife can pose a huge threat to the survival of the chickens. One of the first items that need to be added for protection is a steel mesh. Generally, farmers use chicken wire as a mesh to cover the frame of the coop. However, we found through an interview with a local farmer that raccoons, especially, can get pry through and reach the chickens. Hardware cloth, a galvanized steel mesh with shorter width, is a good substitute that can be used instead of the chicken wire to keep the chickens safe.

Another important consideration is to have roofing for the coop to protect the chickens from aerial threats such as hawks. Roofing must also keep the chickens safe from environmental hazards, such as heavy rains. The roof needs to be slanted in some way to prevent the



Figure 4: Moving a mobile coop

Image courtesy of Pam Raymond

## Designing a Mobile Chicken Coop

accumulation of water to drip down on the chickens. The other hazard is the heat during hot summer days. Metal has a high thermal conductivity and can reach extreme temperatures on a very hot day. The combination of high temperatures and high humidity can be fatal to the birds. If metal is being used, it would be best to cover it with a reflective paint to lessen the amount of heat. This led us to using a hoop as a roof for our mobile coops which would offer sufficient protection while also giving the chickens enough ventilation to remain healthy.

Having a mobile chicken coop that is easily portable is an important factor for the success of the coop. We found that using tires for the mobile chicken coops would be most beneficial because farmers may have to deal with rough terrain. Without tires, it can be cumbersome to maneuver a coop across a rocky pasture. Other chicken coops require a dolly to move because they have no built in wheels and it usually requires two people. We learned from Jack Kittredge and Julie Rawson, our sponsors for Northeast Organic Farming Association, that this can be problematic because some small scale farmers work alone and need to be able to move the coop by themselves. Pneumatic tires would be the best option in terms of wheels because it allows the coop to be moved more easily. Also, because of feasibility and protection, our mobile chicken coop designs incorporated retractable wheels. This allows a farmer to easily set the coop in position to move, but when the coop is in a resting position, it would leave no gap for predators to crawl under.

In addition to portability and protection, proper sizing of the coop needs to be taken in



Figure 5: Photographs of Pam Raymond's fully enclosed mobile coop



## Designing a Mobile Chicken Coop

consideration. Chickens need to feel safe and content in order for them to be at their full potential so that they can grow more optimally and lay eggs in a consistent manner. If the coop is too small---less than 2 square feet per chicken---the chickens can get cramped and even fatally injured. As for weight, the coop needs to be relatively lightweight so it can be moved without too much effort by the farmer, many of whom we've learned, at least in central Massachusetts, are likely to be women. However, the coop can't be too lightweight or it will blow away or turn on its side during a strong gust of wind. This is the primary reason why our designs opted for wood rather than PVC piping. All these important factors have influenced our designs in some way.

Our first design is the hoop coop (See Figure 6) that is 10'x6'x4.5'. This design has a wooden base and utilizes aluminum poles to make the distinct arched roof. The coop will be covered in hardware cloth with a 6ml plastic covering stretched over it. This is not depicted in the image due to the software used being incapable of modeling it. The plastic starts at 2ft off the ground to help with ventilation and the entire back end is covered to provide a protected side in case of bad weather.

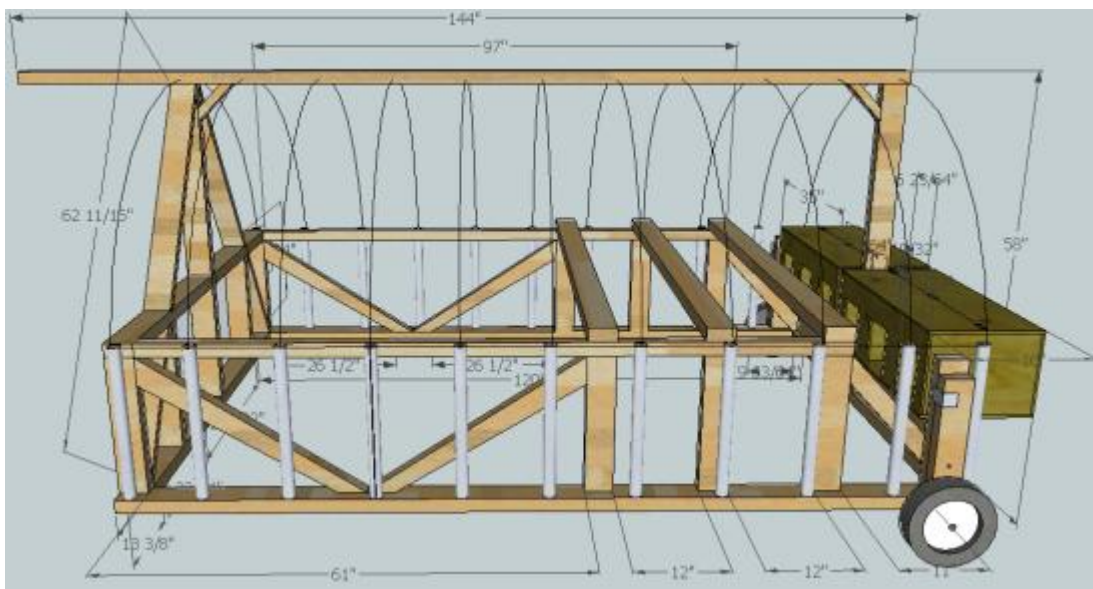

Figure 6: Hoop coop design

Important features include:

- 10'x6'x4.5' mobile coop with space for six 1'x1'x16" egg boxes
- Two rear retractable 8" diameter 2.5" thickness solid plastic wheels

## Designing a Mobile Chicken Coop

- One front handle/lever arm for maneuvering the coop
- Three roosts that span the coop
- Two 18"x24" doors on the front side of the coop. These fit into the existing triangular bracing see in Figure 6.

Our second design is a hybrid between a Salatin style coop and a hoop coop. Joel Salatin is an American organic farmer, author of several books, and many farmers use his chicken tractor design as model. The Salatin model is a 10' x 12' x 2' high coop and is usually moved by a two-wheel dolly. However, these coops are generally considered restrictive in the amount of space available for the chickens. To solve this,

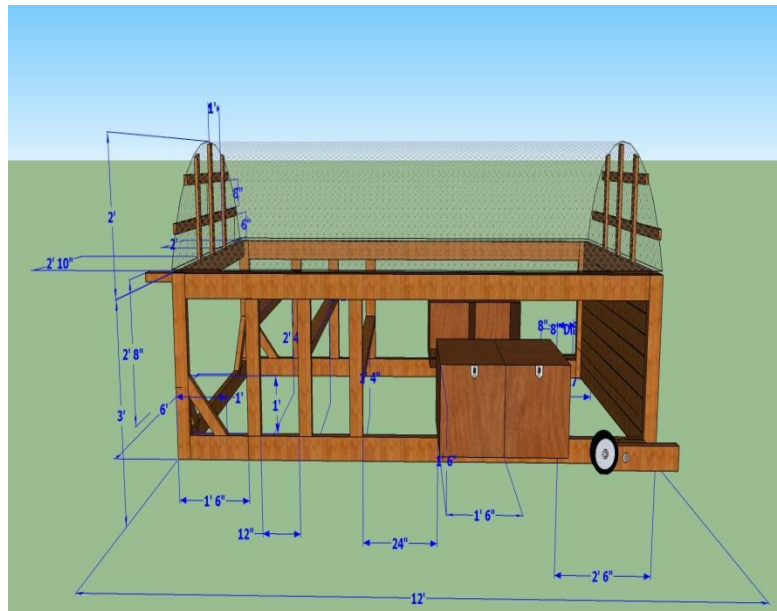

Figure 7: Hybrid Hoop Coop

this design incorporated a hoop to give the chickens more room to both roost and forage.

This design includes the key benefits of a hoop coop along with the stability and structure of a standard chicken coop. It offers 4 nesting boxes which could house around 20 chickens. Staggered roosts are introduced to exchange the vertical height for more space underneath. Cattle panel (feedlot panel) is used for the 2' high hoop which offers both protection and extra ventilation. It includes a fully enclosed side with a door to protect the coop and chickens from strong winds. A handle runs across the middle of the coop and 2' past the back so that the coop can be lifted up and positioned. Retractable wheels are used for safety and ease of portability.

Important features include:

- 12'x6'x5' mobile coop with space for four 1'6"x1'6"x2' egg boxes
- Two rear retractable 8" diameter 2.5" thickness wheels



## Designing a Mobile Chicken Coop

- One front handle/lever arm for maneuvering the coop
- Three staggered roosts
- One 32" x 28" door
- 2' high hoop using cattle panel

Our last design is a fully enclosed coop for movable pens (See Figure 8). The purpose of the movable pen is to add an extra layer of protection against land and aerial predators. This also allows the chickens to range within the confines of the pen during the day, while being kept in the coop at night.

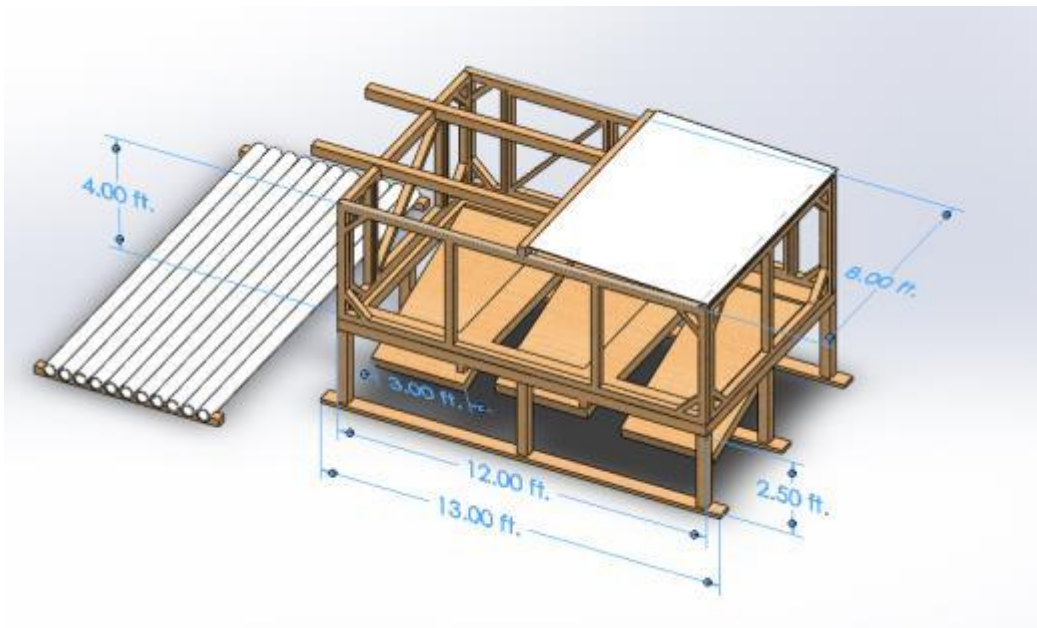

Figure 8: Fully enclosed coop design

This coop serves as a protected resting place during the night for the chickens. During the day, the flock is allowed free range within the mobile pen and is not limited to the mobile coop. The coop consists of a wooden frame, wooden supports, and also a wooden floor that drops down, allowing for easy cleaning. The entirety of the coop is surrounded by hardware cloth for extra protection. The movement system used for this coop is a PVC piping system with attached runners on the bottom of the coop which allows for smoother transitions. The owner of the coop would use the handles to lift the coop onto the PVC where it will slide across and relocate to a new location.

## Designing a Mobile Chicken Coop

Important features include:

- 12'x8'x4' mobile coops with space for five 1'x1'x15" egg boxes
- PVC wheel system
- Two roosts that laterally span the coop
- Two front handles/lever arms for maneuvering the coop
- One 4'x4' door and two 3'x4' doors on the front and side respectively
- Drop down flooring. Three sections drop down, each measuring 3'x6'

### Authorship



Keegan Cole was the co-author of the introduction and the short report, Building a Mobile Chicken Coop, for use by our sponsor, the Northeast Organic Farming Association (NOFA). In addition, he was responsible for compiling and formatting all of the references we used throughout the project. He also was the designer for the hoop coop and wrote the corresponding section for it in the Designs chapter.

Lindsey DeLuca was the primary author of the Findings chapter and Acknowledgements page. She was a co-author for the Methodology chapter and made the Pros and Cons Table for Materials in Appendix D. In addition, she was the designer for the fully enclosed coop and wrote the corresponding section for it in the Designs chapter.

Kimberly Zielinski was the primary author of the Authorship page. She was a co-author for the Methodology chapter and had the responsibility of editing the methodology chapter. In addition, she was responsible for compiling the appendices and formatting the paper. She was also the designer for the hybrid hoop coop and wrote the corresponding section for it in the Designs chapter.

The Abstract, Executive Summary, and Background Chapter were written together as a group effort. There was equal contribution from each group member for Appendix C and in editing the Introduction. In addition, the group worked together to make the brochure for the NOFA Conference.

## Table of Contents

Abstract.....	ii
Acknowledgements .....	iii
Executive Summary .....	iv
Authorship .....	xi
List of Tables and Figures .....	xiv
1. Introduction.....	1
2. Background and Literature Review.....	4
2.1 Benefits of Raising Chickens for Farmers .....	4
2.2 Collaborating with NOFA.....	7
2.3 Importance of a Mobile Chicken Coop and its Key Components .....	9
2.4 Challenges Associated with Designing a Mobile Chicken Coop .....	17
3. Methodology .....	20
3.1 Identify Key Design Parameters for End Users.....	20
3.2 Develop Designs Based on Preliminary Research and Interviews .....	23
3.3 Build Prototypes .....	25
3.4 Distribute Information and Design Ideas .....	25
4. Findings .....	28
4.1 Analyses of Organic Standards and Their Effect on Farming.....	28
4.2 Needs of NOFA Farmers .....	30
4.3 Analyses Regarding the Structure of a Mobile Chicken Coop.....	31
Finding 1: Ventilation is necessary in any chicken coop design and without it the health of the chickens are at risk.....	31
Finding 2: Both aerial and land predators serve as an immense threat to the flock, therefore, adequate protection is necessary in the mobile chicken coop design. ....	32
Finding 3: Movement is a very important component of a mobile chicken coop and must be considered during the design process.....	36

# Designing a Mobile Chicken Coop

Finding 4: The inside structure of the mobile chicken coop is vital to the happiness and overall health of the poultry.....	38
4.4 Optimum Materials and Tools.....	40
5. Designs .....	43
5.1 Hoop Coop .....	48
5.2 Hybrid Hoop Coop .....	57
5.3 Fully Enclosed Coop.....	65
6. Concluding Remarks .....	76
6.1 Who this Appeals to:.....	76
6.2 Improvements to Mobile Chicken Coops:.....	76
6.3 Future Projects and Research: .....	77
References.....	80
Appendices.....	82
Appendix A: Interviews.....	82
A.1 Interview with Jack Kittredge.....	82
A.2 Notes from Interview with Pam Raymond .....	85
A.3 Notes from Interview with Jassy Bracko.....	88
Appendix B: Pros and Cons of Different Materials.....	90
Appendix C: Original Design Sketches .....	91

## List of Tables and Figures

### Tables:

Table 1: Pros and Cons for the Hoop Coop .....	52
Table 2: Hoop Coop Materials List .....	55
Table 3: Pros and Cons of the Hybrid Hoop Coop.....	<b>Error! Bookmark not defined.</b>
Table 4: Materials for the Hybrid Hoop Coop .....	63
Table 5: Pros and Cons for the Fully Enclosed Coop.....	<b>Error! Bookmark not defined.</b>
Table 6: Materials List for the Fully Enclosed Coop .....	73

### Figures:

Figure 1: Mobile Chicken Coop.....	iv
Figure 2: Salatin Coop .....	iv
Figure 3: Threat of predation .....	v
Figure 4: Moving a mobile coop .....	v
Figure 5: Photographs of Pam Raymond's fully enclosed mobile coop .....	vi
Figure 6: Hoop coop design.....	vii
Figure 7: Hybrid Hoop Coop .....	viii
Figure 8: Fully enclosed coop design .....	ix
Figure 9 Benefits of Organic Farming .....	1
Figure 10: Organic Chicken Farming .....	4
Figure 11: Hens' Pecking Behavior .....	5
Figure 12: Free Range Chickens .....	6
Figure 13: Jack and Julie's Coop .....	7
Figure 14: Jack and Julie's Coop .....	8
Figure 15: Protection in a Mobile Chicken Coop.....	10
Figure 16: Nesting Box.....	11
Figure 17: Retractable Wheel System .....	11
Figure 18: Example of Ventilation in Mobile Coop.....	12
Figure 19: Untreated Wood .....	13
Figure 20: PVC Panel Roofing .....	14
Figure 21: Chicken Wire and Hardwire Cloth .....	14
Figure 22: Jarhead Coop Design .....	15
Figure 23: Salatin Model .....	15
Figure 24: Gwendellano Coop .....	16



## Designing a Mobile Chicken Coop

Figure 25: Birdinbethel's Coop.....	17
Figure 26: Difficulties with Movement .....	17
Figure 27: Jack Rawson's Salatin Coop.....	21
Figure 28: Pam Raymond's fully enclosed coop in a movable pen.....	22
Figure 29: One of Jassy Bracko's Mobile Coops .....	23
Figure 30: Hoop Coop Preliminary Drawing.....	24
Figure 31: Hybrid Hoop Coop Preliminary Drawing .....	24
Figure 32: Fully Enclosed Coop Preliminary Drawing .....	25
Figure 33: Chicken Feces as Fertilizer .....	28
Figure 34: Open Floor Plan.....	29
Figure 36 Full-time Farm.....	30
Figure 37 Coop with Ventilation.....	31
Figure 38 Coop with Hardware Cloth .....	34
Figure 39 Protection from Digging .....	35
Figure 40 Dolly Movement System .....	36
Figure 42 Four Wheel System.....	37
Figure 41 Two Wheel System.....	37
Figure 43 Egg Boxes with Privacy .....	38
Figure 44 Round Feeder .....	39
Figure 45 Circular Saw.....	40
Figure 46 Front Door of Prototype.....	41
Figure 47 Side Doors.....	42
Figure 48: Objective Tree .....	44
Figure 49: Pairwise Comparison Chart.....	45
Figure 50: Graph of Pairwise Comparison .....	46
Figure 51: Hoop Coop .....	46
Figure 52: Hybrid Hoop Coop .....	47
Figure 53: Fully Enclosed Coop.....	47
Figure 54: Cattle Panel Hoop.....	48
Figure 55: Retractable wheel system.....	49
Figure 56: SketchUp Hoop Coop Full View.....	50
Figure 57: Sketchup Front View .....	51
Figure 58: SketchUp Hoop Coop Side View .....	51
Figure 59: SketchUp Hoop Coop Rear View.....	52

## Designing a Mobile Chicken Coop

Figure 60: Hoop Coop Model Full View.....	53
Figure 62: Retractable Wheel System 1 .....	54
Figure 61: Retractable Wheel System 2 .....	54
Figure 63: Hoop Coop .....	58
Figure 64: Salatin Pen.....	58
Figure 65: Full View of Coop.....	58
Figure 66: Wheel System.....	60
Figure 67: Staggered Roosts .....	61
Figure 68: Hoop Section.....	61
Figure 69: Fully Enclosed Coop.....	66
Figure 70: Drop Down Flooring.....	67
Figure 71: Personal Design, Drop Down Flooring.....	67
Figure 72: Personal Design, Structure of the Coop.....	68
Figure 73: Chicken Wire and Hardware Cloth.....	69
Figure 74: Movable Pen.....	69
Figure 75: Roller System.....	70
Figure 76: PVC Wheel System Design .....	70
Figure 77: Hoop Coop First Sketch Full View .....	91
Figure 78: Hoop Coop Final Sketch Full View.....	92
Figure 79: Wheel System Sketch .....	93
Figure 80: Hoop Coop Sketch Front View .....	93
Figure 81: Hoop Coop Sketch Back View.....	94
Figure 82: Hoop Coop Sketch Side View.....	94
Figure 83: Hybrid Hoop Coop Sketch Roost .....	95
Figure 84: Hybrid Hoop Coop Sketch Top.....	95
Figure 85: Hybrid Hoop Coop Sketch Staggered Roosts .....	96
Figure 86: Hybrid Hoop Coop Sketch Wheel System.....	96
Figure 87: Hybrid Hoop Coop Sketch Door .....	97
Figure 88: Fully Enclosed Coop Sketch .....	98
Figure 89: Fully Enclosed Coop Sketch Sides.....	99
Figure 90: Fully Enclosed Coop Sketch Front and Rear View .....	100
Figure 91: Fully Enclosed Coop Sketch Bottom.....	101
Figure 92: Fully Enclosed Coop Movement System.....	102

## 1. Introduction

The global use of biological resources—humanity’s “ecological footprint”—exceeds the capacity of the world’s land and seas to create or renew those resources.<sup>1</sup> Because the agriculture sector uses the largest amounts of land, scientists as well as the general public have been seeking alternative ways of farming in order to increase its efficiency and ensure a bright, environmentally-friendly future. After becoming more aware of the hazardous effects that conventional farming practices may have on the environment and the need for more sustainable farming, many farmers across the world are starting to turn towards organic farming techniques as their main method of farming. The organic system does not use synthetic chemicals, but instead, mimics natural systems, thus using less energy and decreasing human dependence on nonrenewable resources. Rodale Institute, located in Kutztown Pennsylvania, has been performing a study comparing organic and conventional farming practices side-by-side since 1981. Their results have found that when considering soil health, yields, economic viability, energy usage and human health, organic farming practices excel compared to their conventional counterpart.<sup>2</sup> Figure 1 shows the results as concluded by Rodale Institute, which proves the positive impact organic farming has on both the environment and farmers’ finances. The positive influence exhibited by organic

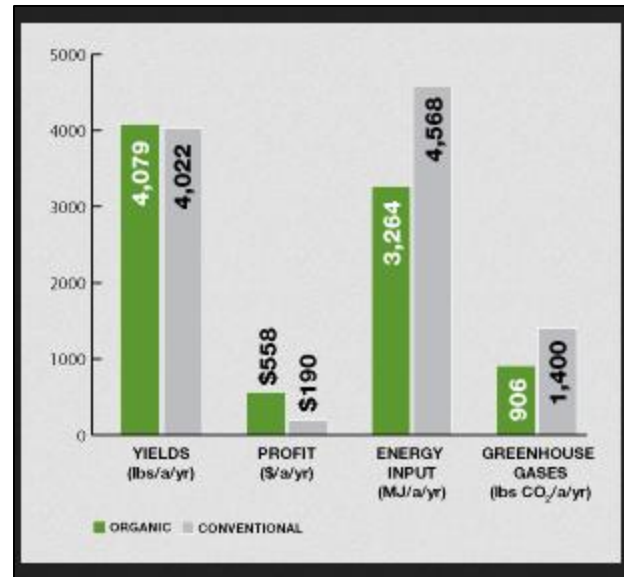

Figure 9: Benefits of Organic Farming

<sup>1</sup> Craig J. Pearson. "Regenerative, Semiclosed Systems: A Priority for Twenty- First-Century Agriculture." *BioScience Magazine*. 57.5(2007): 409-418.

<sup>2</sup> Rodale Institute. "Farming Systems Trial: 30-Year Report." N.p., n.d. Web. 13 Feb. 2014.

## Designing a Mobile Chicken Coop

farming has become known by farmers everywhere, as the number of organic farms has increased from 1 million acres in 1990 to over 4.1 million today.<sup>3</sup>

Organic chicken farming has experienced a surge in popularity in the last decade as full-time farmers, self-sufficient farmers and even hobbyists began to search for other methods of raising poultry for market and for home consumption. A number of factors can explain this growth. Chickens, in addition to being both a source of income and food, can reduce the costs in other areas of farming.<sup>4</sup> Chickens help reduce the number of pests in the field while their feces act as a fertilizer. This is desirable to both large scale farmers and independent hobbyists. Another factor is the shift towards eating more local, fresh, healthy food. People have become concerned with the amount of pesticides that can be in foods and the excess of antibiotics given to animals that are raised for consumption. In addition, awareness to inhumane conditions for some of the commercially raised animals has become evident.<sup>5</sup> This rise of organic chicken farming practices has caused many farmers to look towards alternative methods of rearing chickens both as a means to improve animal welfare and to benefit the environment and their land.

However, farmers and hobbyists encounter problems with allowing chickens to be free range. It makes them prime targets for predators, which can result in many deaths among the flock. Even when housed in a coop, there is still a threat of predators. Many coops use chicken wire as a means of protection, but it does not prevent predators, such as raccoons, hawks, or owls, from attempting to reach in and pull chickens out of the coop. This is especially hazardous for fledglings on account of their small stature. In addition, chickens in an open bottom coop are especially at risk due to predators being able to dig under and into the coops.

Mobile chicken coops for organic farming can be difficult to build because of the inability to use chemically treated building materials, such as pressure treated lumber. There is no specific regulation that prohibits the use of treated lumber in organic farming, but the substances in it cannot come in direct contact with organic livestock or soil that will be used to grow organic

---

<sup>3</sup> Cohn, Meredith. "USDA Takes Accounting of Organic Farms." *Chicagotribune.com*. The Baltimore Sun, 2014. Web. 13 Feb. 2014.

<sup>4</sup> Uses For Chickens. (n.d.). - *Raising Chickens*. Retrieved October 3, 2013, from <http://www.wilderness-survival.net/uses-for-chickens>

<sup>5</sup> Schassler, Kathleen. "Farms Sow More Organic Acres, As Demand Rises." *Connecticut Health Investigative Team*. N.p., 27 Feb. 2014. Web. 05 Nov. 2013.

## Designing a Mobile Chicken Coop

crops. Though organic farming addresses the problem of curbing human reliance on nonrenewable sources of energy, the higher standards of organic farming, such as the disallowance of chemicals, can pose problems organic farmers will have to overcome.

As an alternate to raising free range chickens, many organic farmers have turned to using mobile chicken coops with untreated wood as their main building material. One common model is the Salatin model which is a short rectangular mobile coop aimed to be easy to construct and move. However, there are many gaps in this particular model of a mobile chicken coop since untreated wood easily rots, which requires large amounts maintenance, and the coop does not provide adequate protection from extreme weather and predators due to having no solid sides and an open bottom. In order to address the downfalls of this model and improve upon mobile chicken coops in general, more designs must be created which fulfill organic standards while also preserving the happiness and lives of the chickens being raised.

The Northeast Organic Farming Association, NOFA, is our sponsor for this project. The organization wants to not only bring attention to the positive aspects of raising chickens but also to design a more robust, portable, easily assembled mobile chicken coop without using toxic materials such as pressure treated wood, but to build an better. Our goal for this project was to work with local chicken farmers in order to first understand their needs for an effective and secure mobile chicken coop and then to incorporate these ideas into relevant mobile chicken designs. To achieve this, our team interviewed local farmers, visited farms to acquire first-hand accounts of successes and failures of previous mobile chicken coops. Based on the information we received and our background research, we designed and built three blueprints and prototypes in a hope to satisfy the needs of the farmers and their chickens.

Each design targeted one aspect of mobile chicken coops. The first design, a hoop coop design, focused on finding a way to house more birds in a healthy environment and in a small footprint. The second design, a hybrid hoop coop, aimed to combine the structural integrity of a low laying rectangular coop with the preferable height of a hoop coop. The last design, a fully enclosed coop, was meant to be a way to protect against predation in a way that open bottom mobile coops could not. Two of the designs were made into prototypes, the hoop coop and fully enclosed coop, to help determine not only what problems they solved but the ones they faced.

## 2. Background and Literature Review

We begin this section by detailing the reasons why raising chickens can be beneficial for organic farmers or those interested in raising chickens as a hobby. We then explain why there is a need for an improved mobile chicken coop and describe the typical components and materials found in successful mobile coops. Lastly, we consider challenges and trade-offs in relation to constructing and using a mobile chicken coop.

### 2.1 Benefits of Raising Chickens for Farmers

Organic chicken farming, on both large and small scales can help support more sustainable farming practices. Chickens are not only a source of income and food, but can also reduce costs in other areas of farming.<sup>6</sup> They are versatile and easy to take care of, making them a low effort but high impact solution to some of the problems people face, such as the high cost of feed and maintenance of other livestock, in creating sustainable agriculture systems.



Figure 10: Organic Chicken Farming

Source: <http://neighborsmarkets.com/a-thirty-dollar-chicken/>

There are many benefits of raising chickens organically on a small scale. Small scale farming can range anywhere from a person owning one chicken in their backyard to a small farm that may rely on raising chickens for part of its income. A couple of the more obvious benefits of raising your own chickens are the fresh eggs and meat. One hen can lay one egg almost every day during the summer but most chickens generally lay three to five eggs per week which means a couple of birds will be plenty to keep a small family in stock of eggs all summer long . During the winter chickens may stop laying eggs all together due to shorter days and the lack of sunlight. The hens are typically kept

---

<sup>6</sup> Uses For Chickens. (n.d.). - *Raising Chickens*. Retrieved October 3, 2013, from <http://www.wilderness-survival.net/uses-for-chickens>



## Designing a Mobile Chicken Coop

during the winter as long as they are provided with heat and sunlight. Broilers, on the other hand, are marketed usually around the 10 week mark since they are fully matured by weeks 6-8.

Raising meat birds on a smaller scale, however, does require quite a bit more planning ahead than raising layers in order to assure that your flock is being replenished quickly enough.

Chickens can also be a source of free energy with some of their natural instincts. When left out on their own, chickens will help graze a field or yard in search of grubs and bugs that are usually viewed as pests.

By releasing chickens in a garden, they will help loosen the topsoil by all the scratching and pecking they do which will therefore, get rid of grubs in the soil that might damage the produce being planted.<sup>7</sup> This saves time and effort in preparing to plant fruits, vegetables, or flowers. Raising chickens on a larger scale has different benefits that impact sustainability. Chickens, as mentioned before, love eating bugs when given the chance. If large farms integrated chickens with their cattle, the chickens could help keep the cows healthy by reducing the number of ticks coming in contact with them. This reduces medical cost that might otherwise be needed for the cattle which in return, saves the farmers some money. Preventing medical issues is also beneficial for the cattle by allowing them to avoid stress with medication after they have already contracted an illness.

According to Joel Salatin, a farmer and expert in raising free range chickens, farmers need to decide on two issues to run an effective poultry business: 1) the type of production system they will use, such as allowing the flock to free range or keeping them in mobile coops; and 2) how they plan to process their bird, such as their plans for constructing a chicken coop or what type of protection they will use if they allow their chicken to graze freely.<sup>8</sup> For Salatin, the



Figure 11: Hens' Pecking Behavior

Source: <http://animals.pawnation.com/reason-hens-picking-other-4371.html>

---

<sup>7</sup> Pest Eating Chickens Play Role in Creating Sustainable Agriculture Systems. (n.d.). *Seedstock*. Retrieved October 4, 2013, from <http://seedstock.com/2012/08/12/pest-eating-chickens-play-role-in-creating-sustainable-agriculture-systems/>

<sup>8</sup> Muntz, S. (n.d.). Opportunities in the Evolving Range/Pastured Poultry Industry. *Heifer Project International*. Retrieved October 4, 2013, from <http://www.nal.usda.gov/afsic/nsfc1999/Steven+Muntz.pdf>

## Designing a Mobile Chicken Coop

key, regardless of how the coop is constructed, is making it light enough to move but heavy enough to resist the wind. He used Cornish-White Rock cross chickens in his system because of their ability to grow rather rapidly. Because these types of birds do not like to forage, this system would be most beneficial in a short pasture. His pens are 10' x 12' x 2' high and it is said to hold between 85-90 chickens. Some people believe that there is not enough room for the chickens to move around inside the coop and that it is "too restrictive." Salatin states that these birds do not roam that much at all so the extra room is not needed. The benefits of this system are that farmers can raise a large number of meat birds while also allowing the chickens to provide a high



Figure 12: Free Range Chickens

Source: <http://manhattaninfidel.com/2011/04/21/morale-low-among-free-range-chickens/>

amount to a lot of money. The chickens help pay for themselves by laying eggs or providing meat down the line. Therefore, chickens perform an almost entirely free service that can greatly benefit the lifestyle of farmers.

There are some benefits of owning and raising chickens that influence both smaller and larger scales of farming. Chicken excrement, as with most other farm animals', can be used as a fertilizer for gardens or fields. Some people mix it into their compost while others use it alone. However, unlike other animals, chicken excrement does not need to be aged before use and can be used immediately as a fertilizer without it burning the plants. This saves time, effort, and money for anyone who owns chickens and grows any sort produce.

concentration of manure to the soil. However, this system does not take in account farmers who rely on raising hens or forage dominant birds for profit.

In addition, when chickens are released into apple orchards they reduce the number of apple sawflies. When chickens are released around pear trees, they reduce the potential for skin damage to the fruit from midges. Apple sawflies and midges are two very common problems in orchards.<sup>2</sup> Chickens are a solution that do not involve harmful chemicals or

## Designing a Mobile Chicken Coop

The quality of the chicken's diet directly impacts the quality of their eggs. It is important for the chickens to have a healthy diet of eating grubs, beetles, and ticks in order for the eggs to have a sufficient amount of protein.<sup>9</sup> Chickens that are fed naturally produce eggs that taste slightly better according to consumers. Having a proper diet for the chickens ensures that the eggs will receive all the important nutrients they need. Consumers, knowing their eggs came from happy and healthy hens, will find it pleasing to know that their eggs are natural compared to industrial methods of feeding chickens.<sup>10</sup>

Specifically the roles that chickens play in sustainable agriculture are replenishing nutrients in the soil and insect control. By rotating crops and animals, farmers are able to replenish most of the nutrients in the soil that get used up over time by the produce they are growing. This reduces the need for soil enrichers and saves both time and money. As mentioned earlier, chickens are a great method for insect control without needing to use possibly damaging pesticides which will reduce costs and save effort in return.

### 2.2 Collaborating with NOFA

For this project, we collaborated with our sponsor, the Northeast Organic Farming



Figure 13: Jack and Julie's Coop

Association of Massachusetts (NOFA-Mass), who was interested in new design ideas for a mobile chicken coop. NOFA originally formed in 1971 in both Vermont and New Hampshire, with Massachusetts chapters being added in 1982, subsequently establishing NOFA-Mass. Today, NOFA-Mass works closely with farmers, gardeners, landscapers and consumers to help educate anyone in the Northeast interested in

<sup>9</sup> Feeding Chickens. (n.d.). – *Wilderness Survival*. Retrieved October 7, 2013, from <http://www.wilderness-survival.net/feeding-chickens/>

<sup>10</sup> Grover, S. (2011, March 7). Organic Eggs May Have The Same Flavor As Conventional, But They Still Taste Better. *TreeHugger*. Retrieved January 27, 2014, from <http://www.treehugger.com/green-food/organic-eggs-may-have-the-same-flavor-as-conventional-but-they-still-taste-better.html>

## Designing a Mobile Chicken Coop

organic agriculture. Any type of individual who grows food, ranging from small to large, or urban to rural is welcome into this organization. NOFA's main mission is to promote a healthy community by educating individuals about the significance and importance of organic farming systems. NOFA members and staff provide advice on farming methods and gardening, emphasizing an eco-friendly alternative to synthetic fertilizers and pesticides.

NOFA members understand the benefits of rearing free range chickens, both as potential revenue stream and as a means to fertilize fields naturally and to reduce pests. To expand opportunities for its members, NOFA asked us to develop a design for a viable mobile chicken coop, without incorporating into the design toxic materials such as pressure treated wood which would pose problems for organic farmers. NOFA executive director, Julie Rawson and policy director, Jack Kittredge, have been working for NOFA since the 1980s. We visited their farm, called Many Hands Farm, in the fall of 2013 to learn more about their reasons for raising chickens and to see first-hand their coops. While visiting, we learned the pair is currently raising meat birds, layers, and even turkeys. They were kind enough to show us their mobile coops and enlighten us on the major issues with their present models, which were designed after Salatin style model - they are 8' x 12', constructed out of wood, and can hold up to about 35 adult birds.

The coops Jack and Julie utilize have a unique method of mobility, since there is no established wheel system. Instead, they use a dolly system, requiring two people: one person lifts the coop and ensures the chickens do not escape, while the second person controls the dolly. On these coops are roosts which act as handles to aid in movement, providing a lever in which to easily lift the coop.



Figure 14: Jack and Julie's Coop

Because Jack and Julie raise three different breeds of birds, turkeys, layers and meat birds, their coop designs slightly vary for each type. Since turkeys are heavier and like to roost



## Designing a Mobile Chicken Coop

more often than chickens, roosts are an important aspect of their turkey coop design, requiring adequate thickness in order to support the load applied by the large birds. For layers, Jack and Julie's chicken coops need to have a form of nesting in which their chickens can comfortably lay their eggs. They use both built in nesting boxes and milk crates for the collection of eggs, though a hatch in the back of the nesting boxes makes this particular style more ideal than milk crates since farmers can have easier access to the eggs. Meat birds require no special accommodations making their coop design extremely simple.

Although the interior of the coops vary for each type of bird, all birds need protection from outside predators in order to ensure their safety. For protection, Jack and Julie use chicken wire to surround the frame of the coops and corrugated sheet metal for their roofs. They also use dogs to scout the perimeter of the farm and protect the flock from any potential animalistic dangers, such as coyotes and raccoons.

### **2.3 Importance of a Mobile Chicken Coop and its Key Components**

A big decision farmers face involves the style in which to raise their poultry. Some organic chicken farmers allow their poultry to free-range, which is described as a system where animals can roam freely to scavenge for food. Although this provides sunlight and fresh air for the chicken, there is not adequate protection from predators and diseases. Farmers may also decide to keep their chickens enclosed in coops. While this system does provide more protection, the poultry are unable to scavenge for extra feed, nor can they spread their natural fertilizer across the land, causing enclosure to be much more expensive than its free-range counterpart. A good compromise for these two systems of sustainable chicken farming is the mobile chicken coop.

A mobile chicken coop is a movable home for poultry, which allows them to free range while also offering the protection that they need. Mobile chicken tractors provide many benefits, such as pasture diversification, pest removal, market garden operations and many others. A portable chicken coop offers an effective means to fertilize an entire pasture in a time efficient manner. Chicken manure does not have to be "aged" like manure from other animals, such as horses and pigs, but can be used right away without burning through plants. Thus, chickens provide free fertilizer which enriches the soil, while also cutting down on labor, as it saves farmers the chore of buying and spreading other types of fertilizers. Chickens also make a handy

## Designing a Mobile Chicken Coop

tillage tool due to their natural scratching, pecking and rooting behaviors. These simplistic instincts can lead to the consuming of excess weeds, grass and insects. Mobile coops allow poultry to scavenge for extra food, which cuts down on food costs as this extra feed makes up about a quarter of a chicken's diet.

Having a proper coop design is crucial for the success of small-farm enterprises. There are many different considerations to take into account when designing a chicken tractor for a small scale farm. Many different functions of a mobile chicken coop such as movement, size, cost and many others depend on the needs of the farmers as well as the particular situation which the farmers face. For examples, some operations, such as movement, depend on the elevation and contours of the land, while other functions, such as size, depend on the number of chickens in need of housing. Overall, mobile chicken tractors are dependent on many different factors and must be adapted to fit the specific needs of the farmers.

A mobile chicken coop must also defend against both inclement weather and dangerous predators.<sup>11</sup> Predator threats to poultry are both airborne, such as hawks and owls, and land-based due to coyotes and raccoons. Therefore, a mobile chicken coop must offer a good amount of protection from all angles. As seen in the image to the right, there are many different ways to protect a flock when using a mobile chicken coop, such as having a sturdy wooden frame or using hardware cloth around the perimeter. However, wild animals are not the only hazards that organic chicken farmers face. Weather can also be an issue, leading to disease and sometimes death among poultry. Surprisingly, cold weather does not have too much of an effect on chickens, as they can



Figure 15: Protection in a Mobile Chicken Coop

Source: <http://www.backyardchickens.com/a/raising-chickens-on-a-shoestring>

<sup>11</sup> Keppel, W. (n.d.). ManagingWholes.com. *Portable pens for pastured poultry: designs that beat heat, wind, and rain*. Retrieved January 22, 2014, from <http://managingwholes.com/poultry-pens.htm>



## Designing a Mobile Chicken Coop

withstand temperatures well below freezing. However, chickens dislike the rain and farmers have lost their chickens due to drowning from too much rainwater in the coop. Therefore, adequate roofing must be provided as well as a place for poultry to roost away from the wet and diseased floor.

In areas such as New England, farmers experience vastly different terrains, from bumpy hills to grassy flatlands. These different types of terrain must be considered when building a mobile chicken coop since movement can be greatly affected. For hilly contours, a farmer must ensure that the wheels can make it over the difficult mounds. Typically, for lands with more elevation and bumps, tires should have puncture resistance and stone ejecting tread as well as biting edges to help the coop claw up and over the hills. For flatter land, there are not as many constraints on which wheels to use, since there are not many obstacles to impede movement, therefore, any wheels that can support the chicken coop can work. We visited Pam Raymond, a farmer who works closely with NOFA to educate individuals on agriculture, and she told us that they use retractable wheels for their mobile coop that can lock in place when the coop is ready to be moved. This gives the advantage of keeping the chickens safe while the coop is stationary and allows for the coop to be easily portable.



Figure 17: Retractable Wheel System

Image courtesy of Pam Raymond



Figure 16: Nesting Box

Source: <http://www.backyardchickens.com/a/pictures-of-chicken-nesting-boxes-how-to-build-a-nest-box>

## Designing a Mobile Chicken Coop

Another function farmers need to recognize and address is the special features that must be added to the coop for the different types of poultry.<sup>12</sup> There are various types of poultry that an organic farmer can raise, and each class prefers different features in their mobile home. For layers, or chickens whose primary purpose is to lay eggs, coops will need to be equipped with a private nest for the eggs to be laid. The nests must also be protected from outside predators, especially rats, which enjoy stealing eggs. Many of these egg-stealing animals are also very small, so farmers must ensure that there are no gaps or cracks in the nest boxes that these pests can squeeze through. Farmers must also provide layers a place to roost, especially in rainy weather when the wet floor can carry many diseases.

Another breed of poultry is meat birds which tend to be the easiest to design for since they do not require any added luxuries. Meat birds are only raised for slaughter, so they do not need a nest to lay eggs, nor do they find roosting particularly favorable. Turkeys, on the other hand, enjoy roosting, but, since they are much heavier than egg layers, their weight must be taken into consideration when determining their roosting place. Furthermore, the roosts must be placed higher than the nest boxes or else the chickens will sleep in the nest boxes and foul them.

There are many different sized flocks that organic farmers can raise, from five chickens to five hundred, and mobile coop designs must be adapted accordingly. Humanely, each chicken should have at least two square feet of room to themselves. Ideally, however, to increase the happiness of chickens and overall productivity, three square feet should be provided. If chickens start to die for unexpected reasons, that is usually a sign that they do not have



Figure 18: Example of Ventilation in Mobile Coop

Image courtesy of Pam Raymond

---

<sup>12</sup> Wolpe, M., & McElroy, K. (2013). *Reinventing The Chicken Coop: 14 Original Designs With Step-by-Step Building Instructions*. Storey Publishing

## Designing a Mobile Chicken Coop

enough room in the coop or not enough ventilation. Ventilation plays an important role in any sized chicken home. Pam Raymond's coop has a vented back so that the chickens can remain cool during hot days in the summer. The inside of a chicken coop tends to be very damp and hot, so ventilation must be provided to ensure proper health of the poultry.<sup>13</sup> At minimum, there should be vent openings towards the top of the coop; however, additional openings are also preferred.



Figure 19: Untreated Wood

<http://mgerwing.wordpress.com/2010/05/24/wood-siding-barn-wood-vertical/>

Finally, the materials used to construct a mobile chicken coop dictate both its mechanical and functional properties. Organic farmers have a lot to consider when choosing materials to build their various structures on their farms. These materials need to be affordable, sturdy, and most importantly, safe for the soil and animals. The most common building material is untreated 2x4s. 2x4s are affordable, sturdy, and easy to build without using heavy duty power tools.<sup>14</sup> In addition, it is easy to find a lumber yard or home improvement store that sells them, which is useful if repairs are

needed. Another option could be PVC piping due to it being lightweight, strong, and not too expensive. It is also readily available at most hardware or home improvement stores as well as online.

A third material that was considered is aluminum piping. After doing some research it was found that it was not as readily available as untreated wood or PVC piping and much more expensive.<sup>15</sup> In addition aluminum piping weighs significantly more than the prior two options, making it a less desirable material.

---

<sup>13</sup> McConahey, M. (2013, April 26). Tips from the coop experts. *McClatchy - Tribune Business News*. Retrieved December 10, 2013, from <http://search.proquest.com/docview/1346151920>

<sup>14</sup> Wood as Construction material. (n.d.). *Civil Engineering*. Retrieved October 6, 2013, from <http://www.aboutcivil.org/Wood%20as%20construction%20material.html>

<sup>15</sup> Do It Yourself: Lumber Grades Explained. (n.d.). *Essortment*. Retrieved October 8, 2013, from <http://www.essortment.com/yourself-lumber>

## Designing a Mobile Chicken Coop

The materials that have been discussed so far would be used as the frame of the chicken coop itself. Another aspect that needs to be considered is the mesh that will surround the entire coop. The poultry netting needed to have a very small mesh pattern to keep chicks from sticking their heads through it, it needed to be structurally strong enough to protect the birds from predators, and needed to resist wear and tear to keep maintenance down. The most common option for poultry netting is galvanized steel. Farmers typically use chicken wire as their poultry netting but, after interviewing Pam Raymond, we found that this mesh is too big and raccoons can reach through. If individuals have problems with raccoons, we learned that using hardware



Figure 21: Chicken Wire and Hardware Cloth

Source: <http://www.backyardchickens.com/a/gsim-chicken-coop>

cloth offered a superior alternative. The last material that needs to be considered is what to use for the roofing of the coop. A lot of chicken coops have sheets of aluminum as the roofing which are heavy, expensive, and hard to cut. In addition, the aluminum roofing gets very hot during the summer time and is not necessarily the safest option for the chickens. One viable substitution is PVC roofing panels. They are cheaper, lighter, and more of an insulator than aluminum sheeting. PVC roofing panel may not be easier to build with than aluminum sheets due to the need for protective eyewear and mouth wear when cutting it, but it is a viable option when building any sort of chicken coop. Another option is to use cattle panel to cover the top of the coop in a hoop shape. If the chickens needed shade or protection from rain water, farmers would cover the cattle panel with a tarp.

In general, the materials used for a chicken coop, more specifically a chicken coop for organic farmers, are: kiln-dried Whitewood

cloth offered a superior alternative.

The last material that needs to be considered is what to use for the roofing of the coop. A lot of chicken coops have sheets of aluminum as the roofing which are heavy, expensive, and hard to cut. In addition, the aluminum roofing gets very hot during the summer time and is not necessarily the safest option for the chickens. One viable substitution is PVC roofing panels. They are cheaper, lighter, and more of an insulator than aluminum sheeting. PVC



Figure 20: PVC Panel Roofing

<http://www.plastics.gl/article.php?iid=15&aid=210q>



## Designing a Mobile Chicken Coop

stud, PVC pipes and 90 degree PVC elbow pieces, galvanized steel poultry netting, aluminum sheets, PVC roofing panels. Fasteners can include: nails, screws, zip ties, and PVC pipe cement.

When researching the different parameters stated above, our group discovered many mobile chicken coop designs, which greatly influenced our own ideas. The most widely utilized



Figure 23: Salatin Model

Source: [www.ibiblio.org/farming-connection](http://www.ibiblio.org/farming-connection)

design for portable tractors, is the Salatin model, created by Joel Salatin. This model, pictured to the left, is built with lightweight lumber, most like untreated softwood, and is usually moved by slipping a dolly under the back, then pulling a handle on the front. Salatin pens also use corrugated aluminum roofing,

though corrugated steel roofing can be used as an alternative. This coop is so widely utilized because of its ease of construction and ability to adequately house chickens with proper protection and ventilation. However, many farmers have also found issues when using a coop based on the Salatin model.<sup>3</sup> According to many farmers, this type of coop is very difficult to move, since they can weigh up to two hundred pounds due to the wood frame. The corrugated aluminum roofing, although light, can double the cost of the coop due to its high price and in some areas has to be special ordered. The short height of the coop not only limits the access that farmers have to their chickens, but also sacrifices the happiness of the chickens since they are unable to roost.



Figure 22: Jarhead Coop Design

Source: <http://backyardchickens.com>

## Designing a Mobile Chicken Coop

Another type of portable chicken coop design our group came across through our research was the jarhead coop. As seen from the image, this coop is very aesthetically pleasing, having four windows for ventilation, four wheels and a hatch for easy mobility and pop doors that slide up and down for access to the chickens. There is also thirty inches of space for the chickens to roost, as well as flooring made of chicken wire that adds extra protection from digging predators, but also allow the ground to be fertilized. Although there are many positive aspects to this coop, such as the large amount of protection due to the solid walls and chicken wire flooring, there are other aspects of the design that fall short. The four windows do not provide adequate ventilation, especially in extremely hot temperatures when the inside of the coop can reach well over a hundred degrees. This can negatively affect the health of the flock and even result in the deaths of many chickens. The four wheel system of movement also is not ideal since it is at risk of tipping on rocky or hilly terrain. This coop can also cost up to five hundred dollars, making it too expensive for many chicken farmers.



Figure 24: Gwendellano Coop

Source: <http://backyardchickens.com>

Another design that some farmers utilize is the Gwendellano coop, which is made up of two different structures, a mobile pen and a mobile coop. The frame of the coop is made out of cedar slab wood, a lightweight material that helps to stabilize the structure. For ventilation, there is a window near the bottom and small openings near the roof. There are also nest boxes located at either side as well as a roost that runs across the middle of the coop that ensure a happy life style for the chickens. This coop uses a wheel system in order to move, although the designer of this coop does not think the wheel system is adequate enough to create an ease of mobility. The designer for this coop also does not feel it can fully protect the chickens without guard dogs present, even though the structure of the coop is completely made out of wood.



## Designing a Mobile Chicken Coop

The last design researched by our group researched was Birdinbethel's coop, which is aesthetically pleasing much like the Jarhead coop design, but also very functional. There is a ramp located in the center that allows the chickens to travel up to a second level. This ramp can be removed to allow for easy mobility. The upper level contains chicken wire flooring so that droppings may still fertilize the ground and also has two removable roosts.



Figure 25: Birdinbethel's Coop

Source: <http://backyardchickens.com>

However, there are no nest boxes in the coop, so this design cannot be used for layers. There are also doors on both ends that allow access to the chickens, although the designer wished he put the doors in the middle to allow for easier placement of food and water. The primary drawback of this particular design is its difficult movement system. There are two wheels located in the back and two handles in the front which requires the coop to be lifted by two people, making it very inconvenient.

### 2.4 Challenges Associated with Designing a Mobile Chicken Coop



Figure 26: Difficulties with Movement

Image courtesy of Pam Raymond

One of the first challenges individuals face when using a mobile coop, is the ability to move it. Whether it is due to extreme weight or not having wheels, farmers sometimes find it difficult to move a coop across their pasture. While these two aspects can be controlled in the design of the coop, there are other factors out of the control of the farmer that can make moving a chicken coop much more laborious.

## Designing a Mobile Chicken Coop

Two of the major unmanageable culprits are the terrain and weather. The movement system for a coop will have to deal with high grass, ruts, rocks, contours, mud, etc. Hence, wheel size and placement are critical. Six to eight inch diameter wheels are most commonly used on large mobile chicken coops. The type of the wheel, solid plastic or pneumatic, is based on the type of terrain involved while the number of wheels is dependent on the type of motion desired by the farmer.

Weather can have a very unpredictable effect on moving a chicken coop. During a dry spell the ground will be very firm and the grass will be thinner and shorter which allows for a greater ease of movement. But once it rains the ground can become boggy and wheels will tend to sink in and increase the difficulty of moving a chicken coop.

Another design challenge is to construct the coop so farmers are able to see the chickens while moving it. This generally can be addressed by the placement of the wheels and handles, but that can affect the placement of other aspects of the coop, such as doors and egg boxes. In addition, the type of mobility desired, turning versus covering long distances, requires extra planning when choosing and building a mobile chicken coop. Once again, this can be accounted for by the number of wheels, the type of wheels, and the placement and type of handle.

A more difficult challenge faced when using a mobile chicken coop is the materials used to build it. The options available to use in building a chicken coop greatly vary for organic and inorganic farmers. Organic farmers have significantly fewer options for building materials due to not being able to use anything that may be harmful to the birds or leach chemicals into the ground. This means pressure treated wood is not an option due to the chromate copper arsenate that would leach into the soil, making it unsuitable for growing organic produce.

Untreated lumber is an option for organic farmers to use but present other difficulties. Untreated wood does not last as long as pressure treated wood and, except for cedar, begins to rot when its moisture content rises to about 20%.<sup>10</sup> This means that wood left in contact with the ground is going to rot if the ground is moist enough or if it rains which then leads to needing frequent maintenance. If a part of a mobile chicken coop was to fail while there were chickens in it and needed to be repaired, the repair would not be very difficult but relocating the chickens temporarily would be. Untreated wood would be the ideal material for most farmers if it were not for the regular maintenance and upkeep needed due to rotting.

## Designing a Mobile Chicken Coop

There are alternatives to using untreated wood, but they too present their own limitations. PVC piping is affordable, durable, and lightweight. However, according to Pam Raymond, in some cases it is too lightweight and can cause a range of problems from predators being able to knock the coop over to the coop blowing away on a windy day. While PVC piping can be weighed down, it is a challenge to evenly distribute that weight to keep the coop stable while moving it. Aluminum piping is the longest last out of the materials mentioned but has more downsides than positive aspects. Aluminum piping is as heavy, if not heavier than untreated wood, and much more expensive. In addition, special tools would be needed in order to cut the piping to size and welding might be needed to secure the chicken coop together.

After conducting our background research, we learned that successful mobile chicken coops were dependent on certain criteria. Mobile coops that worked best for organic farmers were lightweight and could be moved with minimal effort. Other important factors that farmers stressed were proper protection from predators and the environment. While these criteria were found to be most important for farmers, the mobile coop also needed to have the basic necessities for raising chickens such as roosts and egg boxes. This led us to establish our design parameters and decide how to start designing a mobile coop.

### 3. Methodology

The goal of our project was to work collaboratively with local farmers to develop multiple mobile chicken coop designs that meet the different needs of organic farmers, homesteaders, and backyard growers. With the help of the Northeast Organic Farming Association (NOFA), who serves as our sponsor, we employed an iterative design process to develop designs, build prototypes, and receive feedback to further improve on our ideas and products. Below we have provided a series of objectives that will allow us to achieve the main goal of this project.

- **Collaborate with NOFA members to identify key design parameters** for end users.
- **Develop designs** based on preliminary research and interviews with local organic poultry farmers.
- **Build prototypes** to determine strengths and weaknesses of the designs.
- **Distribute information and design ideas** through NOFA to allow organic farmers to gain access to our ideas and designs.

This chapter specifies the approach we followed in order to complete the objectives mentioned above and produce a successful project that can be utilized by many organic farmers.

#### 3.1 Identify Key Design Parameters for End Users

As noted in our background chapter, there are a wide variety of mobile chicken coops readily available for purchase online (See page 4). Designs ranged from simple and lower quality, which are fairly affordable, to aesthetically pleasing and sturdy, but extremely expensive. In order to address this gap, our team researched the various functions of a chicken tractor (movement, protection, materials, etc.) and sought to learn how to optimize these components in an effort to produce a mobile chicken coop that is structurally sound, a means to protect against predation, and inexpensive in comparison to other premade models. To identify these key parameters and understand the tradeoffs between, for example, sturdiness and weight, or protectiveness and cost, we interviewed three different sets of local organic farmers to: 1) learn about their own chicken tractor designs; 2) discuss what improvements they wanted to see; and 3) brainstorm about possible ways to go about building our own designs. Some of the

## Designing a Mobile Chicken Coop

questions we asked them were: What kind of materials did you use to build your chicken tractors? How many of each kind of bird (layers, meat birds, turkeys, etc.) fit into your tractors? What are measures you have taken against predation? (See Appendix B for our entire interview protocol.)

The first interview we had was with Jack Kittredge and Julie Rawson from Many Hands Farm in Barrie, MA. Jack Kittredge is the policy director and the editor of NOFA publication, *The Natural Farmer*, while Julie Rawson is the executive director and education director of the organization. Jack and Julie had multiple Salatin style open bottom chicken tractors, see Figure 27, that they moved every day along their pasture where they also kept a couple of cows. They were moved by one person using a dolly inserted under the coop and another person lifting the side with the handles. A Salatin coop is a type of low lying rectangular bottomless coop. They can be scaled to various sizes making them a popular mobile chicken coop option. On their farm, Jack and Julie own dogs to keep the birds safe from predators trying to dig under the coops. This became one of our first criteria for improvement; how can we design a mobile chicken coop that will keep the birds safe.



Figure 27: Jack Rawson's Salatin Coop

The second interview we had was with Pam Raymond and her husband at their farm in



## Designing a Mobile Chicken Coop

Hatfield, MA at the suggestion of Jack Kittredge. Pam had a very different set up than Jack. She had a fully enclosed mobile chicken coop that the chickens only stayed in at night and during the day they were let out into a large mobile pen. This pen is moved every four days and the smaller coop is moved every day to a new corner of the pen (See Figure 28). The use of a fully enclosed coop in a mobile pen was Pam's solution to protect the birds against predation. This opened up more ideas about measures against predation.



Figure 28: Pam Raymond's fully enclosed coop in a movable pen

Image courtesy of Pam Raymond

Pam's husband also had one very important idea he wanted us to look into. He had heard of a way to make a retractable wheel system so that when the coop was not being moved it could lie flush with the ground. This wheel system would be very useful to both open bottom and fully enclosed mobile chicken coops. This led to more brainstorming about different possible systems for moving the coops.

The third interview we had, also at the suggestion of Jack Kittredge, was with Jassy Bracko and her husband at their home in Hubbardston, MA at High Meadow Farm. This interview was different from the others due to the fact that Jassy had fit farming to her lifestyle, not the other way around. Jassy was the only hobbyist we interviewed while the other farmers we interviewed were relying on the animals they raised to pay for themselves and supply food them. Jassy and her husband were in the process of thinking of a new coop design to build for next year and had many different suggestions for our own designs. One suggestion was having one side of our designs be completely protected so that in case of harsh weather the birds can stay safe and dry. Another suggestion was to have the roof retract instead of putting normal doors on the coops to increase accessibility to the birds. A picture of one of their mobile chicken coops can be seen

## Designing a Mobile Chicken Coop

in Figure 29.



Figure 29: One of Jassy Bracko's Mobile Coops

### 3.2 Develop Designs Based on Preliminary Research and Interviews

Our preliminary research and interviews left us with different parameters on which to focus our designs. These parameters were: weight, cost, mobility, protection, and materials. Originally we were planning on making upwards of five different mobile chicken coop designs. However, due to the time constraint of the project and the number of overlapping similarities we saw in our background research between mobile chicken coops already on the market, we decided to each make one original design. Each design had a basic function predetermined so that the three final designs would be different. This resulted in three designs that gave us a number of options and ideas for what makes a good mobile chicken coop by the end of our project. The three basic designs that were expanded upon were a hoop coop, a hoop coop hybrid, and a fully enclosed coop.



## Designing a Mobile Chicken Coop

The design process started with just sketching out each design on pieces of paper (See Figure 30, Figure 31, and Figure 32). As different aspects were selected and pursued, the designs started to become more precise and were drawn to scale using graph paper. Once we completed satisfactory, to scale, hand drawn designs, we used a tool called Google SketchUp to make three dimensional computer drawings of the different coops. This tool allowed us to add materials, textures, and dimensions to the design ideas and helped start the planning process for building the prototypes.

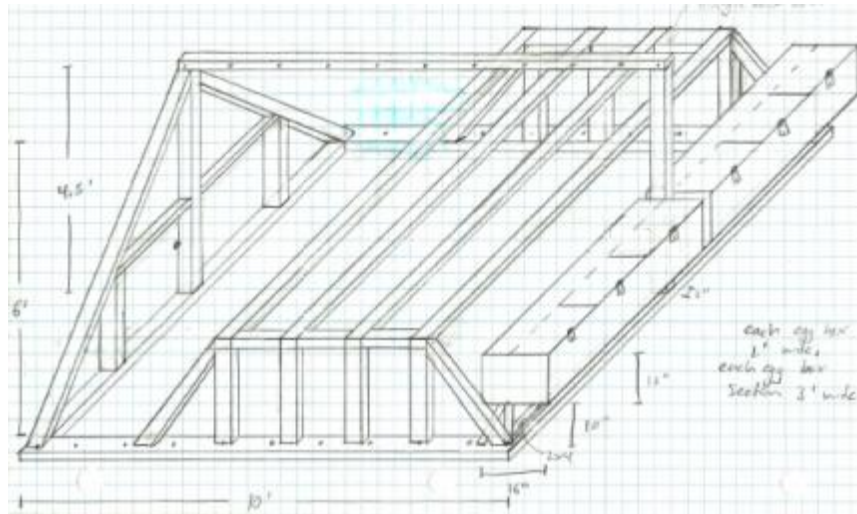

Figure 30: Hoop Coop Preliminary Drawing

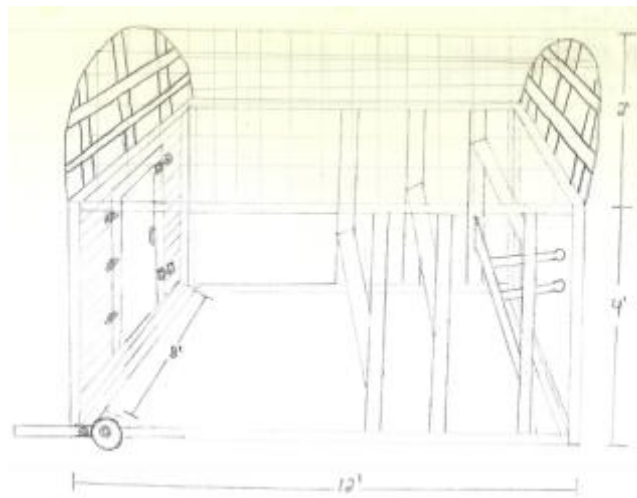

Figure 31: Hybrid Hoop Coop Preliminary Drawing

## Designing a Mobile Chicken Coop

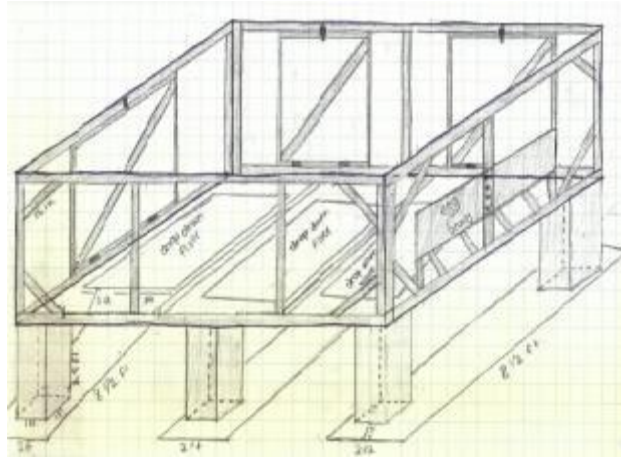

Figure 32: Fully Enclosed Coop Preliminary Drawing

### 3.3 Build Prototypes

We built scaled down prototypes of two of the designs in order to gain a better understanding of how a full sized mobile chicken coop would be constructed. The fully enclosed coop and hoop coop hybrid were built 1/4 scale. These models were built in order to discover any design flaws we had or things that would benefit from being changed. The flaws that were found and the things to change in each design can be found in depth in the findings chapter (Page 9).

In order to be able to build these prototypes, we had to decide upon the materials we were going to use and how we were going to build them. Each prototype was built over B term break so that they would be ready in time for the NOFA Winter Conference we attended in January. We wanted to have physical representations of our designs to help us get more feedback from the conference attendees.

### 3.4 Distribute Information and Design Ideas

On January 11, 2014, we attended the NOFA Winter Conference at Worcester State University where organic farmers throughout the Northeast came together to attend workshops, discover new exhibits and sustainable products, and also listen to lectures performed by different speakers. Our group shared a table with the other groups in WPI's Center for Sustainable Food Systems and presented our ideas, designs, and small scale prototypes. We answered all questions

## Designing a Mobile Chicken Coop

to the best of our ability and happily received the feedback and suggestions offered by the attendees. While at the Conference, we passed out the brochure below that we had made to describe our design ideas with scale drawings, more detailed information about key elements in the designs, and other useful information that organic farmers who were interested in building their own coops may find useful. We also included a short bio about the project and contact information on the brochures for those wanting to know more about our project and blueprint designs.

This brochure contains three different mobile chicken coop designs from a WPI project group from the Center of Sustainable Food Systems. This is part of their Interdisciplinary Qualifying Project that every junior at Worcester Polytechnic Institute has to complete prior to graduation. These projects are generally unrelated to the students' majors and are focused on positively impacting the community. The goals of this project are to create multiple designs of mobile chicken coops that are suitable for different types of birds, easily portable, and offer a safe environment for the chickens.



-Keegan Cole is a Biomedical Engineering major and a member of WPI's Men's Varsity Crew Team. This project interested him because his landlord owns chickens and he wanted to learn about raising them.



-Lindsey DeLuca is an Aerospace Engineering major and Engineering Ambassador for WPI to help kids develop a passion for engineering. This project interested her because she wanted to impact both people and animals.



-Kimberly Zielinski is a Mechanical Engineering major with a concentration in Biomechanics and Physics minor. This project interested her because her grandparents were farmers.

### Minimum Space Requirements for Poultry

Type of Poultry Bird	Sq Ft: Inside Coop	Sq Ft: Outside in a Run
Bantam	1	4
Chickens	1.5-2	8
Layer Hens	2	10
Large Chickens	1	4
Quail	5	25
Pheasants	3	15
Ducks	6	18
Geese		

### Number of Chickens per Feeder

	8-foot Troughs	Range Feeders	Tube Feeders
Layers	50	50	15
Broilers	66	66	33

Recommendations from North & Bell's Commercial Chicken Production Manual.

\*It is important to have enough space per bird to keep your flock healthy and happy.

## Improving Mobile Chicken Coops for Organic Farmers





Keegan Cole  
Lindsey DeLuca  
Kimberly Zielinski

A WPI and NOFA Collaboration

NOFA Mass. Winter Conference  
January 11, 2014

If you want to learn more or have any ideas/suggestions for us, please email us at [chickentoriarip@wpi.edu](mailto:chickentoriarip@wpi.edu).

## Designing a Mobile Chicken Coop

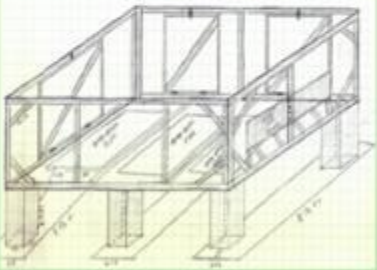
Retractable Wheel System	Handles	Our Designs
	<p>The handles on a chicken tractor greatly affect how easily a coop is maneuvered. Originally we had started with a two handle design, but since our designs have exceeded a person's arm span, we needed to use a different handle. On some of our designs we have a single handle located at the top center of the coop. This option makes turning very easy and solves the arm span issue.</p>	
<p>The retractable wheel system was designed to help with the mobility of chicken tractors while still allowing for the coop to be as flat as possible to the ground when stationary. This system consists of two 20" 2"x4" pieces of wood, a 6" solid rubber tire, one 1/2" bolt with two washers, one lock washer, and a nut, one 1/4" bolt with two washers and two nuts, and one corner brace. When the outer piece of wood is horizontal, the wheel is raised above the base of the coop allowing the base to lie as flush with the ground as possible. When the outer piece of wood is pulled up, the wheel is rotated down and in that position it is extended past the base of the coop, therefore lifting up the coop a couple of inches. The corner brace is used to keep the wheel locked in position when moving the coop so the wheel cannot kick out and drop the coop down.</p>	<h3>Resisting Rot</h3>	
	<p>One of the most difficult problems we are working on solving is how to extend the life of mobile chicken coops for organic farmers. Pressure treated wood cannot be used in an organic setting due to the chemicals in it but untreated wood rots quickly and needs maintenance often. One possible solution to extend the life of the wood is to treat it with oil. Mineral oil can work along with linseed oil. But mineral oil is not a natural option. Linseed oil, however, is the oil from flaxseeds and is natural and safe for use. Other natural oils may also work but we are still in the research stage for this solution.</p>	
		<p>These are the three full mobile coop designs we have been working on. The first is a hoop coop, the second is a hybrid hoop coop, and the third is a fully enclosed coop for a movable pen.</p>

Although the table our group was at was located a bit out of the way, we had some interesting conversations. One man talked about how the mayor in Boston is for having chickens in the city. Another man informed us that the reason chickens are not allowed in Worcester is not because there is a law against owning chickens, but a law against owning unregistered animals and currently there is no protocol to register a chicken. In addition to these conversations, we got some feedback about the two prototypes we had on display.

In addition to attending the NOFA Winter Conference, an article was written in the hopes of being published in the NOFA newsletter, *The Natural Farmer*. This would allow for many organic farmers to learn about this project and the problems we investigated and worked on improving. See the Executive Summary for the article.



### 4. Findings

The goal of this project was to create three designs and prototypes of a mobile chicken coop. This was done through background research and interviews with local organic farmers in which we found ample information regarding organic chicken farming. This chapter includes our findings. First we describe the attitudes of an organic farmer and how their opinions concerning common farming practices helped to shape our own design ideas. Next we consider the needs of our audience, NOFA farmers, and explain how their needs affected our design process. We also analyze the structure of a mobile chicken coop and chronicle the influence that these aspects had over our blueprints and ideas. Lastly, we outline what we learned through the building and design process concerning the optimum tools and materials used.

#### 4.1 Analyses of Organic Standards and Their Effect on Farming

In order to work with organic farmers and create favorable designs based on their interests, our group first had to understand their ideals and opinions concerning farming practices. An article from the University of Wisconsin performed a survey in which twenty-five organic and conventional farmers were personally interviewed, using qualitative and quantitative survey methods, in order to discover their attitudes towards the environment and sustainability (Sullivan, Erickson, Young, 1997). Both conventional and organic farmers have awareness when it comes to the personal impact their farming methods have on the environment. However, it was discovered that although both classes of farmers possess a sense of economic awareness, organic farmers are more likely to shape their farming practices in order to lessen their negative impacts on the environment. In this survey, many organic farmers expressed concern over agricultural chemical pollution caused by conventional farming tactics. They also indicated their worry about pesticide residues on food, air pollution, pesticide drift, and their lack of control over the problem, while none of the conventional farmers included these concerns in their survey responses.

The concerns and worries expressed by these farmers, as documented by the University of



Figure 33: Chicken Feces as Fertilizer

## Designing a Mobile Chicken Coop

Wisconsin study, affect the lifestyle and techniques that these farmers employ, thus also shaping our own designs and ideas. These concerns also helped to produce common organic farming standards. One aspect of these standards prohibit the use of any synthetic fertilizers or pesticides, thus causing organic farmers to search for other techniques in order to reduce the presence of pests, while also resulting in the production of healthy crops. After some research, our group found that animal feces serve as an effective natural fertilizer. We also learned through an interview with a local farmer, Pam Raymond, that chicken feces does not need to be aged in order to be put in compost and used as fertilizer, making chicken feces a very cheap and desirable form of fertilization. As for pests, we learned through several interviews that a chicken's pecking behavior rids the land of pests without the need for chemical insecticides.

These considerations lead us to a major conclusion concerning our designs. We inferred that if chickens were to be left in a coop all day, then the coop must have an open floor plan, since it would allow the flock to peck and fertilize the ground. So, two out of the three designs we created utilized the idea of an open floor plan. However, after an interview with Pam Raymond, we learned about mobile pens which allow chickens to graze during the day while protecting them from potential predators. Inside this pen would be a mobile coop that the chickens would stay in overnight before being let out in the morning to peck and fertilize the land. This lead us to design a coop with a closed bottom since the ground would still be able to be tended by the chickens during the day when they free ranged within the confines of the mobile pen. Thus, our last of the three designs utilized the idea of a closed bottom coop within a mobile pen for extra protection from predators during the night and an allowance of the chickens to freely graze during the day.

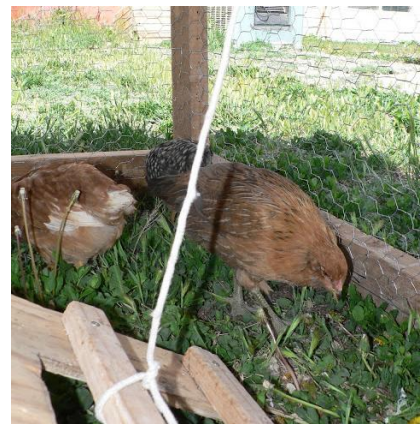

Figure 34: Open Floor Plan

Source:

<http://www.blessthismessplease.com/2012/05/dyi-chicken-coup>

Another organic standard dictates the type of feed animals are allowed to consume in order to still be considered organic. This results in more expensive feed, which puts a burden on the organic farmers. According to our sponsors Jack Kittredge and Julie Rawson, grass can make up to twenty five percent of an organic animal's diet. In order to save money for our audience,

## Designing a Mobile Chicken Coop

we made easy access to grass a major proponent of our designs, thus further emphasizing an open bottom or a movable pen that permits grazing during the day.

### 4.2 Needs of NOFA Farmers

Through our interviews with our sponsors, our team discovered that our designs must serve an array of different types of farmers. The three main classes include full-time farmers, self-sufficient farmers and hobbyists. Because of these different classes of farmers, our group decided to create multiple designs that keep the interests of our entire audience in mind. We'll describe how these classes of farmers affect the key parameters of our design, such as weight, size and structure.

The first key parameter that varies throughout the different classes of farmers is weight. Full-time farmers tend to hire workers in order to have extra hands on the farm.

Because of this, we can be less concerned about the weight of the coop and its ease of mobility since more people will be able to help move it. Self-sufficient farmers and hobbyists, on the other hand, do not have a surplus of laborers, but instead are individuals or small families. Therefore, we must greatly limit the weight of the coop, building it so that one person is capable of lifting and moving it.

The size of the chicken coop also varies from farmer to farmer. The finances and income of full-time farmers depend on the output of their crops and livestock, therefore, they are more likely to own more animals in order to generate more of a profit. Because of this, our designs must be able to hold a large number of chickens. Self-sufficient farmers, like hobbyists, are similar when it comes to this key parameter, only needing a few chickens, which require a much smaller coop than full-time farmers. The various sizes of chicken coops require our designs to be versatile, and appropriate for different scales.



Figure 35 Full-time Farm

<http://www.keystoneedge.com/features/spinfarming0723.aspx>

## Designing a Mobile Chicken Coop

The last major key parameter that varies across the different classes of farmers is the structure of the coop. Unlike full-time farmers and even self-sufficient farmers, hobbyists do not wish for their schedules to become affected by their chicken farming. So a coop that has to be moved more than once a day or a coop inside a movable pen that has to be closed at night is not desirable to them. This greatly affects the structure of the coop, since it cannot be inside a movable pen and, therefore, needs to have many layers of protection against predators. Other than the instance mentioned, the structure of the coop does not vary across the different types of farmers.

### 4.3 Analyses Regarding the Structure of a Mobile Chicken Coop

The findings below reveal the components that must be considered during the design process of a mobile chicken coop and its structure as well as information regarding flocks and the field of organic chicken farming itself.

#### **Finding 1: Ventilation is necessary in any chicken coop design and without it the health of the chickens are at risk.**

Chickens can handle a wide variety of temperatures, although their bodies perform best below seventy five degrees. The one element that chickens have trouble handling is moisture, which ventilation can easily remove. Chickens generate immense supplies of water vapor through their breathing and also through their feces, which contains considerable amounts of water. This water and vapor that chickens produce commonly create a damp and humid atmosphere within the coop that can be harmful towards the flocks. This large amount of humidity can lead to respiratory



Figure 36 Coop with Ventilation



## Designing a Mobile Chicken Coop

problems in the birds as well as frostbite if the weather is colder. Ventilation is necessary in coops so that the warm air may rise and escape out of the coop, being replaced by cooler and drier air.

In our interview with Pam Raymond and her husband, our group discovered that ventilation can also decrease the amount of heat inside a coop. The body of a chicken can withstand freezing and relatively hot weather; however, once the chickens begin to experience temperatures above ninety degrees, health problems ensue. The flocks begin to be at risk for heat stress, their egg laying capabilities drastically decrease and they might even die from overheating. According to Pam, a coop runs the risk of baking the flock if proper ventilation is not considered and installed. Since heat rises, it is best to put ventilation above the roosts so that the hot air may escape and the coop will not be any hotter than the outside atmosphere. However, our chicken tractor designs are not intended for winter use and will only be utilized in warmer weather. The ideal design for this situation is to implement wire netting instead of solid walls, thus ventilation along the ceiling will not be necessary since wire fencing around the coop will ensure that the birds will get proper ventilation and will not develop health problems due to the poor climate.

### **Finding 2: Both aerial and land predators serve as an immense threat to the flock, therefore, adequate protection is necessary in the mobile chicken coop design.**

Through our interviews with local organic farmers, we discovered that aerial and land animals put the lives of the flock at great risk. Included is a figure that lists common predators, what part of the flock they eat, clues they leave behind, the time when they are most dangerous and any recommended defense against them.

# Designing a Mobile Chicken Coop

Predator	Eats	Clues	Most Dangerous	Recommended Defense
Human	Adults, Chicks, Eggs	Many birds missing with no trace. Birds missing from secure areas (i.e. open gates, etc.)	24 Hours	Padlocks, motion sensing lights, guard dog, basic burglar-proofing, etc.
Dog	Adults, Chicks	Many birds mauled, few/no signs of birds actually eaten.	24 hours	Exclusion Fencing
Cat	Chicks, Rarely Adults	Chicks missing, adults may have feathers missing, but rarely killed except by aggressive/feral cats. Birds rarely eaten by house pets. Strays may consume chicks.	Night	Exclusion Fencing
Mink/Weasel	Adults, Chicks, Eggs	Many birds killed by small bites on body. Carcasses may be piled, some heads may be eaten.	Night	Exclusion fencing (tight weave)
Raccoon	Adults, Chicks, Eggs	Several birds killed. Heads and crops may be eaten. Live birds with missing limbs as coons may reach through wire to pull legs.	Night	Exclusion fencing (tight weave), with overhead cover (roof or wire netting). Raccoons can easily scale fences.
Hawks/Owls	Adults, Chicks	One bird killed/missing. Head eaten, birds huddled and hiding under overhead cover.	24 hours	Exclusion fencing (tight weave), with overhead cover (wire or nylon netting)
Ravens	Chicks, Eggs	Chicks missing, eggs broken and consumed.	Day	Exclusion fencing (tight weave), with overhead cover (wire or nylon netting). Note: Ravens have been known to open simple latches!
Opossum	Adults, Chicks, Eggs	One or two birds killed. Only abdomen eaten.	Night	Exclusion fencing (tight weave)
Fox/Coyote	Adults, Chicks	One to many birds missing or killed. Often piles of feathers left behind. Birds not taken will have broken necks and/or feathers missing from neck.	Night/early AM	Exclusion fencing (tight weave). Coyotes are notorious for digging under fences and can chew through light gauge wire. Use 18 gauge or heavier for fencing.

Figure 37 Predator List

Source: <http://backyardchickens.com>

## Designing a Mobile Chicken Coop

Because of these and other predators, the mobile chicken coop must be built with protection as one of its main focuses. Many different aspects of the coop can be adjusted to ensure optimum protection against any threat. Predators can come from the air, dig under the coop itself and even rip the siding off; therefore, our group had to plan to protect the flock from all directions and angles.

One way a predator can attack and kill an entire flock is by ripping the siding off, or even unhinging latches and gaining access to the entire inside of the coop, leaving the birds extremely vulnerable and unprotected.

Our group learned that for our mobile chicken coop, we should use hardware cloth instead of chicken wire for the ultimate defense against animal threats, since we are not using solid walls to surround the coop. Through trial and error, one farmer learned that chicken wire can be



Figure 38 Coop with Hardware Cloth

<http://www.nwedible.com/2011/06/chicken-coop-is-donenough>

easily pried away from the structure, especially by raccoons, allowing the

hunter to easily gain access to the birds. However, the budget imposed for this project makes it difficult to surround the entire mobile coop with hardware cloth, since it can be very expensive. Therefore, one farmer suggested that we use hardware cloth up to the height of a few inches above the chickens' head and then use chicken wiring for the rest of the coop. This way the predators cannot reach through the chicken wire and rip parts of the chickens' bodies off since it will be too high up for the predator to reach in. However, there has been an instance on farms where raccoons and other pests have climbed up the coop and have still tried to pry the chicken wire off, so hardware cloth throughout the coop is a better investment to protect a flock.

## Designing a Mobile Chicken Coop

When building a mobile chicken coop, one must also be concerned about the latches on the doors. As stated in the figure above, ravens as well as raccoons have been known to unlock simple latches. Farmers that we interviewed recommended double snaps as a good means of fastening coops and protecting the flock.

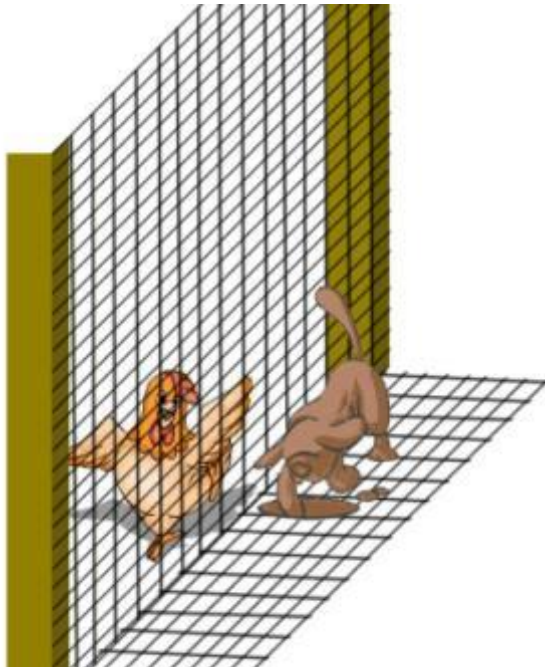

Figure 39 Protection from Digging

[www.vetstreet.com/our-pet-experts](http://www.vetstreet.com/our-pet-experts)

Although hardware cloth and complex latching may protect the coop from all sides, predators can still dig underneath the coop. Some farmers solved this problem by acquiring guard dogs which scared the predators away. For those farmers that do not have guard pets, the most ideal solution would be to surround the coop with chicken wire and use step-in stakes to secure the netting into the ground. Predators will try to dig on top of the chicken wire, but will be unable to go anywhere due to the wiring surrounding the ground around the coop. These predators are also not smart enough to step off of the chicken wire and dig under the ground that is not covered by the netting, thus sufficiently keeping the flock safe from any

digging predators.

So far, we have considered threats caused by land creatures, but now we must also concern ourselves with aerial threats. Many farmers get rid of aerial predators permanently by hunting and killing them. However, many species of birds, hawks and owls included, are protected under the Migratory Bird Treaty Act established in 1918, which makes it illegal to kill many bird breeds unless given permission by the federal government. Besides, once one bird of prey is killed off, it is more than likely another aerial threat will take its place. Proper roofing can adequately protect a flock from aerial threats without breaking any laws and can serve as a strong defense. A roof can either be made of solid material or wired netting.

For flat roofing, it is common to have it consist mostly of a flat metal or plastic panel to protect the birds from predators, rain, and harsh summer sun. Some farmers choose to leave part



## Designing a Mobile Chicken Coop

of the roof as wired netting where the birds cannot be reached for ventilation purposes. Another option for roofing is a hoop structure. These hoop roofs consist of a wire netting base with sheet plastic stretched over it. The wire netting and plastic provide a barrier between the chickens and possible aerial predators.

**Finding 3: Movement is a very important component of a mobile chicken coop and must be considered during the design process.**



Figure 40 Dolly Movement System

[www.mofga.org/Publications/MaineOrganicFarmerGardener](http://www.mofga.org/Publications/MaineOrganicFarmerGardener)

individual backyard homesteaders that may not have an extra hand to help him or her move the coop.

Farmers use many different methods when moving a chicken coop. One farmer we interviewed would place a dolly under one side of the coop and there would be handles to raise the other side. One person would lift the coop using the handles, while the other person would push the dolly. Although this is an effective way to move the coop, it takes two or more people to perform this task. Our group's design is targeted for

## Designing a Mobile Chicken Coop

However, there are multiple design ideas that will allow for one farmer to move a coop. One design idea we considered was presented to us by Pam Raymond. The mobile coop has two wheels on one side. Attached to each wheel structure would be a thick piece of plywood. In order to move the coop, one would have to push the plywood towards the ground, thus lifting the coop inches off the ground and allowing for easier movement of the coop. the plywood would also lock in place once pushed down so the continuous force does not need to be applied. Although this design would allow for easy movement of the coop, it is not very feasible to build and, therefore, might not be the best approach for farmers that have little experience in construction.

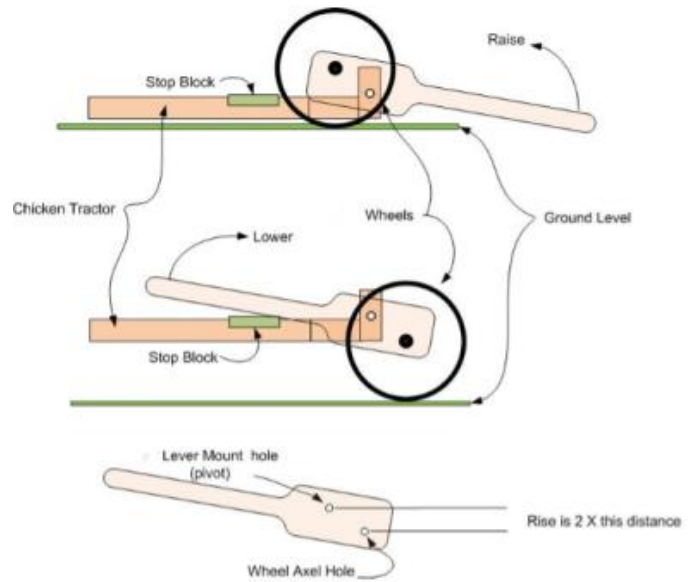

Figure 41 Two Wheel System

[http://www.avianaquamiser.com/posts/Wheel\\_lift](http://www.avianaquamiser.com/posts/Wheel_lift)

The most simple design idea our group developed would be to have four wheels



Figure 42 Four Wheel System

<http://www.lancasterchickencoops.com/quaker-q48-coop.php>

on each corner of the coop. Since the wheels would lift the coop a few inches off of the ground, we would have to include a retractable siding between the bottom of the coop and the ground to prevent predators from sneaking underneath the little space that the tires provide. The tires would be connected to the coop through an axle system, although axles tend to bend and become misshapen. To remedy this, our group must either limit the movement of the coop or



## Designing a Mobile Chicken Coop

change the axles periodically in order to ensure an optimal coop design. It was also brought to our attention that four tires will be hard to turn and maneuver and are at risk of tipping. For farmers on particularly flat farmland that do not plan on turning the coop too often, the four wheel structure would be most advantageous.

Although the number of tires and the manner they are attached to the coop are extremely important, the type of tires we use are of equal importance since farmers live on different terrains, as discussed in the Background Chapter. Typically, for lands with more elevation and bumps, tires should have puncture resistance and stone ejecting tread as well as biting edges to help the coop claw up and over the hills. For flatter land, there are not as many constraints on which wheels to use, since there are not many obstacles to impede movement, therefore, any wheels that can support the chicken coop can work. It was recommended by local farmers to use pneumatic tires instead of rubber tires since they can better handle rough terrain with an ideal thickness of three to four inches.

### **Finding 4: The inside structure of the mobile chicken coop is vital to the happiness and overall health of the poultry.**



**Figure 43 Egg Boxes with Privacy**

<http://www.the-chicken-chick.com>

As discussed in the background chapter, there are many different types of poultry that an organic farmer can raise, one being layers, which, unsurprisingly, provide eggs for the homesteaders. When laying eggs, chickens prefer large amounts of privacy, so it is crucial that a farmer provides an egg nest for the poultry that are blocked

off or covered as much as possible. The more

privacy, the happier the hens will be and the more eggs they will lay. Because of this need for privacy, egg crates attached to a coop are not ideal for layers, instead they prefer boxes made out of a solid material with small openings that they can fit inside of and proceed to lay. An easy

## Designing a Mobile Chicken Coop

way to provide enough covering is to hang fabric across the openings to create a make-shift curtain. In the coop, there should be one nest for every three birds.

Layers not only need nest boxes, they also need roosts, like most breeds, since they instinctively prefer to sleep at higher points. These roosts must be higher than the nesting boxes by at least two inches, so the chickens are more apt to sleep on the roosts as opposed to inside the nesting boxes where they will generate a huge mess. Roosts must also be at least eighteen inches from the roof of the coop and a foot from the floor in order to provide adequate room for the birds. Staggering the roosts will also provide more room for the birds in the coop; however, it will also add extra weight, which must be considered when creating the design. Wider roosts are also more preferable for the flock since it allows them to sit on the roost and bury their feet as opposed to grabbing it with their claws, which protects against frostbite as well.

Inside the coop, water and feed must be made available for the chickens so that they do not starve or get dehydrated. Feeders and water should be able to be raised and lowered, so that they can always be at a height parallel to the backs of the chickens. This prevents food from being wasted, since they will be less apt to fling the feed everywhere. Round feeders are also preferable to trough feeders, since chickens are more likely to fling the feed and waste it if it were put into a trough. Trough feeders also cause farmers to develop a major problem with mice. However, round feeders tend to take up more space than troughs, although they do save farmers at least thirty dollars a month on wasted feed.



Figure 44 Round Feeder

<http://www.food-skills-for-self-sufficiency.com/raising-chickens>

### 4.4 Optimum Materials and Tools

While building our prototypes and through interviews with local farmers, we learned about the optimum materials and tools that need to be used in order to create a favorable chicken coop. Although access to a vast supply of tools would be ideal when building a chicken coop, we will include a list of the minimum materials and tools that need to be used in order to create a successful project.

Each design featured in this report requires different types and amounts of materials. In the appendix, we have included materials lists for all three blueprints. Now, we will describe the reasoning behind why we used the materials we used. Organic farming standards dictate that we may not use any kind of pressure treated wood, or any materials that may leak harmful chemicals into the environment. This greatly limited our options. After our interview with our sponsors Jack and Julie, we narrowed down our valid list of materials to aluminum piping, PVC piping and untreated wood. In an interview with Pam Raymond, we were warned of the hazards that a coop solely made out of PVC piping may produce. Her professional opinion stated that PVC piping would be too light to stand against the heavy winds and not sturdy enough to protect

against large sized predators. We suggested weighing the PVC down with sand, but this

would only make the coop heavier and harder to move. After getting opinions from local farmers, we met as a group and listed the pros and cons of each material, which can be found in Appendix B, and ultimately deciding untreated wood would be the best material in which to build a chicken coop. To protect from rotting, a local farmer, Jassy, and her husband suggested coating the wood in linseed oil. To learn more about the materials and our thought process behind them, refer to the background chapter and appendix.



Figure 45 Circular Saw

<http://www.dewalt.com/tool-categories/Saws.aspx>

## Designing a Mobile Chicken Coop

After building two prototypes, our group learned much about the types of tools that go



Figure 46 Front Door of Prototype

into constructing a mobile chicken coop. The main tools used include, a drill, a hammer, and various types of saws. In order to cut wood into the adequate sizes, we used a circular saw, though it can also easily be done with a hand saw if a circular saw is not readily available. For the prototype of a chicken coop in a movable pen, we also had to cut out sections of the floor in order to make it drop down. To do this, first we had to drill a hole into two diagonal corners and use a handsaw to cut out the sections. However, this left

little drill holes in the drop down part of the flooring, which is not aesthetically pleasing, but

does not greatly affect the design. We also had to cut some ends of the wood into specific angles. To do this, we used a circular saw, which can be set to a certain angle, making cutting the wood much more accurate and easy. While cutting the wood, it is also very important to wear face masks to ensure that one does not inhale the dust created by the wood. Apart from the various saws used, we also greatly utilized drills in order to screw in various parts of the coop. We screwed certain sections, such as when connecting the ground supports to the flooring in the movable pen prototype, in order to optimize the sturdiness of the coop. For the parts where screws were not used, we used a hammer and nails to connect the pieces of wood. On the movable pen coop, we fashioned the doors using two different styles in order to test which one would serve its purpose and keep its shape the best. As seen by the pictures, one door used a metal corner joint and screws in order to strengthen it, while the other door used diagonal wood supports. After some testing, it was unanimous that the metal corner joints and small screws proved to be more sturdy. Many of our supports were nailed so that the wood would not split, using two nails at each joint instead of one in order to improve sturdiness. However, there can be artistic freedom when constructing the frame of the coop. It is up to the builder to decide whether to use screw or nails, with screw providing more sturdiness, but risking splitting the wood.

## Designing a Mobile Chicken Coop

A big enough workspace is also necessary when building the coop. The prototypes were made in a basement and a garage, however, if building a full sized model, one must ensure they have enough room. If building indoors, one must also be able to carry the coop outside as well as be able to fit it through doorways. Storage must also be considered when building the coop. One local farmer made their coop easy to disassemble and store away in their barn during the winter month, while another farmer moved the coop on the edges of their farm, where it can be out of the way, and covered it in tarp. The designs we created will most likely be too large to store and are too complicated to disassemble, leaving farmers with the only choice of storing it outside during the winter months.



Figure 47 Side Doors

Overall, the building of the coop was not too complicated, although some knowledge of woodworking would be ideal. Our group mates had limited knowledge concerning the building of a coop, so we sought assistance from family members with tools and skills. Like previously stated, wood is the best material to use due to its sturdiness and ease in which to build with. A hand saw, drill, hammer and face mask are necessary tools when building a coop, however a circular saw and table saw are both handy to have.

### 5. Designs

There is no right answer in the process of design. Design is an open-ended process that cannot just be mathematically solved. Reaching an end result can be unclear because there is no pre-defined path to follow. To design is to creatively envision the nonexistent with the hope of bringing it into reality. Designing has been claimed an art, instead of a science. There are no rules that we must obey when creating art. The design process is to imagine new ways to accomplish certain goals while meeting the constraints of the real world.

One of our first tasks in the design process was to brainstorm ideas and find out the most important criteria of a mobile chicken coop. To organize and relate these criteria to mobile coops, we developed an objectives tree (See Figure 48). This helped the designs obtain a better reasoning of the client's project statement. The client's objectives are branched out in a tree-like manner using hierarchical lists. Each primary objective had a sub-objective that further specified parameters to consider when making a design. The objectives at the top of the tree were the top priorities that were gathered from the client's project statement.



# Designing a Mobile Chicken Coop

Figure 48: Objective Tree

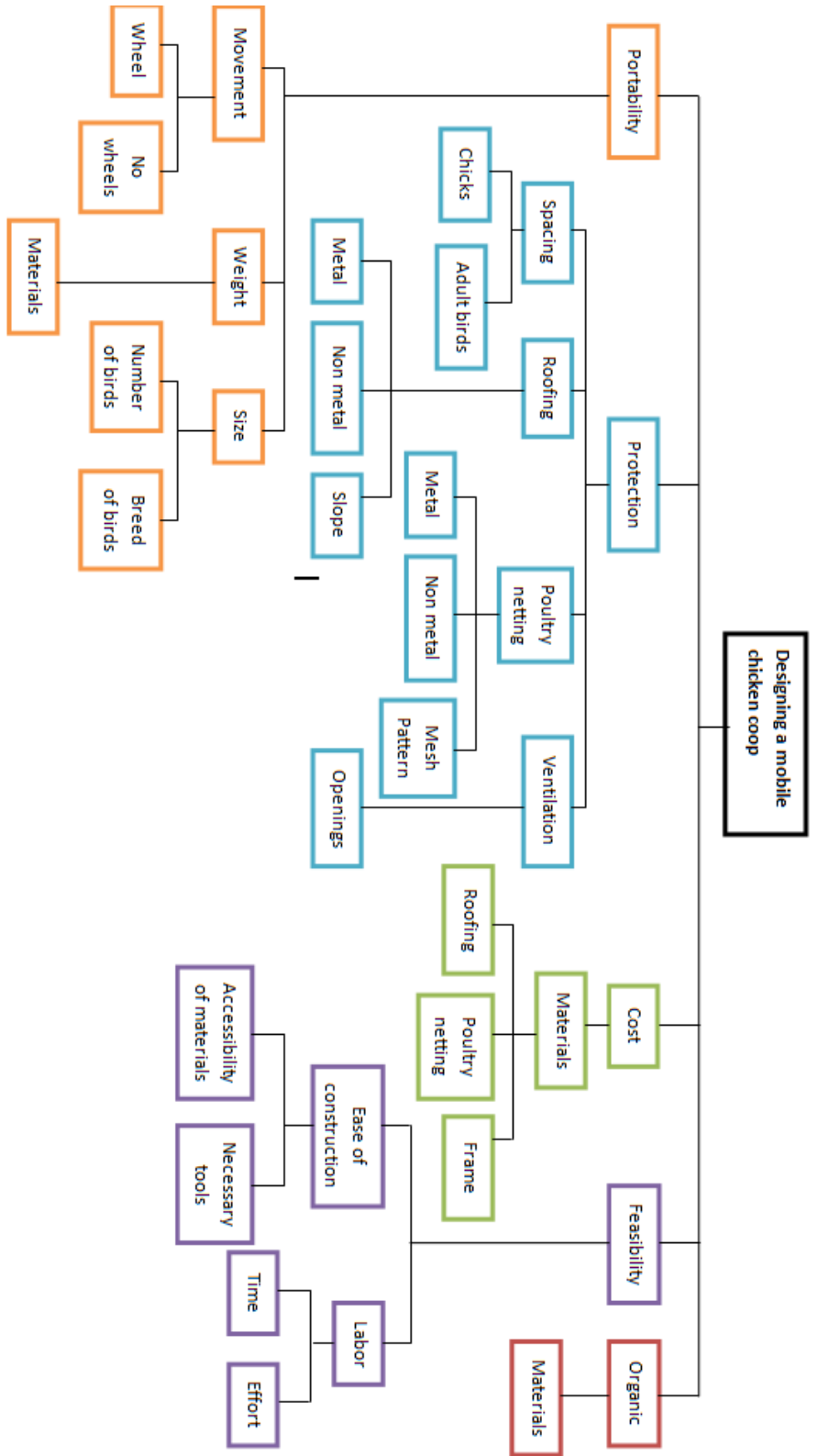

## Designing a Mobile Chicken Coop

Another common method we used is constructing a pairwise comparison chart (PCC) (See Figure 49 and Figure 50). Using a matrix chart, the primary objectives were listed as both rows and columns. We then compared the objectives in pairs to determine which ones were most important to our designs. The parameter that was deemed more important was given the number one while the less important parameter was given the number zero. After comparing all of the parameters, the totals were calculated and the higher the score meant the higher the priority. This helped us establish the order of importance of our key design parameters. The PCC gave us a ranking from highest importance to least importance of organic, protection, portability, cost, and feasibility. Our organic parameter means that the coops must be made of materials that are approved for organic farming use and will not harm any animals or leach chemicals into the soil. The protection parameter refers to creating a safe environment for the chickens to live in. Portability is a desire to make the coop designs as mobile as possible. Cost is a desire to make the designs affordable for all audiences that might be interested in them. Feasibility is a general parameter that accounts for how possible it will be to build a design and to have it work correctly. After we finished these steps in our design process, we moved onto creating our own designs.

**Figure 49: Pairwise Comparison Chart**

<b>GOALS</b>	Portability	Protection	Cost	Feasibility	Organic	<b>SCORE</b>
Portability	x	0	1	1	0	2
Protection	1	x	1	1	0	3
Cost	0	0	x	1	0	1
Feasibility	0	0	0	x	0	0
Organic	1	1	1	1	x	4

Figure 50: Graph of Pairwise Comparison

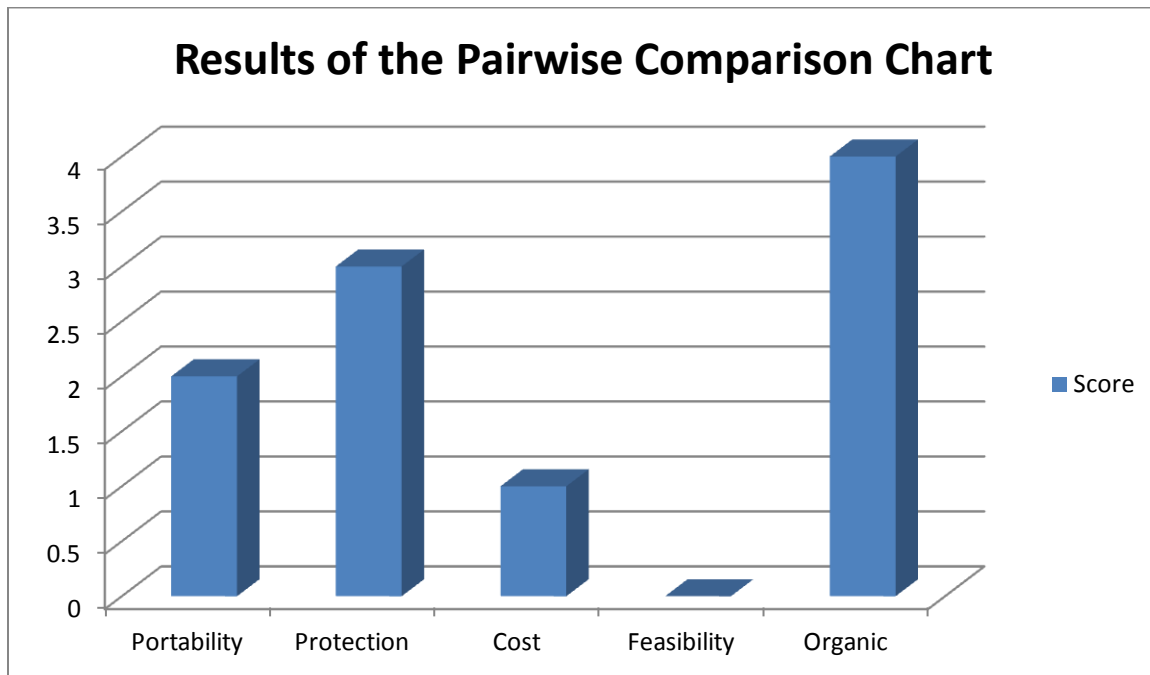

At the conclusion of the design process, we ended up with three different designs: a hoop coop, a hybrid hoop coop, and a fully enclosed coop for a mobile pen. The hoop coop and hybrid hoop coop designs targeted both commercial farmers and hobbyists. These two designs can be easily scaled to fit different needs and sized flocks. The fully enclosed pen for a mobile coop was targeted for experienced small scale farmers. It requires prior knowledge about raising chickens and time to clean it in exchange for providing a safe environment for the birds at night.

Figure 51: Hoop Coop

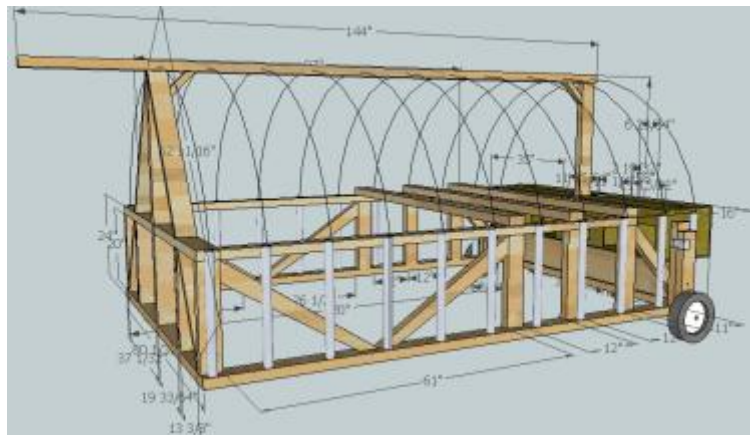

# Designing a Mobile Chicken Coop

Figure 52: Hybrid Hoop Coop

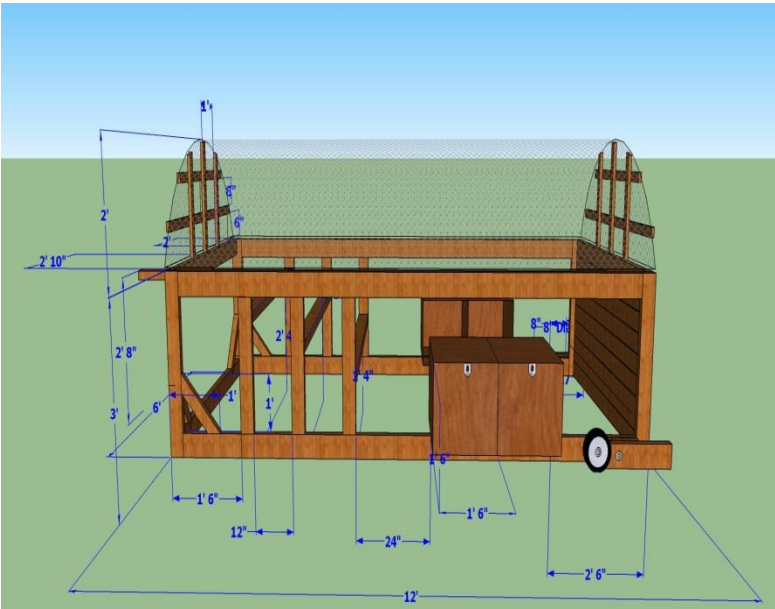
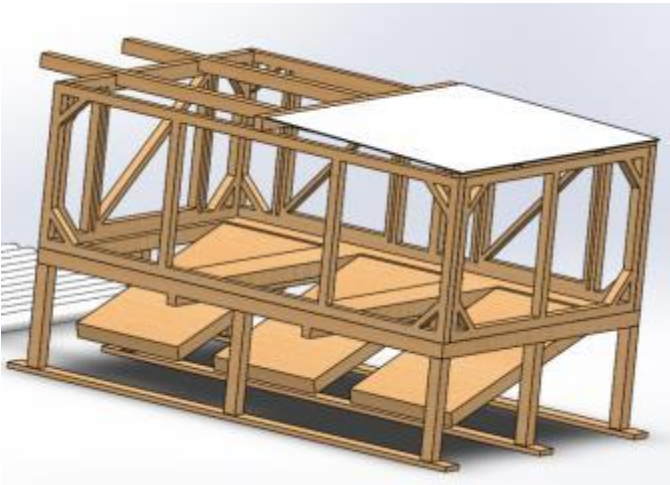

Figure 53: Fully Enclosed Coop



## Designing a Mobile Chicken Coop

### 5.1 Hoop Coop

Hoop coop designs have been around for a while and are readily available for purchase online. These designs allow for easy access to the chickens due to the height of the coop. However, hoop coops are generally restricted to one size due to the cattle panel used to make the hoop (See Figure 54). Cattle panels only come in one size, 16'x50", which is a major limiting factor. These hoops end up only being able to hold a maximum of about eight adult chickens. When making an initial list of parameters for our designs, we decided as a group that we wanted each design to hold as many chickens as possible, while still being relatively light and mobile, to make them viable options for both large and small scale farming which meant that we needed a way to increase the maximum size of the hoop coop.

#### **Design Intent:**

This hoop coop design was meant to find an alternative to the cattle panel which would allow for a much larger coop that the user would have easy access to. Some of the options that were explored were small diameter aluminum piping and PVC piping. Since the design did not require the use of cattle panel and is much larger than ones that are commercially available, the base of the coop and the supporting structures had to change from that of a hoop coop normally available for purchase. The beginning sketches of this coop when it was still going through the planning phase can be seen in Appendix C. These early designs, however, posed problems associated with the mobility of the coop.

#### **Design Parameters:**

A major design parameter was focusing on making the design light weight and easily



Figure 54: Cattle Panel Hoop

Source: <http://www.peakprosperity.com>

movable. As stated before, using cattle panels to build a hoop coop restricts its size and therefore also restricts its weight. These coops tend to be light enough that the user can just drag them to a new position without needing wheels whenever they desire.

By eliminating the use of the cattle panels and increasing the size of the coop, a wheels system

## Designing a Mobile Chicken Coop

was needed in order to assist in the movement of the coop due to the increased weight. To address the mobility design parameter, a retractable wheel system was created (See Figure 55). The computer drawing is dimensioned in inches.

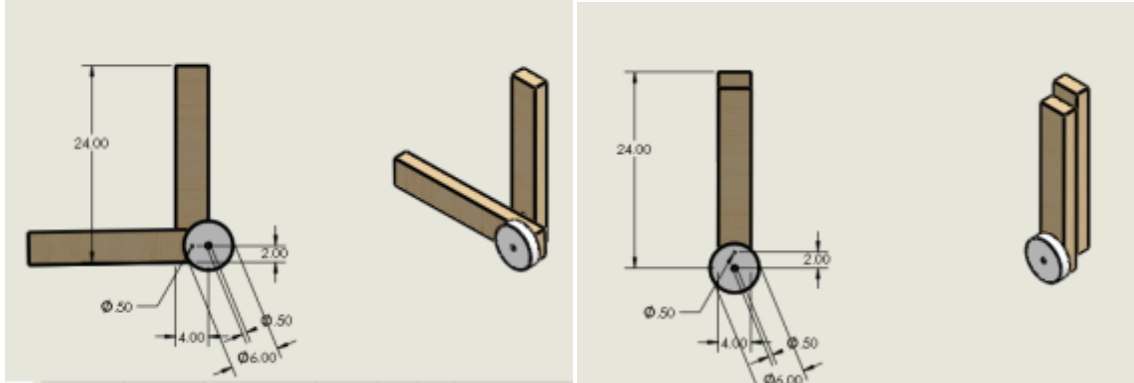

Figure 55: Retractable wheel system

This system utilizes two wheels on the rear of the coop that can be used to raise the coop about 2 inches off the ground when moving it and then allow for the coop to be lowered back down onto the ground when stationary. The wheels are secured in the upright position by metal braces when moving the coop. This system can also be used in different mobile chicken coop designs as a means to increase mobility while still assuring there are no gaps for the birds to get out through or predators to get in through.

Once it was determined that the addition of a wheel system would make moving the coop a much more manageable task, the final design for the hoop coop was drawn up (See Figure 56).



## Designing a Mobile Chicken Coop

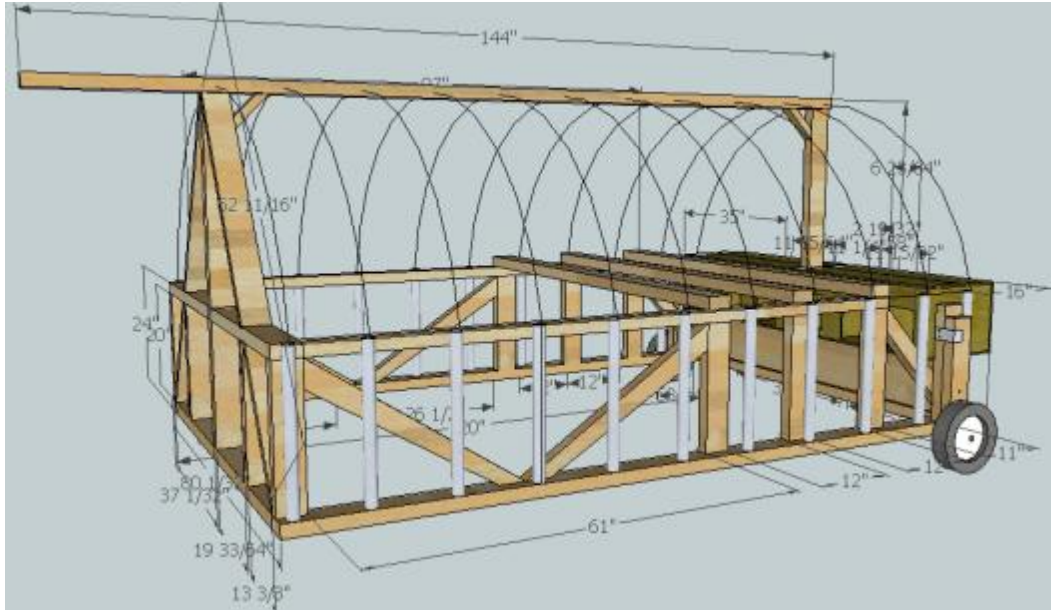

**Figure 56: SketchUp Hoop Coop Full View**

This coop was designed to be 4.5 feet tall with two 18" x 24" access doors on the front (See Figure 57). The length of the coop was 10 feet with poles to act as the ribbing of the hoop at 1 foot intervals. In the rear of the coop there are six 16" x 12" x 12" egg boxes that are accessible from the outside and are located 2 inches below the roosts to assure the birds do not end up sleeping in them. The egg boxes are supported and stabilized from below by a vertical piece of wood and another diagonal piece of wood. The diagonal piece of wood that is supposed to be helping brace the underside of the eggs boxes is missing in these images. It kept getting distorted in the software but should be included when building the model but can be seen in a drawing in Appendix C. The nest boxes are also tied into the central vertical post and the external diagonal brace. Finally, the coop is 6 feet wide with 3 roosts spaced at 1 foot apart that span the entire width of the coop (See Figure 58).

In order to address the protection against predation parameter, this design is meant to have hardware cloth laid over the entire frame. Hardware cloth is stronger than chicken wire and has a smaller mesh to better protect the birds. In addition, greenhouse plastic, or a similar material, should be layered on top of the hardware cloth to protect the chickens from the rain.

Designing a Mobile Chicken Coop

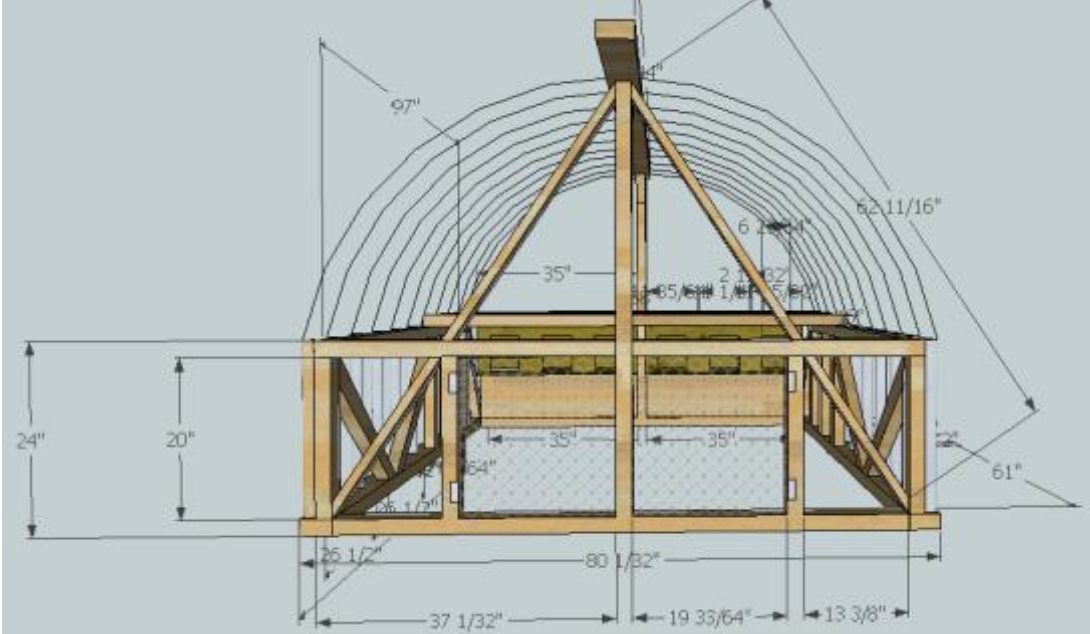

Figure 57: SketchUp Front View

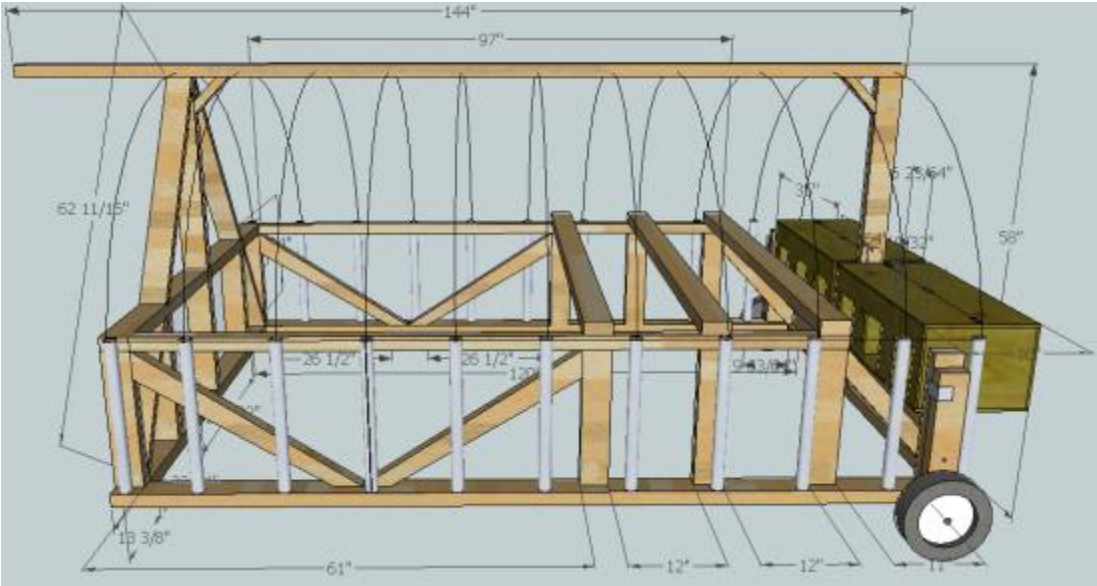
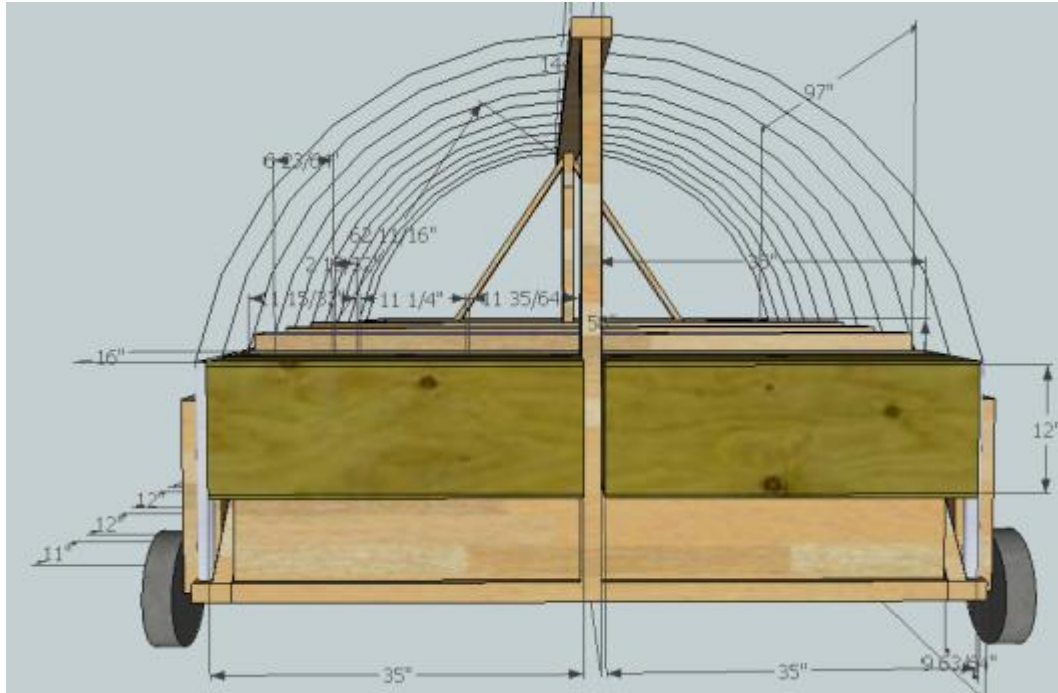

Figure 58: SketchUp Hoop Coop Side View

## Designing a Mobile Chicken Coop



**Figure 59: SketchUp Hoop Coop Rear View**

### **Pros and Cons List:**

Pros	Cons
<ul style="list-style-type: none"> <li>• The height of the coop allows for more birds to be housed within it and easier access</li> </ul>	<ul style="list-style-type: none"> <li>• The height of the coop could make it difficult to maneuver due to lack of sight</li> </ul>
<ul style="list-style-type: none"> <li>• The retractable wheels aid in moving the coop while allowing it to lay flush to the ground when stationary</li> </ul>	<ul style="list-style-type: none"> <li>• The weight of the coop may cause extra stress and wear on the wheels requiring maintenance</li> </ul>
<ul style="list-style-type: none"> <li>• Using aluminum or PVC piping as a substitute for cattle panels allows for a greater maximum size</li> </ul>	<ul style="list-style-type: none"> <li>• It will be much more difficult to secure the individual pipes than it would be to secure one panel</li> </ul>
<ul style="list-style-type: none"> <li>• The single central handle aids in turning the coop</li> </ul>	<ul style="list-style-type: none"> <li>• Having a single handle will concentrate the load the person has to lift in order to move the coop</li> </ul>
<ul style="list-style-type: none"> <li>• The coop is designed to house a large amount of chickens and can be easily scaled down</li> </ul>	<ul style="list-style-type: none"> <li>• The larger coop will increase the weight causing mobility problems</li> </ul>

**Table 1: Pros and Cons for the Hoop Coop**

### **Prototype:**

## Designing a Mobile Chicken Coop

A prototype of this design was made to assess any construction difficulties and possible design changes that might arise. It was made using a hand held revolving saw and a table saw which are both common building tools that many people have access to. This particular prototype was  $\frac{1}{4}$  the proposed size of the design (See Figure 60). Due to its reduction in size, some of the supports shown in the drawings and the SketchUp images were left out due to being unnecessary for the scale and the spaces involved being too small to work with. In addition, the hoop part of the coop was not added onto the prototype due to the poles being too large for the scaled down coop. However, even though the coop was built to  $\frac{1}{4}$  the size of the desired outcome, the wheel system made to address the mobility of the design was built as full scale (See Figure 62 and Figure 61).



**Figure 60: Hoop Coop Model Full View**



## Designing a Mobile Chicken Coop



**Figure 62: Retractable Wheel System 1**      **Figure 61: Retractable Wheel System 2**

### **Materials:**

The materials used to make the prototype were those for a full scale model. Untreated 2x4s made up the base and framework while plywood was used for the egg boxes. In order to increase the lifespan of the wood, it can be coated with linseed oil which is safe and approved for organic farming use. The oil helps prevent rotting and decreases the amount of maintenance needed on the coop. The poles that we had planned on using were 2 inch diameter PVC piping but 1 inch aluminum poles for tents would have worked as well. The PVC was going to be used because we already had it on hand, but the size of the coop did not leave enough space to make it worthwhile to try and attach it. If the poles had been used to make the structure for the hoop, hardware cloth would have been laid over the poles to and secured in place to finish the top. Over the hardware cloth, greenhouse plastic would have been stretched to make a waterproof roof. Drywall screws were used to fasten the entire frame together while nails were used to make the representative of the egg boxes. An in depth table of materials needed for full building this design can be seen below in Table 2. This coop is estimated to cost around \$200 when built to full scale.



## Designing a Mobile Chicken Coop

Table 2: Hoop Coop Materials List

Material	Size	Total Number Needed
Hardware Cloth	N/A	N/A
Carriage Bolt	1/4-20" x 4"	4
Carriage Bolt	1/2" x 4"	2
Cut Washer	1/4"	8
Cut Washer	1/2"	4
Lock Washer	1/2"	2
DBL Wide Zinc Corner Brace	2.5"	2
Plastic Wheel	6" x 1.5"	2
Aluminum or PVC Piping	1.5" x 12"	10
Small Hinges	N/A	16
Latches	N/A	8
Drywall Screws	2"	N/A
Untreated Wood	2" x 2"	N/A
Untreated Wood	2" x 4"	N/A
Untreated Wood	2" x 8"	N/A
Untreated Plywood Sheet	N/A	N/A

### **Feedback:**

All of our designs were sent out to two of the different farmers we had originally interviewed in order for them to critique them and give us valuable feedback to consider in our designs. Pam Raymond and her husband have critiqued many chicken tractors in the past she has compiled chicken tractor designs onto CDs with extensive information on the sizing, materials, pros and cons, and uses. She was a major influence in this design and we consider her feedback to be very important.

One of her main concerns was the weight of the coop. She suggested that instead of using 2"x4" lumber to use 1"x3" lumber where ever possible and to use 2"x3" lumber where structural strength is absolutely needed. This would cut the total weight of the coop almost by half. It was

## Designing a Mobile Chicken Coop

noted that having the egg boxes extending into the coop would allow for the birds to roost on them which would make an unnecessary mess to be cleaned. The egg boxes should be set flush against back of the coop to remedy this issue.

It was mentioned that corner bracing should be included to help the integrity of the rectangular base of the coop. In this design there were already diagonal braces in the corner to strengthen the coop. When the prototype was made, the rectangular base had no problems maintaining its shape. However, if the dimensions of the lumber were cut down and the scale of the coop was increased, structural problems may become evident and corner braces would be needed.

Since this coop has a maximum height of 4.5 ft, it was suggested that a taller door be worked into the design to allow for a greater ease of access for people. This would be difficult to incorporate, however, due to the vertical support that helps hold up the horizontal piece of lumber that spans the entire coop and becomes a handle. If that horizontal piece was removed, a new placement for the handles would have to be designed, but it would allow for one single large door to be placed at the front of the coop. If a new design with one large door could be proven to be structurally sound and have space for the new placement of the handles, it would be a much better option than the two small doors currently in the hoop coop design.

There was some feedback pertaining to the retractable wheel system in general. Although the 20" lever worked well in the small scale prototype, Pam thinks that it will be difficult to work on a larger scale. She suggests a 4' to 5' lever instead. This would allow for a greater moment to be applied to retract and detract the wheel with the same amount of force being used. In addition, a bolt that can be pushed through the brace and lever arm to secure it would be better than just a brace to oppose the movement.

Our second set of feedback came from Jack Kittredge who also was our main contact for NOFA and originally gave us a direction with our project. Jack's biggest concern was the weight of the coops. Once again, this can be addressed by cutting down the dimensions of the lumber used. He also suggested looking at different lighter materials, such as aluminum, that would be as structurally sound.

## Designing a Mobile Chicken Coop

A second concern was about the wheel system. While he did like the idea of the retractable wheel system, he was concerned with its ability to handle the terrain in Massachusetts. He suggested using larger wheels to assure that the coop could navigate all the rocks and dwells that could be on any given piece of land. The size of the wheels and the distance the wheel system lifts the coop off the group was specifically designed so that on flat ground there would only be a 2” gap. This was done with the intention to assure that no young chickens would accidentally slip out under the coop before they learn to move with it. That being said, the height the wheel system lifts the coop to and the size of the wheels can be easily adjusted to each individual case and need.

His last concern was with the handle. While the logic for the one handle was that it would assist in turning the coop and with the height it was at it could be placed on one’s shoulder, he thought that tow handles would make it easier for a person to lift. By changing the design to a two handle design, it lowers the amount of stress put on one part of the body. As discussed earlier with Pam’s comments, the single handle could be replaced with two handles but it would require reworking the structure to assure the system will work.

## 5.2 Hybrid Hoop Coop

### **Design Intent:**

This design is a hybrid between a standard Salatin style pen and a hoop coop, having the advantages of both. As you can see in the image below, Salatin style pens restrict the amount of space for the chickens. Hoop coops are generally small, as you can see in Figure 1, and with their semicircular shape, they cannot fit a large number of chickens. Because of these issues, this design sought out to incorporate both a rectangular coop with the addition of a hoop on the top. The intent of this design was to provide more room for the chickens to both roost and forage while ensuring they would be able to live in a habitable coop. Because of the size and the available space in the coop, this design is intended for small to large scale organic farmers who are looking for an alternative way to raise their chickens in a mobile coop. This design allows for the addition of staggered roosts which would give the chickens more elevation to roost while providing them with enough ventilation. With the extra room offered by this design, this coop can be used to hold a lot more chickens than an ordinary hoop coop while still providing them

## Designing a Mobile Chicken Coop

with the necessities they need to grow.



Figure 64: Salatin Pen

Source: <http://www.wellfedhomestead.com/joel-salatin-chicken-tractor-plans>



Figure 63: Hoop Coop

Source: <http://www.plamondon.com/hoop-coop.html>

### Parameters:

In order for this design to be successful, it had to be able to fit the needs of end users. After conducting our background research and interviewing farmers, we found the following criteria to be the most salient: portability, protection, cost, feasibility, and the use of non-toxic building materials.

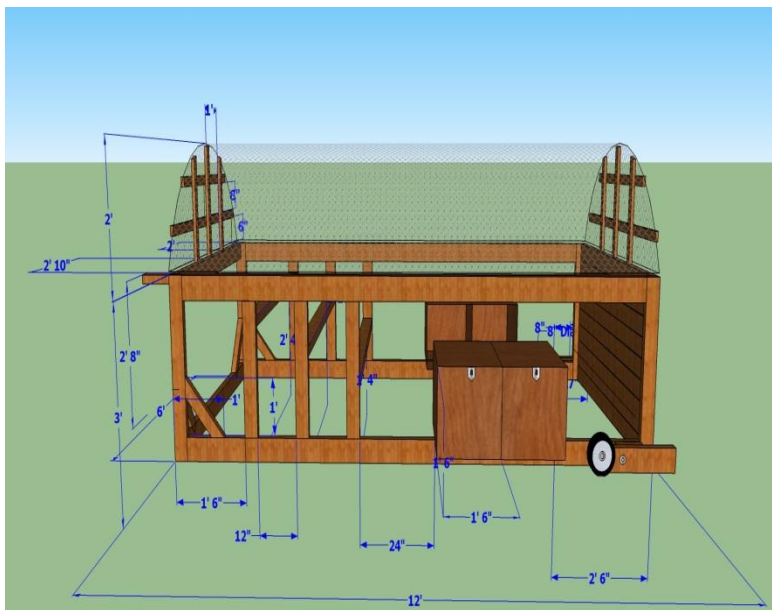

Figure 65: Full View of Coop

Google Sketchup Design

## Designing a Mobile Chicken Coop

### **Portability:**

The ability of the coop to move, its final weight, and its size were all taken into consideration. We decided that the coop would be able to move more easily with wheels rather than pushed as a sled or lifted by a dolly. The lighter the coop, the easier it would be to move. Therefore, the material selection was also a big factor. The coop also had to be big enough so that it could be used to house more than just a few birds. We realized that having a coop that was easily portable, would save the individual both time and effort. Allowing the coop to be moved by only one person was also very important because some chicken farmers go it alone.

Wood was chosen as the construction material because the coop had to be heavy enough to resist blowing over but light enough to be moved. To help with ease of portability, limiting the amount of wood while ensuring the coop's durability was prioritized. The coop also had to be a respectable size. The dimensions of this design are 6' x 12' x 5' high which is large enough to fit a wide variety of birds. To fit the needs of the farmer, the coop also needed to incorporate nest boxes in case the user decides to raise hens. For this design, the nest boxes are 1'6" x 1'6" x 2' long. This gives the hens plenty of room to lay their eggs. The nest boxes would open towards the outside of the coop to make the process of collecting eggs easier. If 4-5 chickens would use 1 egg box, then this design could be used for ~20 chickens.

This design incorporated a retractable wheel system (As seen in Figure 66: Wheel System ) which would allow the farmer to put the coop into position whenever they wanted to move it. The wheel system is divided into three parts: the wheel, the lever arm, and the block. The block is intended to give a little extra space from the coop for the wheels. The wheels, pneumatic tires with an 8" in diameter and 2½" thickness, are bolted into the lever arm which can be raised and lock into position to elevate the front end of the coop for movement. It was decided to use pneumatic tires because according to Pam Raymond, they make the coop easier to move. To aid in the movement, a 2" x 4" is bolted into the front to provide more stability and runs across the back of the coop to act as a handle. The handle is 2' 8" high off the ground so that it can easily be lifted to either pivot the coop or pulled to move the coop.



## Designing a Mobile Chicken Coop

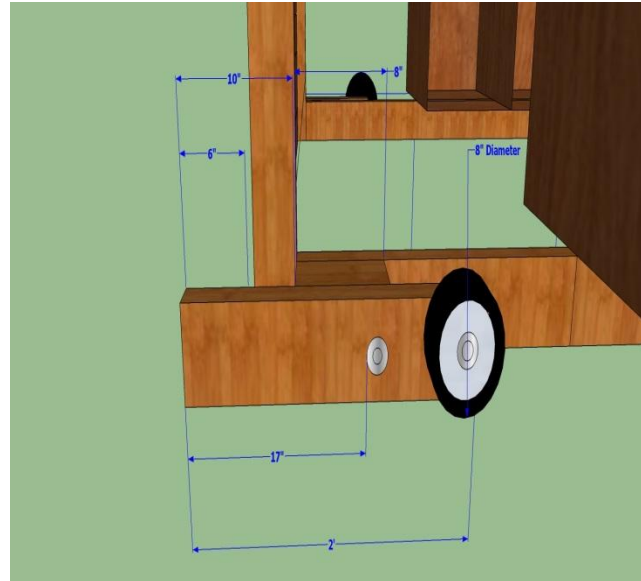

Figure 66: Wheel System

Google Sketchup Design

### **Protection:**

Protection was a huge concern for us in designing the mobile coop. We have learned that farmers have lost their chickens to both predators and extreme weather events. In order for the chickens to be well protected, the coop needed proper spacing, roofing, poultry netting, and ventilation. The spacing had to be adaptable to both small chicks and adult birds. It is recommended for adult birds to have about 2 square feet of room inside the coop. The roofing had to protect the chickens from aerial threats such as hawks while also preventing rainwater from leaking inside the coop and extensive heat buildup during the summer. In our design the roof is sloped to prevent the chickens from drowning during a heavy rainstorm. We tried to avoid using sheet metal for the roof since it can get very hot in the summer without proper shade. There also had to be poultry netting that covered the frame of the coop to protect the chickens from wild animals. Galvanized steel netting, particularly chicken wire or hardware cloth, is most commonly used and gave the benefit of ventilation as well. We learned, from Pam Raymond, that chicken wire was not effective enough in protecting the chickens from predators. This led us to using hardware cloth as poultry netting for our designs. Having a lock placed on the nest boxes would also help prevent predators from getting to the eggs. Lastly, there needs to be

## Designing a Mobile Chicken Coop

ventilation in the coop so that the chickens can grow and lay eggs without having to overcome

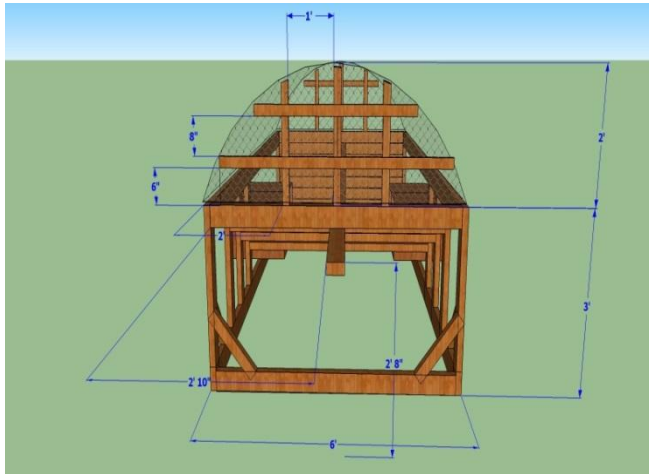

Figure 68: Hoop Section

Google Sketchup Design

high humidity or heat.

For this design, to aid in the amount of spacing, staggered roosts were implemented (see Figure 67) to help give the chickens more space underneath while providing them with enough height to roost. The roosts are about 6" apart from one another in height which is small enough for the chickens to jump onto. Each roost is 5' 8" long which gives plenty of room for chickens to sleep during the night. For the

roofing, this design used a hoop constructed out of cattle panel (See Figure 68). Cattle panel sheets can be bought up to 16' which is more than enough to cover 12' length of the coop. Both ends contained five 1" x 2" boards that would help contain the hoop shape. The cattle panel could then be fence stapled to the boards and the top frame of the coop to ensure the proper

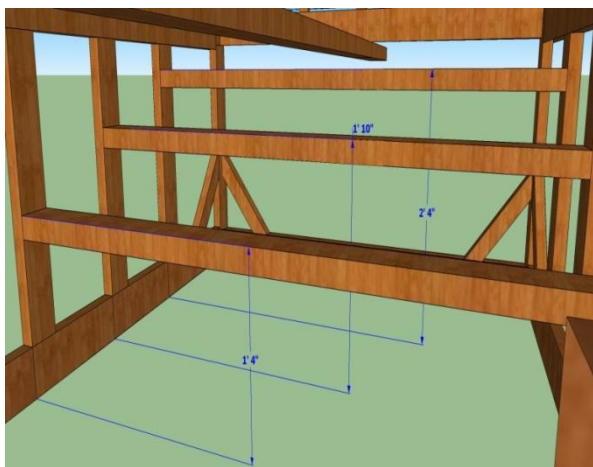

Figure 67: Staggered Roosts

Google Sketchup Design

fitting. Metal strapping can be used on the top frame of the coop and in the corners to securely hold the hoop's weight under stress. The hoop allows the staggered roosts to work by giving the chickens more vertical height to roost and it is also sufficient enough to protect the chickens from predation. A tarp can be placed over the hoop to give the chickens shade and to prevent rainwater from getting inside the coop. In order for the coop to be well ventilated, there had to be sufficient air flow. The hoop roof, compared to a

metal roof, would give the chickens that much more ventilation. . In addition, using a mesh pattern to cover the frame of the coop would give the chickens even more ventilation.

### Cost:

## Designing a Mobile Chicken Coop

Cost is always a factor in deciding the features of a particular design. We learned that the cost of our designs would come down to the materials we used. These materials include the roofing, the poultry netting, the frame, and the wheels. The hoop roof offered a cheaper solution because otherwise, the farmer would have to buy corrugated sheet metal to cover the top. They would also have to buy a reflective paint if they wanted to protect their chickens from overheating. While hardware cloth is more expensive than chicken wire, the benefit of protection outweighs the extra cost. We learned that the frame of the coop could be constructed out of either wood, PVC, or aluminum piping. It was decided that aluminum piping would not be cost efficient and we learned PVC would be too light, so we used wood as our primary frame for the coops. Wood is widely available and cheap lumber can be bought if the individual is on a tight budget. For the wheels, we used standard pneumatic lawn mower tires which can be a bit pricey but they are worth the cost. The overall cost estimate for building this coop would roughly be \$240.

### **Feasibility:**

Feasibility was taken into account because an organic farmer might not have the time or building expertise to construct a complex coop. This design was constructed out of materials, such as wood, hardware cloth, cattle panel, and tires that could easily be bought at a local hardware store. In order for someone to build a coop from scratch, they need the necessary tools to do so. This design is simple enough such that basic tools such as a hammer, a drill, and a saw can be sufficient enough to construct the coop. Basic knowledge of drilling screws, bolting wood together, hammering in nails, stapling cattle panel would be ideal for the construction of this coop. This design includes retractable wheels for ease of portability, a 32" x 28" door to get in and out of the coop, and a handle to assist in moving the coop.

### **Non toxic materials:**

In order for organic farmers to be labeled as 'certified organic,' they need to meet the USDA regulations. This means that mobile chicken coops need to be designed in a way that allows the farmer to support these standards. According to the USDA there can be no prohibited substances in organic production. This can pose a problem for farmers who opt to use pressure treated wood for their coop because of its rot resistant properties. Pressure treated wood contains

## Designing a Mobile Chicken Coop

pesticides, notably arsenic which is a toxic substance, which can leach into the soil over time. However, this design would use untreated wood so organic farmers would not have to worry about the leaching of arsenic. However, untreated wood will cause the wood to rot more easily so it is important for the farmer to maintain its integrity. With all the important objectives taken into consideration, this design will meet organic farming standards, ensure proper protection of the chickens from predators and the weather, and allow the chickens to live in a humane environment where they can be raised and lay eggs in a healthy manner.

### **Materials List:**

Table 3: Materials for the Hybrid Hoop Coop

<b>Items</b>	<b>Quantity</b>
Lumber	-
2in x 4in x 12ft	4
2in x 4in x 6ft	11
2in x 4in x 2ft 4in	6
2in x 4in x 5ft 8in	3
2in x 4in x 1ft 5 in	4
2in x 4in x 14ft	1
2in x 4in x 2ft	2
1in x 2in x 3ft 6in	2
1in x 2in x 5ft 6in	2
1in x 2in x 1ft 10in	4
1in x 2in x 2ft	2
4in x 4in x 8in	2
Nest Boxes 1ft 6in x 1ft 6in x 2ft	4

## Designing a Mobile Chicken Coop

Cattle Panel	-
Hardware Cloth	-
Tractor Wheels 8in 2½ in thick	2

### **Pros and Cons List:**

Pros	Cons
<ul style="list-style-type: none"> <li>The staggered roosts allow the chickens to roost at a higher height and gives them more room underneath</li> </ul>	<ul style="list-style-type: none"> <li>A tarp would have to be used to cover the hoop if it is going to rain so that the chickens wont drown</li> </ul>
<ul style="list-style-type: none"> <li>The coop has one handle that can aid the person in both positioning and moving the coop</li> </ul>	<ul style="list-style-type: none"> <li>Only having one handle might not be as comfortable to use compared to a coop having two handles</li> </ul>
<ul style="list-style-type: none"> <li>Retractable wheels are added to give more simplicity and ease of portability</li> </ul>	<ul style="list-style-type: none"> <li>The door (which is 32" x 28") is rather small so it might be tedious to get in and out</li> </ul>
<ul style="list-style-type: none"> <li>The coop has a fully enclosed side which can help protect the chicken and the coop from big gusts of wind</li> </ul>	<ul style="list-style-type: none"> <li>The fully enclosed side adds a lot of weight to the coop</li> </ul>

Table 4 Pros and Cons of Hybrid Coop

### **Feedback:**

Based on feedback from both Jack Kittredge and Pam Raymond, we note some possible changes to this design. Pam Raymond stressed making the coop as light as possible. Along with the hoop coop design, she recommended using 1"x3" lumber and 2"x3" lumber (when strength was necessary) instead of heavy 2"x4" lumber. The other general concern was the size of the egg boxes. It was indicated that the minimum sizes of egg boxes should be 12" wide x 15" long and



## Designing a Mobile Chicken Coop

13” deep to accommodate larger birds. However, nest boxes that are too large may mean that chickens would not use them. The nest boxes in this design are 18” wide x 24” long x 18” deep so making the nest boxes smaller would be beneficial. Also, the positioning of the nesting boxes are not very secure since they are only supported by the 2”x4” stud. . Either bracing would need to be added or the nesting boxes can be moved to the solid wall to fit 4 12”-15” wide nest boxes. Mounting them flush against the inside would prevent the chickens from roosting in them and they could be braced from the outside. For better protection, she suggested using locks that require an opposable thumb to function. Raccoons can easily figure out sliding locks so it is best not to use them. For mobility, it was suggested to use bigger wheels since it allows the coop to be moved much easier. Having wheels that were 10”-12” in diameter would be ideal.

Jack Rawson, our primary sponsor for NOFA, had similar concerns. He also was worried about the final weight of the coops and thought that our designs looked rather heavy. His other concern was the wheel system. Again, having smaller wheels would make it tough to navigate the coop across fields that contain a lot of rocks and dips. Larger wheels would allow the person to move a large coop much more easily. His last recommendation was to use two handles instead of one. While two handles would offer more comfort when moving the coop, it would add more weight and the structure of the coop would need to be altered to make sure the handles are spaced evenly apart.

### 5.3 Fully Enclosed Coop

#### **Design Intent:**

This coop in particular was designed with the intent of being kept inside a movable pen, which allows chickens to openly graze during the day without being attacked by predators. This coop will only house chickens at night, making it much different than our other designs. Since the chickens will not have to peck and fertilize within the confines of the coop, an open floor plan is not necessary. After discussing as a group, we decided having a solid floor for this type of coop is more advantageous since predators will be unable to dig under the coop at night and kill the flock. After talking with several local farmers, we discovered that solid flooring, although

## Designing a Mobile Chicken Coop

safer, is a hassle to clean, which led us to develop the idea of drop down flooring. A carpenter we spoke with states that supports about two and a half feet high with a square thickness of four inches will adequately and safely hoist the chicken coop off the ground. Because the coop is elevated, we concluded that the wheel system we established for the other two designs would prove too high a risk of tipping, thus we had to think about a new system of movement. After some research, we discovered a way of movement that involved PVC piping, as described in the Findings Chapter. This system would require runners to be attached along the bottom of the coop to ease the stress of pushing and make the process much smoother. Provided is a drawing made in a computer program of this coop as well as a pros and cons list which addresses various features of the design.

Figure 69: Fully Enclosed Coop

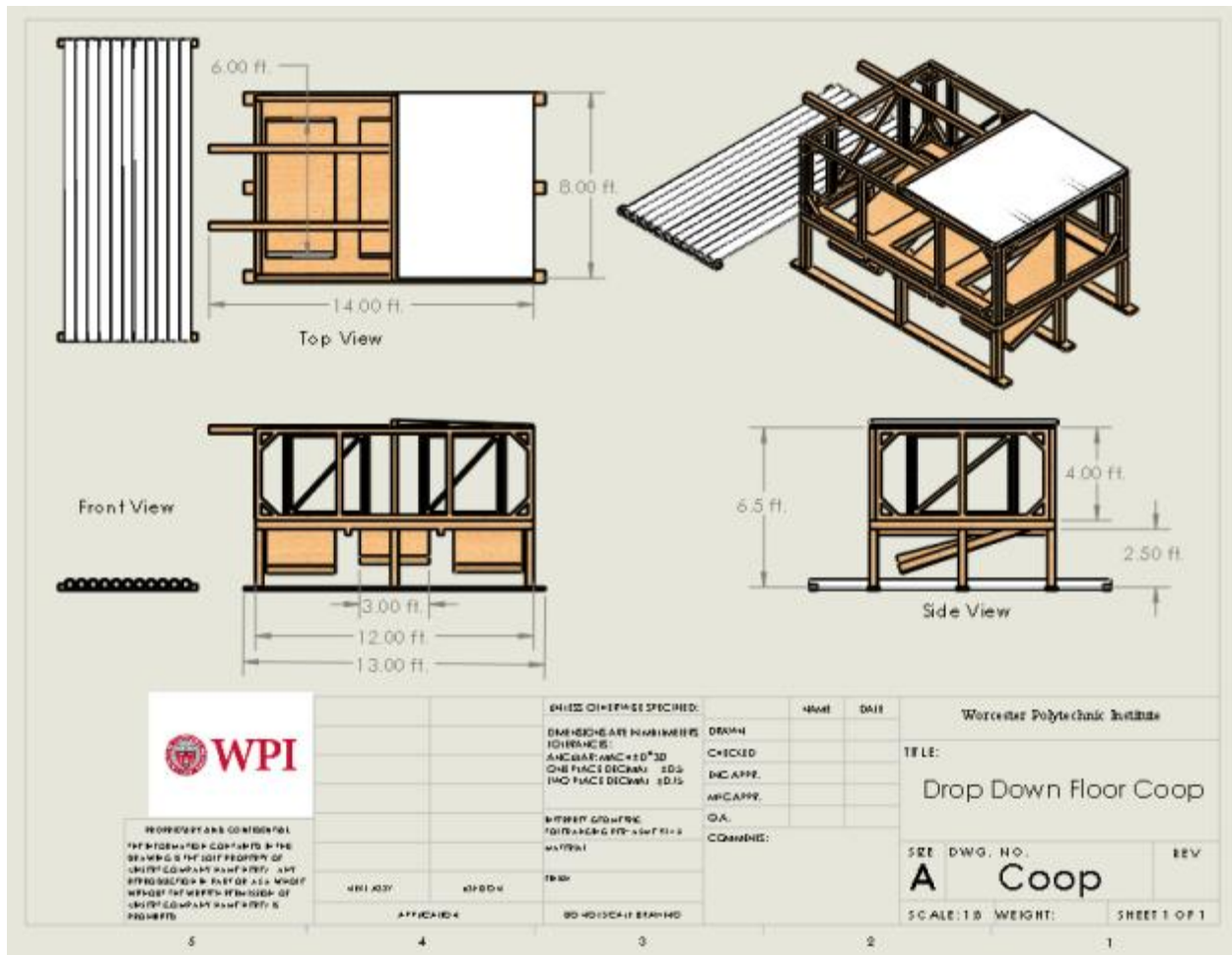

## Designing a Mobile Chicken Coop

### Design Parameters:

There were many parameters that needed to be considered when constructing our mobile chicken coops. The four main parameters that influenced many different aspects of our designs were feasibility, weight, protection, and its mobility.

### **Feasibility:**

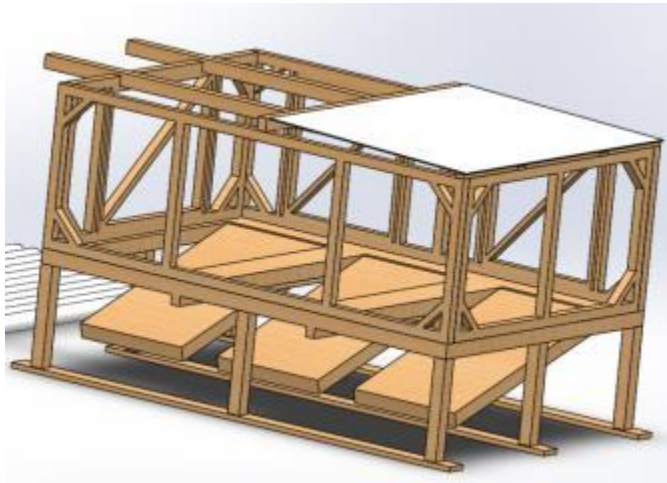

Figure 71: Personal Design, Drop Down Flooring

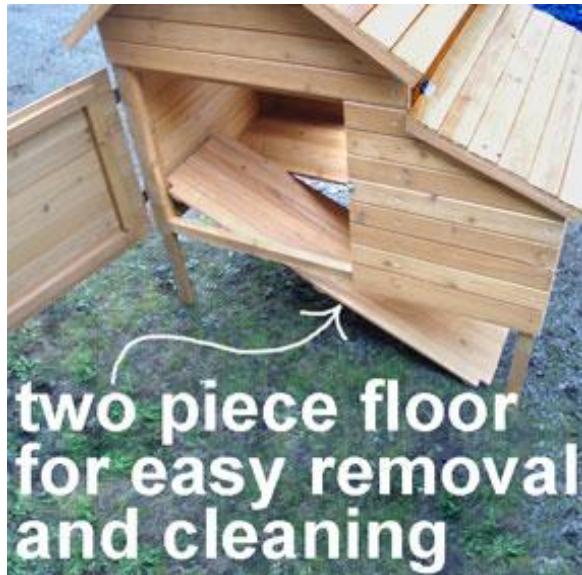

Figure 70: Drop Down Flooring

[http://www.growfruitandveg.co.uk/grapevine/rule-roost/chicken-coop\\_16012.html](http://www.growfruitandveg.co.uk/grapevine/rule-roost/chicken-coop_16012.html)

One major parameter we had to consider as a group was the feasibility of construction. Because our group had limited knowledge of carpentry and power tools, our designs did not incorporate much complex woodworking. This design in particular, appeared difficult to build due to its drop down flooring. After building a prototype, however, our group discovered

several simple methods, using different types of tools, which easily allowed the integration of drop down flooring into the design. The material chosen for this design, which is untreated wood, was also easy to build with since it only requires nails and screws to connect the individual pieces as opposed to complicated joints and accessories that other materials required. The most difficult aspects to construct are the corner supports since they require a forty five degree cut. However, this cut can be made using either a circular or handsaw and precise measurements. These simple angles are the most complex cuts that have to be

## Designing a Mobile Chicken Coop

made for this particular coop, again emphasizing the feasibility of its construction.

### Weight:

Our sponsors desired a mobile coop design that can easily be moved by one person, which makes weight an extremely important design parameter. This design is the heaviest out of all three due to its solid flooring. After talking with our advisors, our group agreed that plywood with a quarter inch thickness would serve as good flooring and would not weigh the coop down too much due to its thinness. This weight restriction also dictated what type of material this coop would be made from. Our group considered several different materials, as we discussed in the findings chapter, but we ultimately decided to only use wood for this design even though it would greatly increase the coop's weight. We came to this decision after concluding any type of metal would weigh the coop down too much, making it difficult to move, while PVC piping would not weight nearly enough while also having unbalanced weight distribution that would make moving the coop more difficult. As seen from the figure below, the coop will consist mainly of wood, making it moderately heavy.

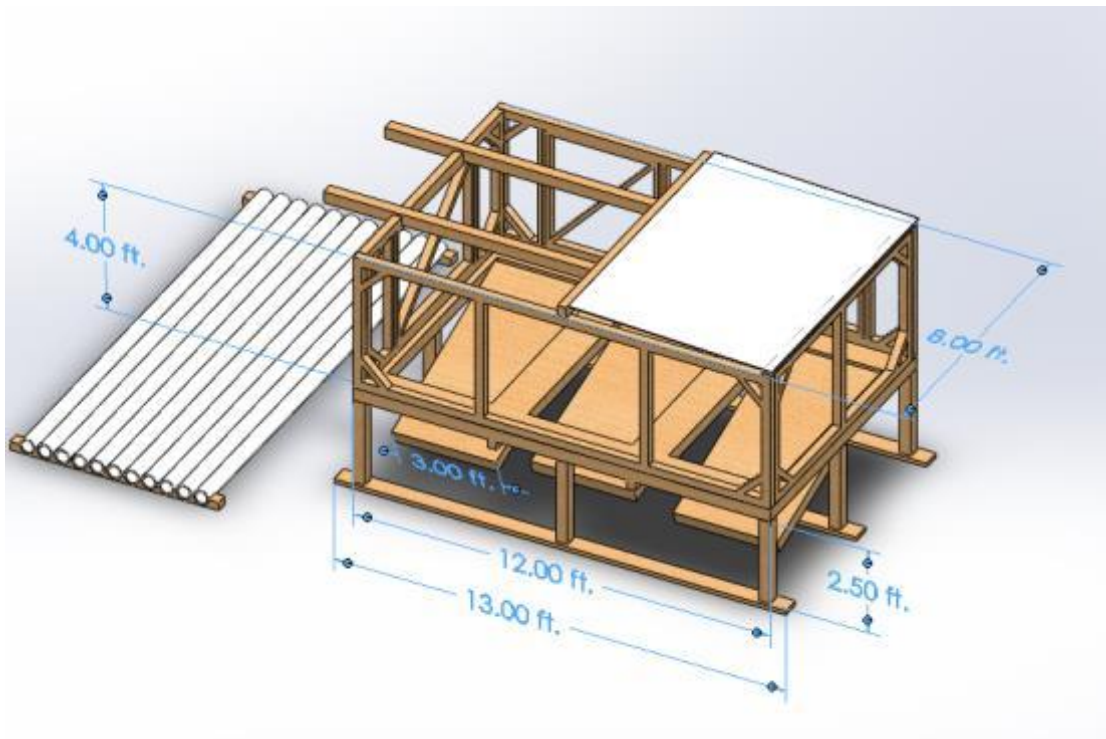

Figure 72: Personal Design, Structure of the Coop



## Designing a Mobile Chicken Coop

### Protection:



Figure 74: Movable Pen

Photograph courtesy of Pam Raymond

Protecting the flock became a major concern when designing these coops, since the flock is the most valuable resource to organic chicken farmers. This coop design utilized solid flooring to serve as an extra layer of protection to prevent critters from digging underneath and gaining access to the chickens. The movable pen also acts as another layer of protection since it resists attacks made by aerial threats, such as hawks or other large birds. As pictured in Figure 74, the ropes attach to the pole in the middle of the pen and separate to different endpoints of the outside perimeter, which disallows any aerial predator from entering the area. Many land predators also reach their claws into the coop and rip the birds' heads off as well as other body parts, instantly killing them. Because of this, we had to surround the perimeter of the coop with hardware cloth so that predators cannot touch the flock. Though some farmers use chicken wire, our group



Figure 73: Chicken Wire and Hardware Cloth

<http://www.livingthat.com/top-4-uses-chicken-wire/>

<http://westphoria.sunset.com/2008/05/12/thinking-outsid/>



## Designing a Mobile Chicken Coop

deduced that the gaps in chicken wire are too big and may still allow small predators, such as mice or rats to gain access and endanger the chickens. An attachable run was also added, not only so the chickens can leave and enter easily, but so predators cannot climb the run at night and gain access to the front of the chicken coop. There are two figures above. The left depicts chicken wire on a coop, note the larger gaps, while the figure on the left shows hardware cloth.

### Mobility:



pipings where it would roll across the

**Figure 75: Roller System**

<http://www.backyardchickens.com/t/362682/coop-tractor-wheels>

pipes to its new location. This type of wheel system works well on hilly terrains as seen in Figure 75. The length of the PVC piping can be fixed in order to fit any situation. The one downside of this type of system is the lack of ability to maneuver sharp or curvy turns.

As previously stated, because the coop is elevated on relatively thin supports, our group made the decision to utilize a new system of movement which appeared much more stable for this type of coop. After some research, we concluded a PVC roller system would work best, since it used the most surface area and, therefore, appeared to be least at risk of tipping. As seen in Figure 76, runners are attached to the bottom of the coop's supports with three inch screws. The runners allow for a more smooth transition across the PVC piping. In order to move the coop, one would just have to lift the coop using the handle located on the front and place it on PVC

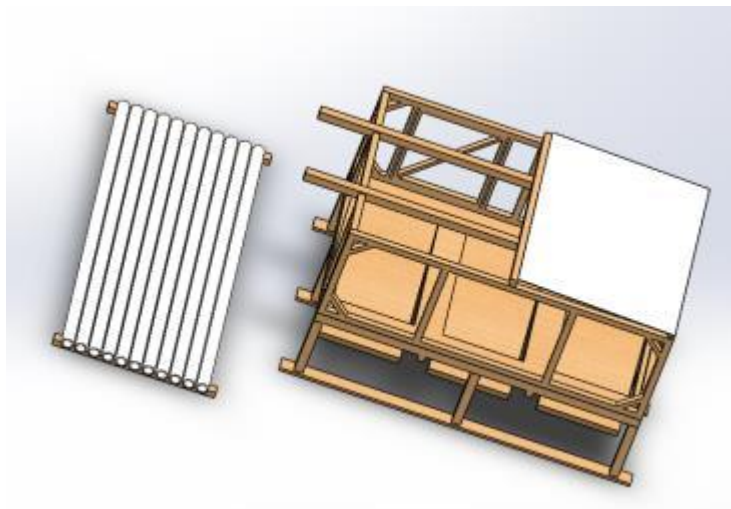

**Figure 76: PVC Wheel System Design**

## Designing a Mobile Chicken Coop

### Pros and Cons List:

Pros	Cons
<ul style="list-style-type: none"><li>• The solid flooring ensures that predators cannot dig underneath the coop.</li></ul>	<ul style="list-style-type: none"><li>• The solid flooring adds extra weight that will be difficult to move around.</li></ul>
<ul style="list-style-type: none"><li>• The dropdown flooring allows for easier cleaning as well as easier access to the flock.</li></ul>	<ul style="list-style-type: none"><li>• The solid flooring also costs extra which puts a strain on the budget.</li></ul>
<ul style="list-style-type: none"><li>• Chickens do not need as much room since they are only sleeping in the coop. This means the coop can be smaller, thus saving materials and money.</li></ul>	<ul style="list-style-type: none"><li>• Chicken owners must be available every night at dusk to lock the chickens in the coop, which is not ideal for hobbyists that do not want the chicken farming lifestyle to dictate their schedule.</li></ul>
<ul style="list-style-type: none"><li>• The coop does not have to be moved as often since it is enclosed in the pen, which saves time and energy.</li></ul>	<ul style="list-style-type: none"><li>• The coop will have to be cleaned out every few weeks, which can be time-consuming.</li></ul>

Table 5 Pros and Cons of Fully Enclosed Coop

### Prototype:

A prototype of this coop was created in order to address any construction difficulties and test whether this particular coop was possible to build without much previous woodworking and power tool knowledge. This prototype was ¼ of the coop that was designed, so many of the materials were scaled down and some components, such as corner supports, were left out. Many tools were used during the construction of the prototype, including a handsaw, table saw, circular saw, a drill, a hammer and various screws and nails, which are commonly owned by many people. Through this process, we learned many things, which were discussed in the Findings chapter and include the necessity of wearing a facemask when cutting the wood and which building methods provide more stability to the coop. Below are pictures of the prototype that was built.

Designing a Mobile Chicken Coop



Figure 77 Front of Prototype



Figure 78 Front Door

## Designing a Mobile Chicken Coop

### **Materials List:**

<b>Items</b>	<b>Quantity</b>
Lumber	-
2'' X 4'' X 12'	4
2'' X 4'' X 8'	6
2'' X 4'' X 4'	12
2'' X 4'' X 20'	1
4'' X 4'' X 20'	4
1/8'' X 4'' X 12'	2
2''X2''X6'	1
1/8''X4''X6'	1
2'' X 2'' X 4'	8
2'' X 2'' X 10'	1
1/8'' X 4'' X 8'	1
2'' X 4'' X 1'	1
Hinges	12
Slide Bolt Latches	9

Table 6: Materials List for the Fully Enclosed Coop

A more detailed list of materials is provided below.

### **For Frame:**

- Four pieces of 2'' X 4'' X 12' untreated plywood
- Six pieces of 2'' X 4'' X 8' untreated plywood
- 12 pieces of 2'' X 4'' X 4' untreated plywood
- One piece of 2'' X 4'' X 20' untreated plywood for 16 corner supports; each 15 in long
- Four pieces of 4'' X 4'' X 20' untreated plywood for bottom supports that elevate the coop (4'' X 4'' X 2.25' each)
- Two pieces of 1/8'' X 4'' X 12' untreated plywood for lateral runners

## Designing a Mobile Chicken Coop

### **For Doors:**

- For front door with run attachment:
  - Four pieces of 2'' X 2'' X 4' untreated plywood for door frame
  - One piece of 2'' X 2'' X 6' untreated plywood for diagonal support **OR** instead of diagonal supports, use steel corner joints
  - Two hinges
  - One slide bolt latch
  - One piece of 1/8'' X 4'' X 6' for run
  - Three picture frame attachments to secure run to coop
- For two doors on side:
  - Eight pieces of 2'' X 2'' X 4' untreated plywood for door frame
  - One piece of 2'' X 2'' X 10' untreated plywood for diagonal support **OR** instead of diagonal supports, use steel corner joints
  - Four hinges
  - Two slide bolt latches

### **For Floor:**

- One piece of 1/8'' X 4'' X 8' thin plywood for flooring
- One piece of 2'' X 4'' X 1' for wooden latches that will help secure drop down floor
- Six hinges
- Six latches

### **Feedback:**

We received feedback for this coop inside a movable pen design from two of the farmers that we originally interviewed. Their insight and advice can improve this design and will prove to be helpful for those wishing to construct a coop such as this.

In the computer generated design images that we provided in this chapter, there are no roosts or egg boxes inserted since this proved to be too difficult to computationally generate. However, in the hand-drawn images, which can be found in the Appendix C, there are several

## Designing a Mobile Chicken Coop

sketches in which there are both roosts and egg boxes. Pam Raymond advised to elevate the roosts so that they are thirty inches off of the ground, which would allow for a sufficient eighteen inches of headroom for the birds. She also suggested lifting the nest boxes so that they are eighteen inches from the floor instead of seven, ensuring they are high enough off the ground, but not too high that the chickens will be tempted to sleep in them.

The reviewers were not only concerned about the internal structure of the coop, but also its heavy weight. Pam suggested bracing diagonally across each corner at the top with 1''X3'', rather than the heavy 2''X4'' pieces of lumber that span across the length of the coop. This would greatly affect the design since the pieces of lumber spanning the coop also act as handles, so another handle design would have to be thought out and constructed.

There were also concerns over whether this coop provided adequate protection against predators. The use of slide bolt lock used to secure the doors were a point of concern since they can easily be opened by predators, such as raccoons. It was advised to use latches that a predator cannot figure out and need an opposable thumb to operate.



## 6. Concluding Remarks

### 6.1 Who this Appeals to:

Both large and small organic farms, urban farmers, and backyard farmers that raise chickens are always looking for way to increase their productivity while decreasing the amount of effort they have to put in. Areas that are generally focused upon for improvement are the cost of feed, the cost of the coop, amount of annual maintenance needed, and the health of the birds. While the cost and maintenance of the coop can be addressed by the materials used, the cost to feed the birds and their health can be positively affected by using a mobile chicken coop.

Chicken tractors are appealing to people who are raising or want to raise chickens due to a number of benefits. Using a chicken tractor will cut down on the cost to feed the birds because the chickens are allowed to scratch at the ground and eat insects like they would if they were free range. In addition, the mobility of the coop allows for a large amount of area to be naturally fertilized by the birds which will increase the productivity and profit of other aspects of farming. Mobile chicken coops keep the birds happier and healthier than they would be in a traditional chicken coop because of the access to insects and the cleanliness of being able to move an entire flock to a new piece of land whenever necessary.

### 6.2 Improvements to Mobile Chicken Coops:

There were many aspects about mobile chicken coops already on the market that we wanted to improve upon over the course of this project. The key parameters that we tried to enhance were mobility, protection against predation, and maintenance needed. By the end of our project, we managed to address and come up with significant improvements for both mobility and protection against predation. Ways to decrease the amount of maintenance needed were investigated but no significant solutions were found.

#### **We designed different wheel systems to increase the mobility of chicken tractors.**

Two different wheel systems were designed to address the mobility of mobile chicken coops. The first system was a set of two retractable wheels to be placed on the back end of a coop with a single handle at the front. This arrangement was made to lift the coop about two

## Designing a Mobile Chicken Coop

inches off the ground when moving it and then gave the coop the ability to be as flush as possible with the ground when stationary. The retractable wheels were designed to work well with open bottom coops by allowing for greater mobility while decreasing the chance of a bird slipping out.

The second system was designed to help improve the mobility of closed bottom mobile chicken coops, especially those placed on skids. It consisted of PVC pipe rollers that would be placed in front of the chicken coop so that it could be easily rolled across. Using a roller system helped us to address possible deformation of wheels due to the added weight a fully enclosed chicken tractor may have due to having solid flooring.

### **We extensively focused on predation prevention for all chicken coops.**

Through our background research and interviews, we managed to design our chicken tractors to protect chickens from predators. Predation is a serious problem for every poultry farmer whether they are a large or small scale farm or just a backyard farmer. Some of the key preventative measures that we found were electric fencing, digging deterrents and strong latches. The electric fencing is a good first defense to essentially train predators not to go near a chicken coop. However, many times these fences can be jumped over so it is not good to use as the only line of defense. Once predators are within a close proximity of a coop digging becomes a big problem. A good solution is to lay down chicken wire on the ground around the chicken coop. The predators will try to dig but cannot get through the wire and will not attempt to step further back and dig up the wire. Lastly, it is always important to securely close a coop every night. Raccoons are notorious for being able to open latches so investing in higher quality heavy duty latches is important.

## **6.3 Future Projects and Research:**

### **We recommend creating a chicken coop equipped with simple automation.**

After speaking with many farmers, we discovered that a chicken coop with the ability to move itself a fixed distance at certain intervals throughout the day would ease the burden of manually transporting the chicken coop. We suggest students with extensive robotics, ECE or Computer Science knowledge to create a code and assembly that would place the coop on a timer and when the timer goes off, the coop would move a distance set by the farmers. This automation

## Designing a Mobile Chicken Coop

would be ideal because it would appeal to all classes of farmers. Hobbyists would not have to compromise their schedules in order to move a coop and self-sufficient and full-time farmers would save large amounts of time since they would not have to move their sizable coops several times a day.

### **For the mobile coop inside of a movable pen, we recommend a self-shutting door.**

The design for a mobile coop within a pen does not appeal to all of our audience, since it requires farmers to accommodate their schedules so that they are home every night at dusk to shut the door of the coop. This comes as an inconvenience to many hobbyists who do not wish to change their lifestyles for their chickens. However, if the door is not closed every night, then the chickens become very vulnerable to predators that can easily gain access to the coop. After showing this design to a local farmer, we were given the suggestion of automating a coop door that would be set on a timer that would close the door every evening at dusk, safely securing the chickens in their home.

### **We recommend further research different materials from which a mobile coop can be made.**

After large amounts of research, our group narrowed the material choices of our mobile tractors down to untreated wood, aluminum piping and PVC piping. We ultimately decided to build our coops out of untreated wood, though we would like to see other designs consisting of different materials. With PVC piping, we were concerned about the coop being too light weight. Some people suggested weighing the PVC pipes down with sand in order to increase their weight, however, this would lead to unequal weight distribution throughout the coop. The sand would sink to the bottom of the structure, leaving the top part very light and susceptible to attacks from predators. We recommend finding a way so that PVC piping may be used, but with equal weight distribution. We also suggest finding cheaper alternatives to aluminum piping, since this particular material, along with many other types of metals, can be very expensive, especially in large quantities that a sizable mobile coop requires.

## Designing a Mobile Chicken Coop

### **We recommend purchasing electric fencing to surround the perimeter of the farm.**

After talking with an electric fence enthusiast at the NOFA conference, our group received the suggestion of equipping the area around the coop with electric fencing. This would provide an extra layer of protection and would ensure the predators would not be able to gain access to the flock.

### **We recommend creating a coop with a retractable roof.**

Another suggestion we received at the NOFA conference was to equip the mobile coops with a retractable roof. Many farmers with shorter coops have to crawl around on the ground in order to have access to their chickens. This retractable roof would allow easy entry into the coop, without having to crawl on the ground. For the mobile coop within a movable pen, the retractable roof would also allow for easier cleaning, saving time and energy for many farmers.

## References

- Al-Malack, M. H. (2001). Migration of lead from unplasticized polyvinyl chloride pipes. *Journal of Hazardous Materials*, 82(3), 263-274.
- Bailey, Z., Guo, D., Jaoude, H. A., Pawlowski, A., Hosford, J., Burgin, A., et al. (2010, December). Chicken Shelter. *UBC CSL - CIVL 201*. Retrieved November 9, 2013, from <https://circle.ubc.ca/bitstream/handle/2429/30357/Chicken%20Shelter.pdf?sequence=1>
- Bourn, D., & Prescott, J. (2002). A comparison of the nutritional value, sensory qualities, and food safety of organically and conventionally produced foods. *Critical reviews in food science and nutrition*, 42(1), 1-34.
- Brandon, J., Collins, N., & Reiter, B. (2011). Chickens in the City: Yes, in My Backyard. *Journal of Agricultural & Food Information*, 12(1), 118-127.
- Coop tractor wheels. (n.d.). *BackYard Chickens*. Retrieved December 17, 2013, from <http://www.backyardchickens.com/t/362682/coop-tractor-wheels>
- Danaan, C. (2011). *Way of the Hen: Zen and the Art of Raising Chickens*. Globe Pequot.
- Do It Yourself: Lumber Grades Explained. (n.d.). *Essortment*. Retrieved October 2, 2013, from <http://www.essortment.com/yourself-lumber-grades-explained-54773.html>
- Grow Your Own Magazine. (n.d.). *Chicken Coop*. Retrieved November 10, 2013, from [http://www.growfruitandveg.co.uk/grapevine/rule-roost/chicken-coop\\_16012.html](http://www.growfruitandveg.co.uk/grapevine/rule-roost/chicken-coop_16012.html)
- Hermes, J. (n.d.). Seasonal Changes affect Poultry. *Oregon Small Farms*. Retrieved November 6, 2013, from <http://smallfarms.oregonstate.edu/sfn/f07poultry>
- Hole, D., Perkins, A., Wilson, J., Alexander, I., Grice, P., & Evans, A. (2005). Does organic farming benefit biodiversity?. *Biological Conservation*, 122(1), 113-130. Retrieved November 30, 2013, from <http://www.ecosensus.ca/Hole2005.pdf#lbib50>
- Schassler, Kathleen. "Farms Sow More Organic Acres, As Demand Rises." *Connecticut Health Investigative Team*. N.p., 27 Feb. 2014. Web. 05 Nov. 2013.
- Keppel, W. (n.d.). *ManagingWholes.com*. *Portable pens for pastured poultry: designs that beat heat, wind, and rain*. Retrieved January 22, 2014, from <http://managingwholes.com/poultry-pens.htm>
- Long, C. (n.d.). Build an Affordable, Portable and Predator-Proof Chicken Coop. *Mother Earth News*. Retrieved December 5, 2013, from <http://www.motherearthnews.com/diy/how-to-build-a-chicken-coop-zm0z11zhun.aspx#axzz2e2vWkP8Y>
- Masi, B. (n.d.). Defining the Urban-Agrarian Space. *Cities Growing Smaller*. Retrieved November 28, 2013, from [http://cudcserver2.cudc.kent.edu/publications/urban\\_infill/cities\\_growing\\_smaller/cities\\_growing\\_smaller\\_chapter\\_07\\_screen.pdf](http://cudcserver2.cudc.kent.edu/publications/urban_infill/cities_growing_smaller/cities_growing_smaller_chapter_07_screen.pdf)
- McConahey, M. (2013, April 26). Tips from the coop experts. *McClatchy - Tribune Business News*. Retrieved

## Designing a Mobile Chicken Coop

December 10, 2013, from <http://search.proquest.com/docview/1346151920>

Merah, N. (2007). Natural weathering effects on some properties of CPVC pipe material. *Journal of Materials*

*Processing Technology*, 191(1–3), 198-201. doi:  
<http://dx.doi.org/10.1016/j.jmatprotec.2007.03.031>

Muntz, S. (n.d.). Opportunities in the Evolving Range/Pastured Poultry Industry. *Heifer Project International*.

Retrieved October 4, 2013, from  
<http://www.nal.usda.gov/afsic/nsfc1999/Steven+Muntz.pdf>

Neufeld, E. A. (2002). *Consumer Preferences for Organic/free-range Chicken* (Doctoral dissertation, Kansas State University).

Pest Eating Chickens Play Role in Creating Sustainable Agriculture Systems. (n.d.). *Seedstock*. Retrieved October 4,

2013, from <http://seedstock.com/2012/08/12/pest-eating-chickens-play-role-in-creating-sustainable-agriculture-systems/>

Poole, T. (n.d.). Introduction to Developing a Free-Range Poultry Enterprise. *University of Maryland Extension*.

Retrieved December 3, 2013, from  
[https://www.extension.umd.edu/sites/default/files/\\_docs/locations/frederick\\_county/Ag%20Pubs%20A%20Supplement%20to%20Free%20Range%20Poultry.pdf](https://www.extension.umd.edu/sites/default/files/_docs/locations/frederick_county/Ag%20Pubs%20A%20Supplement%20to%20Free%20Range%20Poultry.pdf)

Rhodes, C. J. (2012). Feeding and healing the world: through regenerative agriculture and permaculture. *Science*

*Progress*, 95(4), 378+. Retrieved from  
[http://go.galegroup.com/ps/i.do?id=GALE%7CA320589588&v=2.1&u=mlln\\_c\\_worpolp&it=r&p=ITOF&sw=w&asid=dc5f2b2271af0cced199e73b469c250](http://go.galegroup.com/ps/i.do?id=GALE%7CA320589588&v=2.1&u=mlln_c_worpolp&it=r&p=ITOF&sw=w&asid=dc5f2b2271af0cced199e73b469c250)

Rossier, J. (2004). *Living with chickens: everything you need to know to raise your own backyard flock*. Globe Pequot.

Seaman, G. (n.d.). Eartheasy. *Eartheasy Blog Our Top 6 Chicken Raising Mistakes Comments*.

Retrieved November 7, 2013, from <http://eartheasy.com/blog/2012/07/our-top-6-chicken-raising-mistakes/>

Trewavas, A. (2001). Urban myths of organic farming. *Nature*, 410(6827), 409-410

Tubing Strength for Mechanics. (n.d.). *Mechanic Support*. Retrieved October 8, 2013, from  
[http://www.mechanicsupport.com/tube\\_strength.html](http://www.mechanicsupport.com/tube_strength.html)

Uses For Chickens. (n.d.). - *Raising Chickens*. Retrieved October 3, 2013,  
from <http://www.wilderness-survival.net/uses-for-chickens>

Wolpe, M., & McElroy, K. (2013). *Reinventing The Chicken Coop: 14 Original Designs With Step-by-Step Building Instructions*. Storey Publishing

Wood as construction Material. (n.d.). *Civil Engineering*. Retrieved October 24, 2013,



## Designing a Mobile Chicken Coop

from <http://www.aboutcivil.org/Wood%20as%20construction%20material.html>

## Appendices

### Appendix A: Interviews

#### A.1 Interview with Jack Kittredge

##### Introductions

- Introduce ourselves and learn more about them.
- How long have you both been organic farmers?
- How do you raise your chickens? How does one go about raising chickens?

##### Questions

- What do you know about the history of NOFA?
- What kinds of people belong to the organization?
- How does NOFA share information and designs like this?
- How is NOFA going to be involved in this project?

##### Purpose

- What are the different uses for different kinds of chicken tractors?
- Why did you want us to build one?
- What is the problem we are trying to solve?

##### Audience

- Who is going to be using the chicken tractor?
- Who else do we need to/should talk to?
- Are there other nearby examples of chicken tractors we should look at?
- How should solicit the view and interests of the NOFA members in a chicken tractor/the type?
- How can we distribute the work we do to interested NOFA members and others?

##### Design Parameters

- What size should it be? How many chickens should it be able to hold?
- What kinds of materials should we be using?
- What are our constraints? (i.e. weather, terrain, available labor to move it, storage, etc.)

## Designing a Mobile Chicken Coop

- What is our cost range?

### **Deliverables**

- Do you want one full scale/almost full scale product?
- Do you want multiple different small scale prototypes?
- Do you want us to present at the NOFA Winter Conference?

### **Notes from Interview with Jack Kittredge**

- The Many Hands Farm was certified organic in 1987.
- Julie grew up on a farm while Jack grew up in a suburban.
- They feed their chickens certified organic Kremer feed Nature's Best line and sprout grains (wheat oats, barley, and kelp meal).
- The chickens are out in the mobile chicken coops in the grass pastures from about April 15<sup>th</sup> to October 30<sup>th</sup>. Rest of the year they have access to a chicken coop and are free range during the day.
- They get day old chicks and raise layers, meat birds, and turkeys.
- They use Kosher King chickens for meat birds instead of the usual white Cornish crosses that are bred for breast meat. The white Cornish crosses are not well suited for ranging due to many immune system issues and weak legs. The chickens they use are a bit more suited for ranging but take twice as long to get to market weight.
- NOFA was inspired by people fed up with the Vietnam War, our culture, so they turned to the purest thing they could think of, farming.
  - But they were in over their head.
  - They made self help groups
  - They eventually started developing organic certificates
- Jack and Julie got involved in the early 1980s. It turned into a part time job of sorts.
- In 2002 the certifications split off and the feds became in charge of it. NOFA stopped doing organic certifications themselves just so they didn't have to deal with that all.
- The present profile involves a lot of education and advocacy.
- There are nine full time employees working for NOFA at the present.
- NOFA members are: generally more educated than not, independent, leaders in their communities rather than followers, people with environmental consciousness, a lot of

## Designing a Mobile Chicken Coop

students, and usually not people **just** interested in good foods. Usually have part of their living as farmers/active gardeners.

- Ways we can get our ideas distributed: publishing in the newsletter and the winter conference.
- Jack will be involved, since he is technically our advisor, with setting the tasks and helping us with connections with other farmers.
- Egg layer coops will need a place for the eggs to be laid and the birds like to roost.
- Meat birds don't tend to roost.
- Turkeys like to roost but are heavier than chickens.
- **If the birds are in open air you will build up a population of predators. People want to keep as open a pasture and as movable as possible while keeping their birds safe.**
- Layer chickens can get up to 25% of their diet from the grass. This helps save money.
- Jack and Julie's dogs help with security by chasing off coyotes. We may want to think of a way to secure the coops from coyotes being able to dig under them in case someone doesn't have dogs.
- There are organic fertilizer standards. Such as fresh manure cannot be used on produce.
- Our coop needs to be relatively light so people (NOT MACHINES) can move it.
- It needs to resist predation, so heavy enough not to tip and so it is secure.
- Our coop needs a roof.
- Most coops are built out of wood **but organic farmers cannot use pressure treated/chemically treated wood.** Untreated wood does not last long with ground contact.
- Plastic lumber may be a good choice but it is expensive and heavy. Also, once it is cut down to size it may not be as strong as wood.
- Aluminum piping might be ideal but we may not be able to easily get the joints and fixtures.
- We want our materials to be light, strong, inexpensive, and adaptable.
- Roosts would be nice and a spot for egg layers.
- It needs to be accessible by people.

## Designing a Mobile Chicken Coop

- The slope of the roof needs to shed water and we need to avoid having any dents in it so the water won't pool.
- We need to have food and water in the coop and the food needs to be protected from windy rain storms so the food won't get wet and rot.
- We need to think about if one older person would be able to move our coop.
- Jack and Julie's coops need two people and a two wheel lift to move theirs.
- Jack has seen some one person designs. Look at Backyard Poultry.
- We need to think about if our coop will work on land that isn't completely flat with short grass.
- He knows of coops as small as 3'x6', so 5-8 chickens. We want 2sq ft per bird in our coop.
- Jack and Julie's coops are 8'x12' and hold 100 baby birds and 35 adults.
- You can tell if there isn't enough room is birds start dying.
- We have the emails from the two farmers who also have mobile chicken coops and knowledge about them. We may want to visit them.
- We can ask people to give their ideas through the newsletter but we need to talk to the women in charge ASAP if we are going to get that in the October newsletter.
- We can join the gardener's list serve (I am not sure if I got that right). It is on the front page of NOFA. We can ask questions there and people are free to answer us.
- Andy Lee and Joe Salatin. They are important people with early designs.

### A.2 Notes from Interview with Pam Raymond

- Nests:
  - If you want hens to lay, they need as much privacy as possible, so the more you can block off or cover of the egg nests, the happier the hens will be
  - You can use fabric to create a curtain for added privacy
  - There should be one nest per every three birds
  - Look into making the egg boxes have an opening in the coop but the entire box being outside of the coop for easier retrieval and internal space saving

## Designing a Mobile Chicken Coop

- Roosts:
  - Wider roosts are preferable since it allows chickens to sit on the roost and bury their feet as opposed to grabbing it with their claws. Wider roosts prevent against frostbite too
  - Roosts must be at least eighteen inches from the roof of the coop and at least a foot from the floor
  - Roosts must also be higher than the nesting boxes by at least two inches, so chickens are more apt to sleep on the roosts as opposed to inside the nesting boxes where they will create a mess
  - Staggering the roosts can create more room for the birds, but it might also add extra weight
  - Stepped roosts help for the different sizes of the birds as it grows, flooding is a problem for little birds.
  - We need to think about how they will be cleaned
- Water and Food:
  - Feeders and water should be able to be raised and lowered, so that they can always be at the height parallel to the birds' backs. This prevents food from being wasted, since they will be less apt to fling the feed.
  - The round yellow feeders with dividers are much better than trough feeders.
    - Trough feeders have major problems with mice
    - Chickens are more likely to fling the feed and waste it if it were put in a trough
    - Yellow feeders have individual holes
    - Yellow feeders take up more space than trough, but saves farmers a lot of money on feed
      - Pam wants two feeders in her mobile coop, but they take up too much room
  - If their water is too hot or cold they will not drink and they need water to digest their food.

## Designing a Mobile Chicken Coop

- When using a bell waterer, put the hole in the reservoir a few inches up to keep it from clogging.
  
- Movement:
  - Four wheels may be hard to turn
  - Two wheels make it easier to turn but harder to move long distances
  - Pneumatic tires are much better than rubber tires
    - 3 to 4 inch thickness is ideal
  - Must be aware to the threat of tipping
  
  - We need to think about how we are going to be able to see the birds as the coop is being moved.
  - If the birds are always staying in the coop they need to be moved at least once a day.
  
- To prevent against predation and other threats:
  - Predation
    - Electric fencing is good for protection against predators but people do not always have a way to power it
    - Staking chicken wire into the ground around the coop will prevent from too much digging
    - Double snaps are good at fastening coops and will prevent raccoons from killing chickens
    - Hardware cloth is ideal since many predators can reach through chicken wire or pry the wire off of the coop
      - Can switch out hardware cloth with chicken wire towards the top of the coop and above the height of the chickens since predators cannot reach chickens at higher heights
  
    - What if we do suggestions for each kind of predator situation?
  - Weather
    - At least 95% of major winds and storms come from the west, so be sure to make one side of the coop stronger to protect from strong winds



## Designing a Mobile Chicken Coop

- If coop is going to be used year round, make sure it can withstand the winter load and have proper ventilation during hot summer days
- Corners and Joints:
  - For smaller/younger birds, coops must have rounded corners to prevent birds from smothering each other in cold temperatures
  - Corners need bracing
  - Joints and seams tend to drip water, so it is better to waterproof them and definitely do not put feed under them
- In General,
  - Hoop style roofing would be good for our design
    - Can be made out of PVC, though PVC can't handle a winter load.
      - Use steel instead, but that would add weight
    - The size of the roof and coop itself would be limited by the size of the cattle panel
  - Use stainless steel screws instead of drywall because drywall tend to rust
  - UV rays can tear plastic apart and disintegrate it, so make sure the plastic has some sort of UV protection
  - A coop made entirely of PVC piping would be way too light and could not stand up against the wind
  - Pam can do pro/con critiques for us.
  - We need to decide what kind of bird we are building for.
  - Their movable coop is only for the night time and can hold 75 birds thanks to the staggered roosts. They have a 40'x40' movable pen they set up around it.

### A.3 Notes from Interview with Jassy Bracko

- A wooden base with a PVC piping hoop works well and does not get blown away
- Retractable wheels would be the ideal
- It would be helpful to have a way to help the birds learn to move with the coop. Meat birds take about a week to learn and can get left behind when the coop is being moved.

## Designing a Mobile Chicken Coop

- If the wheels used are too small and the ground is uneven the coop will be very difficult to move
- If the wheels are too big then the birds can slip out under the gap
- Chicken tractors are useful since you don't need to clean a floor of a coop and the birds fertilize the field they are being moved over
- It is hard to herd chickens into a coop, but at dusk chickens will go in by themselves
  - If you let chickens roam during the day you run the risk of not being there right after the sun sets to shut them in and that makes them vulnerable to predators
- Jassy has made the farm fit her lifestyle ,not the other way around so she can cut everything that doesn't have to be done
- Meat birds need to be moved more often due to the mess they make
- Automation would be a great idea and possibly a way to expand on this topic in the future

## Appendix B: Pros and Cons of Different Materials

Materials	Pros	Cons
<b>Untreated Wood</b>	<ul style="list-style-type: none"> <li>• Easy to build with</li> <li>• Sturdy and Strong</li> <li>• Cheap</li> <li>• Easily found in home improvement stores</li> </ul>	<ul style="list-style-type: none"> <li>• Heavy</li> <li>• Because wood is untreated, it will rot easily</li> <li>• Large amounts of upkeep and maintenance</li> </ul>
<b>PVC Piping</b>	<ul style="list-style-type: none"> <li>• Very inexpensive</li> <li>• Very light</li> <li>• Easy to assemble</li> </ul>	<ul style="list-style-type: none"> <li>• Some have lead-based stabilizers, which have the potential to contaminate the ground</li> <li>• Not very strong- cannot withstand attacks from large predators or extreme weather exposure such as high wind speeds</li> </ul>
<b>Aluminum Piping</b>	<ul style="list-style-type: none"> <li>• Superior Structural Integrity</li> <li>• Durable- can withstand many types of weather and negative exposure</li> </ul>	<ul style="list-style-type: none"> <li>• Expensive</li> <li>• Tough to find in home improvement stores</li> <li>• Very heavy- will be hard to lift and move</li> </ul>

# Designing a Mobile Chicken Coop

## Appendix C: Original Design Sketches

Hoop Coop:

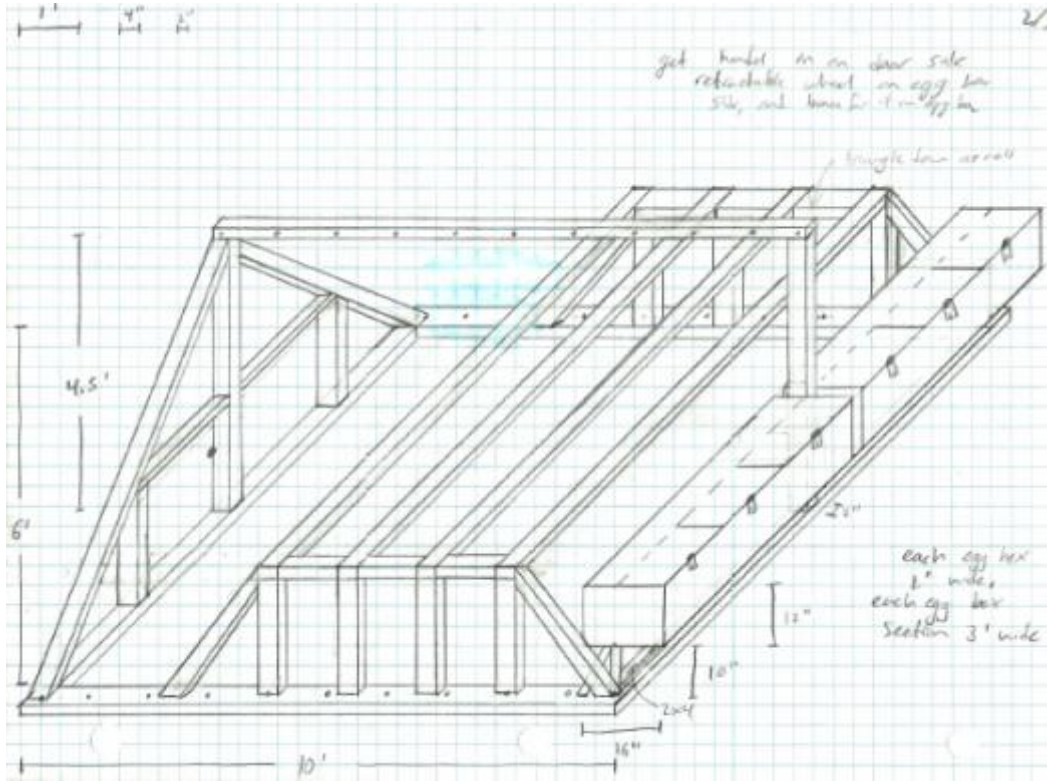

Figure 79: Hoop Coop First Sketch Full View

# Designing a Mobile Chicken Coop

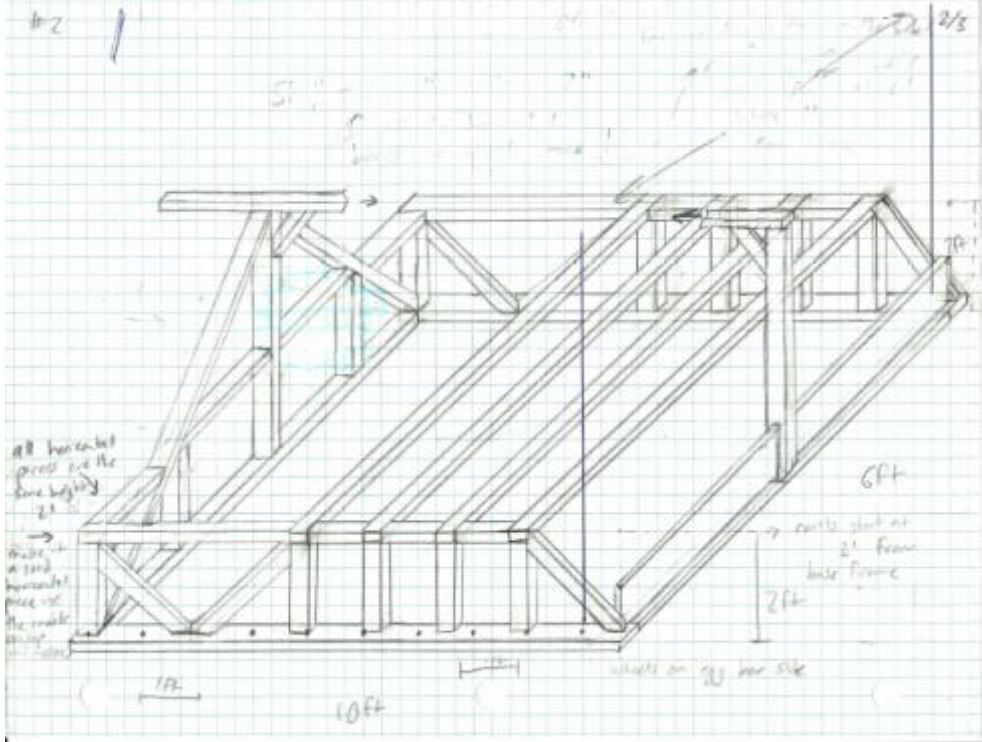

Figure 80: Hoop Coop Final Sketch Full View

# Designing a Mobile Chicken Coop

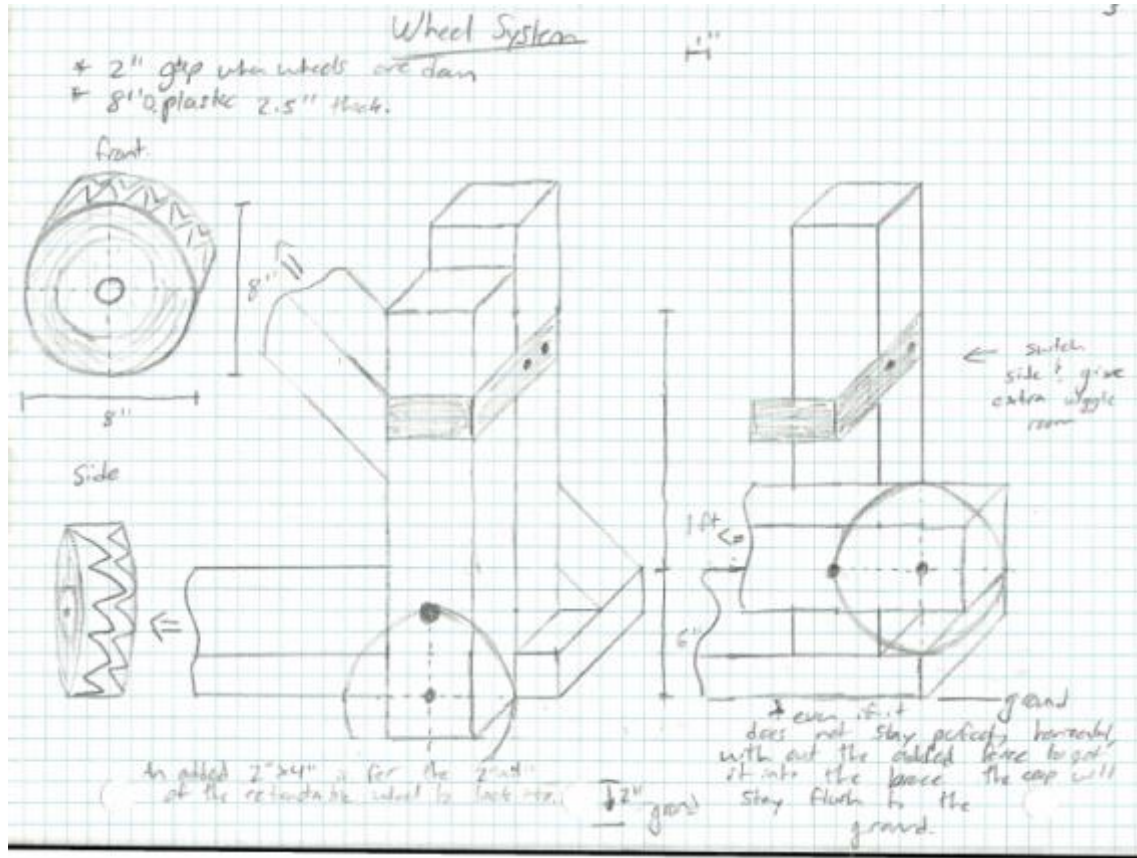

Figure 81: Wheel System Sketch

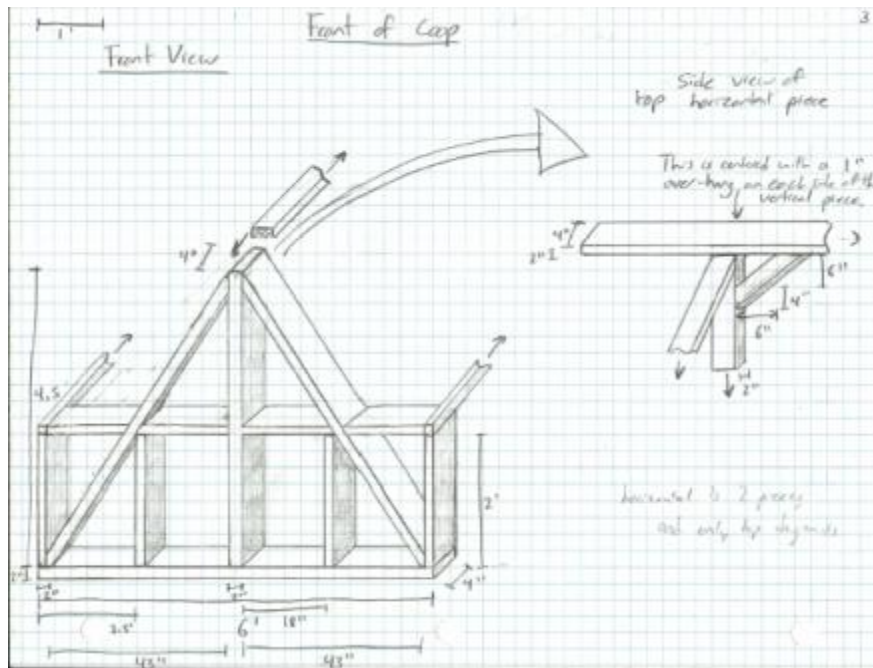

Figure 82: Hoop Coop Sketch Front View



# Designing a Mobile Chicken Coop

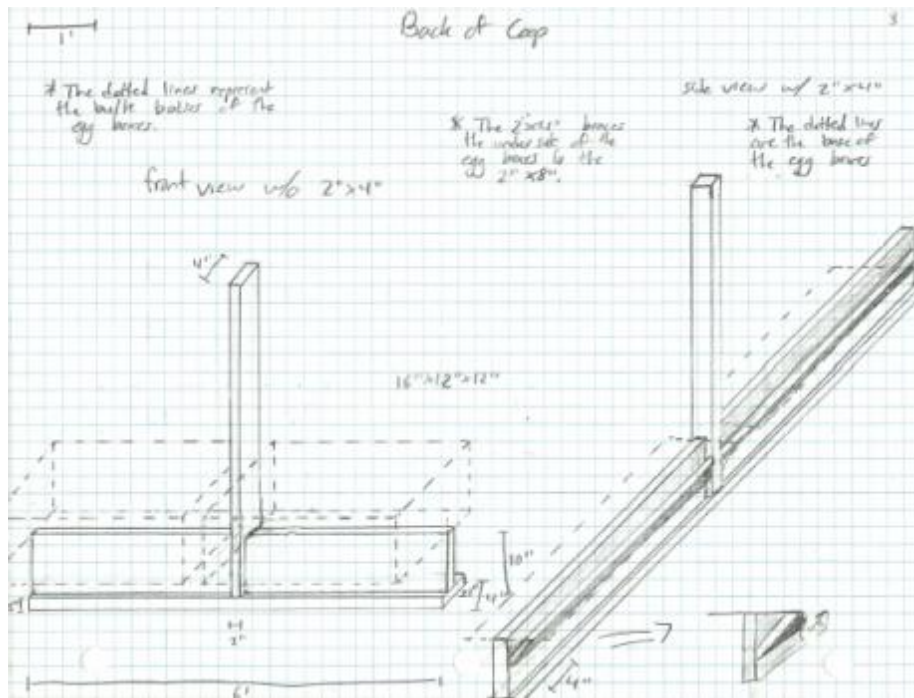

Figure 83: Hoop Coop Sketch Back View

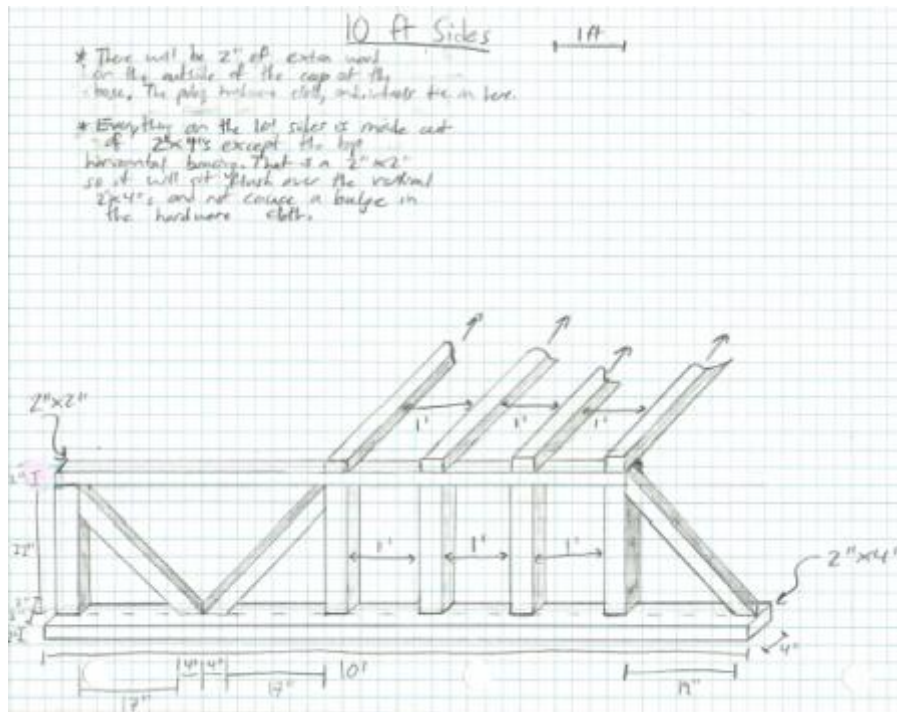

Figure 84: Hoop Coop Sketch Side View

# Designing a Mobile Chicken Coop

## Hybrid Hoop Coop:

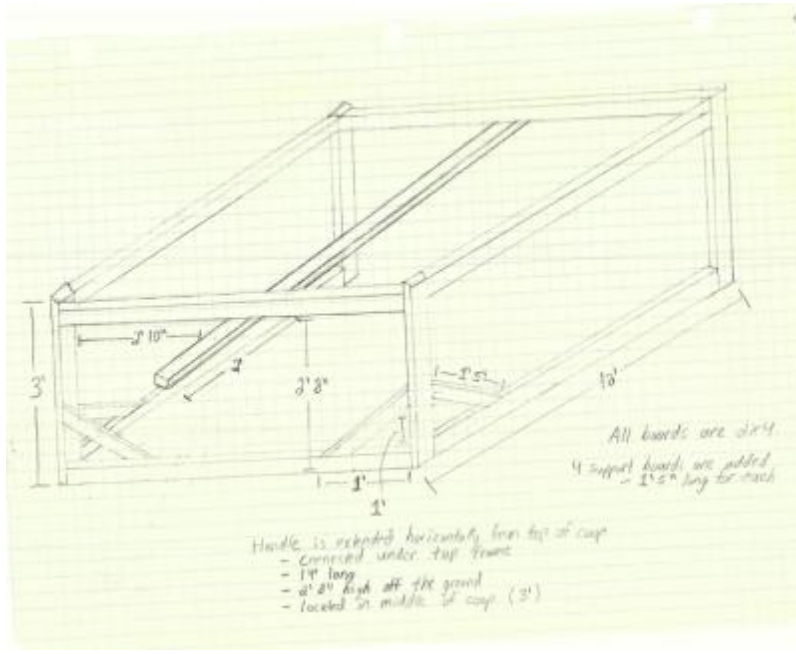

Figure 85: Hybrid Hoop Coop Sketch Roost

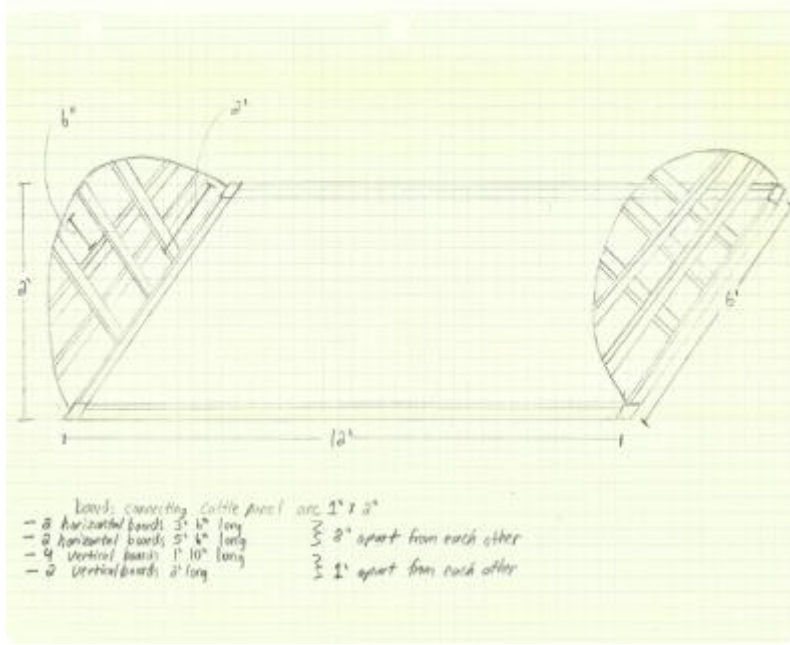

Figure 86: Hybrid Hoop Coop Sketch Top

# Designing a Mobile Chicken Coop

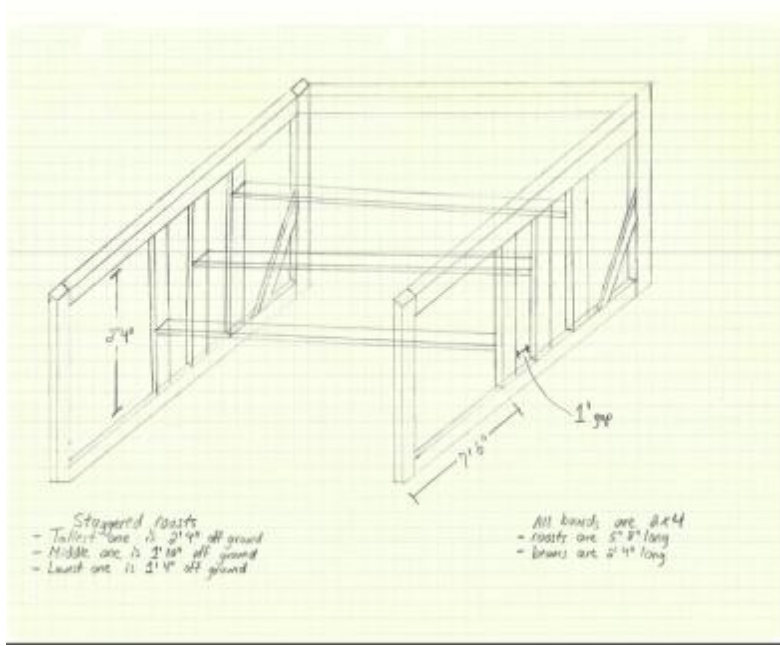

Figure 87: Hybrid Hoop Coop Sketch Staggered Roosts

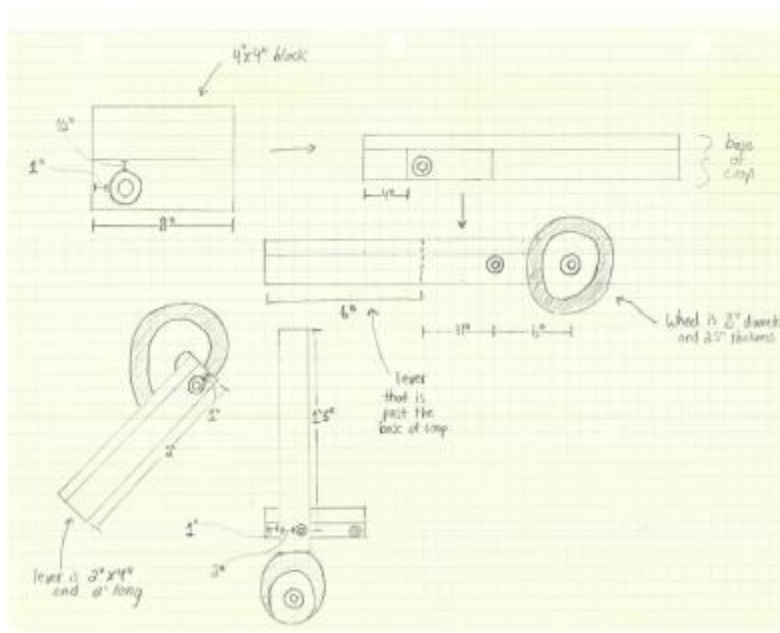

Figure 88: Hybrid Hoop Coop Sketch Wheel System

## Designing a Mobile Chicken Coop

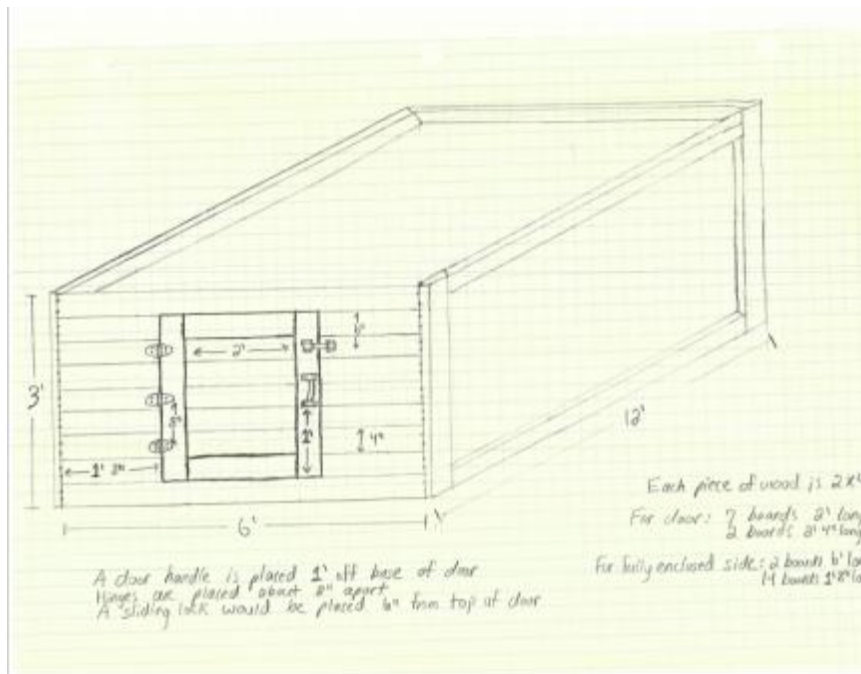

Figure 89: Hybrid Hoop Coop Sketch Door

Fully Enclosed Coop:



# Designing a Mobile Chicken Coop

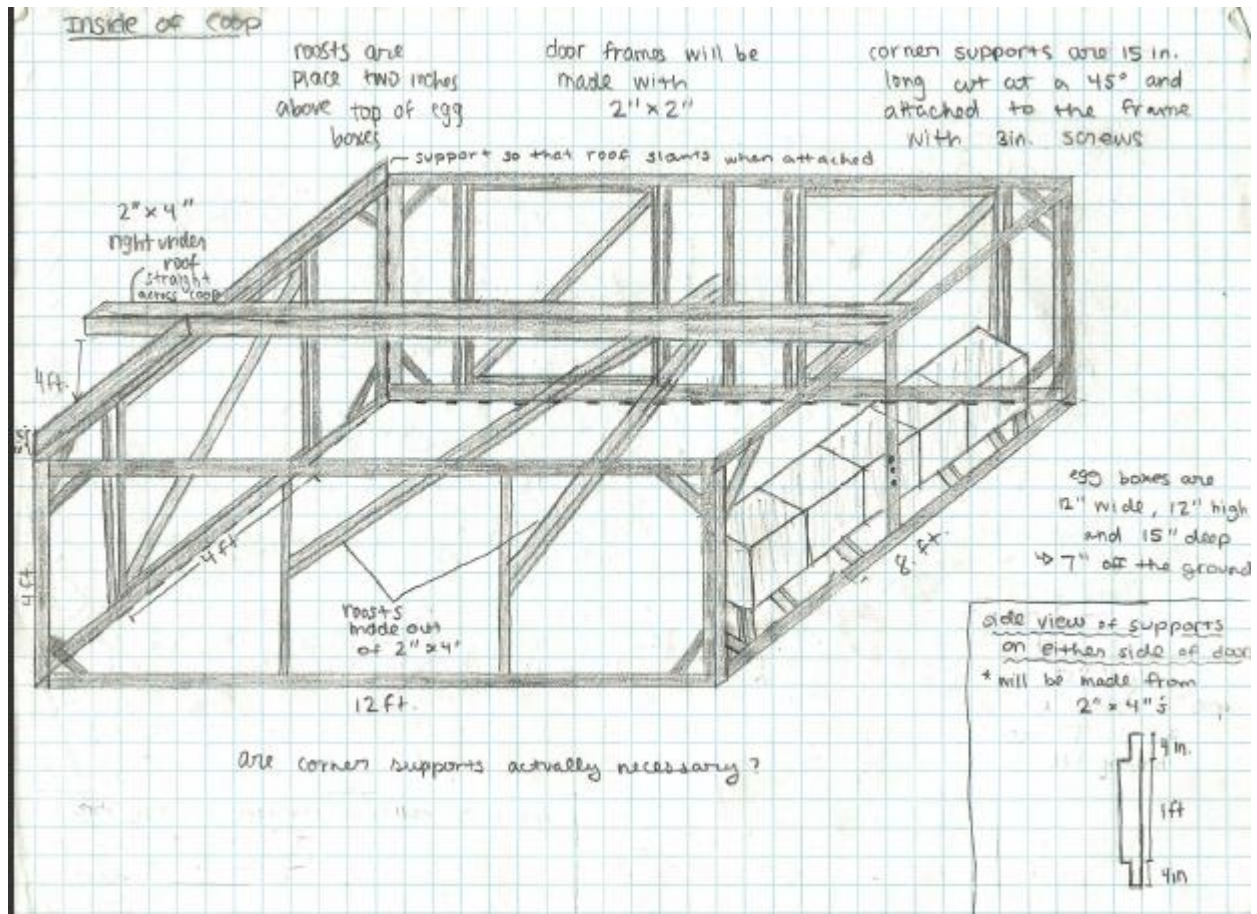

Figure 90: Fully Enclosed Coop Sketch

Designing a Mobile Chicken Coop

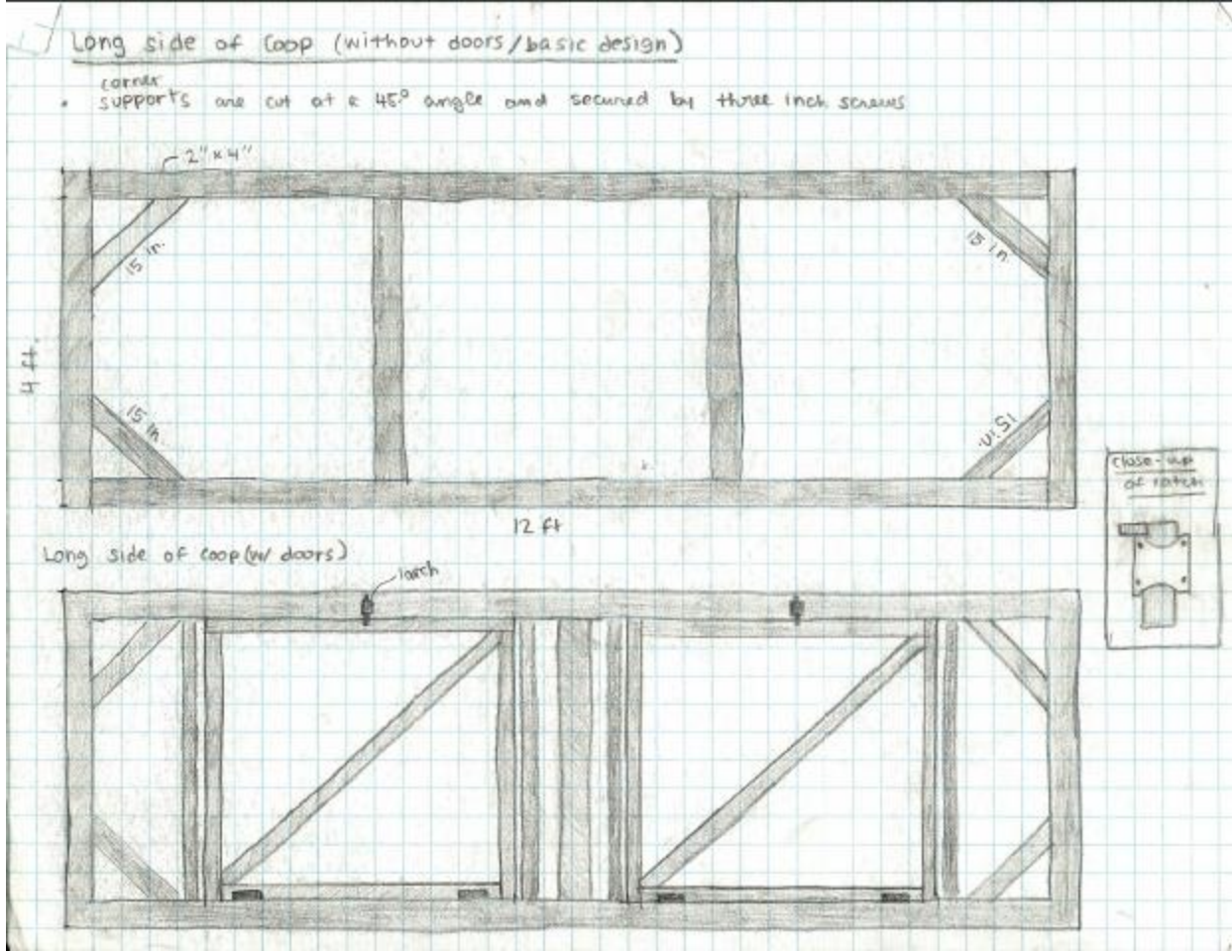

Figure 91: Fully Enclosed Coop Sketch Sides



# Designing a Mobile Chicken Coop

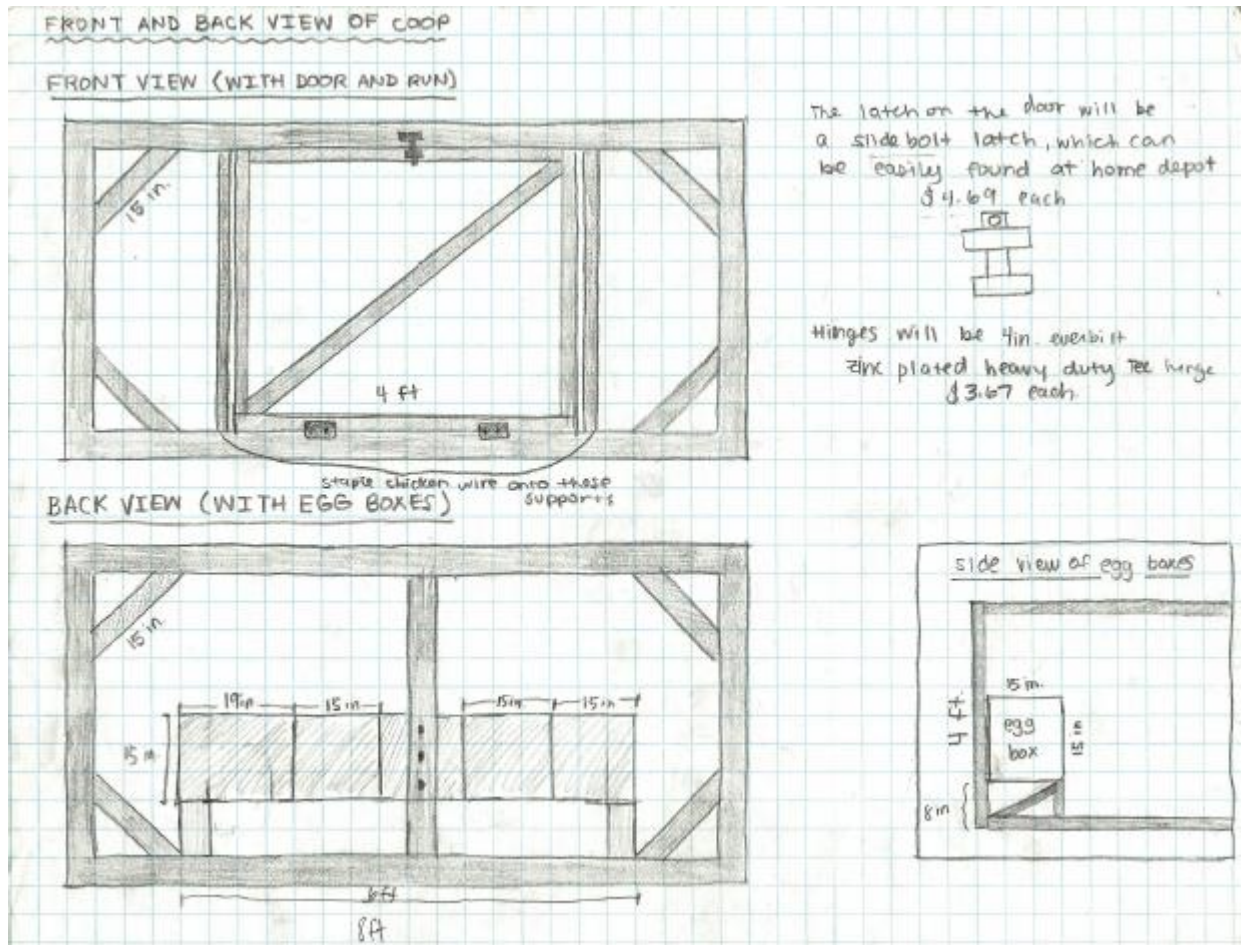

Figure 92: Fully Enclosed Coop Sketch Front and Rear View

# Designing a Mobile Chicken Coop

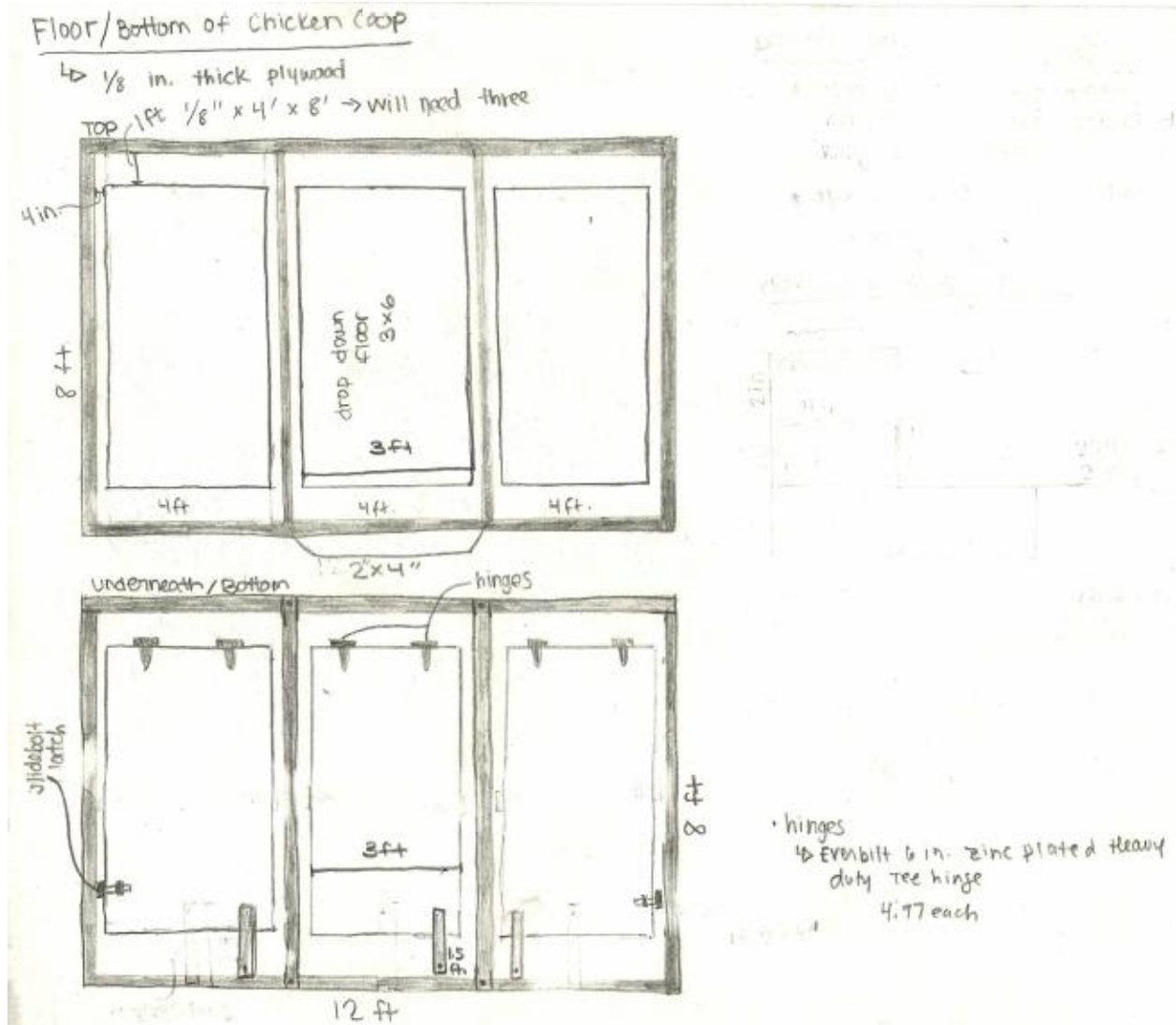
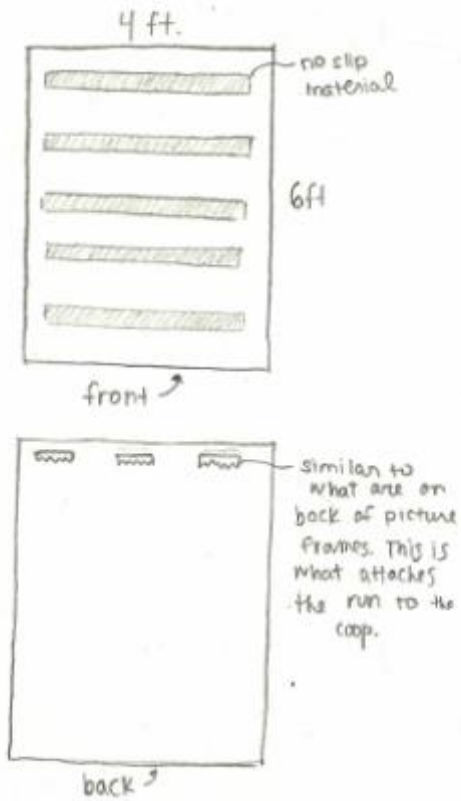

Figure 93: Fully Enclosed Coop Sketch Bottom

# Designing a Mobile Chicken Coop

## Attachable Run

↳ made of thin plywood



Roofing → there are many diff options for roofing. For the prototype coop, I just used a piece of sheet metal that spanned the entire coop and was put at a slight slant to repel water.

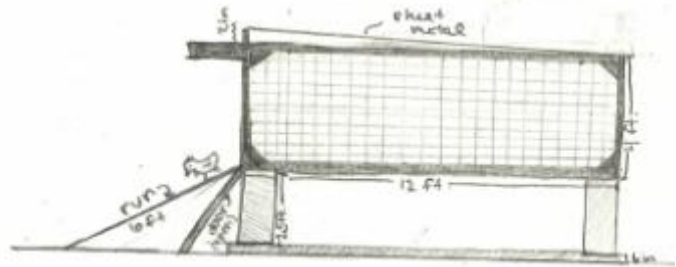

Figure 94: Fully Enclosed Coop Movement System