

IMPACT OF HYBRID CARS

An Interactive Qualifying Project Report  
submitted to the Faculty of  
WORCESTER POLYTECHNIC INSTITUTE  
in partial fulfillment of the requirements for the  
Degree of Bachelor of Science  
by

Laura Friedman

Date: May 1, 2010

Professor Eben C. Cobb, Advisor

## **Abstract**

The topic of this research paper is the impact of hybrid electric vehicles (HEVs) on the environment and society. The methodologies used to carry out research on this topic include collecting information on HEVs, their components, pollution caused by the manufacturing of their batteries, their economics, and their safety. The conclusions of the report are that HEVs adversely impact the environment and society.

## Table of Contents

Abstract .....	ii
Table of Contents .....	iii
Table of Figures .....	vi
Introduction.....	1
1. Definition of the Problem .....	6
1.1 Fossil Fuels.....	6
1.2 Air Pollution.....	7
1.2.1 Particulate Matter .....	8
1.2.2 Carbon Monoxide.....	9
1.2.3 Unburned HC's.....	9
1.2.4 Nitrogen Oxides.....	10
1.3 Global Warming.....	11
1.4 Rate of Oil Production.....	11
1.5 Oil Reserves .....	12
1.6 Demands for Oil.....	13
2. How Hybrid Electric Vehicles Work.....	15
2.1 Why the name, Hybrid? .....	15
2.2 Power Train Configurations .....	15
2.3 Function of Main HEV Components .....	17
2.3.1 Transaxle Assembly .....	18
2.3.2 Hybrid Vehicle Computer Control .....	18
2.3.3 Inverter and Converter Assembly.....	19
2.4 HEV Operation.....	20
2.5 Popular Hybrids on the Road Today .....	21
3. The Batteries Used in Hybrid Electric Vehicles .....	23
3.1 What is a Battery? .....	23
3.2 Electrochemistry of Batteries Used in HEV Applications .....	24
3.2.1 Battery Terminology.....	24
3.2.2 Electrochemistry of Voltaic Cells.....	27

3.3 Types of Batteries.....	27
3.3.1 Lead-Acid Batteries .....	28
3.3.2 Nickel-Metal Hydride Batteries.....	29
3.3.3 Lithium-Ion Batteries .....	31
3.4 Manufacturing Batteries .....	32
3.4.2 The Manufacturing of the Nickel Metal Hydride Battery .....	32
3.4.3 Constructing a Lithium Ion Battery .....	34
3.5 Battery Safety .....	35
3.6 Recycling Batteries .....	35
3.7 Pollution Caused by Batteries .....	37
3.7.1 Nickel Mining.....	37
4. Regenerative Braking and its Importance in an HEV.....	44
4.1 Brakes, Wheels, and Tires.....	45
4.1.1 Slip.....	45
4.1.2 Tire Forces .....	45
4.2 Energy Recovered From Regenerative Braking.....	47
4.3 Importance of Regenerative Braking to an HEV .....	48
4.4 Combining Friction Braking with Electric Regenerative Braking.....	50
5. Economics of Hybrid Electric Vehicles.....	52
5.1 Owning an HEV .....	52
5.1.1 Taxes.....	52
5.1.2 Example Purchase of a Hybrid Electric Vehicle .....	54
5.1.3 Fuel Savings .....	55
5.1.3 Insurance.....	56
5.1.4 Depreciation.....	57
6. Hybrid Vehicle Safety.....	58
6.1 High Voltage HEV components.....	58
6.2 Safety Features and Emergency Response Procedures .....	60
7. Other Alternatives .....	61
7.1 Clean Diesel TDI.....	61

Conclusions.....	63
References.....	67
Appendix A.....	70

## Table of Figures

Figure 1: Pollutant Formation in the Four ICE Cycle Phases (Heywood) .....	8
Figure 2: National Carbon Monoxide Emissions by Source Sector in 2005 (www.epa.gov) .....	9
Figure 3: Hubbert’s Curve ( <a href="http://yalibnan.com/site/">http://yalibnan.com/site/</a> ).....	12
Figure 4: Percent Oil Consumption by Country (www.nationmaster.com) .....	13
Figure 5: Schematic of Parallel HEV (Riley) .....	16
Figure 6: Schematic of Series HEV (Riley).....	17
Figure 7: DC-DC Converter (Northborough) .....	20
Figure 8: Inverter-2010 Lexus HS250h (Northborough).....	20
Figure 9: LCD Display (left) and Instrument Panel (right) from Lexus HS250h (Northborough) .....	21
Figure 10: Voltage for Ideal Battery vs. Depth of Discharge .....	25
Figure 11: Depth-of-Discharge vs. Cycle Life (www.surette.com).....	26
Figure 12: Inside a 12 V Lead-Acid Battery (Deconstructed: How Car Batteries Work).....	29
Figure 13: GM Ovonic 90 Ah Prismatic Cell and 13 V Module (Linden) .....	33
Figure 14: Example of Cylindrical Cell Design (www.cleanmpg.com).....	33
Figure 15: Nickel Flash Smelting (www.outotec.com) .....	39
Figure 16: SO <sub>2</sub> from Norilsk, Russia Nickel Mine ( <a href="http://earthobservatory.nasa.gov">http://earthobservatory.nasa.gov</a> ).....	41
Figure 17: Mudslides near Nickel Mining Plant in Indonesia (The Impact of a Nickel Mine in Tanjung Buli, Indonesia) .....	42
Figure 18: Suspended Sediments on Coast of Nickel Mine (The Impact of a Nickel Mine in Tanjung Buli, Indonesia) .....	42
Figure 19: Oil Slicks Near Nickel Mine in Indonesia (The Impact of a Nickel Mine in Tanjung Buli, Indonesia).....	43
Figure 20: Table of Symbols for Regenerative Braking Equations .....	44
Figure 21: Friction Coefficient vs. Slip Percentage (Fuhs) .....	46
Figure 22: Slip Angle (Haney).....	47
Figure 23: Using P/m Ratio to Determine Stopping Distance at a Given Velocity (Fuhs) .....	49
Figure 24: Braking Forces acting on Vehicle (Ehsani, Gao and Emadi).....	49
Figure 25: Control Logic for Brake Forces (Ehsani, Gao and Emadi) .....	51
Figure 26: Table Comparing 2008 Honda Civic to its Hybrid Counterpart .....	54

Figure 27: Table of Battery Pack Voltages in Various HEVs ..... 58  
Figure 28: Vents for Battery Pack in Rear Seats of Lexus Model HEV (Northborough) ..... 59  
Figure 29: Battery Pack in Toyota Prius (left) and Lexus RX400h (right) (Toyota Motor Sales) 59

## Introduction

The automobile industry is weakening due to the current recession in America. However, car owners, manufacturers, and dealers across the world know that the automobile is an essential part of society. There are millions of cars on the road in the world today, and their inefficiencies are harming the environment and costing the planet its natural resources. The internal combustion engine (ICE) has been used as a means of propulsion for decades. However, it is inefficient, and its byproducts are causing harm to the environment. Issues such as global warming, air quality, unburned hydrocarbons being released into the atmosphere, and the diminishing reserves of oil are all raising concerns and instigating a need for a more efficient means of transportation.

Automotive engineers have been designing vehicles for maximum fuel efficiency. However, the internal combustion engine has limited efficiency. Design engineers have introduced several alternatives, including the hybrid electric vehicle (HEV), the use of biodiesel fuel in ICEs, fuel cell technology and purely electric vehicles. The HEV is a relatively old concept but a new technology that is slowly being made available to consumers. The HEV is intended to serve as an alternative to the internal combustion engine powered vehicle, with the hope that the HEV is more efficient and therefore less harmful to the environment. Ultimately, the HEV should start to solve the environmental problems that the present ICE vehicles cannot solve without introducing any equally harmful effects.

There are two main goals of this paper. The first goal is to explain what an HEV is, how it works, and how it is made. The second is to use the information collected from the first goal and draw a conclusion as to whether or not HEVs benefit the environment and society from an engineering point of view.



The first section defines the problems at hand and goes into further detail on why the need for HEVs has developed. Explanations of what fossil fuels are and how oil is used to make petroleum are included. This section also explains oil reserves and how oil is extracted from the ground. Oil is a naturally occurring resource that cannot be replenished quickly enough to be useful. Achieving the maximum possible miles per gallon (mpg) rating is becoming a top priority for automotive engineers because of the economic impact of this reality. This section's purpose is to give the reader an understanding of the problems with our sources of oil and the inspiration behind the HEV.

Air pollution is another major factor in the problems facing the ICE, which is also discussed in the first section. The exhaust gas from an ICE contains many chemicals that attribute to the much of the air pollution on the planet. Smog, global warming, depletion of the ozone layer and acid rain are all serious matters harmfully affecting the sustainability of the planet's ecosystem. Chemicals such as carbon monoxide (CO), carbon dioxide (CO<sub>2</sub>), unburned hydrocarbons (HCs), and nitrogen oxides (NO<sub>x</sub>) are released into the atmosphere from ICEs, and they contribute to the aforementioned types of air pollution. HEVs attempt to reduce the emissions of these harmful chemicals by reducing the use of the ICE in an automobile.

The following section dives into the nuts and bolts of how a hybrid works. There are explanations of the different drive train configurations for an HEV, such as parallel, series, and plug-in. The relationships among the small ICE, the electric motor/generator (M/G), and the battery pack are different in each of the configurations, and it is essential to be familiar with these relationships to truly understand how HEVs work. There are various systems in an HEV that work in conjunction to propel the vehicle, and they are explained in detail. The HEV also has components that ICE vehicles do not have. This section, discussing how hybrids work,

defines for the reader the engineering and technology behind HEVs. In order to understand the impact of hybrid vehicles, one must understand the principles of how they work and all of the components that an HEV comprises.

The battery pack is an essential component of an HEV, and it is important to understand its complexity. A detailed discussion of the battery pack is important as it is a large source of the HEVs impact on the environment. This section describes the electrochemistry of a rechargeable battery. It also describes the different types of batteries used in HEVs today, such as nickel-metal hydride (NiMH) and lithium ion (Li-ion). The impact that the chemicals have on the environment is also analyzed, as well as the impact of the manufacturing, disposal, and recycling of batteries.

One of the technological features that permit an HEV to achieve superior mpg ratings is regenerative braking. The next section discusses the mechanics of regenerative braking and its effectiveness. Regenerative braking uses the kinetic energy that is usually lost when braking in today's vehicles. The idea is that the M/G in the HEV works in reverse to slow down the car. While doing so, the M/G acts as an electric generator to recharge the battery pack. This is essential to the efficiency of an HEV, because it reduces overall energy losses in the vehicle.

An important factor to consider while discussing the impact of HEVs on society is the economics of HEVs. The cost of producing a hybrid vehicle is much higher than the cost of producing a non-hybrid. That in turn makes HEVs more expensive for consumers. For example, the Manufacturer's Suggested Retail Price (MSRP) of a Honda Civic Hybrid Sedan is \$23,800 compared to the MSRP of the base model Honda Civic which is \$15,665. The price difference is called a price premium and is added to the cost of all HEVs. Hybrids require extra components

that ICE cars don't need, such as the extra batteries. This section also takes a look into what it costs to maintain a hybrid, and what it would cost to replace dead batteries.

The fourth section briefly covers the safety of HEVs. There are components of an HEV that make its safety different from that of an ICE car. HEVs must be handled differently due to their high voltage components, such as the battery pack and the circuits. How an HEV performs in a collision compared to a regular ICE car is also discussed.

The concluding segments of the paper discuss other alternative technologies for the HEV to the ICE. These alternative technologies are briefly mentioned to serve as suggested topics for readers to research on their own. The future of hybrid vehicles and automobiles in general is discussed. It is important to ponder what is in store for the future and where hybrid cars will stand in the world of automobiles.

This paper serves to be informational, eye-opening, and thorough. It seeks to demonstrate that in order to have an accounting on the environmental impact of HEVs, one must be aware of every aspect of the environment and society that they affect. Arguing that the HEV is the solution to all of the problems mentioned in this introduction solely because of its superior gas mileage ratings is not sufficient. One must look at the effect of HEVs on society and the environment on a larger scale. Just as dropping a stone into a body of water creates ripples, the creation and distribution of an HEV has this same "ripple effect". HEVs have a ripple effect and these effects are important to analyze. To arrive at a conclusion on whether or not HEVs will or will not be beneficial, the chain reaction of environmental impacts HEVs have must be observed.

After extensive and thorough research on the impacts of HEVs on the environment and society, it is concluded that HEVs are not beneficial in the ways that they are claimed to be. HEVs are being implemented to reduce as much air pollution as possible and lessen the

consumption of oil, but they are proved to be inadequately accomplishing this task with the information presented in this research paper. The environment is being adversely effected by HEVs because the air pollution that comes from the manufacturing of the battery packs used in them. Section 3 includes a detailed discussion on this matter with supporting calculations. It is also false to assume that the cost of the HEV price premium can be replenished with the saved money from the high MPG rating. In section 5 there's information on the total cost of owning an HEV for its lifetime.

It is important for prospective car buyers to make an educated decision on whether to buy a hybrid, because that decision will have an effect on the environment and society. This paper seeks to educate the reader in what the environmental and societal impacts of HEVs are, allowing the reader to weight those factors in a decision on whether to purchase an HEV.

## **1. Definition of the Problem**

One may ask the question, “Why is there a need for a new automobile design?” or “Why is there all this fuss about hybrids?” There are a multitude of reasons for the increasing popularity of hybrid electric vehicles (HEV) across the world. Issues such as air pollution, global warming, and harmful toxins released in the exhaust of an internal combustion engine (ICE) all contribute to this need. Other matters in consideration are the estimated production of oil, where oil reserves stand today, and the depletion of petroleum. Gasoline accounts for nearly 20 percent of every barrel of crude oil produced. Gasoline requires two times the amount of oil to produce than any other product that’s refined from crude oil. It is necessary to find a more efficient way to use the existing resources that we have on the planet. One of the most important reasons HEVs are being developed is because of the magnitude of oil used to make the gasoline that propels the ICE automobiles of today.

### **1.1 Fossil Fuels**

The chemical that is refined to produce gasoline is called petroleum, a naturally occurring crude oil found underneath the Earth’s surface. This makes gasoline a fossil fuel. Crude oil is a result of decomposing matter below the earth’s crust that is subjected to high pressures. This process of decomposition takes millions of years. When an oil reservoir is found, an oil rig is set up to drill an oil well, which can reach a depth of up to 6 miles. Material separated from the original crude oil is sent to oil refineries where petroleum refining takes place. Depending on the grade of the gasoline and its octane, the amount of each component in the mixture varies. More importantly, however, petroleum consists mostly of hydrocarbons (HCs). It is the combustion of these HCs that are causing harm to the environment. The harmful byproducts released by the combustion reaction in an ICE consist of nitrogen oxides (NO<sub>x</sub>), carbon monoxide (CO), carbon

dioxide ( $\text{CO}_2$ ), and unburned HCs. The only non-harmful compound produced from the exhaust is water ( $\text{H}_2\text{O}$ ).

## 1.2 Air Pollution

There are various sources of air pollution on Earth, such as industrial power plants and furnaces, businesses, households, and transportation. In this section we will focus on air pollution from the ICE, which is one affect that HEVs aim to minimize. ICE cars are accountable for a large amount of air pollution, but not for all types of air pollution. The categories of air pollution include carcinogens, acid rain, global warming, smog, and ozone depletion. Certain chemicals from an ICE's exhaust are sources for these types of pollution, such as  $\text{CO}$ ,  $\text{CO}_2$ , ( $\text{NO}_x$ ), particulate matter, and unburned HCs.

The formation of these chemicals occurs in the different phases of the ICE's cycle, which are compression, combustion, expansion, and exhaust. The most important sources are, of course, those produced in combustion and vented through the exhaust pipe. These exhaust gases consist mainly of unburned HCs,  $\text{CO}$ , and  $\text{NO}_x$  and account for approximately 90-92% of all motor vehicle emissions (Godish). During compression and combustion, a small fraction of the fuel-air mixture gets forced into the area between the piston and the cylinder wall. This portion of the fuel-air mixture is left unburned and is later expelled into the air during the expansion and exhaust phases.  $\text{CO}$  forms when there are not enough oxygen atoms to turn all the carbon in the fuel-air mixture into  $\text{CO}_2$ .  $\text{NO}_x$  forms during the combustion process and the higher the temperature of the combustion chamber the higher the formation of  $\text{NO}_x$ . A diagram of the four phases of an ICE and where the unburned HCs, the  $\text{NO}_x$ , and  $\text{CO}$  for each is shown in figure 1 on the next page.

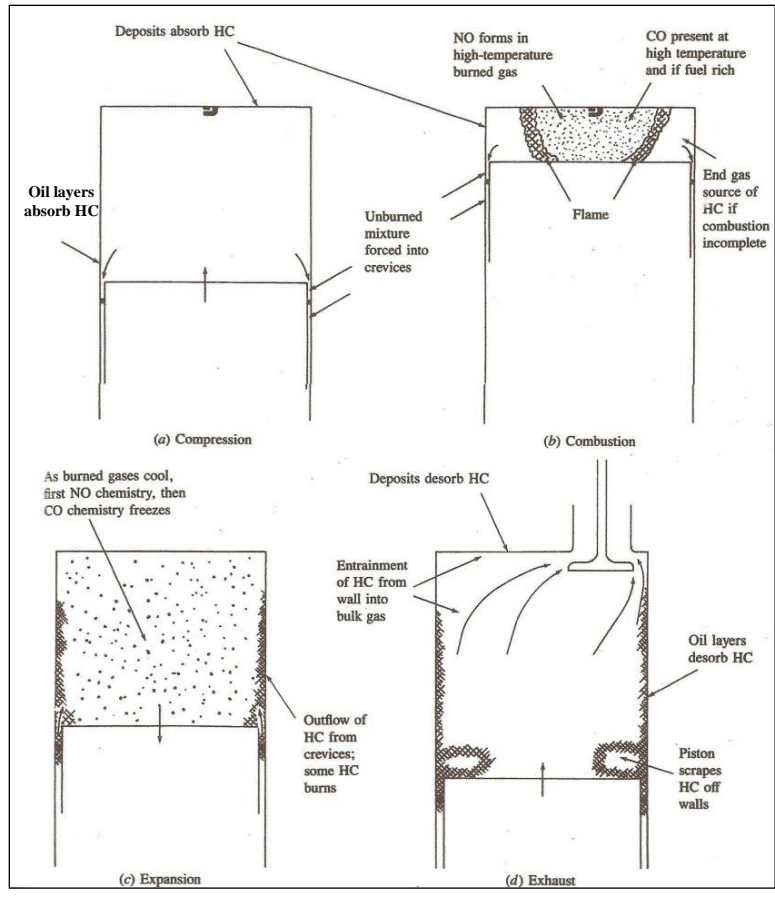

**Figure 1: Pollutant Formation in the Four ICE Cycle Phases (Heywood)**

**1.2.1 Particulate Matter**

When an ICE is running, some of the fuel-air mixture does not get combusted. By-products of this incomplete combustion include carcinogenic chemicals such as particulates and benzene. Particulates, or particulate matter, are liquid droplets suspended in the air from pollution. Examples of particulates include sulfates, nitrates, dust, metal, and organic chemicals. Soot, clusters of carbon spheres, is another particulate. Carbon spheres are generated in the combustion chamber in the fuel-rich zones where there is not enough oxygen to convert all carbon to carbon dioxide (Pulkrabek). Particulate matter is also a large contributor to ground-level ozone. Ground-level ozone is formed when vehicle emissions containing volatile organic compounds (particulates) interact in the presence of sunlight. Therefore, some of the sunniest

cities are also some of the most polluted (Oblack). Ground level ozone can also be permanently damaging to the lungs and the heart. People with respiratory problems are more affected by this.

### 1.2.2 Carbon Monoxide

Carbon Monoxide is another harmful toxin to humans and animals. The exhaust from ICEs is the most common source of carbon monoxide (as observed from figure 2 below). It is released into the atmosphere when there is not enough oxygen in the combustion process. Carbon monoxide emissions from an ICE depend on the fuel-air mixture going into the combustion chamber. The richer the fuel, the percent volume of CO increases. Prolonged exposure to high concentrations of carbon monoxide can lead to brain damage and/or death. When carbon monoxide gets into the blood cells, it prevents oxygen from binding to hemoglobin.

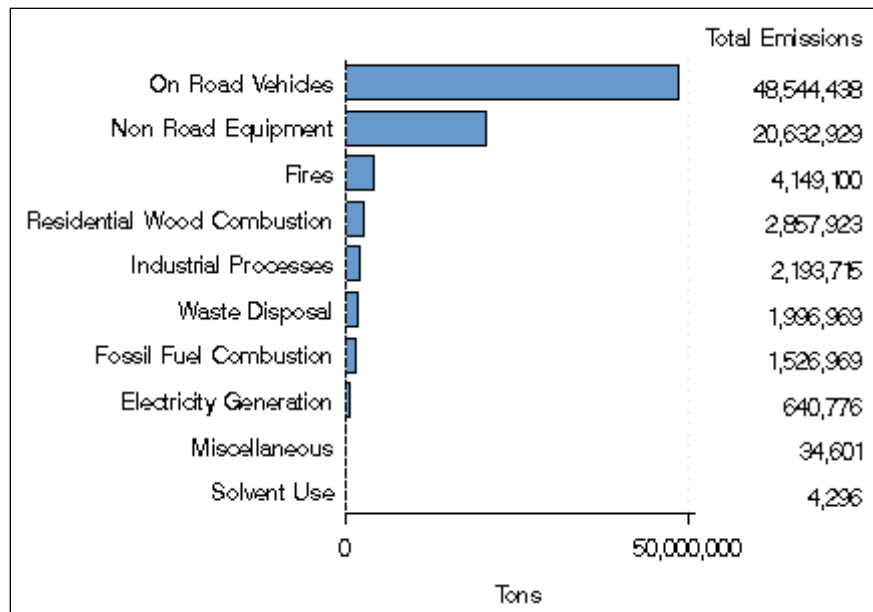

Figure 2: National Carbon Monoxide Emissions by Source Sector in 2005 ([www.epa.gov](http://www.epa.gov))

### 1.2.3 Unburned HC's

Unburned HCs are the result of the unburned fuel-air mixture getting caught in the crevices between the piston and the cylinder wall (as shown in figure 1). During the combustion



process, unburned HCs are oxidized producing carcinogens such as formaldehyde and alkenes. Another effect of unburned hydrocarbons is smog. Smog is a type of air pollution that is typically manifested by high concentrations of ground-level ozone. Ozone is a molecule formed of three oxygen atoms, and it is dangerous for attacking the membranes of living cells (Ehsani, Gao and Emadi).

#### **1.2.4 Nitrogen Oxides**

Nitrogen oxides are another category of harmful chemicals released from an ICEs exhaust. Nitrous oxide ( $\text{N}_2\text{O}$ ), commonly used at the dentist's office as an anesthetic, is a greenhouse gas. This gas absorbs infrared radiation and emits it back into the atmosphere. This creates the greenhouse effect, which causes the temperature of the earth's surface to rise. Another nitrogen oxide present is nitric oxide. The catalytic converters used on ICEs today try to minimize the release of this pollutant by using a catalyst to oxidize the  $\text{NO}_x$ . Nitric oxide can only be produced at extremely high temperatures, which is the exact environment of the combustion chamber in an ICE. High concentrations of nitric oxide gas may cause an oxygen-deficient atmosphere; however, other more significant health effects will occur prior to those for oxygen deficiency.

Of all the nitrous oxides, nitrogen dioxide ( $\text{NO}_2$ ) is the most prevalent. At certain temperatures, nitric acid can produce nitrogen dioxide. Although sources of  $\text{NO}_2$  can be found in kerosene heaters and un-vented gas stoves and heaters, ICEs are the largest source of nitrogen dioxide production.  $\text{NO}_2$  also adversely affects the lungs. Prolonged exposure to high concentrations of this gas can lead to pulmonary edema.

### **1.3 Global Warming**

Global warming is the result of greenhouse gases accumulating from air pollution. One of the most common greenhouse gases is carbon dioxide, which is released from the ICE.

Disrupting the temperature of the earth has ill affects because climate changes can ensue. The polar ice caps are melting due to the temperature rise, and this causes the sea levels to rise.

Constant raining and flooding in some regions have been linked to this.

Global warming can also be associated with the loss of some endangered species. The change in climate causes some species to move to a region with a lower temperature where they might destroy a species native to that area.

### **1.4 Rate of Oil Production**

Petroleum is a non-renewable resource. The oil reserves on the planet are being depleting while the demand for oil is rising. This reality is becoming more and more prevalent as the cost of gasoline rises. The economy is already suffering from the effects of the relationship between oil production and demand for oil being so unbalanced. The rate of retrieving oil from the ground can never increase, and this rate will decrease over time (Fuhs). Eventually, the demand for oil will become so high that the supply on Earth will no longer satisfy it.

Ideally, oil would be refined and turned into gasoline faster than it is consumed. Anything that could slow down the consumption of oil products would help to reach this goal, such as alternate energy sources. Inevitably, oil production will diminish to nothing. However, it is the time it takes to get to that point that must be delayed as long as possible.

The rate of oil production can be represented graphically on a bell curve. Oil production can also be predicted using this graph and data from the billions of barrels of oil produced since oil production began in 1900. Dr. M. King Hubbert, a geophysicist from the early 1900s, is most

famous for predicting the peak of oil production in the world. His prediction in 1956 that U.S. oil production would peak in about 1970 and decline thereafter was scoffed at then but his analysis has since proved to be remarkably accurate (Ehsani, Gao and Emadi). The bell curve graph to represent the rate of oil production is now known as the ‘Hubbert Curve’ and is shown in figure 3 below.

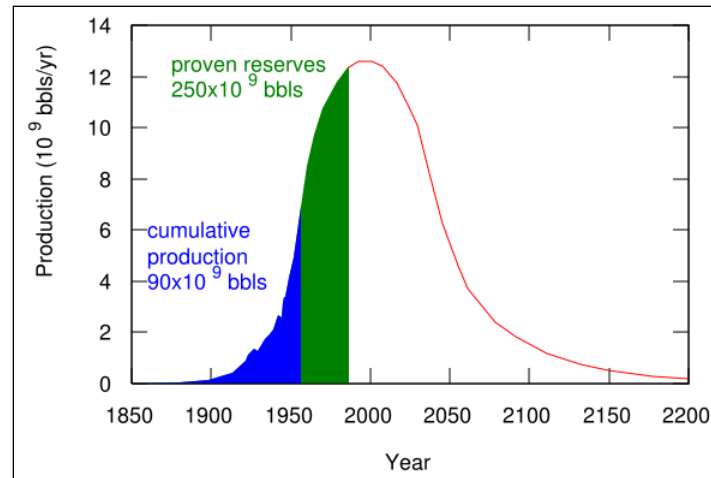

**Figure 3: Hubbert’s Curve (<http://yalibnan.com/site/>)**

The Hubbert curve can be represented by a differential equation relating the total amount of oil in the reservoir ( $Q_T$ ), the amount of oil pumped from the reservoir at time  $t$  ( $Q$ ), and the initial rate factor ( $r_0$ ).

$$P/Q = dQ/dt = r_0(1 - Q/ Q_T)$$

The rate of oil production has not changed in over 30 years. Few new oil reserves have been discovered, and the reserves in which oil is being extracted from are not being replenished. Oil production peaked in 1971 and has been in decline ever since (Fuhs).

### 1.5 Oil Reserves

Currently, the largest oil reserves reside in Saudi Arabia and other Middle Eastern countries. The United States of America ranks 14<sup>th</sup> on the list of barrels of oil produced. In 1968,

the largest oil reserve in America was discovered in Prudhoe Bay, Alaska. The discovery of this reserve was so huge that it caused oil production to be greater than oil consumption, but only for a short while.

We must also consider the fact that there are different types of oil sources. There are reservoirs of oil currently working. There are also reservoirs that have been discovered but are not in production, and there are reservoirs that have not even been discovered yet. This means that we can predict how much oil we have left from the working reservoirs, but we cannot take into account the oil reserves that have not been discovered yet. These are a few of the variables that need to be considered when predicting the rate of oil production.

### 1.6 Demands for Oil

According to the U.S. Energy Information Administration, the United States uses 69 percent of oil for transportation purposes. Because this, the HEV is designed to lessen oil consumption. The United States consumes near 25 percent of the oil in the world. The pie chart in figure 4 shows percent oil consumption by country.

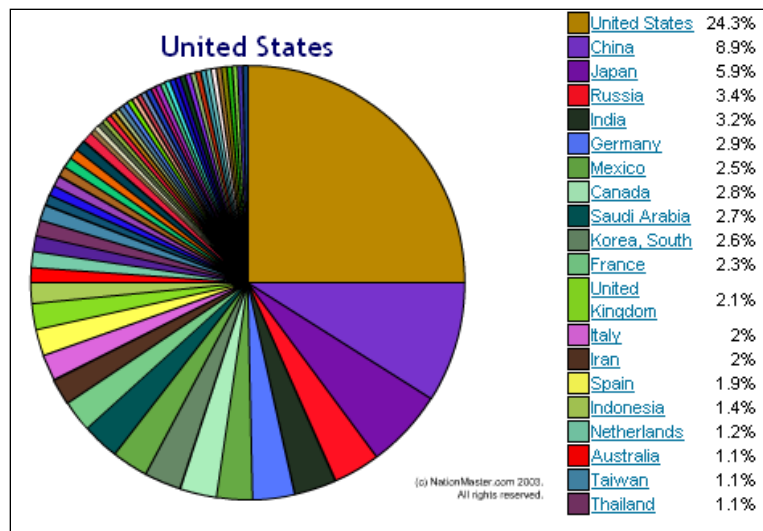

Figure 4: Percent Oil Consumption by Country ([www.nationmaster.com](http://www.nationmaster.com))

The demand for oil is increasing as time goes by, especially for countries that are starting to industrialize more. The huge economic development that has begun to characterize two of the world's most populous nations: India and China, each with more than one billion people -- could give a boost to oil demand (Clark).

Demands for oil are only rising, and according to some the peak amount of oil stored on Earth has already been discovered. It is frightening to think about the time when there will be no more oil because human life depends on it for survival. Methods in which to decrease the consumption of oil need to be implemented, and the HEV aims to be a step towards this goal.

## **2. How Hybrid Electric Vehicles Work**

In order to draw conclusions on the effects of the hybrid electric vehicle (HEV) on the environment, one must understand how HEVs operate. This section will describe in detail how HEVs work. Explanations of the different configurations of HEVs will be provided. Topics will also include descriptions of the various parts of an HEV that differ from an internal combustion engine (ICE) powered vehicle. The purpose of each component and its importance will be addressed. Examples of makes and models are also shared and discussed.

### **2.1 Why the name, Hybrid?**

The word ‘hybrid’ implies two different types of components functioning simultaneously to achieve a common goal. For an HEV, two power sources are combined to propel a vehicle. This is the basic concept for an HEV. The idea is that there is an electric motor/generator (M/G) in conjunction with the ICE to power the automobile. If there is another source of energy to drive the wheels besides the ICE, then the ICE does not have to be so large; this reduces emissions, increases mpg ratings, and uses less gasoline.

### **2.2 Power Train Configurations**

HEVs are classified according to their power train arrangements. One class of HEVs is the parallel hybrid. In this set-up, the ICE and the M/G can work together or separately to power the vehicle. When starting a parallel hybrid, the generator draws power from the battery pack and then turns the M/G which then turns over the ICE. Once the car is moving in normal cruising conditions, only the ICE is supplying power to the wheels. The fuel tank and gas engine connect to the transmission. The batteries and M/G also connect to the transmission independently. As a result, in a parallel hybrid, both the M/G and the gas engine can provide propulsion power (Layton and Nice).

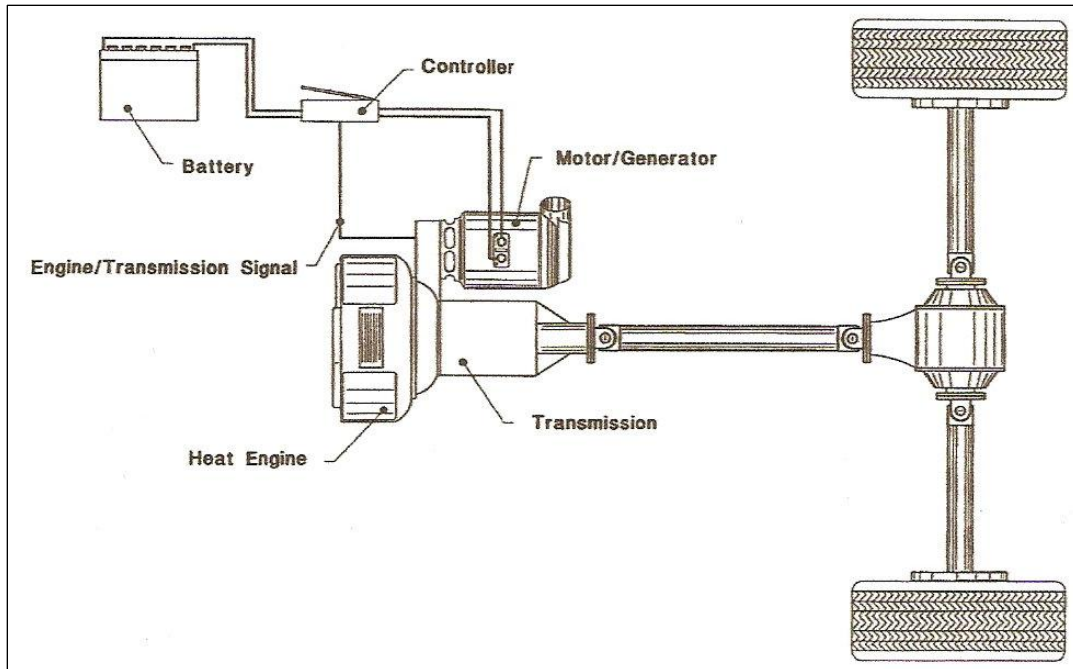
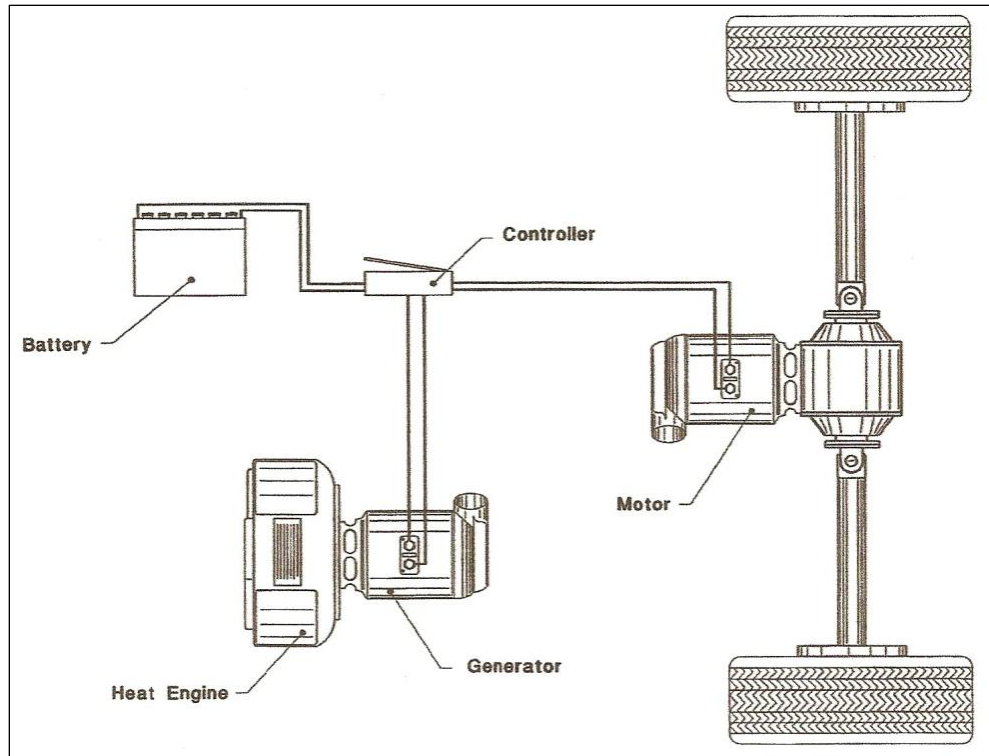

**Figure 5: Schematic of Parallel HEV (Riley)**

Figure 5 shows the geometry of a parallel HEV. When the HEV is operating under normal conditions, the vehicle is being solely run by the gasoline engine. The M/G is turned off and its clutch is open. The continuously variable transmission (CVT) is synchronized with the ICE and set to gear ratios that will allow the least amount of gasoline to be used.

While the parallel HEV is in electric only mode, the M/G clutch is now engaged, and the engine clutch is open. The batteries are supplying power to the M/G and the engine is no longer running.

Another power train configuration of the HEV is series. In a series HEV, the gasoline engine is never directly powering the wheels. The ICE turns the M/G which can either power the car or charge the battery pack. Because the M/G can deliver the required power at different rpm, the engine can operate on its ideal operating line for minimum fuel consumption (Fuhs).



**Figure 6: Schematic of Series HEV (Riley)**

Figure 6 shows the series HEV in the mode where the gasoline engine runs the generator, which powers the M/G, which in turn powers the wheels. The batteries are bypassed in this mode. However, in other modes, the generator can simultaneously charge the battery pack while supplying power to the electric motor to drive the vehicle. Power is therefore lost in this mode.

### **2.3 Function of Main HEV Components**

There are many components that an HEV is comprised of. The M/Gs, the ICE, and the battery pack are all main components that power the vehicle. These elements need a way to be monitored and controlled with sensors and controllers. Other devices, such as inverters and converters, ensure that the right type (AC or DC) and right amount of current is being supplied to the various systems in an HEV. The following sub-sections will explain the functions of the main components in an HEV.



### 2.3.1 Transaxle Assembly

Depending on the type of HEV and its power train configuration, the number of M/Gs needed varies. For example, a HEV with all-wheel-drive capabilities will need a third M/G to supply power to the rear wheels in addition to the two M/Gs supplying power to the front wheels. Most midsize HEVs use two M/Gs. One of the M/Gs is run by the ICE and used to operate the second M/G and/or charge the battery pack. It is also the responsibility of the first M/G to start the ICE. The second M/G is responsible for supplying power to the front wheels (front wheel drive). The same M/G for moving the HEV is responsible for generating electricity to recharge the HEV battery pack with when the car is coasting or during braking. The act of the second M/G generating electricity for recharging the batteries is called regenerative braking, and will be discussed more in depth in section 4.

### 2.3.2 Hybrid Vehicle Computer Control

The control systems in ICE cars today are responsible for managing many important parameters in the vehicle. These include ignition timing, temperature, oxygen content, throttle position, pressures, exhaust gas recirculation (EGR) valve position, knock, crank or cam position, and others. All of these systems are monitored by sensors placed strategically in various locations on the engine. Another important variable that is monitored is the relationship between fuel economy and emissions. Modern smart engines continuously adjust combustion to give optimal output of power, fuel economy, and emissions (Pulkrabek).

Many of the computer control systems in a HEV differ from those found in ICE driven cars. Because there are essentially two systems driving the vehicle, the controller has to manage both at the same time. With the hybrid vehicle control ECU (electronic control unit), the communications occur among multiple layers of control and communications systems: electric

motor controller, engine controller, battery management system, brake system controller, transmission controller, electrical grid controller, and some systems have 42 volts components as well (Hybrid Cars: Auto Alternatives for the 21st Century). The functions of the control system are ensuring that the vehicle is reaching maximum mpg, monitoring of the batteries and electric motor, and making sure that the exhaust is as clean as possible.

Each system in an HEV has its own ECU. The battery pack, the air-conditioning unit, the transmission, the power steering unit, the ICE, and the clutch each have their own ECU. All of these individual ECUs are controlled by the HEV control ECU. The HEV control ECU receives information for each system ECU to make sure that they are running smoothly.

The HEV control ECU also monitors the battery pack to ensure that its state-of-charge (SOC) does not drop below 30%. This is the reason why the battery pack does not need any external charging.

### **2.3.3 Inverter and Converter Assembly**

An inverter is a device that converts DC (direct-current) into AC (alternating current) and vice-versa. The HEV inverter converts the high-voltage current (approximately 300 volts, depending on the HEV) coming from the battery pack for the M/Gs.

An HEV converter drops in the voltage from the battery pack, say 300 volts, and drops it down to about 14 volts in order to supply power to the accessories of the car and recharge the auxiliary battery. (The auxiliary battery is a 12 V regular car battery isolated from the HEV 300 V battery pack). Images of a converter and inverter are provided in figures 7 and 8 on the next page.



**Figure 7: DC-DC Converter (Northborough)**

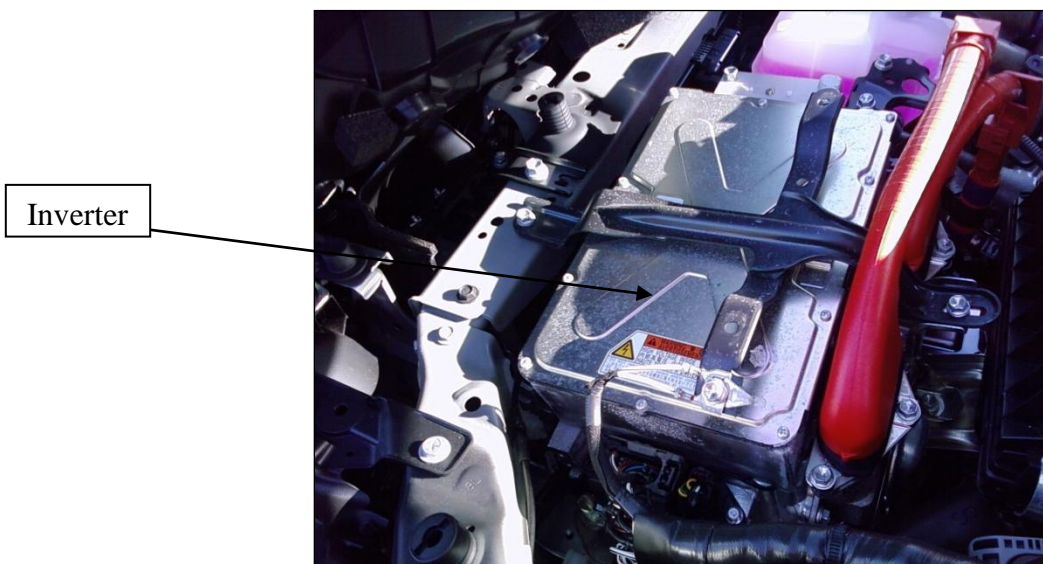

**Figure 8: Inverter-2010 Lexus HS250h (Northborough)**

## **2.4 HEV Operation**

Driving an HEV is slightly different from driving an ICE car. There are five settings on the electronic gearshift selector: drive, neutral, reverse, brake, and a separate button for park. There is also an LCD display to show the driver how the drive train is functioning and the instantaneous fuel economy of the HEV. There are three modes the HEV can be in: EV, eco-mode, and power-mode. Pictures of the instrument panel in a Lexus HS250h are shown in figure 9 on the next page.

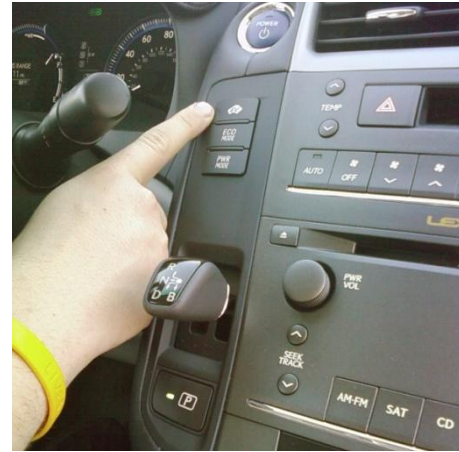

**Figure 9: LCD Display (left) and Instrument Panel (right) from Lexus HS250h (Northborough)**

When the HEV is in EV mode, only the M/G is running and being powered by the battery pack. While in eco-mode, the HEV is programmed to achieve the maximum fuel economy in city style driving (frequent stopping). Power mode enables the use of the ICE to accelerate the vehicle when the gas pedal is initially depressed.

## **2.5 Popular Hybrids on the Road Today**

The Toyota Prius is one of the largest selling hybrids on the road today. In fact, it is the number one selling HEV on the list of the top ten selling HEVs. In 2008, Toyota sold 158,886 Prius hatchbacks. That's more vehicles than the rest of the 10 best selling hybrids combined (Deaton). The Toyota Prius was marketed in Japan in the late 1990s and marketed worldwide in 2001. The 2010 Prius will be the third generation of the model. Some changes from the previous generation model include a larger electric motor, more valves per cylinder, and solar panels on the roof.

The Toyota Prius doesn't use either a parallel or series power train configuration, but instead uses a combination of the two. The power split device, which was introduced on the second generation Prius, is what makes this possible. It allows the ICE and electric motor to work together simultaneously or independently to power the HEV, just like a parallel set-up.

However, the power split device also allows the ICE to charge the batteries if necessary, as in a series configuration. The device is essentially a set of planetary gears that connects the ICE, generator, and electric motor together.

Another top selling HEV is the Honda Civic Hybrid. The ICE in a Honda Civic Hybrid is small being only 1.3 liters (compared to the 1.8 liter ICE in the Toyota Prius). The Civic Hybrid puts out 110 hp at 6,000 rpm, and the Prius puts out 98 hp at 5,200 rpm. The Prius does win the battle of trying to achieve superior mpg ratings. The Toyota Prius gets an estimated 50 mpg city/highway combined, while the Honda Civic Hybrid gets 42 city/highway combined.

Off-road capable HEVs are also available. The Lexus RX400h has four wheel and all wheel drive capabilities. The ICE is a 3.3 liter V6.

It can be seen that HEV's come in all types and sizes, from compact cars to large SUVs. The vehicle type will determine how large or small the ICE must be and the number of M/Gs needed. 4 x 4 SUVs need at least 2 M/Gs, one for the front axle and one for the rear.

### **3. The Batteries Used in Hybrid Electric Vehicles**

Batteries store electrical potential energy. They discharge to release energy and charge again to collect energy, and then the process is repeated. Batteries are one of the several electrical energy storage devices that a hybrid electric vehicle (HEV) depends on. Other electrical energy storage devices include capacitors, and super capacitors. Fuel cells are another electrochemical supply but are fuel converters as opposed to an electrical energy storing device.

The battery pack is an essential component of HEVs. Each battery in the pack is made up of many cells. The battery pack is integral to the HEV because the electric motor/generator (M/G) rely on it for power when the HEV is in electric only mode. The batteries are also important for regenerative braking (refer to section 4 for a detailed discussion on regenerative braking). In an HEV, there is one main battery pack in addition to an auxiliary battery which supplies power to activate the main relay to connect the high voltage circuit. The main battery pack is responsible for regenerative braking, propulsion of the vehicle when the HEV is in electric-only mode, and delivering power to the accessories. Vehicle accessories include features such as window motors, the radio, etc.

There are many important issues to address when discussing the energy storage devices in an HEV. These topics include the function of each of the devices, how they work to complete their respective functions, their manufacturing, their recycling or disposal, and their cost.

#### **3.1 What is a Battery?**

Batteries are used in a wide range of applications in the world today. There are two types of batteries available: batteries that can be recharged (secondary batteries), and batteries that cannot be recharged (primary batteries). In HEVs, secondary batteries are used.

Batteries can be classified according to their electrical potential, or voltage. Voltage equals one joule per coulomb:

$$1 \text{ V} = 1 \text{ Volt} = 1 \text{ J/C} = 1 \text{ Joule/coulomb (Young and Freedman)}$$

Where a joule is a unit of energy and a coulomb is a unit of charge. Therefore, voltage is the energy per unit of charge. To calculate the voltage of a battery, the electrical potential difference must be taken across its positive and negative terminals. Just as a ball held above the ground at a given distance has a gravitational potential energy; a battery with positive and negative terminals has electrical potential energy.

All batteries are made up of voltaic cells. A voltaic cell consists of an anode, cathode, and an electrolyte, where electrons flow out of the anode and into the cathode. This chemical reaction is called a reduction/oxidation, or redox reaction. The electrochemistry of these cells will be discussed in further detail in the next sub-section (section 3.2). Depending on the type of chemical that is the electrolyte, the voltage for each different type of cell will vary. For example, nickel metal hydride (NiMH) can have a cell potential of 1.2 V (Fuhs) and a lead-acid cell has a cell potential of 2 V.

## **3.2 Electrochemistry of Batteries Used in HEV Applications**

Energy can exist in many different forms, such as mechanical energy, thermal energy, chemical energy, electrical energy, etc. The purpose of the cells that batteries are composed of is to turn chemical energy into electrical energy via chemical reactions.

### **3.2.1 Battery Terminology**

Before discussing the functions of battery packs in an HEV, background information on the characteristics of batteries should be known. Electrical terms to describe batteries will be used throughout this section and are necessary to understand battery technology.

Depth-of-discharge (DOD) is the percentage of charge that the battery has used. For example, a battery with a 50% DOD has used half of its charge (DOD of 100% would indicate no charge left). This rating can also be measured in ampere-hours (Ah). The perfect battery during discharge has constant voltage at the terminals. Hypothetically, when DOD is 100%, the voltage drops abruptly to zero (Fuhs). This is shown graphically in the figure 10 below.

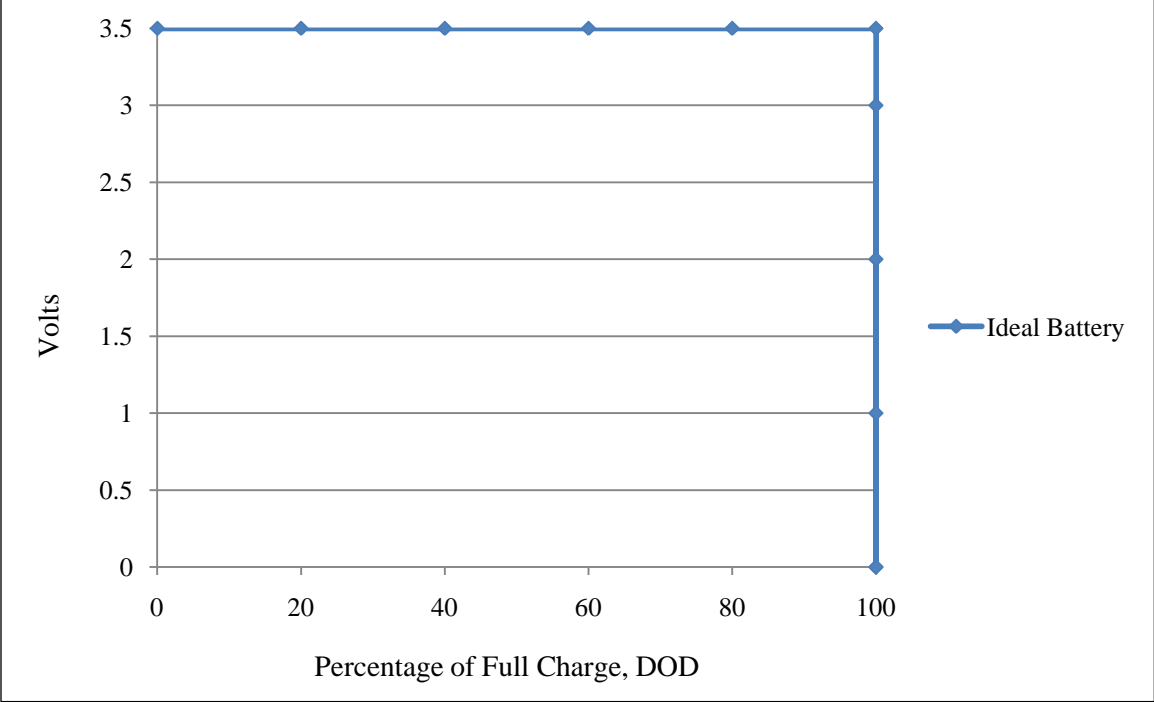

**Figure 10: Voltage for Ideal Battery vs. Depth of Discharge**

Altering the DOD of a rechargeable battery affects its cycle life. The cycle life of a battery is how many complete charges and discharges (to a DOD of 100%) it can achieve before it eventually fails (can no longer hold a charge). The lower the DOD the higher the battery cycle life is. The relationship between DOD and battery cycle life is logarithmic, and a graph of their relationship is shown in figure 11 on the next page.



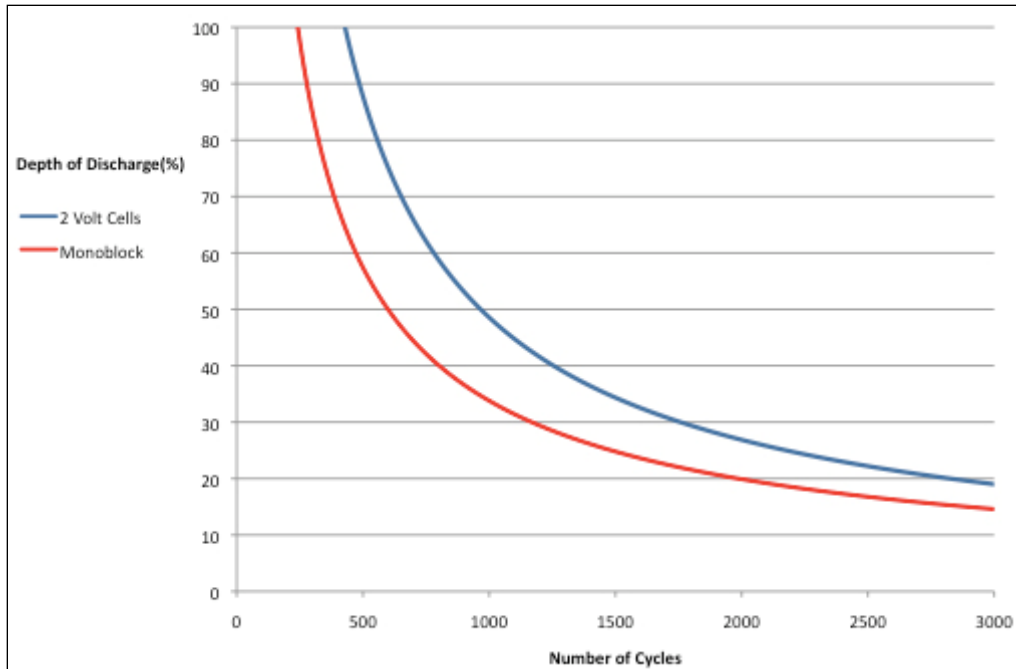

**Figure 11: Depth-of-Discharge vs. Cycle Life ([www.surette.com](http://www.surette.com))**

The state of charge (SOC) is the inverse of the DOD. While the DOD indicates how much charge has been released, the SOC specifies how much charge is left. Battery manufacturers usually specify a battery with a number of ampere-hours along with a current rate. For example, a battery labeled at 100 Ah at C/5 rate has a 100 Ah capacity at a 5 hour discharge rate (Ehsani, Gao and Emadi).

Current (I) is another important term to understand, and it is the measure of electron flow over time. The units for current are amperes (A). Energy (E) is measured in joules (J) or kilowatt-hours (kWh). Power (P), measured in watts (W), is energy per unit time. Another two important concepts to understand are specific energy ( $E_s$ ), measured in kWh/kg, and energy density ( $E_D$ ), which is measured in kWh/liter. Specific energy measures the energy of the cell per unit of mass, where the energy density measures the energy per unit volume. It is important to understand that energy density affects the amount of volume the battery occupies while the specific energy affects the weight of the battery.

### 3.2.2 Electrochemistry of Voltaic Cells

Battery packs in HEVs consist of many batteries, each of which is made up of voltaic cells. The cells are electrochemical devices that work by collecting and emitting electric charges through their electrodes. The electrodes of the cells are defined as the anode and cathode, which are positive and negative, respectively. When a battery is discharged, chemical energy is converted into electrical energy. The electrodes sit in an electrolyte, made up of an ion-rich solution. Ions are positively or negatively charged molecules. When a molecule has extra electrons, it is negatively charged. If a molecule has a deficiency of electrons, it is positively charged. The electrolyte separating cathode from the anode and can be a liquid, a gas, a gel, or a solid. The state of the electrolyte depends on the type of rechargeable battery. Electrons are always flowing out of the anode and into the cathode. This chemical reaction is known as a reduction oxidation (RedOx) reaction, because the removal of electrons corresponds to oxidation and gain of electrons corresponds to reduction. When the battery is being discharged, electrons are flowing from the negative electrode (anode) to the positive electrode (cathode). This means that the anode is the source of oxidation, and the cathode is the source of reduction. When the battery is charging, the electrodes switch roles in the reduction oxidation process. The positive electrode is now the anode, and the negative electrode is the cathode. This means that the reduction now takes place at the anode, and oxidation takes place at the cathode.

### 3.3 Types of Batteries

The rechargeable battery used in ICE cars is a single 12 V lead-acid battery. The two main types of batteries used in the battery packs in HEVs today are nickel-metal hydride and lithium-ion. The name of the battery corresponds to the electrolyte used and the material of the

electrodes. Each type of battery has different chemical reactions within its cells. The batteries also differ in their amount and type of harm to humans, the environment, and society.

### 3.3.1 Lead-Acid Batteries

The battery used in every internal combustion engine (ICE) car on the road is a 12 V lead-acid battery. This single battery is responsible for powering the alternator, or the engine starter. It also supplies power to the accessories that the car may have, such as the air conditioning, radio, power windows and locks, etc. Lead-acid batteries can also be found in HEVs. For example, the Toyota Prius uses one 12 V lead-acid battery to activate the main relay in addition to the 201.6 V nickel-metal hydride battery pack that powers the electric motor/generator (M/G).

A 12 V lead acid battery is made up of 6 voltaic cells, each having an electric potential of 2 V. Each voltaic cell has two electrodes, a positive (anode) and a negative (cathode). Attached to each electrode are 8 metal plates. The lead-acid battery works by immersing these plates in a strong (approximately 35%) sulfuric acid ( $2\text{HSO}_4^-$ ) electrolyte. The remaining 65% of the electrolyte is water. The negative plate is covered in lead (Pb), and the positive plate made of lead dioxide ( $\text{PbO}_2$ ). During the discharging process, the electrodes turn into lead sulfate ( $2\text{PbSO}_4$ ), and the electrolyte turns into mostly water ( $2\text{H}_2\text{O}$ ). This happens because as the battery is discharging,  $\text{PbSO}_4$  builds up on both the lead and lead dioxide plates. The overall chemical reaction equation is:



The charging of the battery is a chain reaction between the voltaic cells. When the metal plates are immersed in the electrolyte, electrons are released. Starting from the positive terminal of the battery, electrons flow into the anode and out the cathode of the first cell which produces 2

V. The electrons flowing out of the first cell's cathode then flow into the adjacent cell's anode, picking up another 2 V along the way. By the time the flow of electrons has released from the last cell's anode, the battery has charged to 12 V. Figure 12 is an image of the inside of a 12 V lead-acid battery.

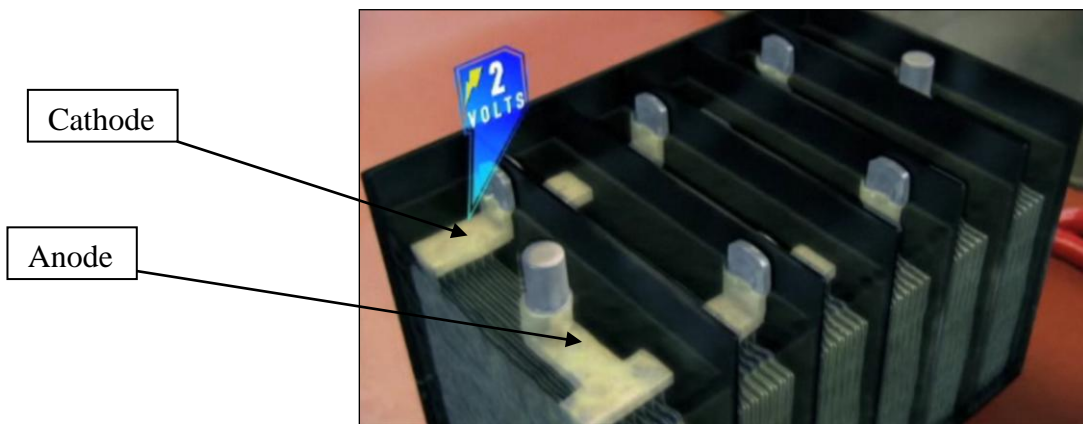

**Figure 12: Inside a 12 V Lead-Acid Battery (Deconstructed: How Car Batteries Work)**

The lead acid battery is highly toxic and dangerous to humans and the environment. The lead in these batteries can cause kidney damage, hearing impairment, and learning disabilities if ingested. Just a small drop of battery acid will eat through clothing and burn skin. Also, lead is polluting groundwater and contaminating water supplies. The auto industry uses over one million metric tons of lead every year, with 90% going to the production of lead-acid batteries.

### 3.3.2 Nickel-Metal Hydride Batteries

The type of battery used in the battery packs of most all HEVs today is the nickel metal hydride (NiMH) battery. NiMH batteries are an improvement of another nickel-based rechargeable battery, the nickel cadmium battery (NiCd). NiCd batteries are still used in some applications, but not in HEVs. The NiMH battery uses a metal hydride (a hydrogen absorbing alloy) for the negative electrode, opposed to (NiCd), where it is made of cadmium. The positive electrode of both the NiMH and NiCd batteries are the same, being nickel oxyhydroxide. The

benefit of the NiMH over the NiCd is that the NiMH battery cells can hold up to three times the capacity (electrical charge measured in volts) of the NiCd cell of the same size. NiMH batteries are also not nearly as toxic as NiCd. The electrolyte is a potassium hydroxide (KOH). When this type of battery is being charged, a direct current is applied to the cathode. Electrons are released from the cathode into the electrolyte, reversing the chemical reaction and returning the reacting materials to their original state. This causes the nickel to change from  $\text{Ni}^{2+}$  to  $\text{Ni}^{3+}$ , or oxidize. When oxidation is happening, hydrogen atoms leave the positive electrode and react with the electrolyte. Simultaneously, the negative electrode is going through the reduction stage and absorbing hydrogen atoms from the electrolyte. The overall chemical reaction for a NiMH battery is:

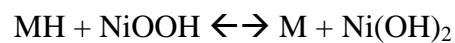

Because HEVs require large amount of voltage from their battery packs, important variables to consider when choosing the optimal battery are weight and volume. The specific energy for NiMH batteries is twice that of a lead-battery or about 80 Wh/kg. NiMH batteries are also compact having an energy density of 215 Wh/L (Riley). These are a few of the reasons that NiMH batteries are most commonly used in HEV applications. Another reason is that they provide reasonably good power and energy. The recharge time is 35 minutes for an 80% DOD, which is not very long. Other features that have made NiMH batteries the preferred battery for HEV applications include flexible cell size (0.30 Ah-250 Ah), safe operation at high voltage (320+V), readily applicable to series and series / parallel strings, choice of cylindrical or prismatic cells, tolerance to abusive overcharge and over discharge, maintenance free, excellent thermal properties, capability to utilize regenerative braking energy (regenerative braking will be

covered in section 4), and simple and inexpensive charging and electronic control circuits (Linden).

### 3.3.3 Lithium-Ion Batteries

Another type of rechargeable battery is the lithium-ion battery. Lithium ion (Li-ion) technology is relatively new, and is not yet being used in the majority of hybrids today. Li-ion batteries are most commonly found in cell phones and laptops. However, they are more costly and dangerous on a larger voltage scale. Details about handling Li-ion batteries and their cost will be discussed in this section. Toyota was anticipating using Li-ion batteries in the third generation model of the Prius. However, due to cost issues, Toyota is using the same NiMH battery pack that was in the previous model.

Just as the lead-acid and NiMH batteries are composed of cells, so is the Li-ion battery. The positive electrode is made of a lithium metal oxide, and the negative electrode is made of a lithiated carbon material. For the electrolyte, a liquid organic solution (Li-ion salt in an organic solvent) or a solid polymer can be used. During charging and discharging, lithium ions ( $\text{Li}^+$ ) are travelling back and forth through the electrolyte from one electrode to the other. The overall chemical reaction of a Li-ion cell is as follows:

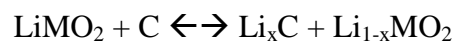

Where  $\text{LiMO}_2$  is the positive lithium metal oxide and C is the negative carbon material.

The positive lithium metal oxide electrode can be made of several different materials, such as cobalt, nickel, and manganese. The chemical formulas for these compounds are  $\text{Li}_{1-x}\text{CoO}_2$ ,  $\text{Li}_{1-x}\text{NiO}_2$ , and  $\text{Li}_{1-x}\text{Mn}_2\text{O}_2$ , respectively. Each material has its advantages and disadvantages. The advantage of the cobalt material is that it has the highest specific energy and energy density of the three. However, it is also the most expensive and discharges quicker. The

nickel material has a nominal voltage of 4 V, a specific energy of 120 Wh/kg, and energy density of 200 Wh/L, and a specific power of 260 W/kg (Ehsani, Gao and Emadi). Compare this to the NiMH cell whose specific energy is 1.5 times less than the nickel based Li-ion cell. Despite this, the energy density is more for the nickel based Li-ion cell. Lastly, the manganese material is the cheapest and its specific energy and energy density stand in-between the cobalt and nickel based materials. Therefore, manganese looks like the most logical choice for the material to use for the positive electrode in a Li-ion battery for and HEV.

As of today, Li-ion batteries are not being used in HEVs because of their cost. Because the material selection process for Li-ion batteries is evolving (as described above), it is likely that costs for this type of battery will go down in the future. The cost for Li-ion batteries is twice that of NiMH batteries. However, NiMH batteries live twice as long.

### **3.4 Manufacturing Batteries**

There are numerous automobile battery manufacturers producing OEM (Original Equipment Manufacturer) rechargeable batteries. Some of these industries include Panasonic, VARTA, SAFT, and GM-Ovonic.

#### **3.4.2 The Manufacturing of the Nickel Metal Hydride Battery**

NiMH batteries come in two shapes: cylindrical and prismatic. The shape used in the HEV application depends on the car. For example, Toyota uses a 6.5 Ah flat prismatic module consisting of 6 cells in series while Ford and Honda use 5.5-6.5 Ah cylindrical modules consisting of 5 cells welded in series (Koch). Diagrams of a prismatic battery module and a cylindrical cell are shown in figures 13 and 14 on the next page.

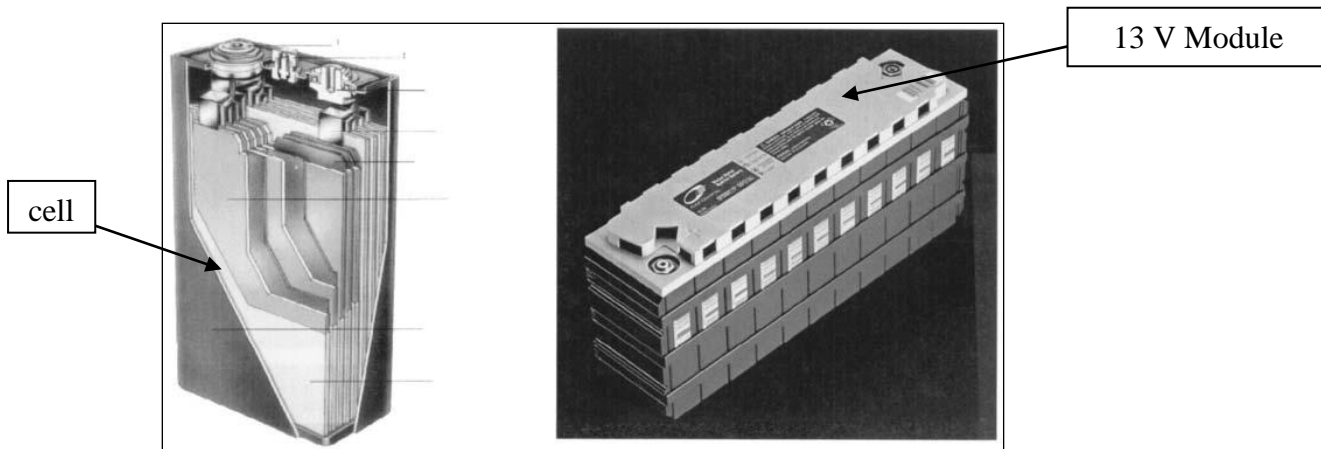

Figure 13: GM Ovonic 90 Ah Prismatic Cell and 13 V Module (Linden)

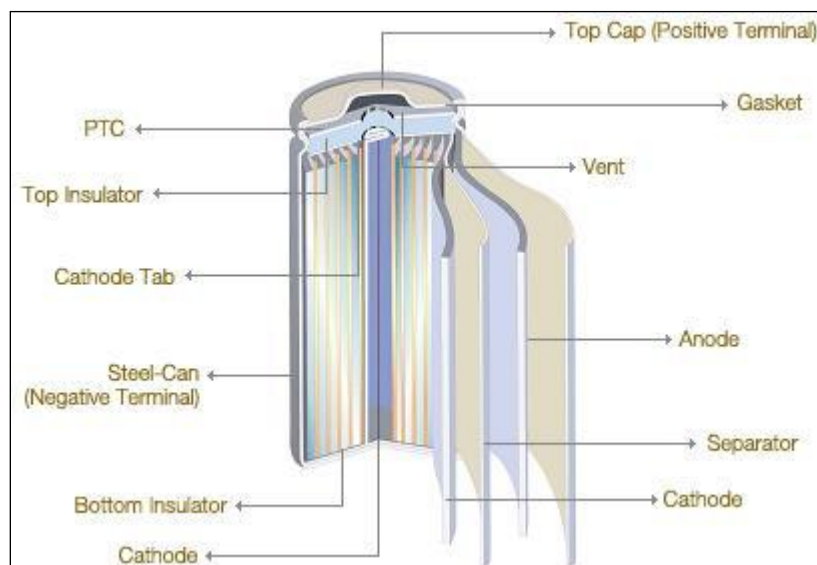

Figure 14: Example of Cylindrical Cell Design ([www.cleanmpg.com](http://www.cleanmpg.com))

The construction of a NiMH cell is similar to that of lead-acid cells in that the electrodes are made from a pasting process. The negative electrode is made by spreading a paste made of the metal hydride alloy onto a metal substrate. The substrate is a perforated foil made of pure nickel, nickel coated steel, or copper. To ensure the electrode is at the specified thickness, it is run through a press after it has dried. The nickel hydroxide positive electrode can be made one of two ways. It can be done by sintering nickel particles to the electrode so that they adhere to the electrode, or nickel hydroxide can be pasted onto a substrate similar to the process of making the



negative electrode. The electrodes are then stacked and a separator is applied between the electrodes to prevent short circuiting. For cylindrical cells, the electrodes are wound to form a solid cylinder with each electrode separated by a thin sheet of nonconductive but porous separator material and is often referred to as a jelly roll (Koch).

After the cells have been constructed they are assembled in a battery module. For example, a 7.2 V NiMH battery would require 6 cells at 1.2 V each. Once the cells have been assembled into a battery, the batteries can then be assembled into a battery pack. The pack is then tested and covered and shipped to car companies.

### **3.4.3 Constructing a Lithium Ion Battery**

There are several steps to construct a Li-ion cell. The first of which is mixing the materials used for the positive and negative electrodes. The metals used for the electrodes come in powder form and are mixed with a liquid binder. The uniform liquid is then spread onto sheets of copper (for the negative electrode) and aluminum (for the positive electrode) at specified widths. The sheets are then cut to separate the different lanes of electrodes from the one giant sheet. The sheets then pass through an oven operating at around 200°F to cure. After the electrodes have been cured, they are fed through a calender (or roll press). The calender compresses the electrode so that it is thin and uniform. The next step is winding the positive and negative electrodes together. This is done by placing a separator between the electrodes and wrapping them together in a tube shape. This step must be done tightly and precisely because the ions will be travelling through the separator to and from the positive and negative electrodes. The purpose of the separator is to prevent short circuiting while still allowing the electrodes to exchange ions (Fletcher, The Electric-Car Cheat Sheet).

After the cells have been completed and tested for voltage, assembling them into a battery is the next step. The cells are arranged in series, just like in the lead-acid battery. Depending on the manufacturer, the nominal voltage of a Li-ion cell can be around 4 V. A battery with 85 or so cells will then put out 340 V. The cells are cylindrical and are arranged to maximize space. A Li-ion battery pack for a HEV application can weigh up to 200 lbs from the combined weight of the cells.

Electronics and sensors must be hooked up to the battery packs so that the HEV controller can communicate with it. The electronics manage the voltage, temperature, and cooling of the battery pack.

The last steps in constructing the battery pack are placing a cooling system around it to keep it from overheating and to cover it so that it's protected from getting damaged in an accident. The cooling system can either be air or liquid. The cover for the battery pack is usually made out of aluminum because it is strong and light weight.

### **3.5 Battery Safety**

Because the battery packs used in HEVs hold such a high voltage, they pose a question of safety. The chemicals used in the lead-acid, NiMH, and Li-ion batteries are all dangerous to humans if the batteries were to leak. The electrolyte used in the Li-ion battery is extremely flammable because of its high vapor pressure. This can be dangerous if the HEV were in a collision where the batteries are ruptured. NiMH batteries are also dangerous to humans if they were to leak. A more in-depth discussion of the safety of batteries used in HEVs is in section 6.1.

### **3.6 Recycling Batteries**

The purpose of an HEV is to be as environmentally friendly as possible. Because the chemicals used to make these various batteries used in the HEV are so harmful to humans and

the environment, it is important to recycle them properly. All automotive parts stores are required by law to take dead batteries and dispose of them, just as they would take used oil.

For lead acid batteries, the recycling process can be done in one of two ways. One method begins with separating the battery into three components: the plastic, the lead, and the sulfuric acid. This is done by smashing the batteries into pieces and then dumping them into a liquid where the heavy metals can sink and the plastics can float. The plastic housing that the batteries are encased in is made of polypropylene. These plastic bits are turned into pellets that can be reused to make more plastic housings for the batteries. To deal with the lead, smelting furnaces are used.

Smelting furnaces (or blast furnaces) are used to smelt the lead in the batteries. The lead bits are melted in this furnace, and then it is poured into molds where the impurities in the lead can separate out. Once the lead has hardened it can be used again. The sulfuric acid can be neutralized and turned into water, or it can be made into a harmless compound called sodium sulfate. The water is then treated, cleaned, and tested in a waste water treatment plant to be sure it meets clean water standards (End Sites Recycling Processes).

Another method for recycling lead-acid batteries is to drain the battery of the acid and then put the remaining battery carcass into the smelting furnace. The furnace heats the battery to extremely high temperatures. In the furnace, they are heated up with several additives that help get rid of the impurities in the metal. These chemicals are coke, limestone, and iron. The result should be pure lead.

The process for recycling NiMH batteries is similar to that of lead-acid batteries. Recovering nickel and other substances from NiMH batteries is done by a process called high temperature metal recovery process (HTMR). The first step of this process is draining the battery

of its fluid electrolyte and metals and treating them with additives (such as carbon). The new chemicals are then turned into solid pellets and are ready to be put into a hot, 2,300 degrees Fahrenheit, furnace. The carbon in the pellets reacts with the oxygen in the air and the metals are separated, just like the smelting process.

### **3.7 Pollution Caused by Batteries**

Engineers and scientist always have environmental impacts on the top of their list when designing and manufacturing battery packs for the HEV application. Even though these types of batteries can be recycled and the chemicals used in the battery are sealed and can be harmless to the environment, there are more factors to be taken into consideration when analyzing the overall environmental impact of the batteries used in HEVs. These factors include the processes in which the batteries are manufactured and how the materials and chemicals needed for the batteries are extracted. Materials such as lead and nickel are all found in the ground, and the act of retrieving these raw materials can do harm to the environment.

#### **3.7.1 Nickel Mining**

Although the materials and chemicals in NiMH batteries are much safer for the environment than NiCd or lead-acid batteries, for example, the process for which the nickel is extracted from the earth can be environmentally damaging. This process is called nickel mining. One of the largest nickel mining facilities in North America is Vale Inco, and it is located in Sudbury, Ontario in Canada. Toyota uses nickel from this Canadian facility to supply the nickel for the battery packs used in the Toyota Prius. A few other locations for Inco's nickel mining facilities can be found in Indonesia, the United Kingdom, and Brazil.

Nickel mining works by extracting one of two types of ores from the ground. An ore is a large piece of rock composed of an array of minerals, including the metal(s) that need to be

extracted from it. The two types of ores containing nickel are lateritic and sulfuric ores. The ores found in the Inco mining plant in Canada are sulfuric. The nickel needs to be isolated from the ore and then refined to be used in a nicked based battery. The process for isolating the raw nickel is called smelting. Smelting nickel can be done by either a flash smelting or electric smelting. Flash smelting is the most common process.

Flash smelting works by placing, for example, the sulfuric ore into a furnace and supplying pre-heated oxygen-enriched air through the top of the furnace. What is produced from the reaction in the furnace is a liquid (matte) that contains approximately 45% nickel. The low-grade matte settles at the bottom of the furnace and a layer of less dense 'slag' rests on top of it. The slag is skimmed from the matte and sent to be cleaned and then discarded. The matte is then processed in Peirce-Smith converters to form a higher grade nickel matte. More slag is produced in the converting process, which is also sent to the slag cleaner. The other substances in the matte are iron and sulfur, and they need to be removed by means of refining. A diagram of a typical nickel flash smelting process is shown in figure 15 on the next page.

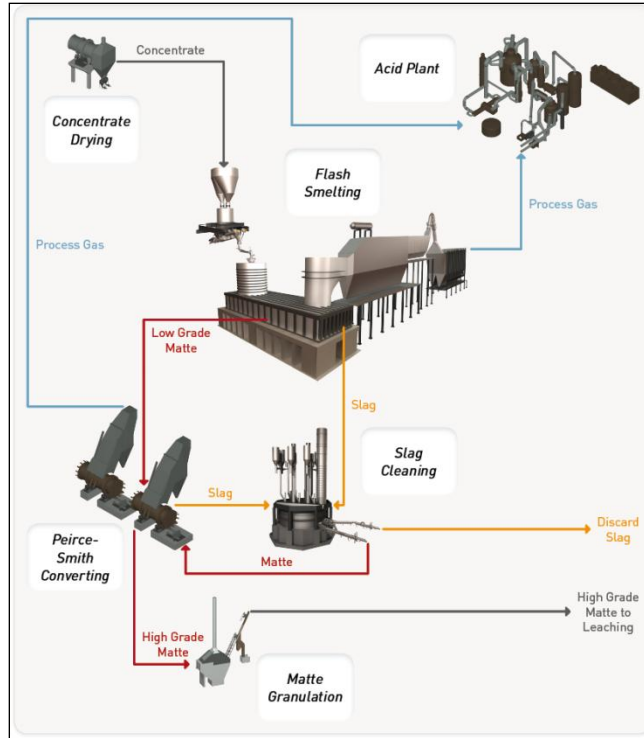

**Figure 15: Nickel Flash Smelting ([www.outotec.com](http://www.outotec.com))**

To obtain high quality nickel (up to 99.98% nickel), one of many methods can be used. Electro winning, chlorine-hydrogen reduction, fluid bed roasting, and the carbonyl process can all produce high quality grades of nickel. The nickel mining facility Vale Inco in Canada uses the carbonyl process to refine their nickel. The carbonyl process works to refine nickel by exposing the impure nickel to carbon monoxide in which it reacts and forms nickel carbonyl gas ( $\text{Ni}(\text{CO})_4$ ). Using thermal shock decomposition, fine or extra fine nickel powders can be made (Jones). The advantage of the nickel carbonyl process is that super-fine nickel particles can be produced.

In section 1, we discussed how the ICE car polluted the environment in several ways, such as air pollution and the greenhouse effect. Some of these pollutions can also be demonstrated in the act of nickel smelting. Converting sulfuric ores into pure nickel by means of smelting emits sulfur dioxide ( $\text{SO}_2$ ).  $\text{SO}_2$  releases can be as high as 4 metric tons of  $\text{SO}_2$  per

metric ton of nickel produced (Cheremisinoff). When SO<sub>2</sub> mixes with the gases in the atmosphere, acid rain is produced. Acid rain is harmful for vegetation and the regeneration of it (as was explained in section 1).

Depending on the metal hydride alloy, the nickel hydroxide, the negative substrate and casing choice of the manufacturer, a NiMH battery can use anywhere from 35-50 percent of its weight in nickel. Consider the Toyota Prius, which uses NiMH batteries with a nominal cell voltage of 1.2 V and each battery consists of 6 cells making the battery have a voltage of 7.2 V. The Toyota Prius uses a 201.6 V. This means that there are 28 battery modules in the battery pack of a Toyota Prius. A battery having a nominal voltage of 7.2 V weighs 1.04 kg. With that said, consider these calculations for the Toyota Prius:

$$\underline{1.04 \text{ kg} \times 0.50 = .52 \text{ kg}} \quad \leftarrow .52 \text{ kg is the amount of pure nickel per battery}$$

Multiplying the weight of one battery by 0.50 yields 50 % of the battery's weight, which is how much nickel the battery consists of.

$$\underline{.52 \text{ kg} \times 28 = 14.56 \text{ kg}} \quad \leftarrow 14.56 \text{ kg is the amount of pure nickel per battery pack}$$

Multiplying the amount of nickel per battery by the number of batteries in one pack yields the amount of nickel in one battery pack for an HEV.

$$\underline{1,000 \text{ kg} \div 14.56 \text{ kg} = 68.68} \quad \leftarrow 68.68 \text{ is the \# of battery packs per metric ton of nickel}$$

One metric ton is equivalent to 1,000 kg. Dividing one metric ton by the amount of nickel per battery pack yields the number of battery packs produced for every metric ton of nickel mined.

$$\underline{4,000 \text{ kg} \div 68.68 = 58.24 \text{ kg}} \quad \leftarrow 58.24 \text{ kg is the amount of SO}_2 \text{ released from one pack}$$

4,000 kg (or 4 metric tons) of SO<sub>2</sub> is released into the atmosphere for every 1,000 kg of nickel mined. Dividing 4,000 kg by the number of battery packs produced from one metric ton of nickel yields the amount of SO<sub>2</sub> released from making one battery pack for the Toyota Prius.

The release of particulates and soot into the atmosphere is another side effect of nickel smelting. As mentioned in section 1, particulates are liquid droplets suspended in the air that act as pollution. Depending on the type of furnace used for the smelting process, the release of particulate matter can range from 0.2 – 5.0 kg/t of nickel produced. Using 68.68 as the number of battery packs produced per metric ton of nickel mined, dividing 0.5 kg by 68.68 yields about 7.28 grams. 7.28 grams is approximately how much particulate matter is released into the atmosphere from producing one battery pack.

The dust accumulated from digging up the sulfuric ores is a source of air pollution. The area surrounding the various nickel mining facilities around the world have some of the poorest air quality of anywhere on Earth and look desolated. The high concentrations of SO<sub>2</sub> being released from the mine cause heavy amounts of acid rain, which in turn kill many of the nearby trees. An image from NASA’s Earth Observatory website shows the SO<sub>2</sub> concentration at a nickel mine in Norilsk, Russia is shown in figure 16:

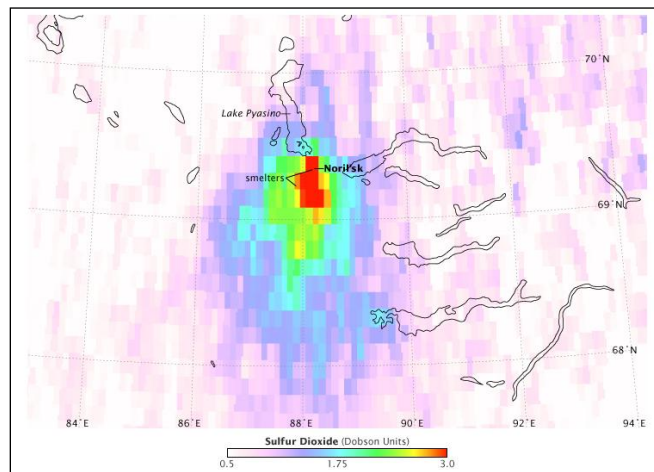

**Figure 16: SO<sub>2</sub> from Norilsk, Russia Nickel Mine (<http://earthobservatory.nasa.gov>)**

Soot and metal particles fly into the air while digging up the ores and processing them. The soot then settles into the water of nearby rivers and ponds creating large amounts of sludge.



Another measure of the pollution from nickel mines by how much they affect the land they reside in can be seen from a nickel mine in Tanjung Buli, which is located just off the shore of Indonesia. The World Bank, an organization dedicated to the funding of reconstructing poor countries, documented their sightings upon visiting that particular mine. They observed notable heavy sedimentation in the coastal zone, muddy gullies marking the slopes below the mine site, as well as oil discharges just offshore (The Impact of a Nickel Mine in Tanjung Buli, Indonesia). Images from the mining site are shown in figures 17, 18, and 19.



**Figure 17: Mudslides near Nickel Mining Plant in Indonesia (The Impact of a Nickel Mine in Tanjung Buli, Indonesia)**



**Figure 18: Suspended Sediments on Coast of Nickel Mine (The Impact of a Nickel Mine in Tanjung Buli, Indonesia)**



**Figure 19: Oil Slicks Near Nickel Mine in Indonesia (The Impact of a Nickel Mine in Tanjung Buli, Indonesia)**

The impact that HEVs have on the environment can be seen from this evidence as well as predicted. The more HEVs that are produced requires more batteries to be produced which requires more nickel to be extracted from the ground which in turn requires the nickel mining industry to be expanded which can pollute the environment more than necessary. Generating HEVs has a chain reaction of events that follow it, and these reactions may cause more harm to the environment than good in the long run.

## 4. Regenerative Braking and its Importance in an HEV

In terms of safety, braking is one of the most important features of a vehicle. However, while braking, a significant amount of energy is wasted. The design and control objectives in a hybrid electric vehicle (HEV) braking system are (1) sufficient braking force to quickly reduce the vehicle speed (2) proper braking force distribution on the front and rear wheels to ensure vehicle stability during braking; (3) and recovery of as much braking energy as possible (Ehsani, Gao and Emadi).

Regenerative braking in HEVs is a way of making use of the otherwise wasted energy produced while braking. In regenerative braking, kinetic energy of the HEV is converted into electrical energy which is used in charging the battery pack. The general idea is that when the brakes are being applied, or the car is coasting down a hill, the electric motor/generator (M/G) reverses direction and acts as an electric generator that charges the battery pack.

HEVs are not the only application for regenerative braking. Trolley cars, in San Francisco for example, have been using this concept for decades. The generated power goes back into the power lines (Fuhs).

In this section, friction brakes will be termed ‘non-regenerative’, i.e. the hydraulic powered disc brakes on the wheels, and will be used as a comparison to regenerative braking. Before diving into this section, some symbols, their meaning and units must be established.

<u>Symbol</u>	<u>Meaning</u>	<u>Units</u>
$m$	mass	Kg (kilograms)
P	power	W or kW (watts or kilowatts)
$\mu$	friction coefficient	unit less
W	weight	N (Newton)
t	time	s or hrs (seconds or hours)
E	energy	J (joules)
V	velocity	m/s or mi/hr (meters/second or miles/hour)
F	force	N (Newton)

**Figure 20: Table of Symbols for Regenerative Braking Equations**

## 4.1 Brakes, Wheels, and Tires

In order to understand regenerative braking, it is necessary to understand the forces on the tires and the road. These forces determine how much energy can be returned to the batteries. In an HEV, braking is more than just slowing down the car. A new factor of recharging the batteries is added to the mix.

### 4.1.1 Slip

One of the relationships between the tires and the road can be characterized by slip. Slip results in the compression and stretching of the rubber tire and the change from static coefficient of friction to dynamic. Slip occurs when the tire is moving faster than the car is moving. When the tires have slip during braking, the car will travel farther than desired because the tire is being stretched. When the tires have slip while the vehicle is accelerating, the distance the car moves per one revolution of the tire is lessened. This is due to the tire being compressed. In addition, when the wheels are slipping, the coefficient of friction is changing from static to dynamic (regardless if the car is braking or accelerating). The static coefficient of friction is larger than the dynamic coefficient of friction; therefore the tires have less traction with slip because the coefficient of friction changed from static to dynamic.

100% slip occurs when the wheel is spinning but the car is not moving. This can be demonstrated by a powerful car at a complete standstill “burning-out” the tires. 100% slip can also be demonstrated when braking, as the wheels lock up and the car slides to a stop.

### 4.1.2 Tire Forces

The Forces on the tires can be longitudinal and lateral. Longitudinal forces are directed along the tire tread, and lateral forces are perpendicular to the motion of the direction of the tire.

These two forces depend on the friction coefficient,  $\mu$ , between the tire and the road surface. The tire force is represented by the equation,

$$F = \mu W$$

Where  $W$  is the weight on the tire. The friction coefficient varies depending on the road conditions (dry, wet, ice, snow, sand, etc.).

The longitudinal tire forces change if the tires have traction or if there is braking involved. In traction, the friction coefficient and the percentage of slip vary linearly with each other. However, the relationship between  $\mu$  and slip reach a maximum (about 20% slip) until the wheel is spinning with no vehicle motion (100% slip). A graphical representation of this concept is shown in figure 21:

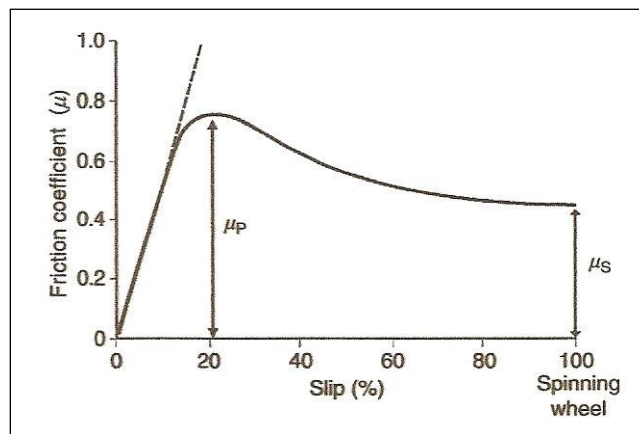
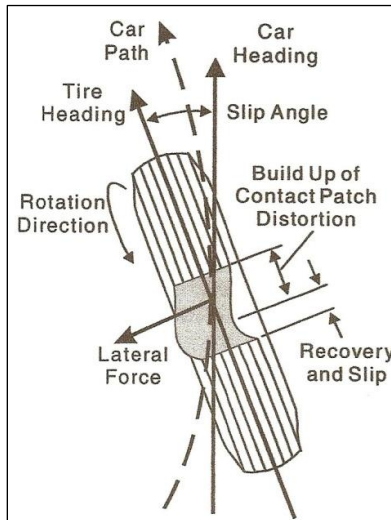

**Figure 21: Friction Coefficient vs. Slip Percentage (Fuhs)**

In braking, the friction force and the slip percentage relationship varies with different road conditions. The maximum friction force the tires can achieve while rolling is much greater on dry pavement than on icy pavement.

Lateral forces on the tire are important when cornering. Lateral forces depend on slip angle. If the car is not turning, there is no slip angle. The lateral force reaches a maximum when the slip angle is about 10 degrees. Other factors, such as tire design and structure, affect the

relationship between the lateral forces and slip angle. However, those topics are beyond this paper. A diagram of a wheel in a corner with a lateral force and slip angle is shown in figure 22:



**Figure 22: Slip Angle (Haney)**

## 4.2 Energy Recovered From Regenerative Braking

The amount of energy that can be recovered from regenerative braking depends on how much voltage the battery can accept at the given moment, how much voltage the generator can provide, and how the vehicle is slowing down.

If the battery is at a high state-of-charge (SOC) or high temperature, it may not be able to accept any voltage from the generator. The battery will accept more charge the lower the SOC. As charge rate climbs, internal resistance goes up and energy is increasingly converted into waste heat (Riley). Also, if the generator cannot produce more voltage than the battery has in it, then the kinetic energy can't be turned into electrical energy. The motion of the vehicle will also determine how much charge will be put into the battery. Coasting down a hill will provide more charge than coasting to a stop or braking to slow down. When coasting down a hill, the vehicle is

not only retrieving kinetic energy from the motion but also potential energy from the height of the hill.

### 4.3 Importance of Regenerative Braking to an HEV

Regenerative braking influences several aspects of the HEV, such as the stopping distance of the vehicle, the amount of time it takes to stop, and braking stability.

The stopping distance for friction brakes depends of the velocity squared, whereas the stopping distance for regenerative braking depends on the velocity cubed (Fuhs). The equation to calculate stopping distance for when the HEV is relying on solely regenerative braking is:

$$Sd = \frac{m}{3P}(V_0)^3$$

where  $Sd$  is the stopping distance in meters,  $m$  is the mass in kg,  $P$  is the braking power in kW, and  $V_0$  is the initial velocity in m/s.

The equation for time to stop for regenerative braking alone is:

$$t = \frac{E}{P}$$

where  $t$  is the time to stop,  $E$  is the initial kinetic energy ( $\frac{1}{2}m(V_0)^2$ ) measured in Joules, and  $P$  is the braking power in kW.

The distance it takes to stop an HEV at a given speed and the time it takes to stop are important to analyze because the regenerative braking system changes those two factors from the way a non-hybrid with only friction brakes would stop. The time to stop and stopping distance depend on the power to mass ratio of the vehicle. When the HEV is relying solely on the regenerative braking system to stop, the stopping distance for any given speed will be larger than a non-hybrid with the same power to mass ratio. For example, an HEV with a power to mass ratio of 40 W/kg going 30 m/s (about 67 mph) will stop in about 248 m (814 ft). A graphical

representation of the relationship between stopping distance and velocity for various power to mass ratios is shown in figure 23:

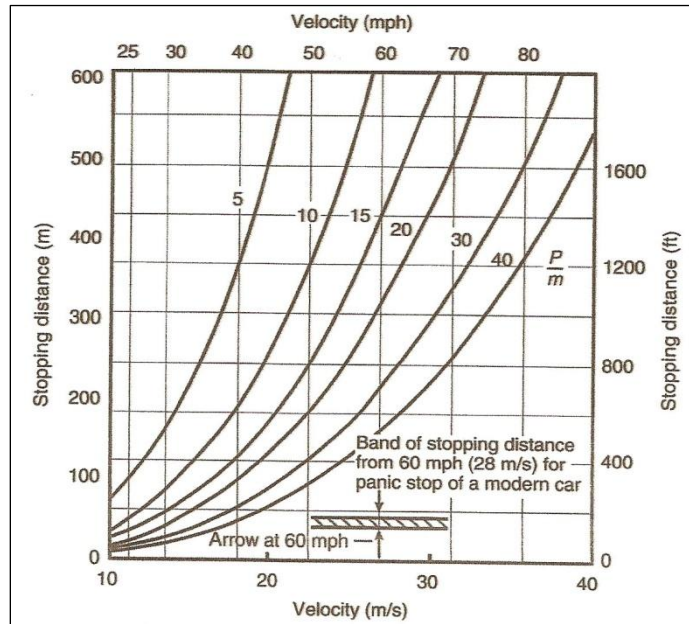

**Figure 23: Using  $P/m$  Ratio to Determine Stopping Distance at a Given Velocity (Fuhs)**

From this graph it is easy to see that as the power to mass ratio  $P/m$  increases the stopping distance decreases.

Braking stability is important when designing braking systems. When braking, the weight of the vehicle is shifted to the front wheels causing the center of gravity to shift. A diagram of what the braking forces look like is shown in figure 24:

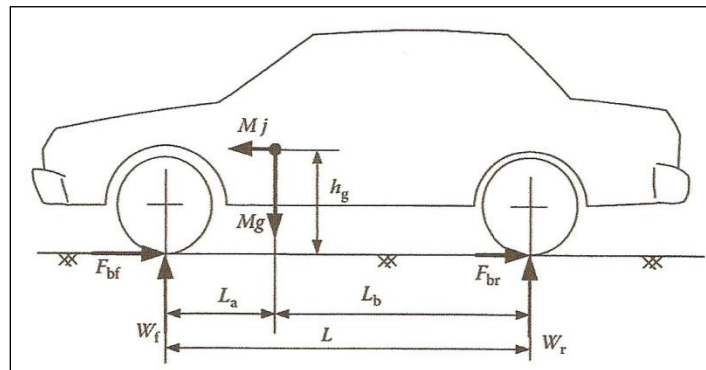

**Figure 24: Braking Forces acting on Vehicle (Ehsani, Gao and Emadi)**



where  $M_g$  is the force from the vehicle weight, located at  $h_g$  (the height of the center of gravity).  $L$  is the length of the wheelbase,  $L_a$  is the distance from the center of gravity to the center of the front wheels,  $L_b$  is the distance from the center of gravity to the center of the rear wheels, and  $W_r$  and  $W_f$  are the weights on the front and rear tires, respectively.  $F_{bf}$  and  $F_{br}$  are the braking forces on the front and rear tires, respectively.

#### 4.4 Combining Friction Braking with Electric Regenerative Braking

The amount of braking required to slow down the vehicle the driver's specified amount can be purely regenerative, purely friction braking, or a combination of both. Friction braking and regenerative braking can work together as a system to slow down the vehicle. The braking force of the system will come from the regenerative brake completely if the regenerative braking force is bigger than the system braking force. On the contrary, if the regenerative braking force is smaller than the system braking force, the rest of the braking force will be provided by friction braking (Datong, Ming and Zhenjun).

An important concept in the discussion of optimizing the energy recovered from regenerative braking is the inertia of the car. Inertia describes the ability of a mass to resist change in motion. For example, it is more difficult to accelerate a large mass opposed to a mass relatively small to it because the larger mass has a greater inertia.

The controllers for the regenerative braking system are what optimize energy recovering depending on how the car is decelerating and the car's inertia. Inertia, however, is not a *force*. Depending on how many g-forces (g-forces represent how many times more than gravity one is accelerating) are created while braking, the ratio of regenerative braking to frictional braking will differ. With a deceleration of less than about 0.3g, only regenerative braking is required. G-

forces much greater than 0.3g require the assistance of the friction brakes. The control logic for the front and rear wheels is shown in the diagram in figure 25:

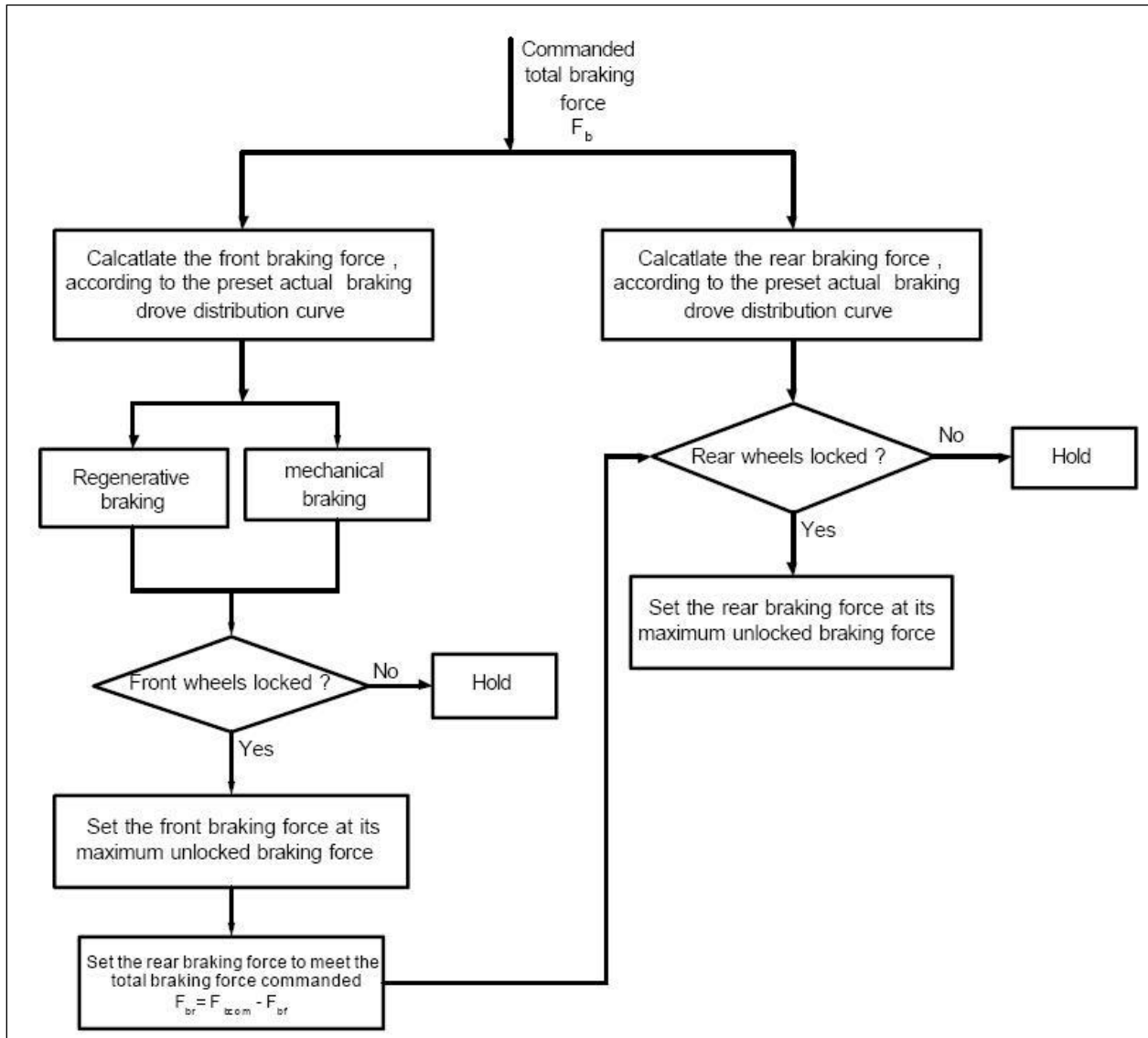

**Figure 25: Control Logic for Brake Forces (Ehsani, Gao and Emadi)**

From the diagram, it is shown that the regenerative braking controller senses the output from the driver and then determines the braking force needed for the front and rear wheels independently. Then the ratio of friction to regenerative braking is determined, and the correct braking force is established in order to stop the car.

## **5. Economics of Hybrid Electric Vehicles**

Now that the environmental impact of hybrid electric vehicles (HEVs) has been discussed, it is time to investigate the societal impact of HEVs and how they affect the economy. HEVs cost more to produce for manufacturers and more to buy for consumers than internal combustion engine (ICE) cars. Manufacturers add a price premium to HEVs based on a comparable conventional vehicle (CV). The CV gives a basis for calculating the price premium. Most hybrid vehicles on the market today are modifications to existing models of cars. For example, Honda markets the Honda Civic and the Honda Civic Hybrid. Not many car companies start from scratch when making an HEV, however, Toyota succeeded in doing so with the Prius. The CV used to compare the Prius with is the Toyota Corolla. Added electrical drive components, the complex drive train and additional weight are factored into the price premium. The question is then; does the money saved from spending less on gasoline make up for the extra expense of the HEV? There are many factors to consider when attempting answering this question, such as tax breaks for HEV owners, cost to insure, cost for maintenance, repairs, and other incentives.

### **5.1 Owning an HEV**

Owning a HEV is different from owning an ICE car. Practices such as paying taxes for the vehicle, buying gasoline, maintenance, repairs, insurance, and driving the vehicle are different in an HEV than an ICE car.

#### **5.1.1 Taxes**

In today's society, owning an HEV comes with a multitude of benefits. Depending on the state, the government will issue tax breaks for those who own HEVs. There is also a tax break given from the federal government. For example, 2010 Cadillac Escalade Hybrid SUV owners

received a \$2,200.00 tax credit on their 2010 federal tax return. However, these tax breaks have limits. Once a manufacturer (such as Toyota or Honda) sells 60,000 vehicles, the tax credit gradually decreases over a period of 15 months until it is phased out entirely. While the act keeps the tax credit in effect until 2010, Toyota has already reached its cap, and credit for Toyota and Lexus vehicles is no longer available. Also, as of January 1, 2009, credits will no longer be available for Honda (Baukus).

As mentioned above, many HEVs can receive tax credits. However, there are also tax deductions, which are different from tax credits. Tax deductions take into account the tax bracket you fall into. If you are in a low tax bracket, then the deduction you get will be much less than if you were in a higher tax bracket. For example, if the HEV you own calls for a \$2,000.00 tax deduction and you fall in the 10% tax bracket, multiplying the deduction by the tax bracket percentage yields a mere \$200.00. Using the same HEV, a person in the 35% tax bracket will receive a \$700.00 tax deduction. From this, it is clear that a tax credit is more valuable than a tax deduction.

When trying to figure out if the extra expense of buying an HEV will be recovered by fuel saving and tax benefits, it is advantageous to know how much of a tax break you will be getting, if you will even be getting one at all because of expired programs. One must also consider the sales tax paid on the vehicle. The more money spent on the HEV due to the price premium increases the sales tax on it. The sales tax varies from state to state and sometimes between cities for large states. Assuming a sales tax of 9.0% and a price premium of \$3,000.00, the extra cost due to the sales tax is  $(0.09) * (3,000) = \$270.00$ . Some states do, however, not have a sales tax; but those states make up for that by increasing other fees and charges that go into buying a vehicle.

### 5.1.2 Example Purchase of a Hybrid Electric Vehicle

Consider a comparison between the 2008 Honda Civic LX 5MT and 2008 Honda Civic Hybrid. The chart below shows the process of buying both vehicles with all the registration fees and taxes taken into account. Of course, some of the numbers are approximated, such as the miles driven in one year and the cost of gas per gallon. All the tax numbers reflect the circumstances of the state of Massachusetts in the year 2008. The chart serves to give a general idea of what purchasing an HEV entails.

	2008 Honda Civic LX 5MT	2008 Honda Civic Hybrid
Fuel Economy (Combined MPG)	30	42.5
Price of Unit	\$16,577.75	\$21,080.75
Title Preparation Fee	\$5.00	\$5.00
Documentation Preparation Fee	\$294.75	\$294.75
Registration Fee	\$75.00	\$75.00
Tax (5% Because 2008)	\$828.89	\$1,054.04
Total Contract Price	\$17,781.39	\$22,509.54
Tax Incentive	\$0.00	(\$525.00)
Total After Incentives	\$17,781.39	\$21,984.54
Price Difference Between Cars	\$4,203.15	
Miles Per Year	15,000	15,000
Cost Of Gas (87 Octane) Per Gallon	\$3.499	\$3.499
Cost to drive one year in gas	\$1,749.50	\$1,234.94
Annual Gas Cost Difference	\$514.56	
Time to make up cost difference (years)	8.17	

**Figure 26: Table Comparing 2008 Honda Civic to its Hybrid Counterpart**

Looking at the table, the registration fees and documentation fees are the same for both cars. The important differences are the fuel economy ratings (provided by the Environmental Protection Agency), the cost of each vehicle (provided by Bernardi Honda in Natick, MA), and the tax incentive (provided by [www.fueleconomy.gov](http://www.fueleconomy.gov)). These are some of the main factors to

consider when purchasing an HEV. The 8.17 years comes from dividing the price difference between the cars (price premium) by the annual gas cost difference. This quotient gives the amount of time it would take in years to accumulate the price premium through gas savings. Other factors that are not represented in this chart are depreciation, cost of replacement parts, and insurance. These factors are too variable to approximate values for in the chart; however, they should also be taken into consideration when purchasing a hybrid. They will also be discussed conceptually in the following sections.

Discussion of specifically the fuel savings equation is described more in depth in the next section (section 5.1.2).

### 5.1.3 Fuel Savings

The biggest selling feature by far is the fuel savings achieved by an HEV. For example, the 2010 Toyota Prius gets an estimated environmental protection agency (EPA) gas mileage rating of 48/51 city/highway. This is an impressive ratio compared to most midsize vehicles today that average around a 25/30 city/highway gas mileage rating. Using the miles per gallon (mpg) rating of an HEV, it is easy to calculate annual savings with a simple formula. The annual savings from the cost of gasoline in dollars per year can be represented by the following equation (a derivation of this formula can be found in Appendix A):

$$\text{Savings} = D * G_c \left( \frac{1}{F_{cv}} - \frac{1}{F_h} \right)$$

Where  $G_c$  is the cost of gasoline per gallon,  $D$  is the average distance driven per year in miles,  $F_{cv}$  is the estimated mpg rating for the CV in miles per gallon, and  $F_h$  is the estimated mpg rating for the HEV in miles per gallon. Using the 2010 Toyota Prius as an example, again, let us calculate the annual savings from fuel economy. With  $G_c = \$5.00/\text{gal}$  (approximated),  $D = 15,000 \text{ mi/year}$

(approximated),  $F_{cv}=29$  mi/gal (using a Toyota Corolla as the CV) and  $F_h=51$  mi/gal, the annual savings is:

$$\text{Savings} = (15,000 \text{ mi/yr}) * (\$5.00/\text{gal}) \left( \frac{1}{29 \text{ mi/gal}} - \frac{1}{51 \text{ mi/gal}} \right) = \$1,116/\text{year}$$

Continuing with this example, let us calculate the time it would take to accumulate the amount of money used to pay for the price premium based on fuel savings alone (not taking into account tax credits or deductions). Considering the price premium to be \$4,600.00 and dividing it by the savings per year, it would take 4.12 years to recuperate the money lost from the price premium. A detailed chart of makes and models of other HEVs besides the Toyota Prius is provided in Appendix A.

### 5.1.3 Insurance

Automobile insurance for HEVs is arguably higher than their CV counterparts. This is so for reasons such as safety, cost of collision repairs, and availability of HEV car parts.

As discussed in section 4, driving an HEV is different than an ICE car in terms of its handling, stopping distance, stopping time, and how its weight is shifted. The weight of the vehicle will affect its safety. This is because as the car accelerates or decelerated the center of gravity is shifted, and this impacts how likely it is that the vehicle will roll. Because of the added weight and its effects on the vehicles center of gravity and the difference in braking performance, the HEV may be deemed less safe. This may make the insurance premium more expensive because the rates for the bodily injury and medical portion of the insurance will increase.

Getting into an accident in an HEV might prove to be more costly than getting into an accident in its CV counterpart. Components to the drive train, such as electric motors and controllers for the regenerative braking system, could be damaged in a collision. These parts may

only be found at specific dealers or not as readily available. This will make the insurance premium go up because there is then little to no competition between small independent body shops.

#### 5.1.4 Depreciation

Depreciation affects how much money a vehicle is worth for resale and trade. The longer a car is owned, the less money it will be worth when trying to sell it or trade it in. A prospective HEV buyer should take this factor into consideration.

One of the major components that depreciate is the battery packs in HEVs. NiMH battery packs for HEV applications undergo specific tests to simulate driving conditions. The tests emphasize power capabilities and not DOD because an HEV requires a significant amount of power. The life span of the battery packs are measured in two ways, number of cycles and number of miles. A NiMH battery pack for an HEV will last approximately 150,000-180,000 miles. Most warranties on battery packs end at 100,000 miles or 8 years. If a person drives 15,000 miles per year on average, then:  $\frac{150,000}{15,000} = 10.0$  years. According to a sales representative from the local Lexus dealership, the replacement cost of a battery pack ranges from \$3,000.00 to \$5,000.00.



## **6. Hybrid Vehicle Safety**

Every make and model car must pass numerous intense safety tests before it can be released onto the market. Even though some cars are safer than others, all cars must meet federal safety standards. How a vehicle performs in a crash and its susceptibility to roll over all determine its safety rating. The National Highway and Traffic Safety Agency (NHTSA) perform rigorous endurance tests on all vehicles. A vehicle's safety rating ranges from 1 star to 5 stars with 1 being the least safe and 5 being the safest.

All vehicles have stored energy in them, which can have consequences in a collision if not prepared properly. The forms of stored energy are different in non-hybrid vehicles from hybrid electric vehicles (HEVs). There are different risks involved in driving an HEV, and those risks are discussed in this section.

### **6.1 High Voltage HEV components**

The battery pack is a source of high voltage in an HEV. The placement, the enclosure, and the thermal management/operation of the battery pack all affect the safety of the vehicle. Figure 27 is a table of the voltages of battery packs for different HEVs and the corresponding type of battery.

Make/Model HEV	Battery Type	Nominal DC Voltage (V)
2010 Lexus HS250h	NiMH	244.8
2010 Honda Insight	NiMH	100.8
2010 Ford Fusion	NiMH	275
2010 Toyota Prius	NiMH	201.6

**Figure 27: Table of Battery Pack Voltages in Various HEVs**

Serious damages can occur if the battery pack were exposed to extremely high temperatures for a long period of time. The battery pack can be found underneath or behind the rear seats in an HEV. Because the pack is in these locations, there are vents on either side of the seats that must never be blocked. Figure 28 shows these vents on a Lexus model hybrid and figure 29 includes diagrams of a battery pack behind and underneath the rear seats in a HEV.



**Figure 28: Vents for Battery Pack in Rear Seats of Lexus Model HEV (Northborough)**

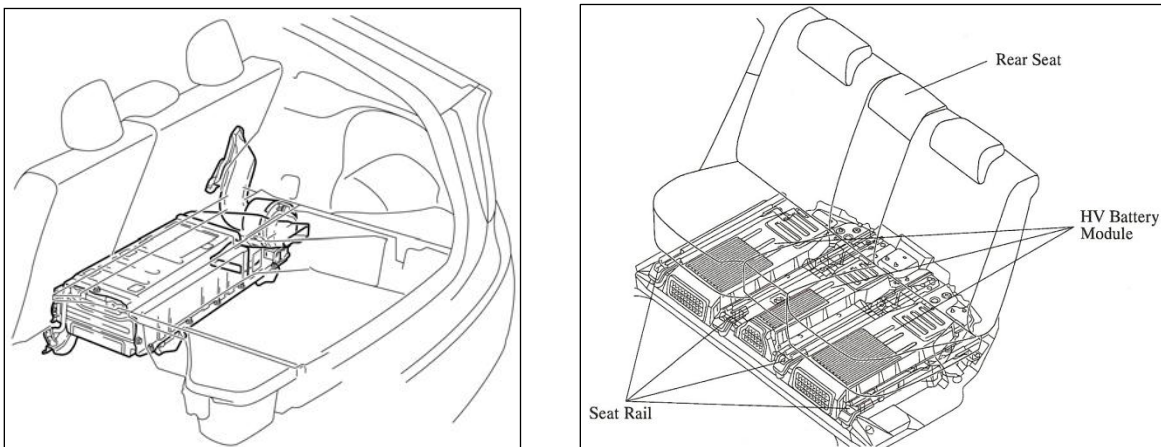

**Figure 29: Battery Pack in Toyota Prius (left) and Lexus RX400h (right) (Toyota Motor Sales)**

A concept called thermal runaway can occur if the batteries were to be severely overcharged or overheated. While the battery is being overheated, the temperature is rising causing the nominal cell voltage to decrease. Charge current then increases exponentially to

increase cell voltage to match the charger voltage (Linden). The most thermal runaway prone types of batteries are Li-ion and NiCd.

Venting is another safety issue for the battery pack. A NiMH cell releases hydrogen gas while venting, and when the hydrogen gas mixes with the gases in the atmosphere potentially explosive combinations could be formed.

## **6.2 Safety Features and Emergency Response Procedures**

Despite the high voltage battery pack and high voltage circuits, HEVs are not dangerous to work on for technicians. The only additional safety measure technicians must take when working on HEVs is wearing specially insulated rubber gloves at all times. Also, the batteries are grounded to themselves. If, for example, an HEV were to be submerged in a body of water, the passengers would be safe to evacuate the HEV by touching the doors, windows, etc. There are three relays that connect and shut down the main circuit in the HEV connecting the batteries to the electric motor/generators. These relays are monitored by the main HEV ECU. The high voltage wires in an HEV are also well marked by color. The orange wires have the highest voltage rating, being over 100 V and yellow wires are between 42 V and 100 V. Also, towing an HEV must be done differently than a conventional vehicle. HEVs must be towed on a flat bed, not with two wheels on the ground. This is because the electric motor/generators would generate electricity if the wheels were being cranked.

## **7. Other Alternatives**

Hybrid electric vehicles (HEV) are not the only new and developing technology striving to achieve superior gas mileage ratings. Car companies like Volkswagen and Audi are marketing their clean diesel turbocharged direct injection (TDI) cars, such as the VW Jetta TDI and the Audi A4 TDIe.

### **7.1 Clean Diesel TDI**

The principle behind direct injection is that it is more effective to directly inject the fuel into the combustion chamber instead of pumping it through the intake manifold first. Direct injection allows the fuel-air mixture to burn more cleanly and efficiently. There are less unburned portions of the fuel because it is being injected directly into the combustion chamber. It will also burn cleaner because TDI allows for the fuel-air ratio to be leaner (more parts air to parts fuel). This allows for carbon emissions to be lowered to 80% of regular internal combustion engines (ICEs). With this said, however, TDI engines have higher NO<sub>x</sub> emissions because of the higher temperature that the diesel burns at. However, there are special catalytic converters to handle direct injection engines' notoriously high NO<sub>x</sub> emissions (Parker).

The 2010 VW Jetta TDI is one of Volkswagen's diesel models. Other models include the Golf and the Touareg. The fuel economy of the Jetta TDI is 41 mpg, compared to the Toyota Prius which is about 50. Hybrids are especially suited for city driving, where their electric motors are efficient in slowpoke traffic. Diesel's fuel economy shines on the highway (Ulrich). Depending on the price differential between gasoline and diesel in your region and whether you spend more of your time in urban or open highway driving, fuel costs in the Jetta TDI may actually undercut the Prius (Editors). The TDI models do not require and battery packs either. Comparing the carbon footprint of the Prius and the Jetta TDI, the Jetta produces 2.4 more tons

per year of carbon dioxide (CO<sub>2</sub>) than the Prius. However, the sulfur dioxide (SO<sub>2</sub>) created from the manufacturing the batteries in the Prius is quite overwhelming.

In terms of performance, the VW Jetta TDI is not speedy but has large amounts of torque. It can generate 177 ft-lbs of torque at 4,250 RPM. It is also very responsive making it an enjoyable driving experience.

## Conclusions

The automotive industry is always evolving and engineering new technologies. Maximizing efficiency and minimizing the harmful effects of vehicles on the environment and society are the primary goals of automotive engineers. The internal combustion engine (ICE) is constantly being tweaked for these reasons. However, the hybrid electric vehicle (HEV) is a new technology being implemented to reach these goals.

The effects and impacts that HEVs have on the environment and society from an engineering point of view were discussed, and the information presented here served to be informative. Important issues were brought up and analyzed, such as current problems with the ICE and the pollution caused by the batteries in HEVs. Almost all aspects of a HEV were scrutinized, such as how HEVs work and what they are, the complexities and impacts of the batteries used in them, and the cost of owning an HEV and how it affects the economy. Safety issues were also discussed as well as other alternative technologies besides the HEV.

There are many key points to highlight from this research. First, it is impractical to compose an opinion about the implementation of HEVs without knowing the full impact of their distribution. Each process and component that is needed to manufacture and market HEVs must be looked upon. It is necessary to analyze every element of an HEV and its individual impact on the environment and society. A proper judgment on the matters concerning HEVs can be made if all of its impacts are taken into account.

Understanding why HEVs are being mass produced and knowing the problems that the ICE is facing are also needed to speculate the concept of HEVs. ICEs have been around for decades, but it is their pollution and demand of oil that is making them harmful. The effects of air pollution, such as global warming, smog, ground-level ozone, and acid rain are all

consequences of some of the chemicals released from an ICE's exhaust into the atmosphere. It is the emission of these harmful chemicals that the HEV aims to minimize by combining a small ICE with an electric motor/generator (M/G). Another important issue to realize is the rapid depletion of oil, a natural resource on the planet. Oil is non-renewable, which is why it's important to use as little as possible in applications where an abundance of oil is needed, such as the automotive industry. HEVs seek to achieve this by maximizing fuel economy with the combination of an ICE and M/G.

The harmful environmental impact of HEVs stems mostly from the high voltage battery pack required to power the M/G. As was mentioned, the voltage of the battery pack depends on the HEV. The important piece to understand, however, is the process needed to manufacture these battery packs. Most all of the battery packs HEVs today used nickel-metal hydride (NiMH) rechargeable battery modules. The use of lithium-ion (Li-ion) batteries in the HEV application is still in preliminary phases. The popular NiMH batteries need the precious metal nickel (Ni) to make one of the electrodes with. NiMH batteries use 50 % of their weight in pure Ni. Ni must be extracted from the ground and processed for it to be useful in the HEV battery application. The procedures for nickel mining, smelting, and refining are extremely harmful to the environment because of the air pollution they create. The initial steps of digging the ores out of the ground release dust and metal particles into the air. Then, the smelting of these ores releases amplitude of sulfur dioxide (SO<sub>2</sub>) into the atmosphere. When SO<sub>2</sub> combines with the naturally occurring gases in the atmosphere, acid rain is formed which is harmful to humans and vegetation. The calculations in section 3.7.1 show that approximately 58.24 kg of SO<sub>2</sub> is released into the atmosphere from the manufacturing of one Toyota Prius battery pack. This is a number that

should not go ignored, because the mass production of HEV battery packs cause more harm to the environment than the original intention of the HEV.

Particulate matter is another instigator of air pollution that nickel mining is a source of. Particulate matter in the atmosphere contributes to smog and increasing the amount of ground-level ozone. The act of retrieving the nickel necessary for one battery pack releases up to 8 kg of particulate matter into the atmosphere.

Regenerative braking was a topic discussed in section 4, and it is important because it affects the performance and handling of the HEV. It is important to understand the forces on the tires and the road and how they affect the way in which the vehicle moves. Regenerative braking is also important to the efficiency of the HEV because the battery pack is recharged in this process.

Another aspect of the HEV is how it affects society in terms of its economics. Major differences between conventional vehicles (ICE powered cars) and HEVs are the cost differences and how they depreciate. The HEV will always cost more than its conventional vehicle counterpart because of the added electrical components. This price difference is called a price premium. To know if the money saved from superior fuel economy will make up the price premium over time it is necessary to know the complete cost of owning an HEV. Factors to consider in figuring this out are how many miles are driven per year, the longevity and replacement costs of the battery pack, insurance, tax incentives, depreciation, and maintenance. Most HEV battery packs last about 10 years with a replacement cost of about \$4,000.00, after the 10 year warranty ends. There are also tax breaks to those who own HEVs, however those tax incentives depend on the tax bracket you fall into as well as how many of that particular HEV



has been sold. Most car companies end the tax incentive after a said amount of their HEVs have been sold.

Safety is another issue that was investigated. The high voltage wires and circuits must be handled properly because there is more of a risk for severe electrocution. Technicians are trained on how to deal with the high voltage components. Specially insulated gloves are worn most of the time while working on an HEV. HEVs must also be towed on a flat bed truck and not with two wheels on the ground so that electricity is not generated. Another important highlight from the section on safety was the concern for the battery pack causing harm if ruptured, overheated, or overcharged. The idea of thermal runaway and venting of the battery pack was addressed because it significantly impacts the safety of the vehicle.

The impact of HEVs on the environment and society was discussed and analyzed, but more importantly, these impacts were found to be negative which is opposite to how HEVs are perceived by the world. There is much more information that can be investigated than the topics covered in this paper. The future of HEVs rests in the hands of the engineers of today, as well as the future of the ICE.

## References

Abuelsamid, Sam. "Greenlings: How do Hybrids and Electric Vehicles Blend Regenerative and Friction Braking?" 18 February 2010. Auto Blog Green. 4 April 2010 <<http://green.autoblog.com/2010/02/18/greenlings-how-do-hybrids-and-electric-vehicles-blend-regenerat/>>.

Baukus, Tara. "The Real Costs of Owning a Hybrid." 23 July 2008. Edmunds. 4 April 2010 <<http://www.edmunds.com/advice/hybridcars/articles/103708/article.html>>.

Baumbach, Gunter. Air Quality Control. New York: Springer-Verlag Berlin Heidelberg, 1996.

Bell, Damon. "How Clean Diesel Fuel Works." 30 November 2006. How Stuff Works. 17 April 2010 <<http://auto.howstuffworks.com/fuel-efficiency/alternative-fuels/how-clean-diesel-fuel-works.htm#>>.

Cheremisinoff, Nicholas P. Handbook of Pollution Prevention Practices. New York: Marcel Dekker Inc., 2001.

Clark, Josh. "Have We Reached Peak Oil?" 8 January 2008. How Stuff Works. 10 December 2009 <<http://science.howstuffworks.com/peak-oil.htm>>.

Cogan, Ron. "Hybrid Synergy Drive Goes Upscale...And Small." Green Car Journal (2009): 22-23.

Connor, Steve. "Warning: Oil Supplies are Running Out Fast." 3 August 2009. The Independent. 11 December 2009 <<http://www.independent.co.uk/news/science/warning-oil-supplies-are-running-out-fast-1766585.html>>.

Datong, Qin, Ye Ming and Liu Zhenjun. Regenerative Braking Control Strategy in Mild Hybrid Electric Vehicles Equipped with Automatic Manual Transmission. Research Article. China: Higher Education Press and Springer-Verlag, 2007.

Deaton, Jamie Page. "10 Top Selling Hybrid Cars." 9 April 2009. How Stuff Works. 25 February 2010 <<http://auto.howstuffworks.com/fuel-efficiency/hybrid-technology/top-selling-hybrid-cars.htm#>>.

Deconstructed: How Car Batteries Work. Science Channel Videos, 2009.

Editors, Green Car Journal. "2009 VW Jetta TDI: Clean Diesel's Answer to the Prius?" Green Car Journal (2009): 45.

Ehsani, Mehrdad, Yimin Gao and Ali Emadi. Modern Electric, Hybrid Electric and Fuel Cell Vehicles. 2nd. Boca Raton: CRC Press, 2010.

End Sites Recycling Processes. 2006-2010. 24 March 2010  
<<http://www.batteryrecycling.com/Battery+Recycling+Process>>.

Fletcher, Seth. "Power Struggle." Popular Science November 2008: 50-55,102-104,104-107.

—. "The Electric-Car Cheat Sheet." Popular Science May 2010: 46-47.

Freudenrich, Craig. "How Stuff Works." 12 2001 April. How Oil Drilling Works. 16 February 2010 <<http://www.howstuffworks.com/oil-drilling.htm#>>.

Fuhs, Allen E. Hybrid Vehicles and the Future of Personal Transportation. Boca Raton: CRC Press, 2009.

Godish, Thad. Air Quality. 3rd Edition. Boca Raton: CRC Press LLC, 1997.

Hall-Geisler, Kristen. "What is the Difference Between the Prius and the Prius Touring?" 9 April 2009. How Stuff Works. 25 February 25 <<http://auto.howstuffworks.com/fuel-efficiency/hybrid-technology/prius-vs-prius-touring2.htm#>>.

Haney, Paul. The Racing and High-Performance Tire: Using the Tires to Tune for Grip and Balance. Springfield: TV Motorsports, 2003.

Heywood, John B. Internal Combustion Engine Fundamentals. United States of America: McGraw-Hill Inc., 1988.

"Hybrid Cars: Auto Alternatives for the 21st Century." 26 March 2006. Computer Control Systems in Hybrids. 18 February 2010 <<http://www.hybridcars.com/components/computer-control-systems.html>>.

Jones, John. "Nickel Powders from the Carbonyl Process." 23 May 2001. AZO Materials. 2 April 2010 <[http://www.azom.com/Details.asp?ArticleID=499#\\_The\\_Nickel\\_Carbonyl](http://www.azom.com/Details.asp?ArticleID=499#_The_Nickel_Carbonyl)>.

Khosla, Vinod and Tim Searchinger. "Crunching the Numbers on Bioenergy Rules." The Boston Globe 23 November 2009: 1.

Koch, John. Inquiry on NiMH Batteries Laura Friedman. 7 April 2010.

Layton, Julia and Karim Nice. "How Hybrid Cars Work." 20 July 2000. How Stuff Works. November 2009 <<http://auto.howstuffworks.com/hybrid-car.htm#>>.

Linden, D. Reddy. Handbook of Batteries. 3rd Edition. McGraw-Hill, 2002.

Northborough, Lexus of. Inquiry on HEVs Laura Friedman. 7 April 2010.

Oblack, Rachele. About.com: Weather. 16 February 2010  
<<http://weather.about.com/od/ozoneinformation/qt/smogcity.htm>>.

Parker, Akweli. "How Direct Injection Engines Work." 2 December 2009. How Stuff Works. 17 April 2010 <<http://auto.howstuffworks.com/direct-injection-engine.htm#>>.

Plint, Michael and Anthony Martyr. Engine Testing Theory and Practice. 2nd Edition. Warrendale: Society of Automotive Engineers, Inc., 1999.

Pulkrabek, Willard W. Engineering Fundamentals of the Internal Combustion Engine. 2nd. Upper Saddle River: Pearson Prentice-Hall, 2004.

Riley, Robert Q. Alternative Cars in the 21st Century: A Personal Transportation Paradigm. 2nd Edition. Warrendale: SAE International, 2004.

Schefter, Kellen. "Power and Efficiency Combine." Green Car Journal (2009): 14-16.

Siuru, Bill. "VW Bluemotion High Efficiency Hybrid SUV." Green Car Journal (2009): 34-35.

Stewart, John. "The Space Race For Pond Scum Superiority Heats Up." Diesel World December 2009: 120-121.

"The Impact of a Nickel Mine in Tanjung Buli, Indonesia." Nickel Mine in Indonesia. The World Group, 27 March 2009.

Toyota Motor Sales, INC. "Technical Information System." 2010. Emergency Response and Hybrid Information. 4 April 2010  
<[https://techinfo.toyota.com/techInfoPortal/appmanager/t3/ti;TISESSIONID=0R34J0kFB10KcHS4J2yhMJ7n0h1CWkzn7QTCyINgkRsbx63DcnpL!-1292824609?\\_pageLabel=ti\\_erg&\\_nfpb=true](https://techinfo.toyota.com/techInfoPortal/appmanager/t3/ti;TISESSIONID=0R34J0kFB10KcHS4J2yhMJ7n0h1CWkzn7QTCyINgkRsbx63DcnpL!-1292824609?_pageLabel=ti_erg&_nfpb=true)>.

Ulrich, Lawrence. "The Most Advanced Engines." Popular Science May 2010: 68-69.

Wiesenfelder, Joe. "Plug-In Electric Cars: Why the Wait?" The Boston Globe 31 October 2009.

Young, Hugh D. and A. Roger Freedman. University Physics with Modern Physics. 12th Edition. San Fransisco: Pearson Education, 2008.

## Appendix A

### Derivation of Savings Formula (Fuhs):

Annual Cost of Gasoline:

Symbols:

D = miles driven per year (mi/year)

G = cost of gasoline (\$/gal)

F = fuel economy (mpg)

C = annual cost for fuel (\$/year)

$$C = \frac{D \frac{\text{mi}}{\text{year}} * G \frac{\$}{\text{gal}}}{F \frac{\text{mi}}{\text{gal}}} \quad (1)$$

Annual Fuel Savings:

Symbols:

S = annual fuel savings from cost of gasoline (\$/year)

C<sub>H</sub> = cost for fuel for HEV (\$/year)

C<sub>CV</sub> = cost of fuel for CV (\$/year)

F<sub>H</sub> = fuel economy of HEV (mpg)

F<sub>CV</sub> = fuel economy for CV (mpg)

$$S = C_H - C_{CV} \quad (2)$$

Combining equations (1) and (2):

$$S = D * G_c \left( \frac{1}{F_{CV}} - \frac{1}{F_H} \right)$$

Chart for Years to Recoup of Various HEVs (Fuhs)

Vehicle	Mileage <sup>b</sup>		Fuel Savings (\$/year)	Price Premium <sup>d</sup> (\$)	Years to Recoup <sup>c</sup>
	CV	HEV			
Toyota Prius <sup>a</sup>	29	50	1,086.21	7,350	6.77
Honda Civic	29	42	800.49	8,145	10.17
Ford Escape	22	29	822.88	8,840	10.74
Lexus RX	20	29	1,163.79	5,060	4.35

<sup>a</sup> Using the Toyota Corolla as a CV

<sup>b</sup> Mileage based on combined city/highway from fueleconomy.gov

<sup>c</sup> Without taking into account tax benefits

<sup>d</sup> Based on MSRP for all vehicles