



WPI



**Development
Design Lab**

Worcester Polytechnic Institute's

Vermicomposting Toilet Manual

2021



By: Elaine Chen, Ruchita Choksey, Danielle Upton, Casey Willis

This manual was adapted from the Global Sustainable Aid Project

<http://www.globalsustainableaid.org>

Table of Contents

Introduction	3
Location Considerations	3
Bill of Materials	4
Toilet Depth Determination	12
Preparing the Base Slab	14
Soak Hole Preparation	15
Waste Bed-Filter and Filter Preparation	17
Flush Mechanism and Lever Assembly	19
Creating Top Slab	25
Assembling 4'X3' Top Slab Mold	25
Filling Top Slab	27
Toilet Structure	28
Creating the Vent Slab	34
Assembling 2'X3' Vent Slab Mold	34
Filling Vent Slab	35
Toilet Enclosure	36
Handwashing Station	37
Water Access Options	37
Earthworm Incorporation	38
Maintenance	38
Taking out Compost	39
Flush Mechanism Replacement	40
Toilet Bowl Replacement	43
Instruction Sheet	45
References	46

Introduction

Hello, our names are Casey, Danielle, Elaine, and Ruchita and we are students at *Worcester Polytechnic Institute*. We are working with the Design Development Lab under Professor Robert Krueger to implement vermicomposting toilets in Akyem Dwenase, Ghana to combat open defecation. The lack of accessibility to public sanitation is spreading harmful diseases such as diarrhea, cholera, typhoid, and dysentery. It is turning into a public health crisis. Since we are not on site, we are producing a manual outlining the construction and maintenance of our design. Our intent is to collaborate with the community to advocate for sustainable sanitation reform and generate independence to continue similar projects in the future.

In this manual, we explain the construction of a single toilet. However if desired a row of toilets could be placed next to each other creating a bathroom complex. The construction would be the exact same process with only one difference. When digging the hole for the Base Slab (found in Preparing the Base Slab) dig the hole larger enough to fit as many toilets as you want next to each other. For example, since one toilet has a width of 3'6" and length of 6'6", if you wanted two toilets together then you would dig a hole that has a width of 7' and length of 6'6".

This manual was also made with the conditions of Akyem Dwenase in mind. In this manual, we have set a certain toilet depth and height that we think would work best for the community and its aggregate water levels. However, if these toilets were to be built in a different town then the water mantle will have to be recalculated for proper use in the Toilet Depth Determination section.



Location Considerations

The pictures below display potential sites for the toilets. We believe that these locations would allow for easy and convenient maintenance. The main concern is to be aware of flooding from nearby rivers. Most sites in Akyem Dwenase are suitable for the toilets as long as they are far from flooding. It is also recommended to place the toilets near buildings that are regularly cleaned and taken care of, so they can be added into these location's maintenance responsibilities. Toilets that are regularly cleaned and checked will be able to last for years, while neglected toilets will have to be repaired more often.







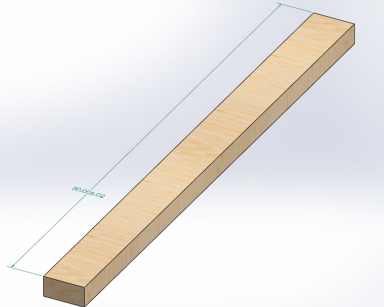

Bill of Materials

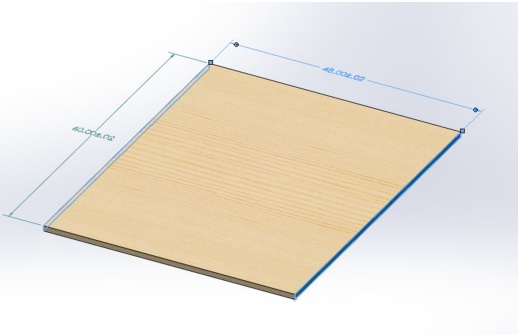
Please note that this Bill of Materials is incomplete and subject to change based on the maker of the toilet's preferences. As seen in the Superstructure section, there are a variety of options that the maker can choose from, resulting in multiple materials lists. Be mindful when budgeting to account for the materials needed in that section.

Item	Quantity
<p>Power Drill and Drill Bits</p> 	<p>1 Power Drill Drill bits larger than size of bent rods</p>
<p>Clamps</p> 	<p>Optional: 4+ to hold two-by-fours when creating molds</p>
<p>Two-by-Fours</p> 	<p>-two 4'2" (1.27m) two-by-fours -two 3'2"(96.52cm) two-by-fours</p>
<p>Cement</p>	





Akyem Dwenase Sanitation 2021 IQP



	
<p>Plywood</p> 	<p>One 5' X 4' (1.52m X 1.22m) plywood sheet</p>
<p>Bent Rods</p> 	<p>8 bent rods</p>
<p>9" (22.86cm) Pie Pan, Nonstick</p> 	<p>One</p>
<p>Plastic Water Bottles</p>	<p>Two</p>

	
<p>Coat Hanger or 1/4" (0.635cm) rebar</p> 	<p>One 9" (22.86cm) piece</p>
<p>3/4" (1.905cm) PVC pipe</p> 	<p>One 9" (22.86cm) long One 10" (25.4cm) long One 2" (5.08cm)</p>
<p>3/4" (1.905cm) PVC Tee</p> 	<p>One</p>
<p>3/4" (1.905cm) PVC elbows</p>	<p>Two</p>

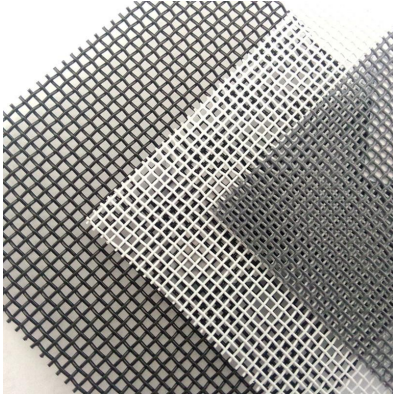
	
<p>1.5" (12.7cm) bolts, both ¼" (0.635cm) in diameter, Nuts and Washers</p> 	<p>Two Bolts Two Nuts Four Washers</p>
	<p>Two Rebar</p>
	<p>One vent pipe 4"</p>

	<p>One vent pipe 8"</p>
	<p>Three Cement bricks</p>
	<p>Large plastic sheet/plastic bag</p>
	<p>Wire mesh</p>

	<p>Knife</p>
	<p>Shovel</p>
	<p>Mosquito netting</p>
	<p>Hay</p>

	Soil
	Earthworms

Section	Materials
Preparing the Base Slab	<ul style="list-style-type: none"> - two two-by-fours 6'6" (1.98m) long - two two-by-fours 3'2" (96.52cm) long - two wooden blocks approximately 3"X3" (7.62cm X 7.62cm) - Wire Mesh - Large rocks - Cement
Soak Hole Preparation	<ul style="list-style-type: none"> - Shovels - Large rocks - Small rocks - Long piece of recycled plastic
Waste Bed-Filter and Filter Preparation	<ul style="list-style-type: none"> - Small Bricks - Large Bricks - Wire Mesh - Mosquito Netting - Hay - Soil/Compost
Flush Mechanism and Lever Assembly	<ul style="list-style-type: none"> - 9" (22.86cm) pie pan, nonstick

	<ul style="list-style-type: none"> - two empty plastic water bottles - wire coat hanger or 9” (22.86cm) piece of ¼” (0.635cm) rebar (or larger) - two ¾” (1.905cm) PVC pipe, one 9” (22.86cm) long one 10” (25.4cm) long - 2” (5.08cm) long ¾” (1.905cm) PVC pipe - ¾” (1.905cm) PVC Tee - two ¾” (1.905cm) PVC elbows - Cement - two 1.5” (12.7cm) bolts, both ¼” (0.635cm) in diameter - two nuts (for bolts) - 4 washers (for bolts) (size can be larger)
<p>Creating Top Slab</p>	<ul style="list-style-type: none"> - Cement - two 4’2” (1.27m) two-by-fours - two 3’2” (96.52cm) two-by-fours - 5’ X 4’ (1.52m X 1.22m) plywood sheet - Clamps - Drill&Drill Bits - Bent rods (8)
<p>Assembling 4’X3’ Top Slab Mold</p>	<ul style="list-style-type: none"> - Cement - two 4’2” (1.27m) two-by-fours - two 3’2” (96.52cm) two-by-fours - 5’ X 4’ (1.52m X 1.22m) plywood sheet - Clamps - Drill - Drill Bits - Bent rods (8)
<p>Toilet Structure</p>	<ul style="list-style-type: none"> - Cement - two 4’2” (1.27m) two-by-fours - two 3’2” (96.52cm) two-by-fours - 5’ X 4’ (1.52m X 1.22m) plywood sheet - Clamps - Drill & Drill Bits - Bent rods (8)

<p>Creating the Vent Slab</p>	<ul style="list-style-type: none"> - Cement - Plastic sheet - Cement bricks - Two 2' two-by-fours - Two 3' two-by-fours - Plywood - Wire mesh - Three 2' rebar - 4" vent pipe - 4" diameter vent pipe with a height of 8"
<p>Maintenance</p>	<ul style="list-style-type: none"> - Pins - Knife - Shovel - Black plastic sheet (a large sturdy plastic bag will do) - Mosquito netting - Hay - Rich soil - earthworms - caulking

Toilet Depth Determination

It is important to consider the conditions of the area in which the toilets are placed. The following steps are to guide users in picking locations and determining waste bed depths in the future.

Step	Image	Description
1		The location should be a sandy or soil bearing area that is well drained.
2		The water mantle must also be taken into consideration. If not already known, the water mantle can be determined by examining the saturation depth after digging a hole. Note: the water mantle height used for consideration should be the one during the wet season.

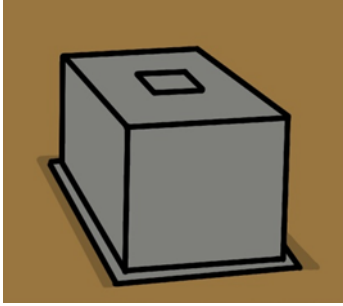
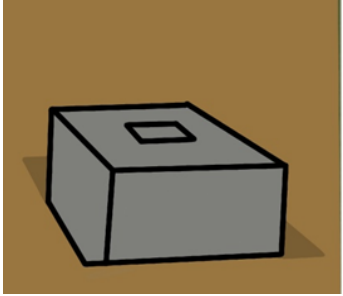
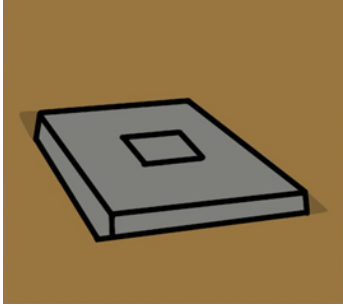
2.a		<p><i>For High Water Mantles:</i> The toilet should be around or above ground level.</p>
2.b		<p><i>For Water Mantles Between Ground Level and 4 ft (1.22m) Below:</i> The toilet can be installed approximately 1' 6" (45.72cm) below the ground.</p>
2.c		<p><i>For Water Mantles Below 4 ft (1.22m):</i> The toilet can be installed at a depth of 3 ft (91.44cm). This is the depth that will be used throughout the manual.</p>

Microflush Toilet Basics

The Microflush Toilet being constructed in the following sections is sustainable and simple to use. To help aid in the construction process, here is a description of how the toilet works. When a user flushes their waste, it drops down approximately 3 ft into what is known as the waste bed. This bed has a filter made of hay, wire mesh, and additional materials that catches any solid waste. Any liquid waste present passes through the filter and lands on the cement base slab. The base slab is slanted slightly so that the liquid travels down and through the pipe located at the bottom, which leads to the soak hole. The liquid waste remains here where a soak hole is (filter made of rocks, plastic and other materials). The solid waste that remains on top of the waste bed is turned into compost by earthworms that digest the waste, removing any harmful toxins. After approximately 2 years, that rich compost can be utilized to grow cacao beans or any other crop! The earthworms are an essential part of the functionality of these toilets. It is very important that

the toilets are built correctly and maintained so that these worms have the proper environment to live in.

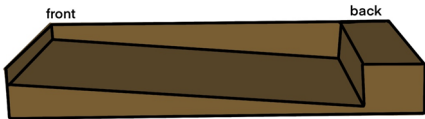
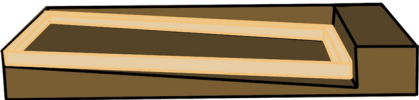
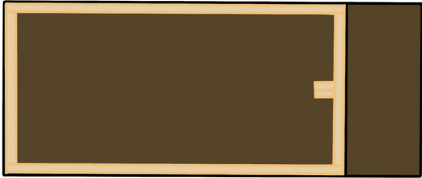

Preparing the Base Slab

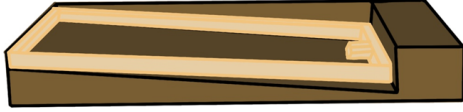
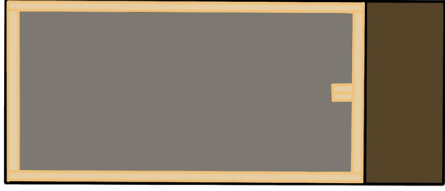
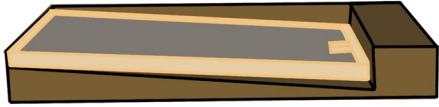
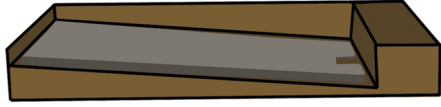

Step	Image	Description
1		<p style="text-align: center;">Gather Materials</p> <ul style="list-style-type: none"> -two two-by-fours 6’6” (1.98m) long -two two-by-fours 3’2” (96.52cm) long -two wooden blocks approximately 3”X3” (7.62cm X 7.62cm) -Wire Mesh -Large rocks -Cement
2		<p style="text-align: center;">Dig Hole</p> <p>First dig the hole. The hole should be a rectangle with a width and length of about 3’6” by 6’6” (1.07m by 1.98m). The bottom of the hole must be dug on a slant. The front of the hole should be the depth determined by the water mantle, so 3 ft (91.44cm) in this case. The back of the hole, as pictured to the left, should be about 8” deeper, resulting in a total depth of 3’8” (1.12m).</p>
3		<p style="text-align: center;">Build Frame</p> <p>The frame of the waste bed is constructed next. The frame is made to fit into the dug hole and is made of two-by-fours. The frame should be 3’6” by 6’6” (1.07m by 1.98m).</p>
4		<p>Place the constructed frame into the hole. Take two blocks, each approximately 3” by 3” (7.62cm by 7.62cm), and place them in the back of the hole, centered as pictured.</p>

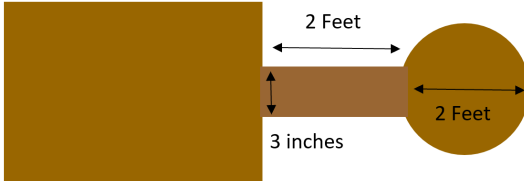
		
5	 	<p>Fill Frame</p> <p>Add wire mesh and large rocks to the bed if those materials are attainable. Then fill the frame with cement.</p>
6		<p>Let the cement solidify before removing the frame.</p>

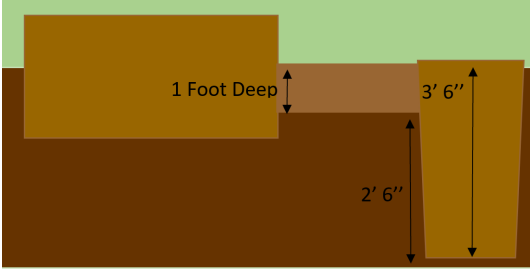
Soak Hole Preparation

Step	Picture	Description
1		<p>Gather Materials</p> <ul style="list-style-type: none"> -Shovels -Large rocks -Small rocks -Long piece of recycled plastic
2		<p>Dig Soak Hole Path</p> <p>First dig a 2' (60.96cm) long path for the pipe (about 3" (7.62cm) in diameter) exiting the waste bed for it to lie. Then, dig the soak hole so that the end of the pipe is at the start of the hole so that the pipe will be emptied into the soak hole. The soak hole should have a diameter of 2' (60.96cm).</p>



<p>3</p>		<p>Dig the soak hole to 2'6" (76.2cm) below the bottom of the pipe path from Step 1. It is important that the soak hole is 2'6" (76.2cm) lower than the pipe's hole. For example, if the pipe sits 1' (30.48cm) below the surface then the soak hole will be 3'6" (1.07m) deep.</p>
<p>4</p>		<p>Make Layers Fill the soak hole with 4 layers. The first layer is of large rocks (~3" (7.62cm) in diameter). Fill the soak hole till there are 6" (15.24cm) left to the surface.</p>
<p>5</p>		<p>The second layer has small rocks (~1" (2.54cm) in diameter). Spread out the small rocks so the large rocks are covered. This layer should be about 2" (5.08cm).</p>

6		<p>The third layer is made of recycled plastic. Cover the rock layer with a piece of plastic, which should also touch and go up the sides of the soak hole a little.</p>
7		<p>Finally the last layer is soil. Fill this layer (which should be about 4'' (10.16cm)) with soil and the soak hole is complete.</p>

Waste Bed-Filter and Filter Preparation

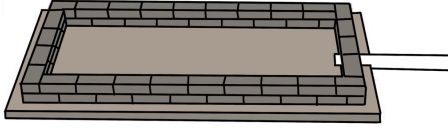
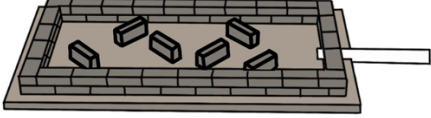
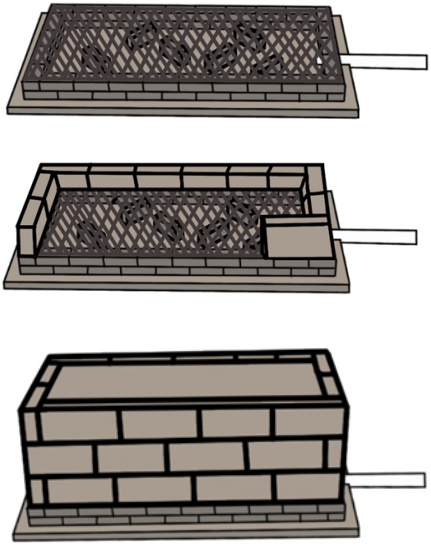
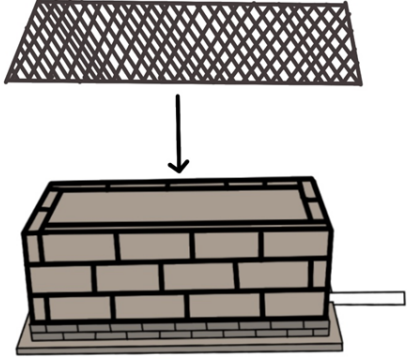

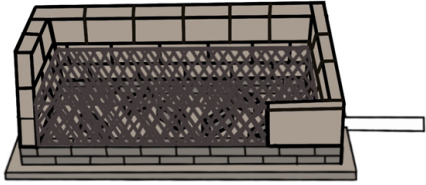
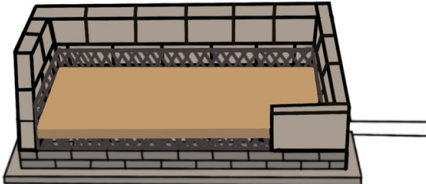
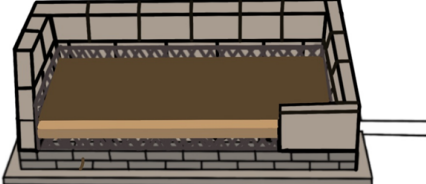
Step	Picture	Description
1		<p style="text-align: center;">Gather Materials</p> <ul style="list-style-type: none"> -Small Bricks -Large Bricks -Wire Mesh -Mosquito Netting -Hay



		-Soil/Compost
2		<p>Build Walls</p> <p>Once the soak hole and pipe path is dug you can begin working on the waste bed. Working 1''(2.54cm) away from the cement edges create a rectangle outline with bricks. Make it two bricks high, so two layers, and build them on top of the pipe opening. Do not block the pipe opening at all. Try to make all the bricks level.</p>
3		<p>Place bricks inside the outline, also two bricks high, to support the next mesh layer. Put the bricks in a similar pattern like the picture.</p>
4		<p>Place Wire Mesh</p> <p>Place wire mesh across the bricks so that the mesh covers the opening and bricks. Cement larger bricks in place on top of where the mesh rests on the smaller bricks to keep it in place. Make sure the mesh is level, and it might help to place temporary bricks in place to keep the mesh still.</p>
5		<p>Place Mosquito Netting</p> <p>The next two layers will be mosquito netting. Place the netting on top of the wire mesh, making sure to cover it and the corners completely. The mosquito netting should go up the edges of the Waste Bed at least 18'' high. Use caulking to stick the netting on the bricks. If you have to use multiple pieces of netting</p> <p>Build up the brick layers till just above ground level (since the base slab is 3' down).</p>



		
6		<p>Place Hay</p> <p>On top of the mosquito netting add a layer of hay, covering the netting fully and reaching all corners. The layer should be 3-4" (7.62-10.16cm) high.</p>
7	 	<p>Place Soil</p> <p>Finally on top of the hay add 3-4" (7.62-10.16cm) of soil or compost, making sure to cover the whole bed and corners.</p> <p>If there is any organic compost the community wants to add to the waste they can do it in this step.</p>



Flush Mechanism and Lever Assembly



Step	Picture	Description
------	---------	-------------

<p>1</p>		<p>Gather Materials</p> <ul style="list-style-type: none"> -9" (22.86cm) pie pan, nonstick -two empty plastic water bottles -wire coat hanger or 9" (22.86cm) piece of 1/4" (0.635cm) rebar (or larger) -two 3/4" (1.905cm) PVC pipe, one 9" (22.86cm) long one 10" (25.4cm) long -2" (5.08cm) long 3/4" (1.905cm) PVC pipe -3/4" (1.905cm) PVC Tee -two 3/4" (1.905cm) PVC elbows -Cement -two 1.5" (12.7cm) bolts, both 1/4" (0.635cm) in diameter -two nuts (for bolts) -4 washers (for bolts) (size can be larger)
<p>2</p>		<p>Attach PVC</p>
<p>3</p>		<p>Drill</p> <p>Drill two 1/4" (0.635cm) holes into the inserted 2" (5.08cm) PVC as shown, or burn holes in the PVC.</p>

4	 <p>Credit: GSAP¹ http://www.globalsustainableaid.org</p>	<p>Using the coat hanger or rebar wire, twist and pull through drilled or burned holes.</p>
5		<p>Using the two empty water bottles, cut off tops and the bottom of one of them. Create a small square notch in the tops of both as shown. The two notches put together should fit the 2" (5.08cm) PVC.</p>
6		<p>Attach Parts</p> <p>Fit the notched water bottles around the wire, and glue to the PVC Tee. It should look as shown. Add in the two longer pieces of PVC on the openings on the top of the Tee.</p>

<p>7</p>		<p style="text-align: center;">Pour Cement</p> <p>Find a stand, or secure the part as shown. Make sure the opening is at the top. Fill with concrete. Tap to ensure there are no air bubbles in concrete.</p>
<p>8</p>		<p>Let dry for 1-2 days before removing it from its vertical position.</p>
<p>9</p>		<p>Once dried, get the bolts, nuts, washers and pie pan.</p>
<p>10</p>		<p style="text-align: center;">Drill Pie Pan</p> <p>Before attaching the pie pan to the concrete weight, it is extremely important that the weight is below the top plane of the pie pan. This way the flushing mechanism will be able to swing shut after being pulled down. The image to the left captures the angle it should be attached at.</p> <p>Mark on the PVC Tee where you are going to drill two holes for the screws. They should be far enough from the Tee section</p>

		<p>that the nut will be able to fit (about 3-4 inches apart). Drill the holes, making sure to go through the PVC Tee and attached PVC pipes. Line up the Pie Pan at the angle needed and mark on the outer edge where you will drill the two holes on the Pie Pan. Drill the hole and make sure that all the holes will line up for the screws. It should look as shown</p>
11		<p>Attach Pie Pan Insert bolts through the PVC and into the pie pan. Place a washer on the bolt's end coming out of the pie pan and lock it with nuts on both sides. For more rigidity, pour epoxy on where the pie pan was attached, or melt excess plastic from water bottles onto this location. You want to ensure the nuts and washers will not move with use.</p>

		
12		<p>Flush Handle Attachment</p> <p>Attach an elbow on the right side of the flush mechanism as shown. Insert a 3” (7.62cm) PVC pipe into this elbow. Attach another elbow on the 3” (7.62cm) inch piece. In this elbow, attach a 4” (10.16cm) piece of PVC. At this point, this end can be used to flush.</p>
13		<p>If the pan is Teflon coated, that is all that is necessary for the finish. If not, it can be sprayed or painted with epoxy paint.</p>

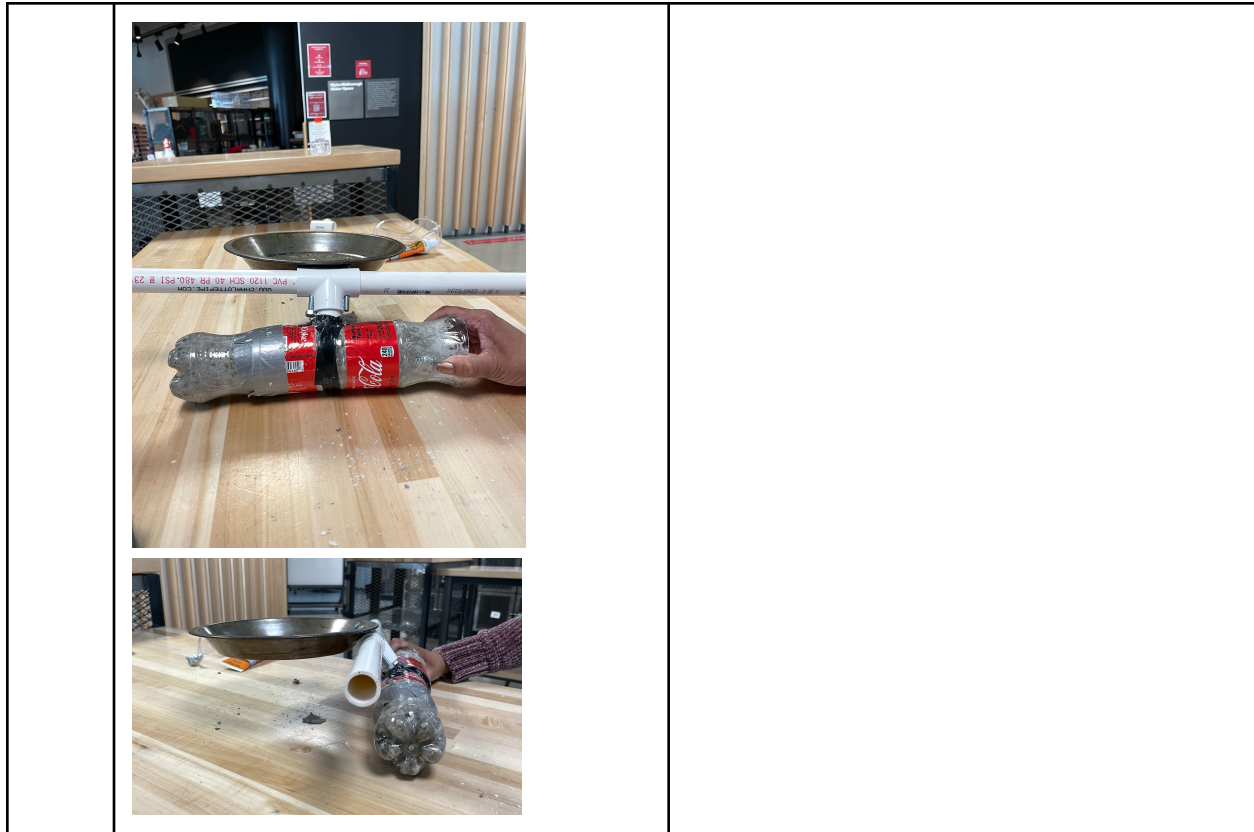

Creating Top Slab

Even though we are calling this slab the “Top Slab”, once construction is complete this slab will actually be the floor of the toilet building. We are calling it the Top Slab here because it is the top of the Waste Bed and will be the final layer of the Waste Bed. Above this slab will be the Toilet and the building surrounding the toilet to create privacy, which we have called the Enclosure.

Assembling 4’ X3’ Top Slab Mold

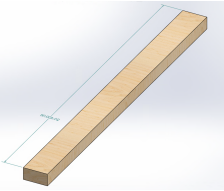
Step	Picture	Description
1		<p style="text-align: center;">Gather Materials</p> <ul style="list-style-type: none"> -Cement -two 4’2” (1.27m) two-by-fours -two 3’2”(96.52cm) two-by-fours -5’ X 4’ (1.52m X 1.22m) plywood sheet -Clamps -Drill&Drill Bits

		<p>-Bent rods (8)</p> <p>This mold will be used to create the top slab. Save the plywood and two-by-fours from this mold to create the 2'X3' (60.96cm X 91.44cm) mold later on.</p>
<p>2</p>		<p>Make Frame</p> <p>Arrange two-by-fours and plywood as shown in the image. Mark drill holes 6 inches (15.24cm) from the edge of each of the two-by-fours. Clamps can be used to keep wood in place.</p>
<p>3</p>		<p>Use the drill bit and drill into the marked locations, ensure you drill through both the two-by-four and plywood. Insert bent rods into the holes to hold the mold in place before cement is poured.</p>

Filling Top Slab

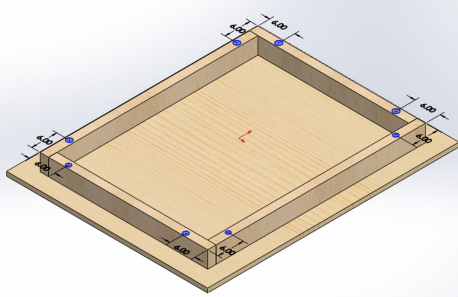
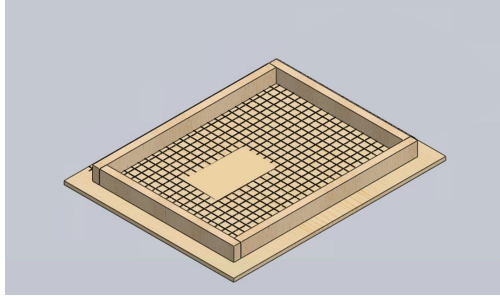
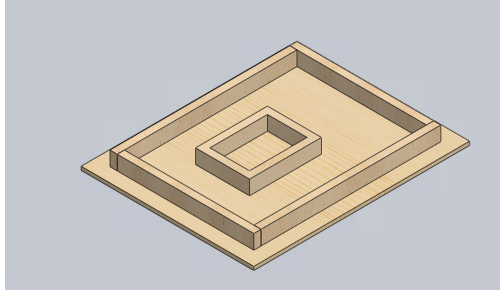
Step	Image	Description
1		<p>Use 4'X3' mold</p> <p>Frame for Toilet Opening</p> <p>To create toilet opening frame, cut two 10'' (25.4cm) two-by-fours and two 15'' (38.1cm) two-by-fours/</p> <p>Using these pieces, create a wooden rectangle. Center this rectangle 1' (30.48cm) from the (longer side) sides of the rectangle and 4'' (10.16cm) from the (shorter side) back of the frame.</p>
2		<p>Wire Mesh</p> <p>Cut wire mesh to fit the frame. Cut a hole in the wire mesh to fit around the smaller two-by-four rectangle.</p>
3		<p>Plastic & Rebar</p> <p>Take out the wire mesh and small rectangle, set this aside for now. Lay down the plastic on the large rectangle frame. The plastic must cover all corners. Put down three pieces of rebar cut 3' (91.44cm). This should fit across the frame. Place the wire mesh on top of the plastic and insert the smaller rectangle into the hole in the wire mesh.</p>

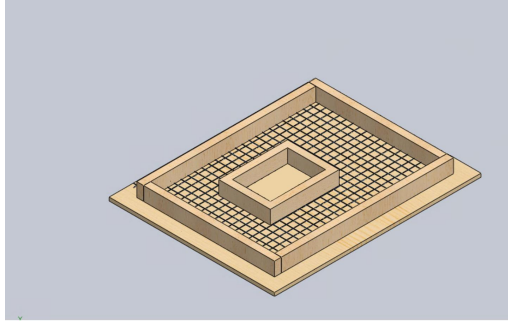
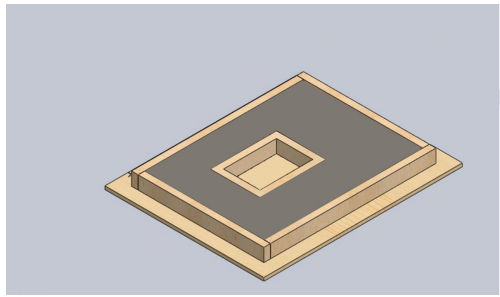
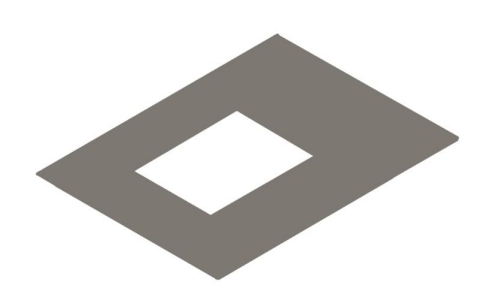
4		<p>Pouring Cement</p> <p>Fill the large frame with cement, making sure to keep the smaller rectangle empty. The cement should have a thickness of 3”-4” (7.62cm-10.16cm).</p> <p>Use a flat hand tool to help smooth out the top of cement.</p>
5		<p>Level Off</p> <p>Use a long slice of wood to smooth out any excess cement in the mainframe.</p>
6		<p>Finished Product</p> <p>Wait 24+ hours to dry. The end result of the top slab would look like this.</p>

Toilet Structure

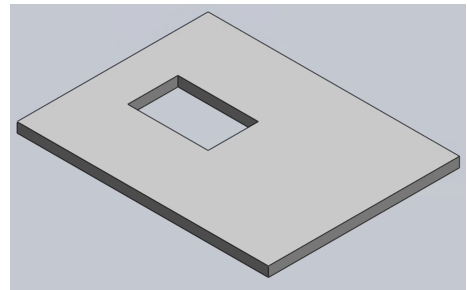
Step	Image	Description
1		<p>Starting the Toilet Structure</p> <p>Put the Top Slab on top of the bricks of the Waste Bed, mostly sealing the bed. Position the Slab so that the hole for the toilet is in the middle of the Waste bed, like in the third picture to the left. There should be a 2’ by 3’ rectangular gap in the back which will be covered by the Vent Slab later.</p>

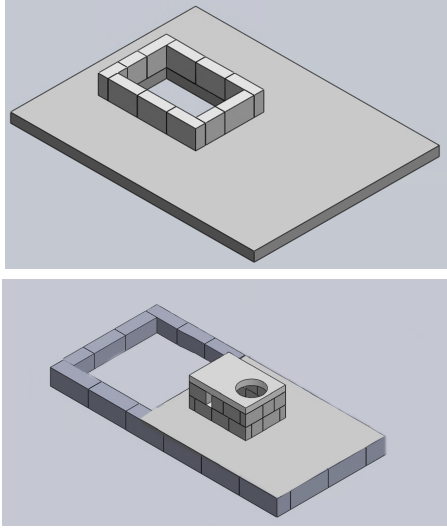
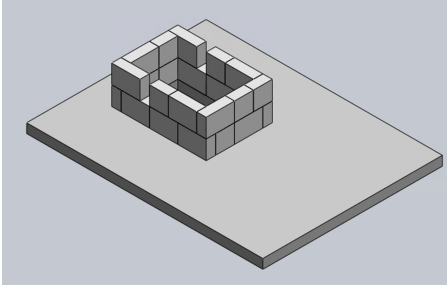
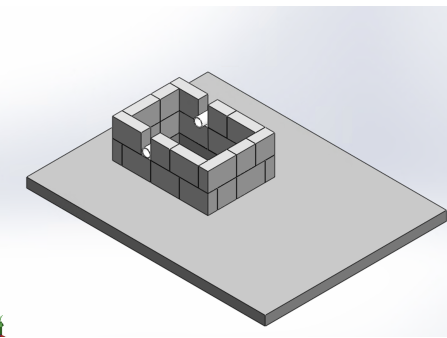
		<p>Lay the first course of bricks around the opening of the hole in the top slab. The outer dimensions of the hole should be 17”(43.18cm) wide and 22”(55.88cm) long.</p> <p>The bucket should be laid evenly on the ground. If the bucket is more than 7” (17.78cm) high, the valve should be installed on the first course of bricks. If the bucket is less than 7” (17.78cm) high, the valve is installed on the second course of bricks.</p>
2		<p style="text-align: center;">Valve Installation</p> <p>Lay two layers of brick around the small rectangular opening(the toilet opening) in the 4’X3’ (1.22m X 0.9144m) slab. In the second layer of bricks, leave openings parallel to each other as shown to the left. Insert two short 4” (10.16cm) in diameter PVC pipes in these openings. Place the flushing mechanism inside. Ensure the pie pan is centered, the counter weight (cement filled water bottles) does not touch the inside edges, and that the flushing handle is parallel to the plane of the pan.</p>
3		<p>Continue laying bricks on the layer of the valve axel and be sure to not put mortar inside the PVC bushings. Continue to lay bricks around the PVC pipe.</p>

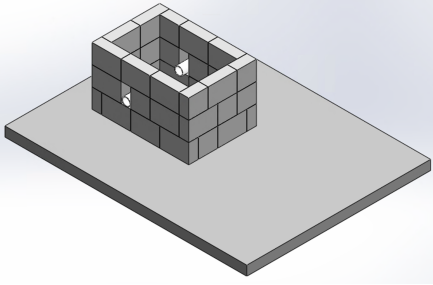
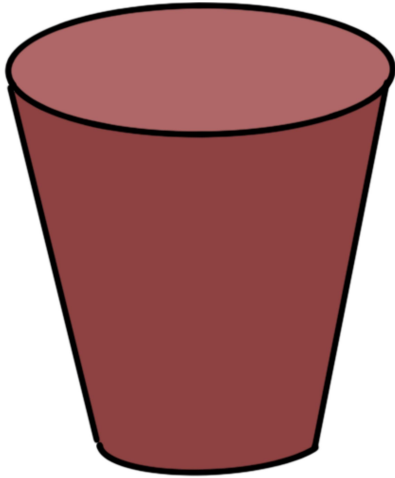
<p>4</p>	 <p>Credit: GSAP¹ http://www.globalsustainableaid.org</p>	<p>Cut the bricks so that they can secure the valve as tightly as possible.</p>
<p>5</p>		<p>Fill the spaces above the hinges with mortar. Be careful not to get mortar on any part of the valve. A piece of plastic can be added inside the axle housing to make a slight adjustment of the valve assembly if necessary.</p>
<p>6</p>		<p>If installed correctly, the pan should rise above the level position. When the bucket is installed, it will force the pan into a horizontal position.</p>
<p>7</p>		<p>Bowl Preparation and Installation</p> <p>The bowl can be made from any of the following: an inverted traffic cone, an appropriately sized plain bucket. The bucket is the easiest to work with and least expensive.</p> <p>Its dimensions should be 7"-9" (17.78cm-22.86cm) high, 9.5" to 10" (24.13cm to 25.4cm) in top diameter, and 6.5" to 7.5" (16.52cm to 19.05cm) in bottom diameter. The bottom of the pail should be cut off before construction.</p>

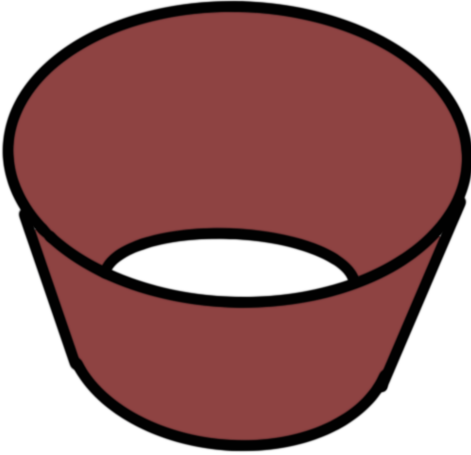
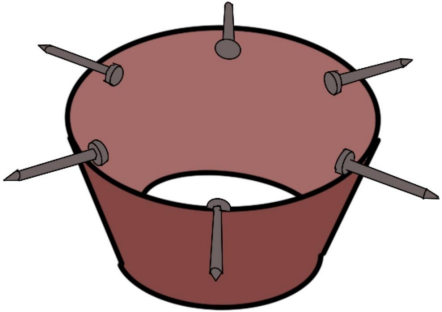
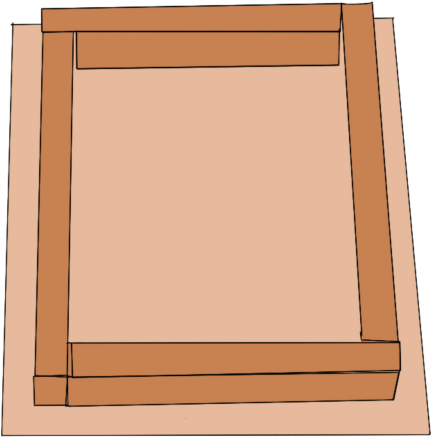
		
8		<p>Nails can be inserted around the top diameter of the widest part of the bucket. These are used to reinforce the adhesion between the bucket and the top slab when it is poured.</p>
9		<p>The wooden form is now prepared to create the top of the toilet structure. The inner dimensions should be 17" (43.18cm) wide and 22" (55.88cm) deep. It should match the outer dimensions of the smaller rectangular hole.</p>

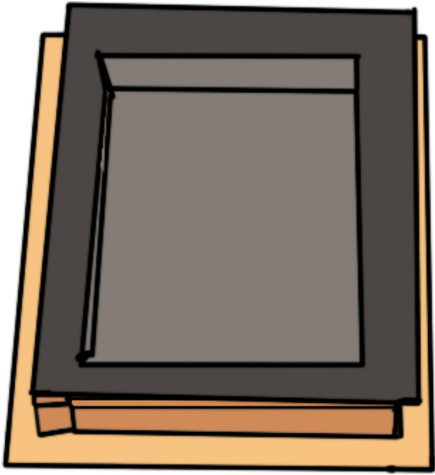
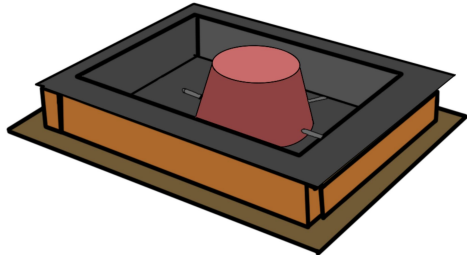
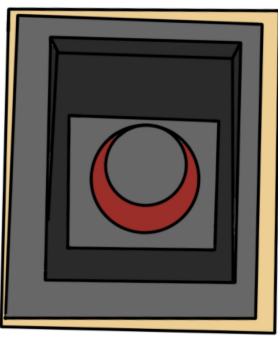
10	 A diagram showing a rectangular concrete slab with a smaller rectangular frame inside it. The frame is being lined with a dark grey plastic sheet. The slab is supported by a yellow base.	<p>Line the small frame with plastic from an earlier slab pour. This allows the removal of the slab when the cement form is dried.</p>
11	  A diagram showing a red bucket placed inside a lined frame on a concrete slab. The bucket is centered on the narrow dimension of the frame. Below it is a top-down view of the bucket inside the frame, showing it is centered.	<p>Put the bucket face down inside the frame. It should be centered on the narrow dimension of the frame and should be situated on the long dimensions so that the center of the bucket matches the center of the pan. This will insure that when the slab hardens and is placed on the toilet structure, the bucket lies directly on top of the pan.</p>

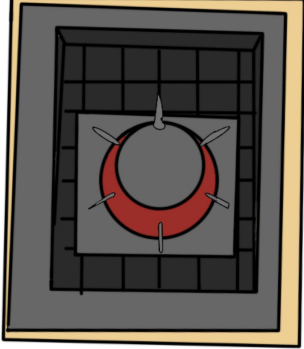
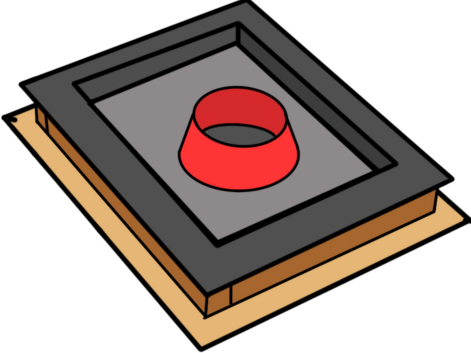
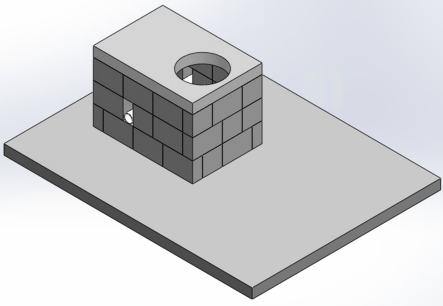
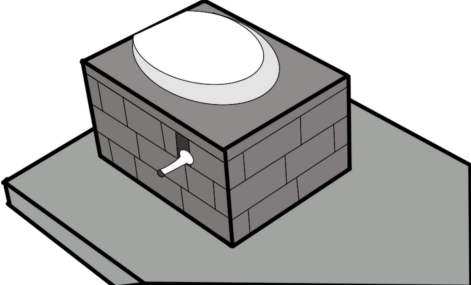
<p>12</p>		<p>When the bucket position is set, place wire mesh around the bucket to serve as reinforcement.</p>
<p>13</p>		<p style="text-align: center;">Pour Concrete</p> <p>Ensure that the slab of the toilet structure is installed on top of the brick wall, the bucket must make contact with the pie pan.</p> <p>Ensure that the bucket will touch the pie pan when placed on the toilet structure. The resulting thickness of the concrete should be not less than 1.5” (3.81cm).</p>
<p>14</p>		<p>When the toilet structure’s slab is dry, carefully remove it from the frame and place it on the brick wall. Use caulking to fill voids in the joint between the toilet structure’s enclosure and top slab to secure it in place. If caulking is unavailable, mortar can also be used.</p>
<p>15</p>		<p>Toilet seat may be placed on the top slab of the toilet structure centered on the rectangular opening.</p>

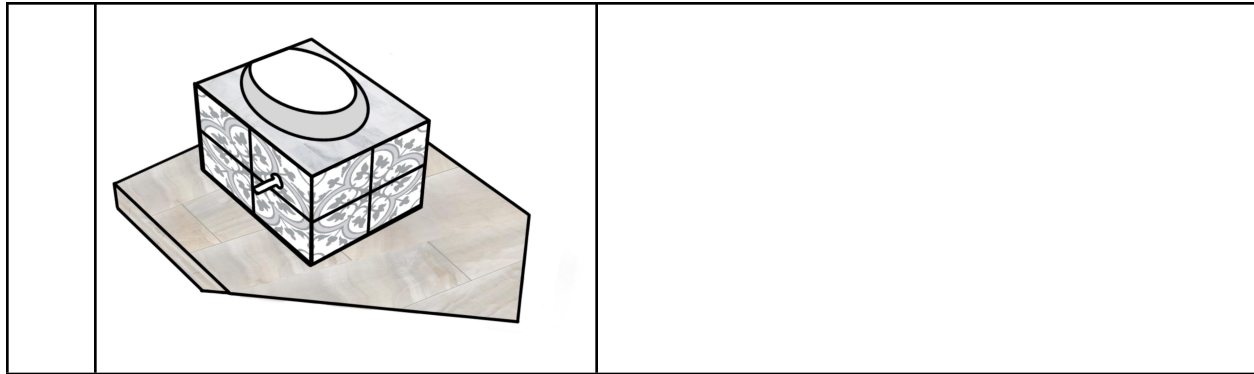

Creating the Vent Slab

This slab will be used with the same frame that was created when making the front slab. However, instead of using that whole frame, the two-by-fours will be adjusted to create a slab roughly half in size. The vent slab will be placed on top of the back of the digester. This is the vent slab behind the toilet. When this slab is lifted, the user will be able to access the digester and remove the compost. This will serve as a lid to where the compost is stored, and will prevent the earthworms or any lingering scents from escaping.

Assembling 2'X3' Vent Slab Mold

Step	Picture	Description
1		<p style="text-align: center;">Adjust Frame</p> <p>Adjust the 4'X3' (1.22m X 0.9144m) Mold, remove the rods from one of the 4'2'' (1.27m) and one of the 3'2'' (96.52cm) two-by-fours. Move them two feet to the left as shown in the image.</p>
2		<p>Using the existing holes in the two-by-fours, drill into the plywood below.</p>
3		<p>Insert rods to secure the two-by-fours.</p>

Filling Vent Slab

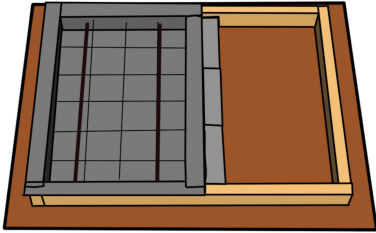
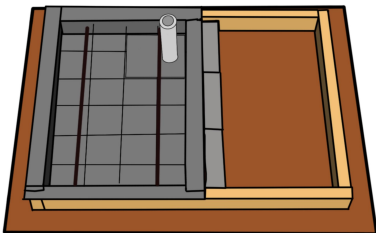
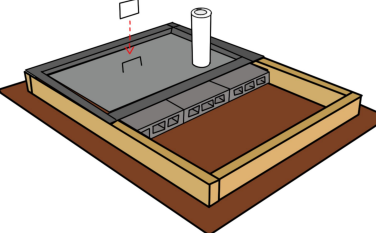
Step	Image	Description
1		<p>Using 2'X3' (60.96cm X 91.44cm) mold above, place reinforcement rebar vertically. Use wire mesh to fill the area.</p>
2		<p>Cut hole in the rebar to fit a 4'' (10.16cm) long and 4'' (10.16cm) diameter vent pipe. Line the pipe with plastic or grease and with lubricant so that it will be able to be removed once the concrete has set.</p>
3		<p style="text-align: center;">Pour Concrete</p> <p>Fill the mold with concrete so it will have a thickness of 2'' (5.08cm).</p> <p>Bend a piece of rebar into a rectangle. This will act as a handle to lift the back slab off of the waste bed for maintenance purposes. It will be inserted halfway into the concrete and left in as it dries. Be sure that enough of the handle is exposed outside from the top of the cement so that it can be firmly grasped. It should be 2'' (5.08cm) high.</p>

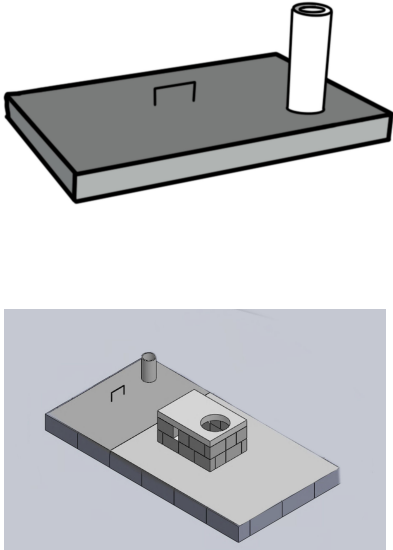
<p>4</p>		<p>Let the concrete harden for 24 hours. Afterward, gently remove the block of concrete from the form. Placement on the top of the waste bed can be done after the facility enclosure is complete. Once firm, a pipe with diameter of 4" (10.16cm) should be placed where the original pipe created a hole. Another option is to install the pipe with a coupling over the short pipe. Once installed, the pipe can be secured to the facility structure using a clamp or bailing wire.</p>
----------	---	---

Toilet Enclosure

Depending on the specifications of the project (singular or multiple toilets) you are working on, this portion is up to the constructor. The toilet enclosure is the superstructure around the toilet and it can be made from any materials that are available. Examples of superstructures



found in Ethiopia from GSAP's project can be found below.¹

Based on community feedback and expected weather conditions, we would encourage the toilet enclosure to have a locking door, thick walls, an angled roof, and mosquito netting between the frame of the door and the roof. Netting allows for ventilation while still allowing sunlight to enter.

Simple alternatives for the superstructure could be a tarp hung from a PVC frame, wood paneling walls, a tin roof, etc. Be mindful of budget, community

preferences, and local weather when deciding what kind of superstructure to build.



Handwashing Station

Inside the superstructure is where the handwashing station will be found. These stations require water delivery which is

outlined in the section below. An example of a handwashing station is shown to the left.³ These stations have a tap above a sink. This sink is attached to a PVC pipe which leads downwards into the toilet's base. The 150 ml (approximately a handful) of water from when the user washes their hands will be drained into the pie pan. This is a critical step because the toilet needs water in the pan to properly flush. In order for this to happen, drill a hole into the base of the toilet where the arrow shows in the graphic to the right. The PVC coming from the sink will go into this hole. Make sure the open end of the PVC is cut so water will drain into the side of the pie pan, not directly in the middle of it.

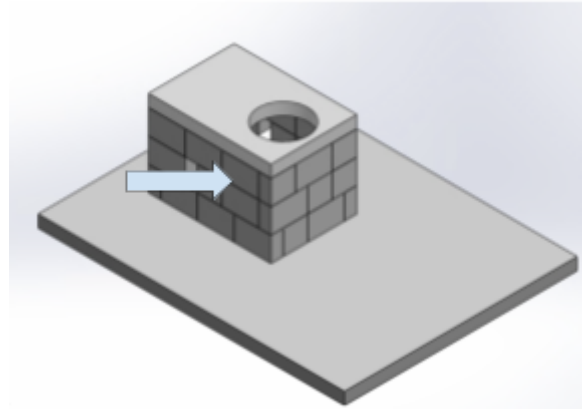

Water Access Options

There are a variety of options to choose from when it comes to water access for the toilets. Consider the site location in relation to water sources, cost of providing water to the facility, and cost of gutter and storage containers. The options are as follows:

Rainfall Capturing:

A gutter can be placed on the back of the roof to capture water. This gutter should run into a PVC pipe attached to a jug, like the image below from GSAP's project in Ethiopia.¹ This allows water to be collected during the monsoon season and stored for later use. The jugs can



either be placed inside or outside the superstructure. Recommended jug sizes range from 10 to 100 or more gallons. The annual expected rainfall for Akyem Dwenase is between 1500-2000 mm (60-79 inches).² This amount of rainfall would provide over six hundred gallons of water a year, which is far more than what needs to be delivered to the toilets. One concern the maker must keep in mind when choosing jug placement is the weight of the water. 100 gallons of water has a weight of over 800 pounds, so jugs should be placed on strong surfaces.

Once the jug's location is chosen, a PVC with a tap attachment can be placed inside the superstructure. An example of a rainwater harvesting system is shown above.³ Keep in mind the tap would have to be lower than the bottom of the jug, that is why the jug in the image above is elevated. This is necessary to allow gravity to propel the water through the PVC to the user. If this option is not feasible the jug can sit outside or inside of the superstructure with an open top. The user will need a small cup to scoop water out of the jug to use when washing their hands. This is the primarily recommended option based on available resources.

Water Main Connection:

If a gutter and water capturing system is not desired, the toilet can be placed near a water source and a tap can be drilled through an exterior wall to deliver water to the user. This option requires continual payments for water delivery charges. Using this option, there could always be the chance a user could leave the tap running which would result in a large water bill and increase the risk of flooding the waste bed. Lastly, this option is not as environmentally friendly or sustainable.

Earthworm Incorporation

The earthworms play a crucial role in the success of the vermicomposting toilet. They are responsible for turning the solid waste into compost. Any type of earthworm can be used. They can often be found in leaf worm litter or other areas of moist soil. Each toilet needs 100 worms before any use. If 100 earthworms cannot be found for each toilet, earthworms can be purchased. The earthworms will be placed in the waste bed of the toilet. It is important that they are not added until the toilet has been used for 1 week. Add 100 earthworms to the waste bed by either opening the vent slab and releasing them in the waste bed or by using the flushing mechanism to open the toilet hole and drop them in. However, it is important to note that the environment must remain suitable for the earthworms. This means that the waste bed cannot be overwhelmed with waste and cannot have any materials such as detergents or soap that would harm the earthworms. One sign of overuse or failure of earthworms in the toilets is an unusually bad smell or a build up of flies⁴. This smell and fly buildup is because the worms are not able to digest the waste. If this occurs, try adding additional 50 earthworms, as well as banana peels and other compostable materials. If the issue still persists after this, consider emptying the compost and starting over with new soil and earthworms.

Maintenance

The success and life span of these toilets relies on how well the toilets are maintained. To ensure a long lifespan, appoint one person to be in charge of holding the keys to the toilets, the key holder. Their responsibilities include checking to ensure all parts are fully functional as well as maintaining cleanliness. It is recommended that the key holder visit the toilet at least daily to clean the toilet as well as check in on all other parts. A deep cleaning should occur once a week. If maintenance is required on one of the parts, the key holder should fix the part or find someone to fix it. Upkeep is essential. The key holder is also responsible for locking the toilets each night and unlocking them each morning. They may choose to delegate this task to someone if an issue arises. A set time should be determined for the opening and closing of the toilet. Hours should be consistent and known by the community.

It is also recommended that funds are available for any maintenance issues that arise. One option is to have users pay a small fee for each use of the toilet. Someone will need to be

designated to sit outside each of the toilets and collect these funds daily. This money will then be saved and used for maintenance issues that arise in the future.

Taking out Compost

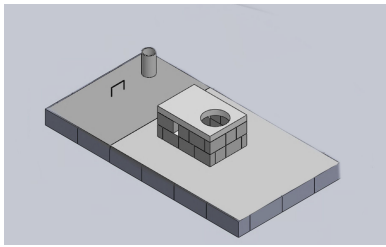
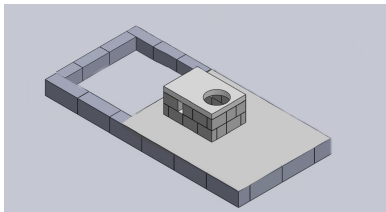
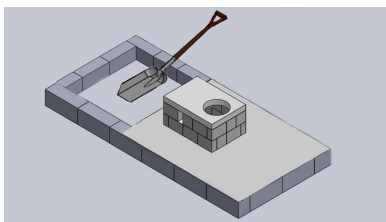
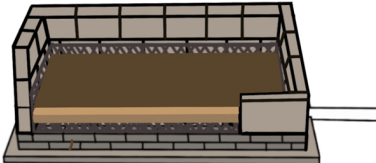
Step	Picture	Description
1		Compost can be removed from the back of the toilets every 2 years. Before removing make sure that the toilet is not used for 10 days. If this is not possible, make sure to store the materials properly and have them composted before using in farming or selling.
2		<p style="text-align: center;">Remove Vent Slab</p> <p>Cut the caulking that is connecting the vent slab to the structure with a knife to take off the slab. Place the slab on the ground near the toilet. Be careful not to break it as you will be putting it back once the process is over.</p>
3		<p style="text-align: center;">Take Out Compost</p> <p>Shovel the upper layers of compost out of the structure and move it away. Do not push too hard as you do not want to break the mosquito or mesh layers.</p>
4		<p style="text-align: center;">Dry Compost</p> <p>Put the shoveled material to dry out on a black plastic sheet (the black color will absorb heat quicker). Make sure the compost is fully done drying and then use it for farming.</p>
5		<p style="text-align: center;">Check Netting</p> <p>In the Waste Bed check the mosquito netting and see if it is still in place. If not, remove all the layers and put two new layers of mosquito netting in place. Add a layer of hay and then a layer of rich soil. Finally add the earthworms back into the waste bed. The compost taken out of the bed can be used to restart the process if wanted.</p>

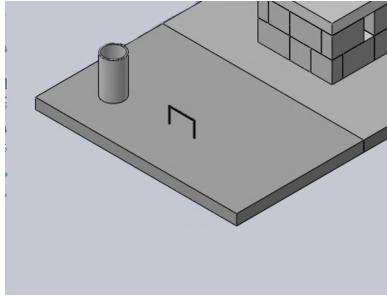
6		<p style="text-align: center;">Return Vent Slab</p> <p>Put the Vent Slab back on top in its original place and apply caulking again, like in Step 4 of Filling Vent Slab.</p>
---	---	--

Flush Mechanism Replacement

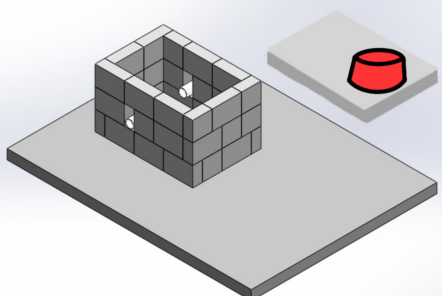
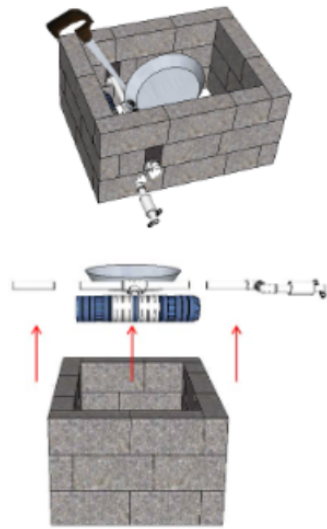
1		<p style="text-align: center;">Remove Slab</p> <p>Use a knife to cut the top toilet slab from Step 14 of Toilet Structure off and carefully place it to the side, not damaging the toilet bucket/bowl.</p>
2	 <p style="text-align: center;">Credit: GSAP¹ http://www.globalsustainableaid.org</p>	<p style="text-align: center;">Cut PVC</p> <p>Remove the Flushing Mechanism by cutting the 9" (22.86cm) PVC pipe and lifting the parts out.</p>

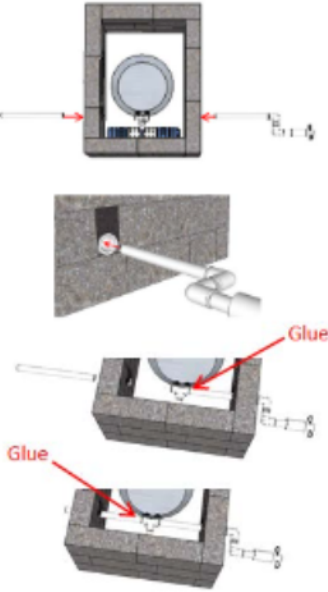
<p>3</p>		<p>Create a new Flushing Mechanism (use Flush Mechanism and Lever Assembly) but do not attach the 9''(22.86cm) pieces of PVC to the T-piece.</p>
<p>4</p>	 <p>Credit: GSAP¹ http://www.globalsustainableaid.org</p>	<p>Put the pie pan/weight/PVC-T into the hole and push the 9'' (22.86cm) PVC pieces through the gaps in the brick where they would normally sit.</p>

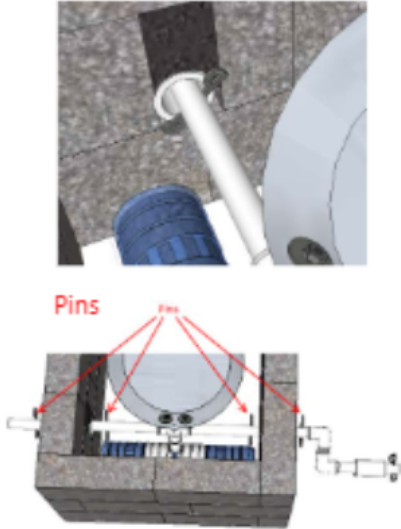
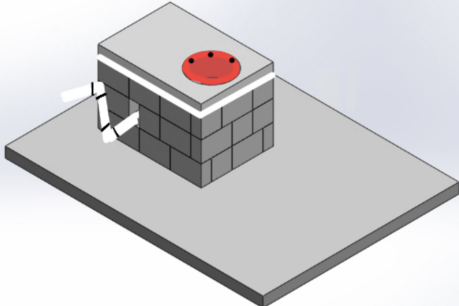
<p>5</p>	 <p>Credit: GSAP¹ http://www.globalsustainableaid.org</p>	<p>Glue the 9” (22.86cm) PVC pieces to the T-piece and fix the handle so it will stay in place. Put pins in the PVC pipe section, both close to the inside the bricks and outside to prevent them from sliding. Finally make sure the flap can move properly and with no resistance.</p>
<p>6</p>		<p>Re-attach Slab</p> <p>Put the top toilet slab back on top of the structure and re-caulk the joint as done during building.</p>

Toilet Bowl Replacement

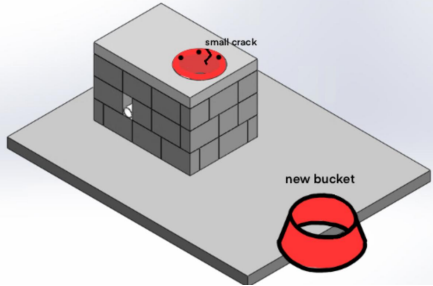

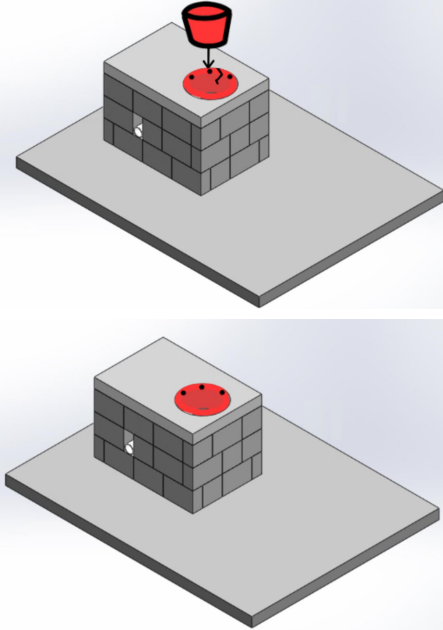
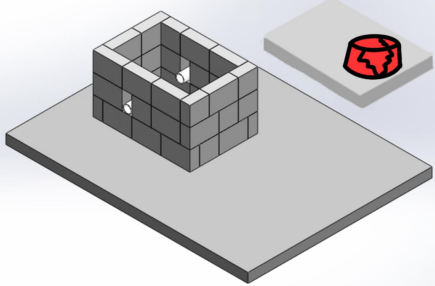
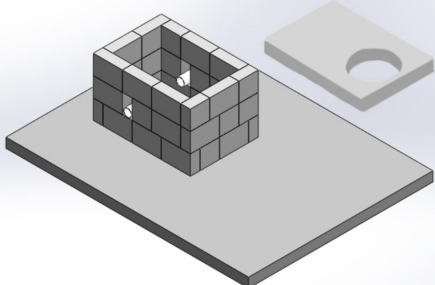
<p>1</p>		<p>If There Is A Small Crack In Bucket:</p> <p>If the bucket just has a small crack but is mostly undamaged then it is an easy fix. First clean the bucket broken bucket and let it dry. Bring a bucket to replace the broken one and check that it fits inside the broken bucket, particularly at the top and bottom. If the fit is good, put caulking on the inside of the old bucket and the outside of the new one and fit the new bucket in. It will be good to put something heavy inside the bucket to make sure the bucket stays</p>
----------	---	---

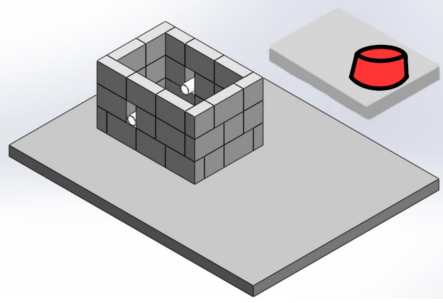
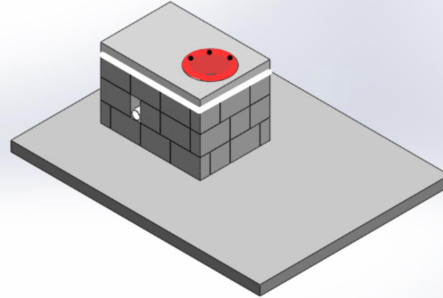
		<p>in place while drying.</p>
<p>2</p>		<p>If Bucket Is Broken: If the bucket is very broken and must be removed the process is longer. Use a knife to cut the caulking connecting the top toilet slab to the bricks. Put the slab on the ground upside down with the bucket above the slab. Make sure you have a new bucket the same exact size and width as the original bucket (so the bucket fits into the slab and is the correct height from the flush).</p>
<p>3</p>		<p>Clear Concrete Carefully peel the bucket away from the concrete and take out all the nails from the concrete that originally held the bucket in place.</p>

4		<p>Install New Bucket</p> <p>Fill in the holes from the removed nails and pins. Put the new bucket in the space where the old bucket was. Once you are sure it fits properly add as much caulking as you want to the area where the bucket touches the concrete to make sure it stays in place. Put some pressure on the bucket while drying to have a tight fit.</p>
5		<p>Reattach Slab</p> <p>Put the slab back to its original place and recaulk the slab to the bricks as done during building.</p>

Instruction Sheet

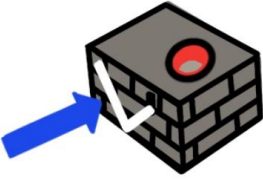
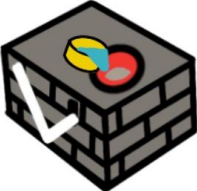
User Instructions

	<p>Sit or squat over the toilet opening.</p>
	<p>Leave paper and waste in the toilet. Flush using handle.</p>
	<p>Use water to wash hands with soap. Pour used water into toilet for next user.</p>
	<p>Use spray or brush to remove any clinging waste or paper from toilet.</p>
	<p>Please follow instructions and clean each day!</p>

References

1. Global Sustainable Aid Project (GSAP), <http://www.globalsustainableaid.org>
Permission to use construction photos via Libby Gladding
2. World Bank Group. (2021). *Ghana Climate Data : Historical*. climateknowledgeportal. <https://climateknowledgeportal.worldbank.org/country/ghana/climate-data-historical#:~:text=Ghana%20has%20three%20hydro%2Dclimatic,1500%20mm%20and%202000%20mm>.
3. *Microflush Toilet-Maker's Manual: STEP-BY-STEP GUIDE TO CONSTRUCTING YOUR MICROFLUSH TOILET*. Global Sustainable Aid Project, Catholic Relief Services, USAID.
4. McBride, A., Muturi, C., Githiri, D., Parker, J., OXFAM, Bill & Melinda Gates Foundation, & UNHCR. (2017). *Tiger Worm Toilets*. <https://www.humanitarianlibrary.org/sites/default/files/2018/12/Tiger%20Worm%20Toilets%20Best%20Practice%20Guidelines%20%28Oxfam%20and%20UNHCR%202017%29%20PDF.pdf>