

The Palace of Monarch: Chinese VR Horror Puzzle Game

by

Bolin Zhu

Jing Xiong

A Thesis

Submitted to the Faculty

of the

WORCESTER POLYTECHNIC INSTITUTE

in partial fulfillment of the requirements for the

Degree of Master of Science

in

Interactive Media and Game Development

April 26th, 2018

APPROVED:

Jennifer deWinter, Advisor

Brian Moriarty, Reader

Jeffrey Kesselman, Reader

Ralph Sutter, Reader

Table of Content

<i>The Palace of Monarch: Chinese VR Horror Puzzle Game</i>	1
Table of Content	2
1. Introduction	5
1.1. Game Type/Genre	6
1.2. Overview	6
2. Experience Design	7
2.1. Horror Experiment	7
2.1.1. Story for Experiment	8
2.1.2. Trigger Design	8
2.1.3. Level Design	10
2.1.4. Vest	11
2.1.5. Oximeter: Apple Watch	11
2.1.6. Result	12
2.2. Story	12
2.3. Horror Development	14
2.3.1. Isolation in horror games	14
2.3.2. Tension in horror games	15
2.3.3. Uncertainty in horror games	15
2.3.4. Lingering fear in horror games	16
2.3.5. Claustrophobia in horror games	16
2.3.6. Being haunted in horror games	17
3. Level Design	19
3.1. Walkthrough	19
3.1.1. Intro Scene	19
Chapter Name: The Letter	19
3.1.2. Tutorial Level	21
Chapter Name: Before Nightfall (see Fig. 3.1)	21
3.1.3. Second Level	23
Chapter Name: Upon The Entrance (see Fig. 3.2)	23
3.1.4. Third Level	25

Chapter Name: Mr. and Mrs. Yang (see Fig. 3.3)	25
3.2. Characters	27
4. Environment design	30
4.1. Architecture Inspiration	30
4.2. Map Design	33
4.3. Light	34
5. Puzzle design	38
5.1. Symbolic Representation: Maple/Red Tree	38
5.2. In-Game Objects	39
5.3. Symbol Interpretation & Recognition	40
5.4. Connections of Objects to Puzzles	41
6. Technical Development	43
6.1. Architecture	43
6.1.1. Inspiration	43
6.1.2. Cyclic Dungeon Generation	45
6.2. Grammar Definition	46
6.2.1. Graph Grammar Design	46
6.2.2. Atomic Pattern Design	47
6.3. Syntax	51
6.3.1. Pattern Integrity	51
6.3.2. Levels and Spaces	53
6.4. Code Conduction	54
6.4.1. Object Structure	54
6.4.2. Pipeline Structure	57
6.4.3. Hierarchy	59
6.5. VR Movement	61
6.5.1. Reticle Use in Virtual Reality	61
6.5.2. Teleporting	64
6.5.3. Point and Walk	65
6.5.4. No Movement	66
6.5.5. Xbox Controlled Movement	67
6.6. UI Optimization	68
7. Testing	70

8. Post Mortem	77
Project overview	77
Key Accomplishments	77
Things Could've Done Better:	80
Future development:	81
References:	84
Appendix:	87

1. Introduction

Enter *The Palace of the Monarch* to experience Chinese horror and mystery in a fully realized virtual reality game. Follow a trail of cryptic letters and portraits, solving many unique puzzles in ever more extraordinary places—this is a mysterious journey where knowledge meets myth. This fully immersive game asks the player, in the role of the first son of House of Lin, to return to an ancient palace to fulfill solve a mystery. This game is unique to Western markets, bringing Chinese culture, history, writing, and horror sensibility and coupling this with a carefully designed and paced mystery that is told through discoveries in the game world. Ultimately, players will unveil the hidden secrets of the palace. Through research on environmental storytelling, human computer interaction, and game puzzle design, we want to provide the game with fascinating and immersive VR experience.



Figure 1.1: Game Poster

1.1. Game Type/Genre

Game Type: Puzzle/Narrative/Horror

Graphics: 3D & VR

Platform: HTC Vive/Oculus Rift

Target Audience: Age 10-35, puzzle game lover, VR game lover

1.2. Overview

We start off with experience design in Chapter 2 where we go through horror development based on a horror experiment we had prior to *The Palace of Monarch*. In order to deliver horror experience, we manage to write up a brief story throughout level design in Chapter 3 as well as some details about characters. Next, we get to artistic perspective of how the game should be visualized in Chapter 4 Environment Design. As we are building a puzzle game, we go over puzzles as environmental objects in the game in Chapter 5 Puzzle Design. Then, we talk about how we conduct the design using technology and how we deal with challenges when using them in Technical Development (Chapter 6). Lastly, we list out the tests we held and the iterations of improvement from the tests in Chapter 7. Post Mortem then concludes the report.

2. Experience Design

The experience design of this game is around East Asian horror. Horror has been developed in multiple Chinese horror stories and novels in various media, but is strangely underdeveloped in games. As a result, we decided to pioneer development in games in typical eastern Asian horror, that is, psychological horror. Such horror usually starts off with an ordinary scene that is ordinary enough for you to feel so natural and blended in. Thus, we definitely need an environment that builds up the atmosphere of traditional Eastern Asia: a Chinese palace particularly in this case. Then the small environmental changes happen along the progress gradually, ignorable but overt enough to be noticed. That is, the environmental design and in-game objects would change slightly based on the player's behavior. Started off with a research on horror experiment prior to this project, we studied horror in virtual environment and learned a couple of ways to balance horror and gameplay. In the end, the player should expect to feel trapped, isolated, and threatened by surroundings, but only a few physical entities may recall the threat and fear.

2.1. Horror Experiment

This project presents an experiment testing the key elements in a horror game, most warrant further investigation as a means to control the level of fear in such games. The experiment is a part of a human computer interaction course project prior to *The Palace of Monarch*, ultimately designed to support the game level design for virtual reality horror game. By this means, it is hoped to provide an enhanced gaming experience whereby periphery and third party wearable device is conducted in real-time according to the player's affect response

and emotional state. Results indicate that periphery has the potential to influence the intensity of the player's fear response while playing a horror game. Evidence is also presented that supports the integration of event triggers and real-time participant heartbeat rates into an experimental design to gather unbiased, quantitative data that can be associated with qualitative emotional response.

2.1.1. Story for Experiment

The story for this game is quite simple, collect the five books. These books are scattered across the level, and the players have to find them; however there is a catch. We also tell players of something hunting you in the environment and to avoid this "thing" at all costs. In reality, there is nothing harmful in the environment, just the player's perception of the danger. Now of course, through the level, you hear footsteps, voices and even see full body apparitions. Through the visuals and audio, we make the player feel they are not alone, even though they actually are.

2.1.2. Trigger Design

The trigger design is very important for both the experience and the data collected. There are different types of triggers, one containing only audio, ones with only visuals or one with both involved. The picture, Fig. 2.1, shows where all these triggers are and how they ended up in the final game.

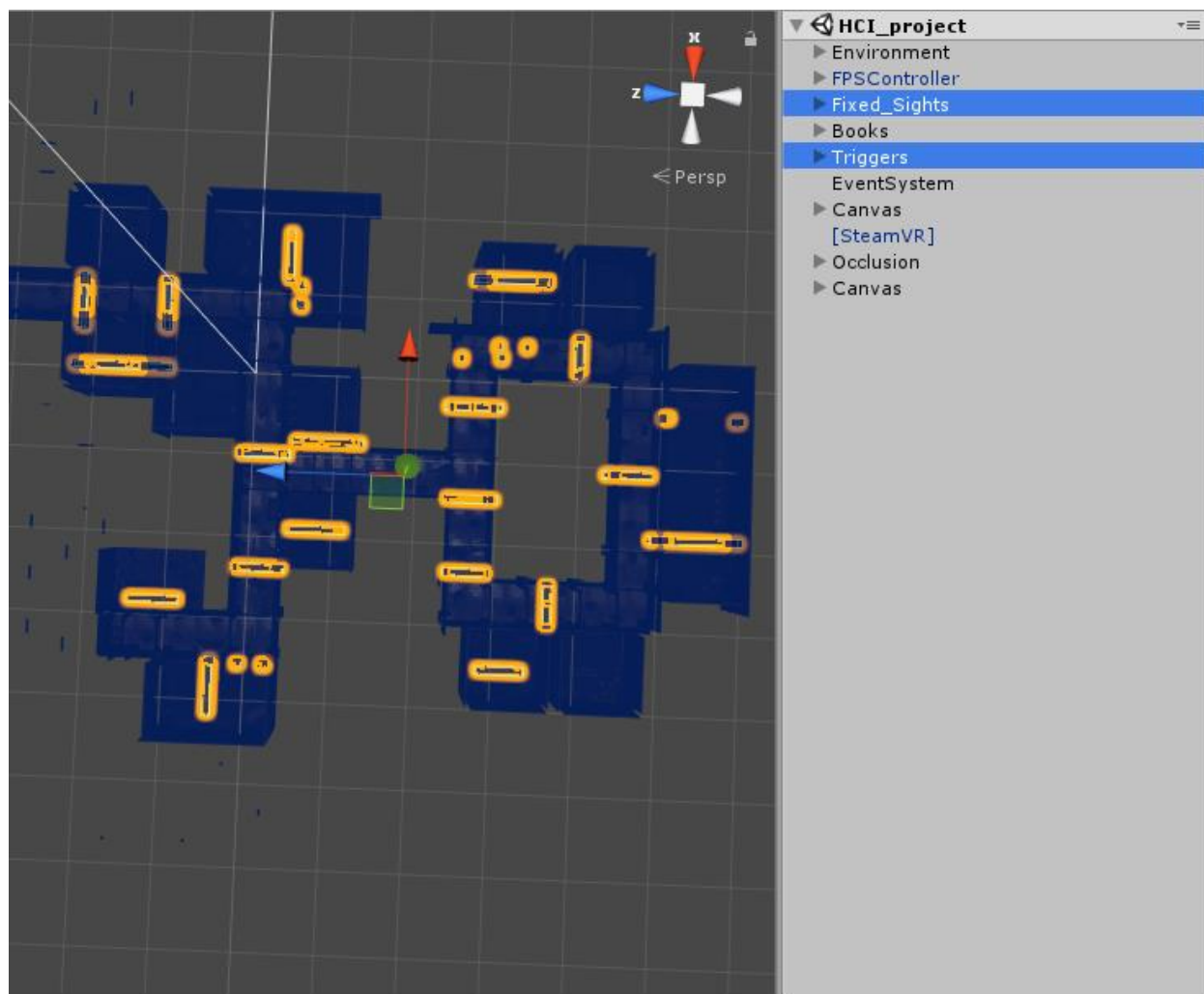

Figure 2.1: Trigger Design of Horror Experiment

When placing the triggers, we had to make sure they were not in the wrong place. A badly placed trigger, would kill immersion and would ruin the experience of the game. Multiple tests were performed of us going through the level, making sure each trigger were well placed as well as made the player jump in a sense. After some tweaking, the triggers were finalized and were confirmed to increase heart rates.

2.1.3. Level Design

Creating a horror based level, the level design needed to support this (see Fig. 2.2). With dim lighting, to the overall environment looking destroyed, this all had to come together to make a complete game. With the overall layout, we want to give the player the feeling of choices in a linear experience. With the multiple rooms and fork in the hallway, it gave the players a choice to go straight or left, but in reality, they would make both choices later on.

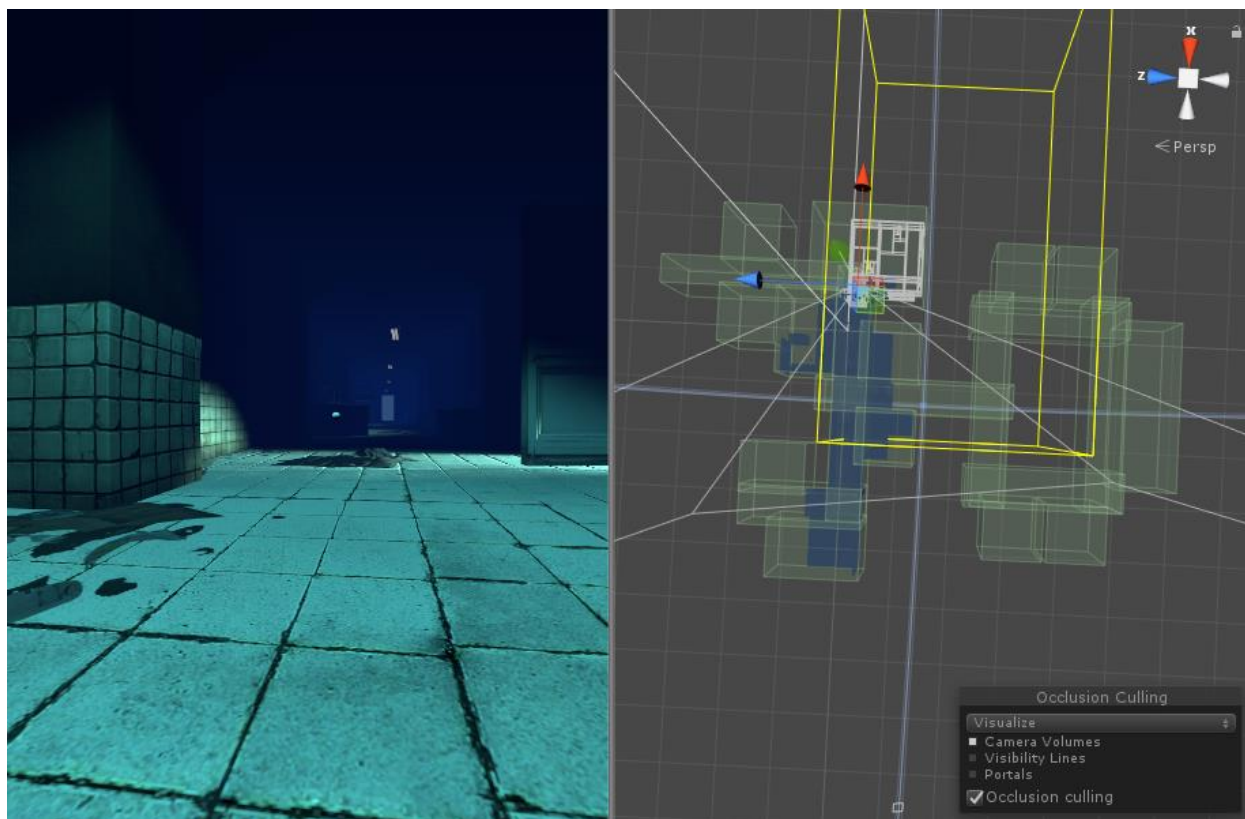

Figure 2.2: Game Scene (left) and Unity Editor Scene (right)

2.1.4. Vest

Throughout the experience of working with technologies we have never played around with before, the gaming vest, shown in Fig. 2.3, was one of interest. From initial tests, to the ultimate decision to remove it from the final project and tests, the gaming vest was a robust piece of equipment but in the end, did not suit our needs.

The 3rd Space Gaming Vest was created by Tngames [27], mostly for first person shooter applications. Suited with eight active zones, four in front and four in back, it allowed the player to be immersed in the game using a high powered air

compressor. When triggered, the vest would expand one of the eight active zones, giving haptic feedback to the player, through the burst of air in the chest or back.



Figure 2.3: 3rd Space Gaming Vest [27]

2.1.5. Oximeter: Apple Watch

Due to all of this immersive technology, we have the oximeter, Apple watch in our case, to measure the heart rate of the player during the experience. From the one minute “Peaceful” scene to the panic inducing version of the scene, we are looking at the differences in the heart rates. Through the graphics, sound, virtual reality headset, and feedback vest, we hope to provide a close to real life experience inside this virtual reality, with the oximeter to measure this.

2.1.6. Result

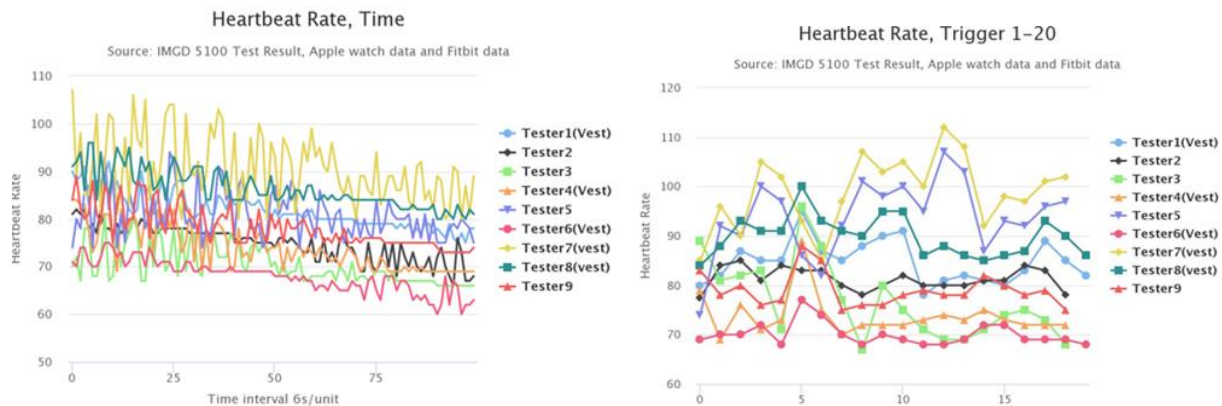

Figure 2.4: Heart Rate vs Time Elapse (left); Heart Rate vs Trigger (right)

Through the Fig. 2.4, we found out that players are much more sensitive or scared with higher heart beats when audio effects and peripheral images occur during gameplay. Our questionnaire also shows that claustrophobia plays an important role in this kind of horror games. With these results, we are able to advance to create a game to deliver similar experiences for players.

2.2. Story

A felicitous story provides the backbone of the whole design. The player, as the successor of Lin's Palace, is told to investigate Yang's Palace to find out the absurd death of the whole palace, probably including your aunt who has been sold to this area years ago when the family was really poor. When the player climbs up onto the top of the mountain where Yang's palace is, he meets a girl who claims to a guide of this area. She claims to be one of the survivors, but who knows. With the girl's guidance, the player finds found the key to the palace. After entering the palace, the door closes behind somehow. In the greeting hall, the player finds two spirit tablets. When the player looks at the tablets, all the sudden an image of a wedding setup in the hall is

revealed but vaguely it looks like a funeral at the same time. Back to the tablets, the player notices that the last names of the bride and groom are both 'Yang', which means the bride was very likely bought to the house of Yang according to the tradition there.

To the master room, the player finds a letter describing an accident involving Yang Jr. and a wedding notice from a couple of days after the accident. With questions, the player goes to guest room, and evidence shows that a doctor has been here with a death certificate of Yang Jr. after the accident and before the wedding. What???

With even more questions, the player finds himself in the side room where a notice is discovered. The notice reveals that the tradition here is to buy a near-age dead girl as a ghost bride for a young boy who dies single. A shocking letter is found later that they couldn't find a recent dead girl, and instead, they bought a near-age girl to burry live as the ghost bride after the wedding.

Ending one:

Entering the garden, the player spends some time looking for more details with weird things going on. After a while, he finds it has become a graveyard where the whole house was buried a long time ago. A new tomb catches his eyes and shocks him as his name is on it. He turns around: the palace is the graveyard and the girl who has been guided him is the bride laying in the bride's tomb.

Ending two:

In the garden, the player finds a diary of the bride saying that she had been sold to the house due the poverty of her family, and now that she was named Yang but she claimed she won't forget her original blood: House of Lin. According to the clue, the backyard door is

opened leading to a tower where his aunt's spirit gets released for finally meeting her own blood relative.

2.3. Horror Development

As introduced in section 2.1 via a horror experiment, we want to take the advantage to deliver experiences of fear, but differently the horror this time occurs in ancient Chinese environment instead of a abandoned veteran hospital — a stereotype of Western horror. Eastern Asian horror is primarily psychological horror conditioned deeply on retributions, that is, whatever a person does in the past would eventually haunt him/her at some point. Knowing something incoming and yet not aware of what is upcoming is the base of the fear we want in the game. When the retribution actually comes, the fear is strong enough making you feel incapable of doing anything against it. The feeling of fear originates from potential misgivings about the restriction on one's survival and self-development — one of man's self-protection awareness.

2.3.1. Isolation in horror games

When we live in life, we seek community, guidance, and help from others. We come into this world connected to other people, and grow up depending on them. It takes years for us to truly function without another individual, but we still need people and find comfort in the presence of others. When we are isolated, it is natural to feel scared. Horror games capitalize on this by putting players in situations where they are alone. Having to explore a quiet town or a mental hospital by yourself is a typical horror scenario. Just being alone in an environment, hearing only the wind or the rustling of leaves or other more ominous sounds is creepy. Games use this tactic even better when they show you that it is possible for you to be with others, but a

certain situation prevents this. *The Palace of Monarch* creates an isolated place which fulfills the needs to feel isolation within.

2.3.2. Tension in horror games

Tension in video games is derived from mental or emotional strain. Horror games must have tension to be successful; we cannot let our player feel too comfortable or confident as he or she plays through the game. Tension is achieved in a variety of ways. The first comes from the disempowerment aspect: resource management [33]. Nothing is more stressful than having no weapon and untold numbers of threat in a horror environment. Having to scout an area for items that can defend yourself or escape the situation adds to the tension of a game. It also puts players in positions of agency whether he or she should explore more.

2.3.3. Uncertainty in horror games

If knowledge is power, then a lack of knowledge is weakness. This is why we are afraid of the dark. It is not darkness itself that we are afraid of, but fear of what could be in the dark. In essence, a person's mind becomes his or her greatest enemy. A common theme in successful horror games is just that: keeping players in the dark by forcing them to imagine what the horror is. No matter how scary a monster is, your mind can make it scarier; that is why good horror games do not immediately throw the enemy right at you or explain to you what it is. Uncertainty plagues your mind with fear-seeing a quick passing image in your periphery, a tentacle pulling back into water, a snarl in the distance [33]. These fleeting images build up a horror game, adding to uncertainty. Showing the monster, then explaining it with loaded exposition, is a huge shortcoming because it empowers you with knowledge. Not knowing heightens your sense of vulnerability and adds to fear.

2.3.4. Lingering fear in horror games

The best horror fiction puts something into the mind of the one experiencing it, something that stays with the player after he or she has put down the controller or closed the book. Most people who saw the movie “Jaws” for the first time experienced a lingering fear of sharks, their mind straying to bloody attacks as they tried to enjoy the tranquility of the ocean [28]. It is a fear that remains with you long after you have watched the movie. Great horror games do not stop scaring you after you are done playing; the fear lingers until you can finally purge it.

2.3.5. Claustrophobia in horror games

In *Gaming Horror’s Horror: Representation, Regulation, and Affect in Survival Horror Videogames*, Tanya Krzywinska states that *Silent Hill* (1999) provides a classic example as it deliberately interferes with player performance by taking away the power to see what is coming and removing a player’s ability to read real space sound cues. The game removes the cues that players expect to use in order to manage and contain situations. Unnerved and blinded, unable to act as efficiently as would be expected, this tallies with the use of tropes of claustrophobia found across Horror and Gothic fiction to stimulate affect to produce sensation and emotion. Panic is of course a highly effective way to disrupt a player’s sense of self-assurance [23].

With some shared similarity in *The Palace of Monarch*, claustrophobia is a key feeling we want to deliver. The authentic architecture builds up the environmental sense of narrowness so that the player would experience being awed and trapped at the same time. Due to the design of ancient building, the layout of a palace looks cubic and looped with close wall-to-wall sub-yards that usually contain a house each where the puzzles rely. Taking away the physical ability to fight against the mystery, the player can only solve puzzles to find out the truth behind the

palace. Regardless the freedom to explore the palace, the darkness will fall to increase the difficulty by making things less visible and more horror environmental cues as the game progresses. Thus, claustrophobia results in serving horror temporally and spatially.

2.3.6. Being haunted in horror games

Carrying on with claustrophobia from last section as one of the major experiences, more environmental objects and incidental events would also occur near the protagonist during the gameplay to form a haunted palace.

Player control is mostly managed through more conventional effects such as lighting. It can echo the use of lighting in horror films and games, where very likely dangers are hidden in a dim environment from protagonists. If we put it in another way, the invisibility of threats is applied to our protagonists, yet the sense of dangers is privileged with the omniscient knowledge, thanks to pioneers in horror production, that people have all experienced more or less [24]. Since it becomes difficult for players to visualize the threats, the feeling of being haunted or threatened falls onto the player with curtailed perceptions. That being said, the lighting has very different ways to be implemented under specific circumstances. Most commonly, the ambient light will get darker as a mimic of nightfall; some have variation of brightness accordingly to collaborate with puzzle solving.

The protagonist, as a lone individual being trapped in an old palace, must confront something ghostly but untouchable in order to ‘survive’, or at least try to escape the terrifying situation. On the gameplay level, the player needs to search for clues, gather objects, and eventually solve puzzles to again ‘survive’. As it has been practically used in many media, sound here will play an important role to make some threats sensible or be the threat itself, as mentioned previously in addition to limiting players’ vision.

Horror computer games are not only designed to generate fear based on their narrative setting or the iconography they employ, but they are also conceptualized to produce what Bernard Perron called

gameplay emotions [25]. According to him, these games engender three different kinds of emotions: (1) fictional emotions which “are rooted in the fictional world and the concerns addressed by that world”, (2) artefact emotion emanating “from concerns related to the artefact, as well as stimulus characteristics based on these concerns”, but mostly (3) gameplay emotions “that arise from the gamer’s action in the game-world and the consequent reactions of this world” [25]. With classic Chinese Guzhen light music as the ambient background music, it catalyzes immersion in the environment of ancient Chinese palace, retrospectively and deeply along with archaic sound effects for specific objects such as old door, pot, scrolled painting, and so on so forth. While all horror computer games are provided with a more or less elaborate fictional setting, in the end, it remains a part of the experience of gameplay: exactly the point in our case [26].

3. Level Design

Originally we thought about linear gameplay, which nudges players along in the right direction with no allowance of real exploration. In this way, we can concentrate on immersing the player in the story we crafted. Nonlinear design would put players in the game world where they can do whatever they please with no real guidance other than a story they can progress when they want to. However, what we wanted to create a combination of those two methods. From the moment players start playing and put down the controller, the mission was clear. During the gameplay, players are given choices on how they want to go through the level to accomplish the mission. Freedom of choice for the player is an interesting take on the idea of non-linearity but throws it into a game that is largely linear. With the story in mind, we briefly describe a walkthrough of the first three levels in following sections which we hope to provide a sense of what we are trying to accomplish.

3.1. Walkthrough

Our initiative is to release *The Palace of Monarch* after production. The way of sales is going to be episodic. Thus, we currently design 3 levels as the first episode for our game to see the reaction of the market. In addition, the first 3 level leads players to the first room in the palace with limited clues to unveil the story but keep up the curiosity about what has happened in the palace among players with motivations for future episodes.

3.1.1. Intro Scene

Chapter Name: The Letter

Following the narrow path of rotted steps, Lin tries to climb up to the top of the mountain, a place Lin has been destined to visit. The faint sunlight of the dusk retains some

precious warmth to spare no effort to energize tall bamboos and high bushes along the way which sometimes block the view and yet gloomily lead the way towards mystery. Lin has to retract his attention to the sceneries, because the nightfall is happening. Before it gets dimmer, he pulls out the letter from his father to remind himself that he, as the successor of Lin's Palace (林府), must investigate Yang's Palace (杨府), as known as *The Palace of Monarch*.

Inattentively, Lin has reached the top of the mountain, so he retracts the letter and take a glance. On a flat terrace surrounded by a forest of bamboo and high bushes, a big old torii stands in front of a fence-locked bridge gate like a doorman, robust but old. Underneath the torii, a post house splits into two on left and right hand side of the bridge gate. Along with a field lamp being lit up, a tender voice brings him back from the environment saying "Hurry up! Come to me!" Oh, his guide, a little girl he almost forgot he coming up here with, is the one shouting.

3.1.2. Tutorial Level

Chapter Name: Before Nightfall (see Fig. 3.1)



Figure 3.1: Tutorial Level Scene

The little girl explains that she has been a guide and messenger around this palace for years. She knows exactly how to get to the palace. As she's talking, she hands an old letter to Lin on which it shows four elements in Chinese: Wood (木), Water (水), Soil (土), Fire (火). Being noted, these elements will help Lin get through some troubles when unlocking a coded box. With the girl's guidance, Lin approaches the potboard on the right of the torii next to a cliff. Skimming through all the pots on the board, he easily finds a locked box inside one of the pots, on which it shows exactly two-digit passcode with any combination of the four elements on the letter. With no clue how to solve the combination, Lin decides to ask the little girl again for more. After turning around, he is surprised by that the little girl is already behind him as well as a bit shocked

that he didn't hear her walking to him. Well, it might be just that he was too concentrating too much on searching for the locked box. She giggles and leads him to the pot board on the other side of torii, where the clue for the combination relies.

Passing by the torri, Lin finds a stone lion on a pillar very attractive with its magnitude and its craftwork. He listens back to the little girl and notices the paintings behind two pots which indicate wood and water. Recalling from the letter, the combination for passcode reveals and unlocks the box: a symbol metal. Holding that, Lin turns and the little girl smiles at him explaining that the symbolic metal is a key to open the fence of the bridge and the keyhole should be somewhere on a pillar under a stone lion. That reminds him immediately that he has passed by the stone lion with some awe inside before. However, the darkness has fallen and nightfall is here. With only a road lamp at the beginning of the path, things are vague and dim nearby. Lin sees a stationary lantern next to the pot board which should bring up some light. He lights up the lantern as he thinks. Although it is not bright enough, it reveals the symbol under the stone lion, which is so pure and golden. Thus, Lin matches the symbol and pushes it in with a sound of fence collapse coming right after. All a sudden, the road lamp gets dimmer and another on the other side of bridge gets brighter which seemingly is alive trying to attract him going that way. The little girl stops Lin's thinking process by giving him a final letter, wishing him good luck, and saying that she wishes she could see him again. Wishes she could? Then Lin decides to move forward, and again she disappears without a sound into the darkness. Although this all seems weird, Lin takes his step towards *The Palace of Monarch* without any hesitation.

3.1.3. Second Level

Chapter Name: Upon The Entrance (see Fig. 3.2)



Figure 3.2: Second Level Scene

The night has fallen like a black lid on top of a box, sealed and suffocating. While Lin is walking on the bridge towards the gate of the palace, the only sound can be heard is his footsteps and breaths: the true silence — no sign of the living although you might see trees. As that thought passes through Lin's mind, he steps onto the ground of the side of where the palace is. All the sudden, the trees start joggling like a pendulum, alarming and announcing Lin's arrival. Like a welcoming party, the lanterns are lit up: the one for the road and the ones on a carriage next to the gate with red lights, festival and yet eerie.

Lin walks up the stairs to the gate, which is locked, and he glances around. A little reflection off the red light on carriage catches Lin's eyes; a silk bag lying there. Lin grabs it and

opens it up: a symbolic metal or as far as we know a key. With excitement, Lin is back to the door looking for a keyhole since the key was just being found. However, it is too dark to get a closer look at the details on the door. Wondering, he walks to the lantern on the sides of the door trying to light up the lantern like he did before. It works like the way it was at the terrace with the little girl where, while lantern is on, the keyhole was lit up, pure and golden. But this time, there are two of them. He pushes the key that matches in. With a cracking sound, two small side doors on the main door open. They are small but big enough to take a glimpse of the inside palace.

While looking for the second key, Lin finds a box sitting next to a rock near the cliff. He picks it up that shows similar technics of a lock whereas the combination of Chinese characters are different this time. That reminds him a letter the little girl left him earlier. In the letter, it is exactly the Chinese characters shown on the box. As the letter inferred, there are supposed to be two guardians revealing the clue of the combination. But where are the guardians?

As Lin is struggling on finding the two guardians, he hears some lady moaning inside the palace, which shocks him, for the palace is supposed to be abandoned for while. However, it's gone after a bit that leaves Lin questioning himself whether he actually heard it or it was just acoustic. He looks around and finds nothing related to the duo guardians mentioned in the letter, for which he infers there must be something about the side doors opened earlier. With that in mind, Lin walks back to the main door where the side doors are open for glimpses into the courtyard of the palace. Vaguely, he sees there are two big stone lions sitting in front of the greeting hall with no specific color on them though. While he is backing up a little bit to get a good angle on both, the stone lions turn into blue on the left and green on the right! 'Aha!' He happily shouted. With the combination found based off the letter interpretation, he is able to unlock the box to acquire the key to the main door.

Carefully, he matches the key to its key hole and then the main door opens slowly with crunchy sounds that give him goose pimples. Uncertain about whether it is illusion or not, he feels night just falls as the door is opened, as if one is whispering “Welcome to the palace~”

3.1.4. Third Level

Chapter Name: Mr. and Mrs. Yang (see Fig. 3.3)



Figure 3.3: Third Level Scene

Entering the palace, Lin can barely see the details of the palace interior due to the darkness. At the moment, he finally realizes that the night is here. The little girl’s saying about not going in during the night suddenly comes to Lin’s mind; however, it is too late as he turns around finding the door is already closed somehow without the crunchy sounds when opening. While he’s questioning what has happened, a road lamp is lit up gradually like it was waiting for

him. Coming into his eyes, it is the two stone lions he saw through side doors earlier, like guardians of a magnificent greeting hall. In between, a red tree is flickering in front the hall like it was waving to Lin.

Following the only light source, Lin enters the greeting hall with typical Chinese interior where a couple of wooden chairs and desks on top of which there are some handcrafted vases and tea pots. He takes a deep breath and walks in lighting up one of the candles on the main desk at the center of the hall. With some lights, he checks the surrounding and finds that there are two screens on two sides: left one to upstairs and right one to the back room he assumes.

Lin realizes the handcrafted vase on the left is a bit loose so that he tries to pick it up. Instead, the vase is turned and the screen on the right is scrolled along with the vase. Behind the scrolled screen, there is a painting on the wall and two candles under it. With curiosity, he lights up the candle trying to get closer look of the painting. Once the candle is lit up, the painting turns blue and green separated in top and down. While looking at the painting, Lin is distracted by a flashing light which leads to an ancient compass, on which there are four clock hands and the color characters underneath. Inspired by previous puzzles, he turns two clock hands to blue and green. A mechanic sound occurs right after behind him. On the other side of the room, a sun-shaped item and a moon-shaped object start moving towards each other. After some time, they connect and start shining red color on the sun and yellow color on the moon. With that information, he turns the rest two clock hands to the colors. Then, the screen on the left starts scrolling and a light is somehow lit up upstairs illuminating the stairs: flickering yellow and creepy. Lin hesitates for a bit and steps up.

3.2. Characters

Lin (The Player):

Lin is 26 years old, and he lives in Shuntianfu, the Chinese capital during Ming Dynasty. Lin move here since six years ago and he works in the official here.

We have not designed the main character yet, as there is no appearance of Lin in game scenes. Potentially, we are going to implement his hands as controllers in game since our game is first person perspective.

Jiang:

Jiang is 28 years old. He is Lin's best friend. He lives in Yingtianfu, which is in the south part of the country, and he wants to move to the capital for business. The only appearance for Jiang is the name on the letter where he asks Lin to visit the palace.

Yu (The Little Girl):

Yu is 12 years old. She lives near the palace and usually comes to play in the palace. She appears in the tutorial scene of our game to guide players through introductive gameplays.



Figure 3.5: Character Yu: concept image (left) and game model (right)

The character, Yu, is designed to be a normal girl during late Ming dynasty. Being normal during the time is that people would not be able to afford luxury clothes — the luxury clothes are usually colorful and bright with shining colors like gold and silver which were the currency at the time. Instead, we want to have a little girl looking naive and modest like a common little girl who would have looked like during the times. Thus, we have taken the reference, shown on the left of Figure 3.5, to conceptualize our model design on the of the figure. The conceptual art on the left shows purple color on top which we decide not to use for the reason that it might look over-blended into a dim environment. As it is shown in the game model

on the right, there is some jewelries on the girl, although we stated our vision of her design. The reason to do so is that the little girl has potential factors of taking parts of storyline where her bracelet and jade on her waist could mean some relationship with Mrs. Yang, the ‘ghost’, who we talk about next.

Mr. & Mrs. Yang (Name on the Spirit Tablet):

They are 40 years old, and they own the palace. Something happened to both of them, and they died due to the tragedy. Mr. Yang’s father moved to the South and asked a housing firm to sell the palace.

Mr. Yang would never appear in the game but his name; yet, Mrs. Yang takes a big role here as she is the major character with or without an entity in the game. Since we have not decided whether or not she should show in the game, we have not designed her model in yet.

4. Environment design

In this section, we discuss about the progress of how we develop the architecture, the map, and the environment for *The Palace of Monarch*. As our game is a horror puzzle game that happens in ancient Chinese palace, we want to create a feeling of being lost and trapped for players, and the palace is designed to be surrounded by mysteries.

4.1. Architecture Inspiration

We designed the game map according to the ancient Chinese architectural style. The first major theme is the layout. Chinese aesthetics were very consistent, existing within a unified system of art, and so Chinese structures were defined by the same rules as painting, sculpture, and music. Two of the most fundamental elements of this aesthetic are symmetry and balance. Symmetry and balance are obtained by dividing the complex along a central axis. Buildings on opposite ends of the central axis often mirrored each other, with courtyards separating them.

In order to carry out the Eastern Asian horror experience for players, the virtual world they will be in needs to apply the aesthetics of ancient China as a foundation of the setup. We worked with ancient Chinese architecture, looking for reference for that we want the result looking as close as possible the actual Chinese palace in the past. Basically, we expect players will leave the game with some ideas of ancient Chinese architecture to some extent where they will be reminded when they actually see one in real life as well as the feeling being within the building/palace.

Originally, we started off with the idea to leverage the implementation of Suzhou Garden from Southern part of China, which is referenced in Figure 4.1. The reason we chose this type of

architecture as our reference was that we are more willing to be somewhat propagators of Chinese cultures in such a way to build up the interest for people from Western countries. Plus, Suzhou Garden is listed as World Cultural Heritage, rated ‘AAAAA’ in national scenery ranking, and ranked in top 10 list of the places of historic interest and scenic beauty in China. For the titles it has, the garden is a perfect reference for us to create the virtual environment upon [30].

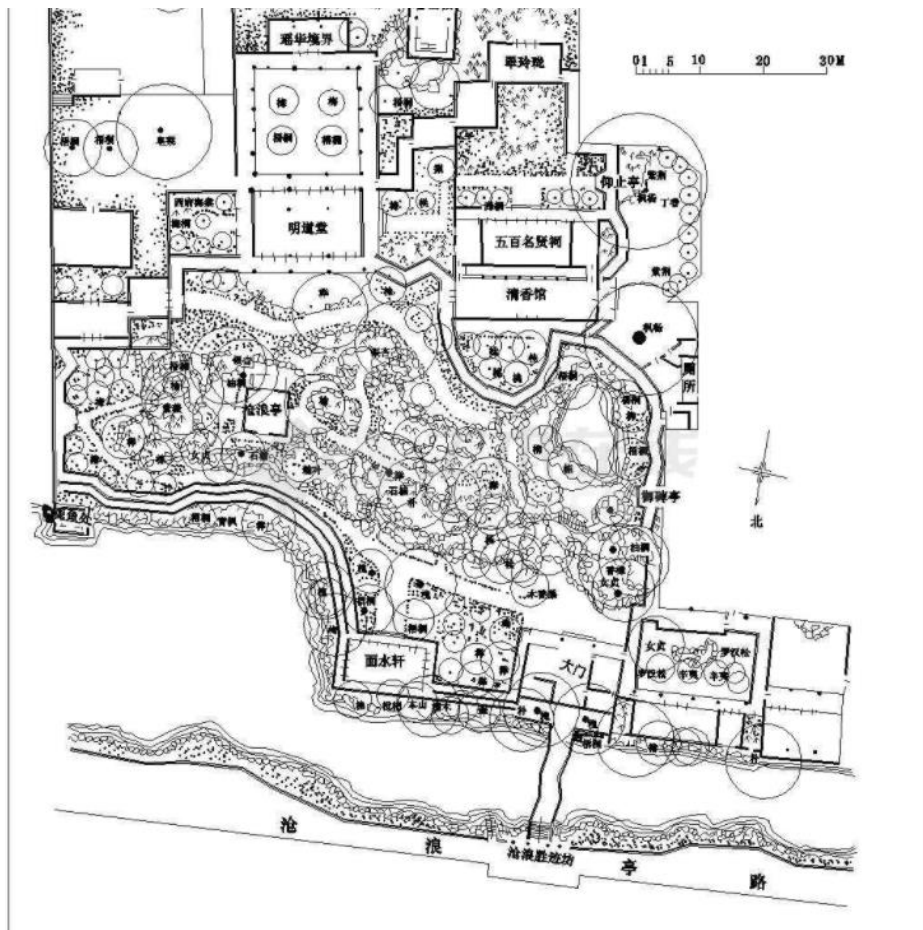

Figure 4.1: An imaginary garden plan of Garden of Harmony [30]

To serve our needs in development for the game, we use the design of Suzhou Garden as reference to aim at the feeling of being trapped within a maze [31]. As shown in Fig. 4.2, the layout is complicated enough to get lost within even for people who have been there multiple

times. The authentic design was to have audience looped in the scenic tour as poets in the past described in the poetry that, with familiar voices shouting out to look for me, I cannot tell or see where the voice comes from. That in a way indicates that the garden is a maze that people can easily get lost and may not find each other even though they are nearby.



Figure 4.2: Inner View of Garden of Harmony [30]

In addition, the pathway is always narrow for two people at the most walking side by side. People back in days would just focus on the main visitor, who usually was a governor or dignitary with an interpreter who usually the owner or relative to the owner explaining/discussing over the scenery. Regardless the original purpose, the design of narrow pathways fulfilled our design to deliver the feeling of claustrophobia.

4.2. Map Design

Along with the design process, we realized that the whole Suzhou Garden design was a bit too big for our scope and a little off of the topic, which is the palace. Usually, it is the backyard for a palace and the palace is the primary architecture at the beginning. Thus, we decided to look into some palace design for the game to start off with.

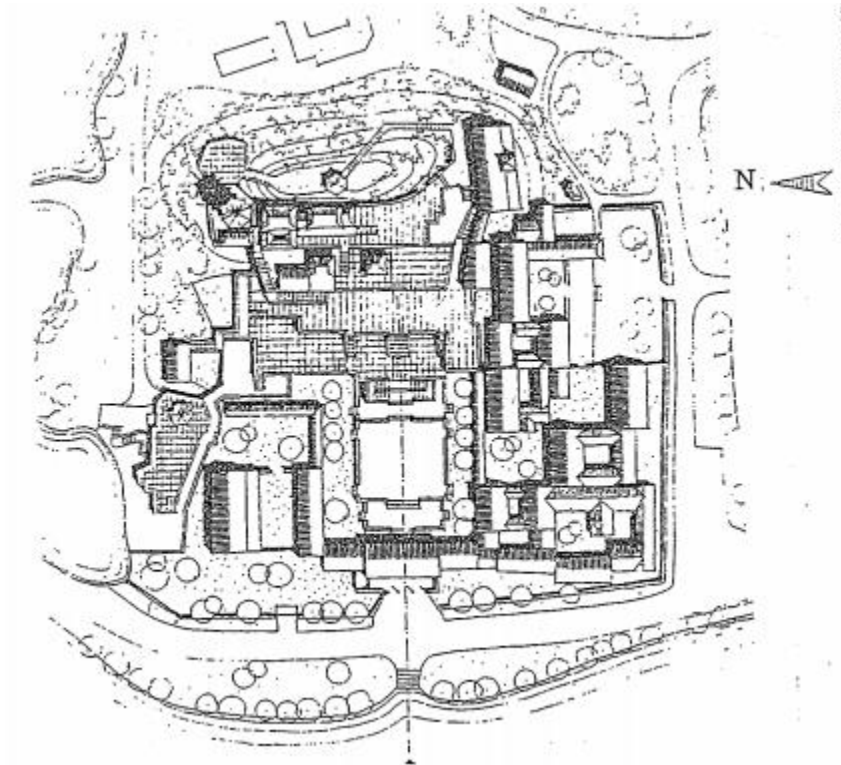

Figure 4.3: Golden Hill Temple, Zhengjiang, Jiangsu [32]

Images, shown in Figure 4.3, refer the advanced design of our game, whereas it shows only the palace layout regardless the backyard. In order to drive revealing of the story, a palace would make sense to have information restored in, such as letters, paintings, and so on so forth. With the design of the backyard referencing Suzhou Garden still in mind, we have it placed in as

for later expansion or chapters/DLC, here is our palace layout based on the resources (see Fig. 4.4):

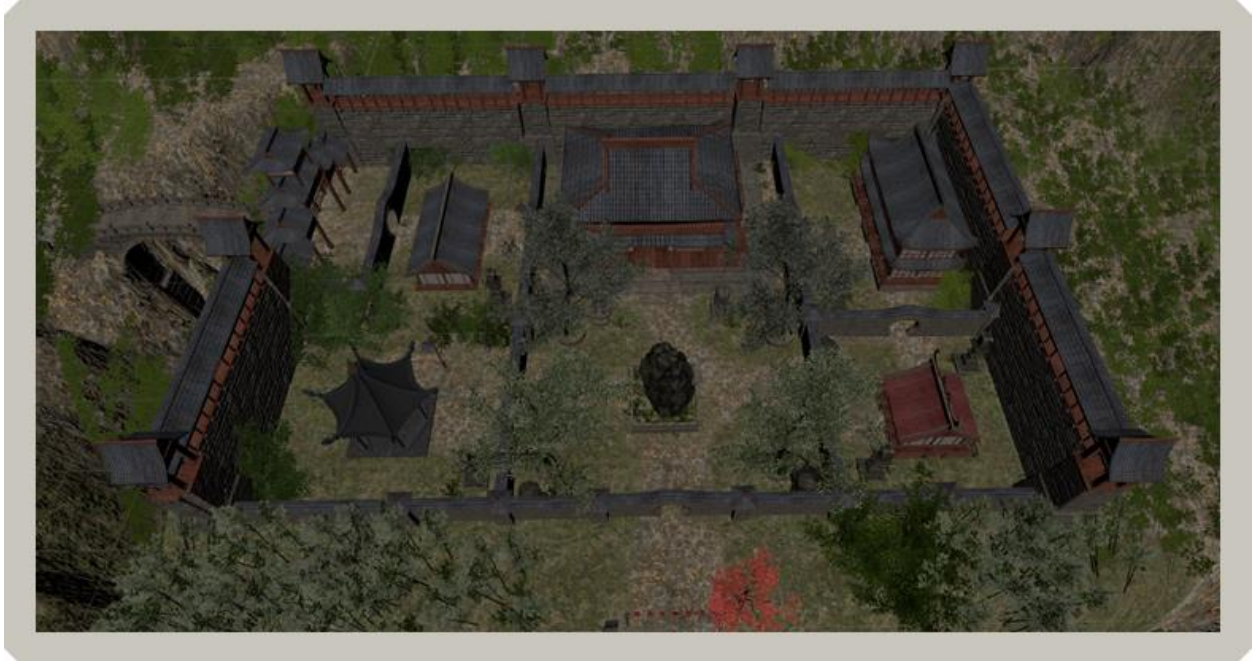

Figure 4.4: Game Map Layout

The design is iconic Chinese palace with greeting hall, master room, guest room, and a garden room which will be discussed in detail in later sections. On the left side of the map, the player will notice a bridge connecting to somewhere outside of the palace that will lead to the Suzhou-Garden-based backyard to start off with an expansion.

4.3. Light

Lighting in a game is essential a virtual environment. In most cases, it can build up the mood corresponding to the surroundings; it's able to highlight things like objects, scene, or even direction in a game; it is capable of participating in game mechanic as a part of puzzles in our

case. Although the player has active control over the game world, the lighting as an agency mechanic proactively curtails the player's control.



Figure 4.5: Sunset Light Scene (left) and Moonlight Scene (right)

In *The Palace of Monarch*, we have two kinds of ambient lights: sunset light (see Fig. 4.5) and moonlight (see Fig. 4.5). Both of them help add some flavor of mystery in addition to the Chinese ancient architecture which we discuss about in Chapter 4.1. In the game, an ambient light generally indicates the gameplay progression as it gets dimmer corresponding to the elapse of game time; the game starts off with sunset light which will transit to moonlight at certain point to inform players that the night has fallen down to the palace area. During the gameplay, moonlight will be a light source that allows the player to see his/her surroundings faintly. According to *Horror Returns to Chinese Cinema: An Aesthetic of Restraint and the Space of Horror*, in the darkness with fear, the player may find it as a harbor or guidance in his/her heart [4]. However, we hope to design the transition from sunset to night not too obvious for that players do not feel distracted by a sudden shift of lighting. Thus, the transition takes place slowly as the game progresses.

As ambient lights set up the overall atmosphere, a road lamp works as a guidance to lead the player through the palace, like a lighthouse over the sea at night. Each building or

construction has its own road lamp at the entrance, which will be lit up once this room is unlocked for further exploration. The design is inspired by one of human instincts to follow the light in darkness. Although the game is not going to leave the player in a complete darkness, the player would feel the surrounding dim enough to follow a light source, pursuing better vision to get a feeling of security.

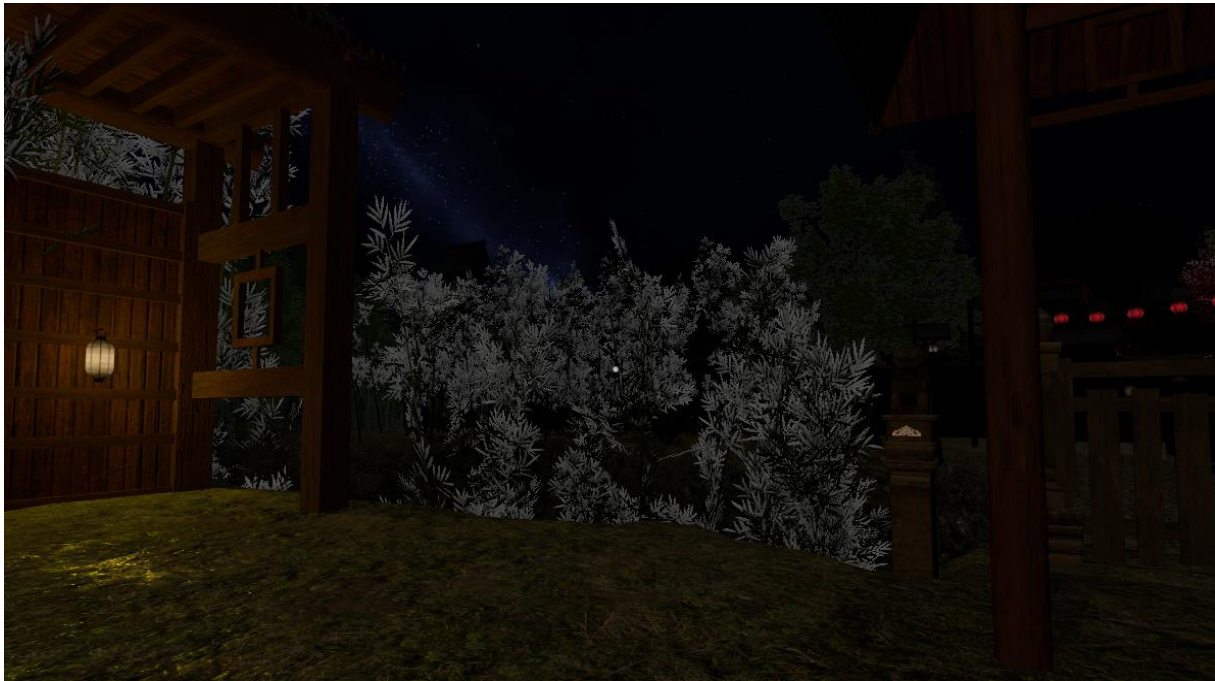

Figure 4.6: In-game Scene of Lantern to Keyhole

Moreover, a light is also designed as an environmental object in the game which works as a puzzle piece or a piece of puzzle hint in some cases. For example in Fig. #, on the left hand side there is a lantern which is already lit up. The lantern here is considered as an environmental object with the functionality of a light source. Now that it is lit up, a symbol on the right hand side of the figure which is a part of a puzzle is also highlighted for a better view for players to find out. Being fairly important to puzzles, the lighting is not all but partially serving our puzzle

design which includes various traditional Chinese items and cultural elements like language, some of which infer deeper meaning underlying the gameplay.

5. Puzzle design

In this section, we talk about the puzzle design in *The Palace of Monarch* along with some traditional Chinese gadgets. We might have seen some of them before as Asian culture is somewhat international nowadays. We briefly cover the items that players will come across during gameplay and introduce the relation between items and puzzles. As the objects in game unveil a story, some have obscure meaning for players to think over after.

5.1. Symbolic Representation: Maple/Red Tree



Figure 5.1: Red Tree at Greeting Hall

The buildings have one maple tree each near the entrance, along with a road lamp, making the entering feel iconic at some extent (see Fig. 5.1). In addition to that, the red color of

the tree is symbolic and outstanding with other trees being dark green and somewhat white in the game. However, those maple trees are not identical, having a meaning of progression by withering when the puzzles are solved and the palace is traversed – the player will probably notice the change of the maple trees with withered leaves falling down and gradual transition into a bald leafless tree. The player will likely traverse the palace and would be influenced by some abnormal events and activities unconsciously. Deeply, it also implies the life of the main character is worn down by the mysterious and ghostly palace.

5.2. In-Game Objects

Since the game happens in an ancient Chinese palace, hidden objects are all from ancient China. Texts on hidden objects will be written in Chinese with English translation provided in subtitle and background vocal narratives for important texts. Further, other significant objects themselves stand for meanings that will help the player better understand and solve puzzles. For an instance, some paintings with a Chinese word in drawing may not be a direct solution to a puzzle, but it might have has meaningful content that can help the player understand what a word/item means. Possible objects include:

- Chinese Letters
- Books
- Portrait
- Chinese Paper Fan
- Locked Box & Key
- Chinese Compass
- Water wheel
- Chinese Writing Brush
- Paintings

- Mirror
- Spirit Tablet (Chinese pray for the dead)

The objects listed are designed as puzzle pieces, in which informative objects like letters and paintings reveal some clues to puzzles or unveil the story; manipulative objects like compasses and water wheels are interactive with players as a form of mechanics to a puzzle. In most cases, the information on informative objects is interpreted by objects themselves or their geometries which leave players to find out.

5.3. Symbol Interpretation & Recognition

Symbol interpretation and recognition is fairly important for solving puzzles because it is the basis of word interpretation puzzles. Thus, it is something the player should be able to start with.

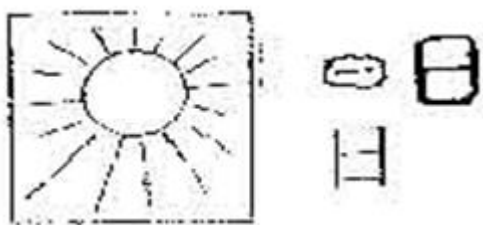

Figure 5.2: Chinese Character with Drawing [7]

In Fig. 5.2, the Chinese character “日” (“ri” pronounced in Chinese) on right hand side represents the picture shown on left-hand side, which is a sun. There, the player is able to begin with some basic Chinese characters for upcoming puzzles, building understanding through examples from written texts on found objects.

Once the player learns basic Chinese characters through symbols, he/she is supposed to find out hidden meaning through the text on found objects [7]. For example, after teaching the player two Chinese characters “日” (sun in English) and “月” (moon in English) by symbols shown in the image, a letter will have some statement indicating that the combination of these two characters means something else, which will solve the current puzzle and lead to the next puzzle or even the goal.

5.4. Connections of Objects to Puzzles

As mentioned in Symbol Interpretation & Recognition, we design our puzzles based on Chinese characters and in-game objects serve the purpose to create difficulty and generate connections between interpretation of the language and geometry of objects in the game. For example, a puzzle in the greeting hall in the game would show orienting words in Chinese characters. To conduct this, we have paintings with characters on North, South, East, and West sides and the Chinese compass explains its meaning (see Fig. 5.3).



Figure 5.3: Chinese Compass

The connections of objects to puzzles are sometimes abstract but logical. As our puzzle design starts off with a goal to interpret Chinese characters and conducts through objects, we can duplicate puzzles easily as long as we have reasonable logic of the connections. To make it easier for expanding puzzles in future levels, we create a grammaticized architecture of puzzle design technically in order to optimize our further development.

6. Technical Development

In this chapter, we discuss about the progress of how we create a relation between actual puzzles and programs following the flow: inspirations from other sources, definitions of puzzle into pieces, and conduction between visual puzzles seen in the game and programs run underlying a system.

6.1. Architecture

In this section, we talk about how we get our inspiration to start with. Then we show our brainstorm process to formulate the basis of the architecture of our puzzle system.

6.1.1. Inspiration

Joris Dormans through the article, *A Handcrafted Feel: ‘Unexplored’ Explores Cyclic Dungeon Generation* [15], emphasizes the importance of the idea of Cyclic Dungeon Generation which was originally brought up during a research workshop at the Banff Center in Canada. The fundamental of the idea is, recalled from section Inspiration, to form a cyclic loop with two paths between nodes. Then, we consider the cycles as a unit – an atomic pattern that helps exploit the topology of level design, like one key-to-lock puzzle. Being said, the map would eventually build up the main layout or cycle with all those atomic patterns. The players would fall into a predesigned loop. To highlight, this design intends to generate retrospective and intangible structures deliberately.

In a great number of cases of generating dungeons or levels, designers tend to keep adding pre-designed fragments of assets to levels ending up with a tree-like blueprint. In this case, the tree (level) will eventually create many dead ends due to its tree-like layout with ending points in

branches. Sadly, players would have to backtrack or wander around at some dead end all the time.

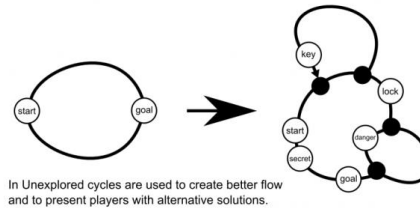
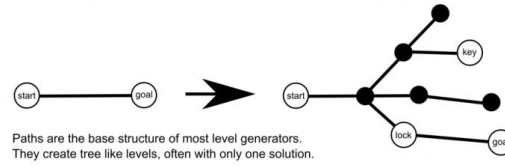

Figure 6.1: Unexplored Map

Figure 6.2: Tree vs Cycles

This fundamental approach has been changed in a few games, for example dungeon crawler Unexplored (see Fig. 6.1; [15]). Joris Dormans pointed out the level design in Unexplored (see Fig. 6.2; [15]) starts off at an arbitrary point somewhere on the map. Instead of just linear paths, it generates its basic structure of level in cycles to keep players in loops in a good way. Random cycles would make the game verbose and cause the player to feel impatient. Nonetheless, Unexplored has its way of level design to create a better flow with loops offering players alternative solutions instead of repeated nonsense cycles.

6.1.2. Cyclic Dungeon Generation

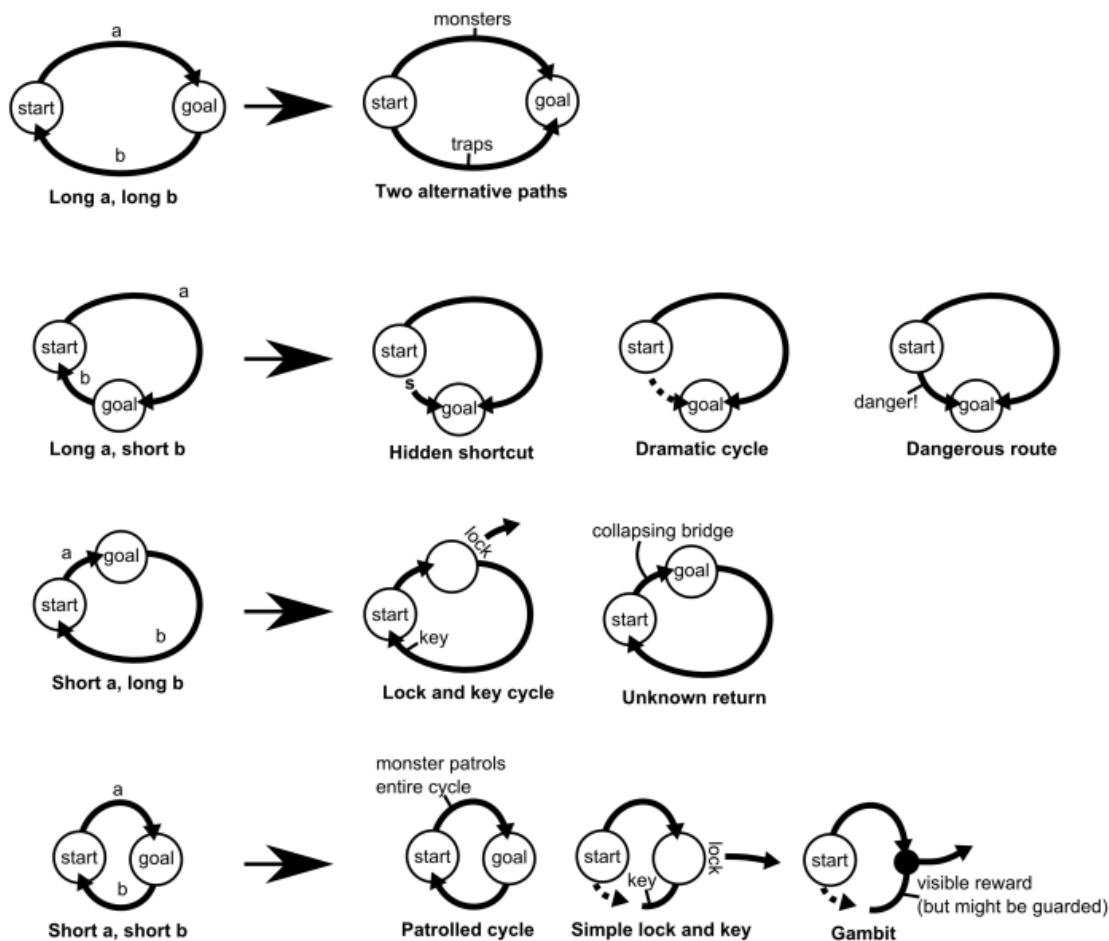

Figure 6.3: a couple of cyclic design patterns

In the same article, Joris also introduces some basic design of the pattern. Shown in Fig. 6.3, each cycle has a path ‘a’ that leads from the entry point towards the goal, and a path ‘b’ that leads back. Depending on the absolute and relative lengths of ‘a’ and ‘b’, we can change each cycle into a design pattern. For example, when ‘a’ is short and ‘b’ is long, you can place a locked door at the cycles goal, and place the key at the end of ‘b’ just before you can cut back to the main path. This creates a level where players first encounter the locked door, and when they do find the right key, they do not have to go far to reach the door it unlocks. Obviously, this makes

it so that the player cannot reach ‘b’ from the cycle’s entrance straight away, although it might be interesting if they can already see ‘b’ and the key. Another example that works well with a long ‘a’ and a short ‘b’ is to put a secret door between the entrance and ‘b’, creating a hidden shortcut. Or maybe ‘b’ is simply a more dangerous route than ‘a’, taking the player past a dangerous foe or requiring the player to navigate a trap infested room. There are many possibilities, and Fig. 6.3 lists a couple more. One of our main design goals is to keep players in the loop that they would feel trapped and Deja Vu so that they cannot tell if they have even been a place in the palace. In addition to that, it also helps mislead players to think that the palace is huge, but it is actually cyclic.

6.2. Grammar Definition





In section 6.1, we have a vision of what a puzzle system should generate. To meet the goal, we start to research from others and define the grammar of our puzzle system.

6.2.1. Graph Grammar Design

Graph grammars are discussed in relation with level generation by David Adams in his 2002 Bachelor's thesis *Automatic Generation of Dungeons for Computer Games* [17]. Graph grammars are a specialized form of generative grammars that does not produce strings but graphs consisting of edges and nodes. In a graph grammar, one or several nodes and interconnecting edges can be replaced by a new structure of nodes and edges [16]. Although it was originally designed for automatic generation, the benefit of having it in general level design is remarkable as well. Formal or generative grammars originate in linguistics where they are used as a model to describe sets of linguistic phrases encountered in natural language [18]. Formal grammars typically operate on strings, but this need not be the case. Graph are more useful than strings to

represent mission structures and can also represent space. As the grammar to any language, the graph grammar is the way to simplify and standardize abstract logic and relations of every element in a game.

The roots of the graph grammar are shown below:

1.  = entrance/start point
2.  = lock (we use this to represent result/end of a puzzle; not necessarily a lock)
3.  = key (a hint/solution to a puzzle; not necessarily a key)
4.  = task/process
5.  = goal

The graph grammar can generate various ‘sentences’ (a puzzle in our case) with different combinations of the roots listed.

6.2.2. Atomic Pattern Design

Since the roots have been introduced, a unit (atomic pattern) can be implemented to codify level design principles. In this section, we explain our design by using typical lock-and-key structures, which represent most of our puzzles – hint(s) to solution(s) or disguised as different items. For example, the lantern in our game can be both a light source and a key that can be used in various ways. It has capability to reveal some material or activate switches that are sensitive to

light. To solve puzzles, the player needs to manipulate ‘keys’ to unlock ‘locks’ to move forward with the puzzle.

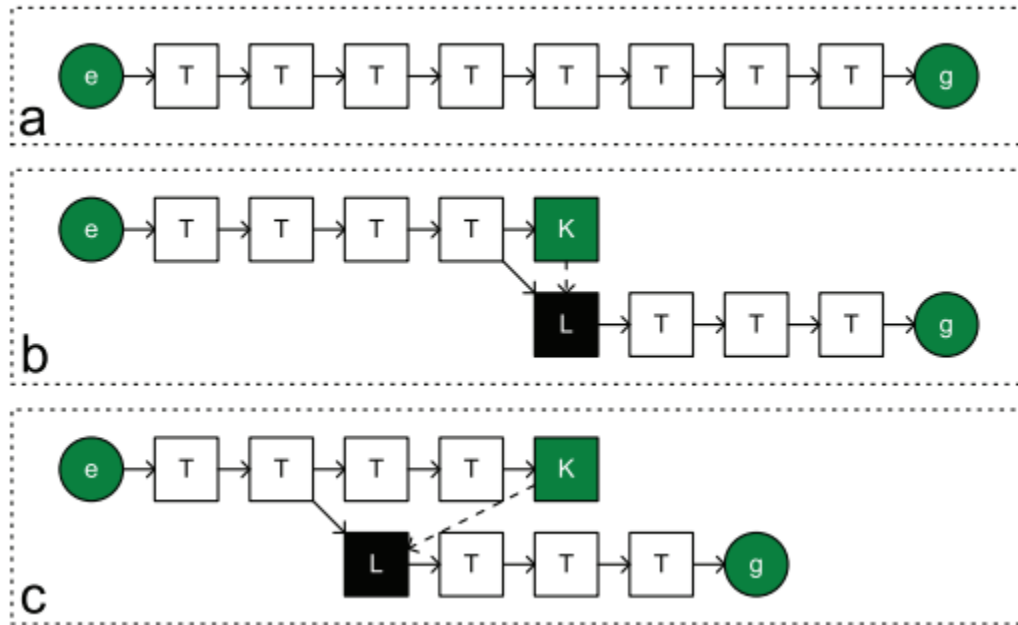

Figure 6.4: Structure of a puzzle with one key and one lock. The dashed line indicates which key unlocks what lock [5].

Above in Fig. 6.4, a basic ‘sentence’ is formed by the roots/words we introduced in section Graph Grammar Design. In part ‘a’, We start off with a linear mission from entrance/starting point to goal through several tasks that we assume the player is going to face and the quantity of tasks above is insignificant. In part ‘b’, a key and a lock are added to the formula to form a branching structure. In part ‘c’, the lock has been moved forward to form a tiny cycle. It is generally better to have the lock before the key for three reasons: [19]

1. When keys are encountered first, players will simply be forced to collect everything they encounter without discrimination, which creates rather simplistic gameplay.

2. With obstacles and items that act as locks and keys but are represented with something else, it is easier to recognize the key if players know what the lock is. Players then usually realize where they can proceed; they will actively formulate the intention to return to the lock.
3. When players can negotiate obstacles they were unable to get past earlier, they will experience progress and accomplishment.

With a simple move, the ‘sentence’ (structure of a pattern) is already flourished a bit. Thus, the move is a very important step, whereas a linear mission is very easy to specify yet does not necessarily make an entertaining level. Rules of positioning locks and keys introduce a certain degree of non-linearity. There are six rules so far introduced by Joris Dormans in his *Level Design as Model Transformation: A Strategy for Automated Content Generation*:



Rule 1: We’ve mentioned in Figure 4, part ‘b’: simple but necessary.

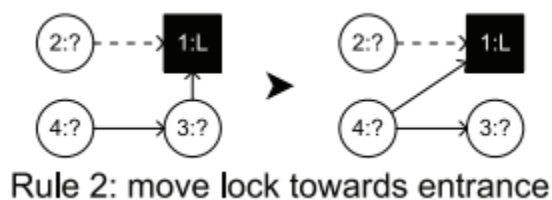

Rule 2: Mentioned in Figure 4, part ‘c’. This is a basic rule to generate non-linearity with the advantages we have talked about above.

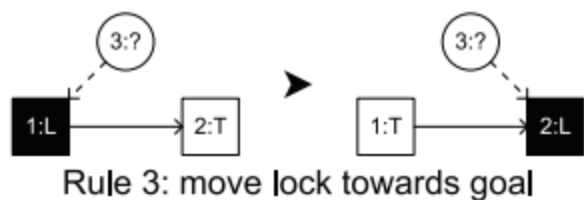

Rule 3: This is useful for a multi-locks scenario; it adds variety of the placement of locks.



Rule 4: This allows keys to pull tasks from behind a lock; in a sense, we hide the key to make certain that some significant tasks are accomplished.



Rule 5: This adds alternative options for players, especially in those what-we-call-hell levels.



Rule 6: This adds some degree of distraction, difficulty, or something beyond expectation.

6.3. Syntax

6.3.1. Pattern Integrity

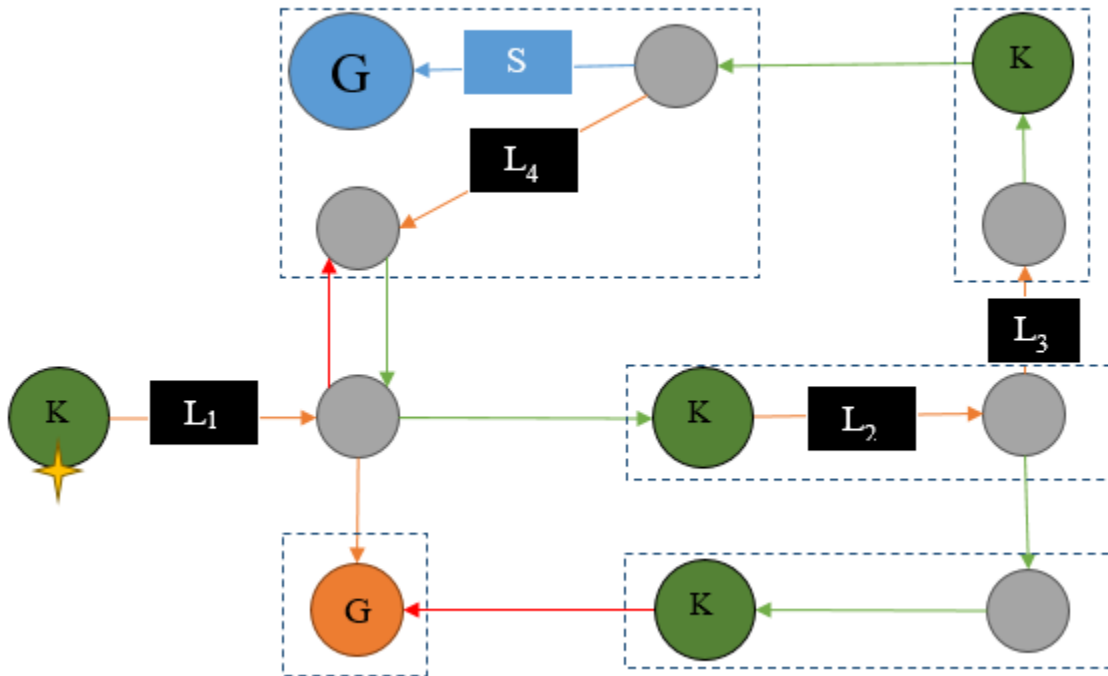

Figure 6.5: Overview of Game with Grammar

In Figure 6.5, we present an overview of a layout for our game with the grammar termination we introduced in previous sections. Combination of nodes, dashed boxes, symbols and arrows demonstrate the significant transitions for the game flow and basic layout which shows the relation between design flow chart and virtual space in the game. This will be discussed more in *Levels and Spaces* section. Below, we list out the elements in the graph:

- Dashed Box: a room/hall
- Yellow Star: starting point

- Cycle: a significant node that must have been passed during the game
 - Gray cycle: a node
 - Green cycle: a node with a key
 - Orange cycle: a node where the game ends normally
 - Blue cycle: a node where the game ends alternatively
- Arrow: a path signal that shows the transition from a node to another
 - Green arrow: a normal path which the player can pass along
 - Orange arrow: a locked path that requires a specific key to make feasible
 - Red arrow: an impassible path which yet provides the vague vision on the other side for the player to peek at
 - Blue arrow: a secret path that requires a special way to access
- Color-filled box: a component required for transition
 - Black box: lock
 - Blue box: hidden lock
- Letter: stands for itself; subscripted number means its identity and order
 - K: key
 - L: lock
 - S: secret lock
 - G: Goal

The list of elements represent the components of the designed layout (see Fig. 6.5) which helps map the grammar layout to the actual game layout (see Fig. 6.6) in section 6.3.2.

6.3.2. Levels and Spaces



Figure 6.6: Actual Map Layout with Design Grammar

Finally, we map our theoretical design to the physical layout of our game. As shown in Fig. 6.6, the nodes we mentioned in Figure 6.5 of Section 6.3.1 are corresponding to the places in the top-down-ish view of the palace. The blue dashed boxes are the areas that contain the building and environment. The colored cycles are the actual nodes that associate with puzzles, indicating which one is leading to another. Visually, the overall level design and virtual space are connected as a blueprint. In section 6.4, we discuss further about how we break down the blueprint into individual nodes visually and linguistically just like what we have been doing for the level so far.

6.4. Code Conduction

As the basis of our puzzle system is defined in section 6.2 and section 6.3, what is left is to execute to build up the architecture programmingly. In section, we briefly introduce the object structure, the pipeline based on the object structure, and finally the puzzle system.

6.4.1. Object Structure

Parent Class

InteractiveObject (see Fig. 6.7): A derivative from GameObject; parent class for other objects that work as puzzle pieces

- Acquire
- Activate
- Deactivate
- Self-Destruction

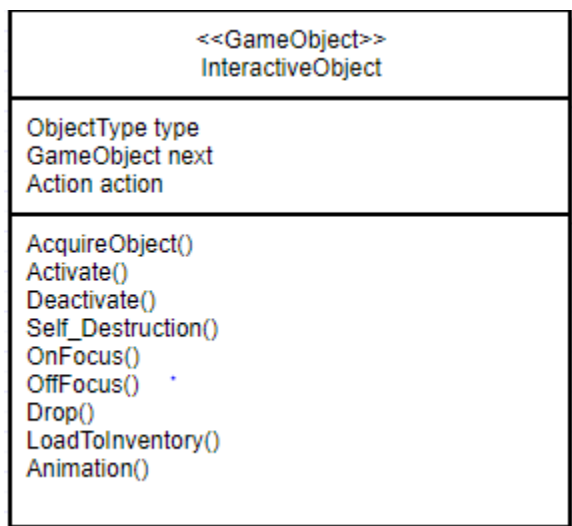

Figure 6.7: InteractiveObject Class

Derivatives from InteractiveObject (see Fig. 6.8)

AudioObject: An item that holds specific audio clip, usually activated to play the audio clip.

ConsumableObject: Anything would be destroyed after being acquired to, say, generate an item.

- Bag
- Pot
- Vase

DisplayObject: An item that exhibits some information like drawing; also have interactivity with the player which means the player is able to trigger it some way, such as:

- Lantern
- Painting
- Screen

FunctionalObject: An item that offers manipulation for the player to interact in order to fulfill specific functionality or needs.

- Locked box
- Compass
- Sinan (similar to ancient compass)
- Screen

HintObject: An item that only exhibits or animates, usually activated by bonded TriggerObject.

- Stone lion
- Keyhole
- Lantern

NarrativeObject: An item or in some cases a character that would trigger narrative system to display subtitles or the protagonist's self-talking.

- Letter
- Painting

- Girl

TransitionalObject: An item that animates the transitions between scenarios, objects, locations, and so.

- Door
- Fence
- Road lamp

TriggerObject: An item, sometimes invisible, that would activate bonded objects by certain mechanics like collision for instance.

- Collision box
- Lantern
- Painting

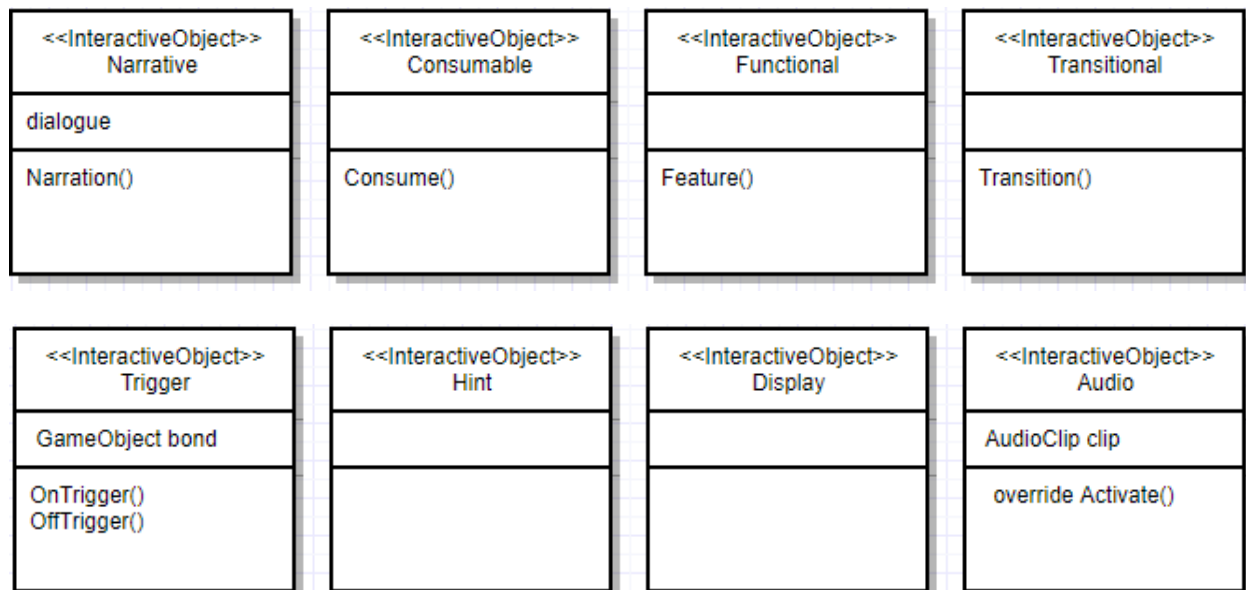

Figure 6.8: InteractiveObject Heritages

Item Actions

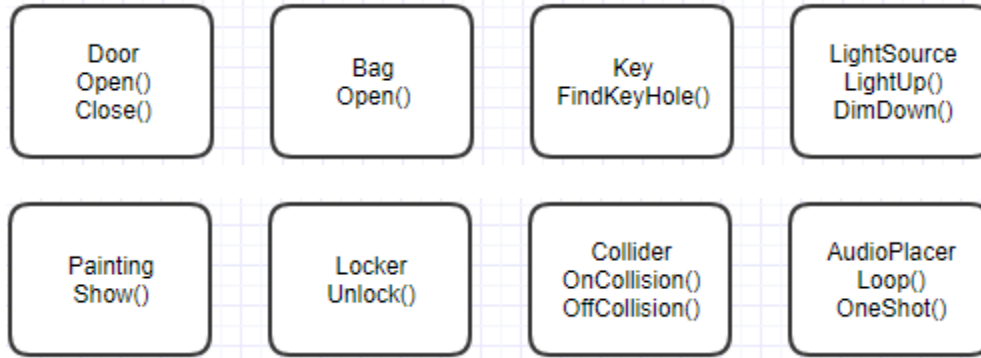

Figure 6.9: Item Actions Assigned to InteractiveObject

Fig. 6.9 shows some options of actions that can be assigned to InteractiveObject as its feature. For example, we may assign a Door action to a Transitional Object; the Transitional Object is attached to an in-game object, for instance a door shape. When the player uses a key on the door, the TransitionalObject program attached on the door is triggered to do the Door action which is to open.

6.4.2. Pipeline Structure

We all know more than one modern language consisting of the use of grammars and syntax formed by meaningful characters or words. Take English as example: we need to place the words in the right order to make a meaningful statement. That leads to our next step, which is to build the ‘order’ to make sense of the combination of interactive objects together. Now that we have object structure as the base of the whole architecture, or as we defined atomic pattern programming wise, we are then able to grammartize a puzzle off those atoms or characters programmably.

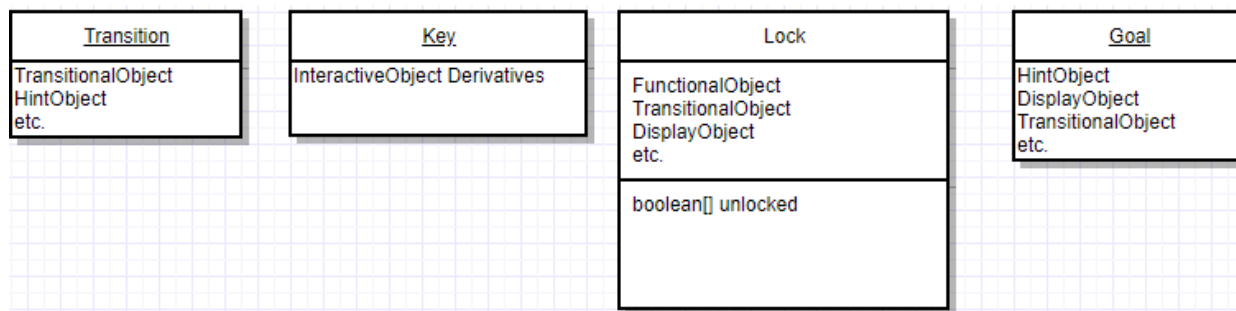

Figure 6.10: Puzzle Pieces

As shown above, our first step is to create words out of the characters, or the `InteractiveObject` Combinations, in which can form various kinds of terms, in our case `Key`, `Lock`, `Goal`, and `Transition`, in which they individually share their own feature amongst variety of combinations. By their literal meaning, `Key` will trigger a `Lock` to unlock through `transition` and then the `Lock` will reach the `Goal` via another correlated `transition`.

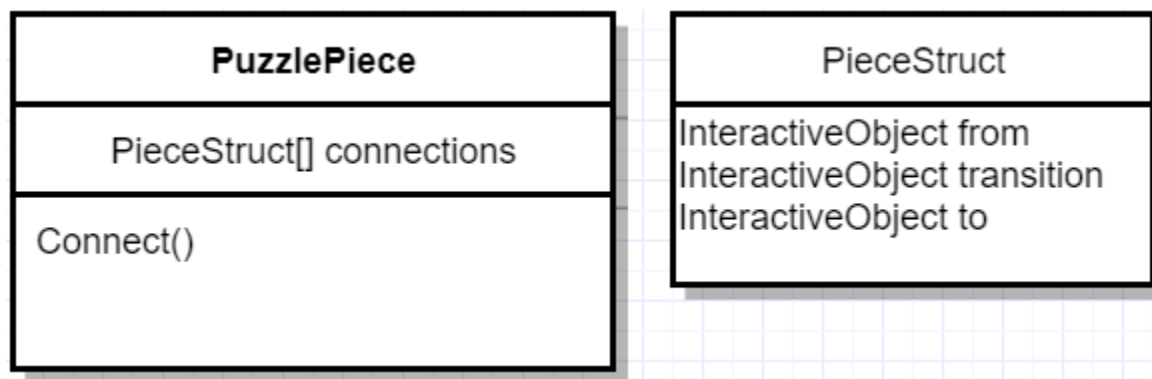

Figure 6.11: PuzzlePiece Class (left) and PieceStruct (right)

There, `PuzzlePiece` is defined to engender a phrase in a language, in this case as a part of a puzzle. Here, it contains several `PieceStructs` that show a singular connection each from one `InteractiveObject` to another. That is, a `Lock` is required for one or more keys to unlock and acquire single or multiple goals with their own transitions.

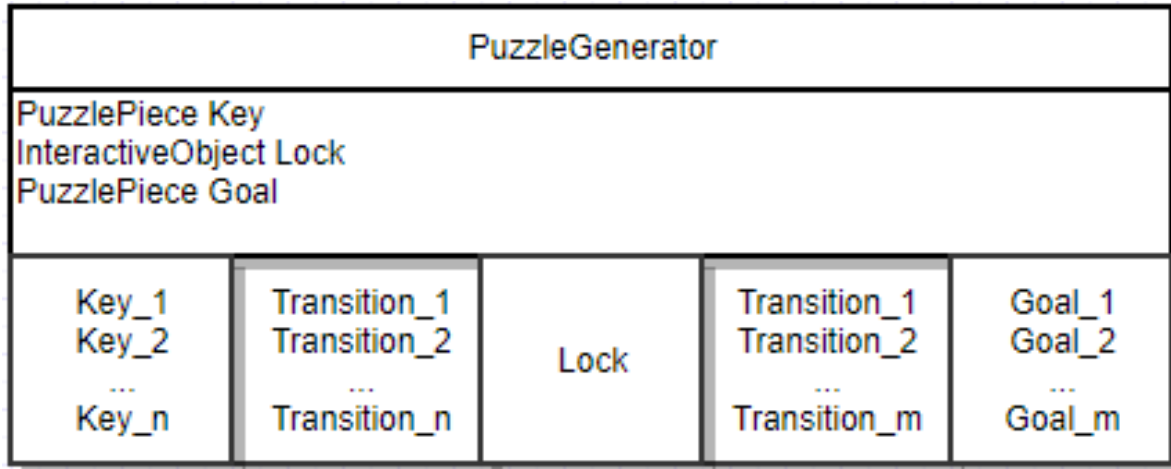

Figure 6.12: PuzzleGenerator Class

6.4.3. Hierarchy

With phrases and words defined, it now leaves us to construct a sentence that tells a story. Before getting into the construction, we will need connectors to bridge between words or phrases, by which we mean that small puzzles work result in puzzle pieces for larger puzzles.

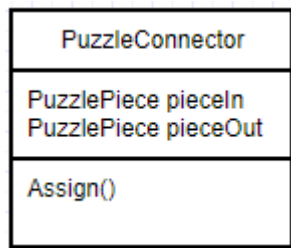

Figure 6.13: PuzzleConnector Class

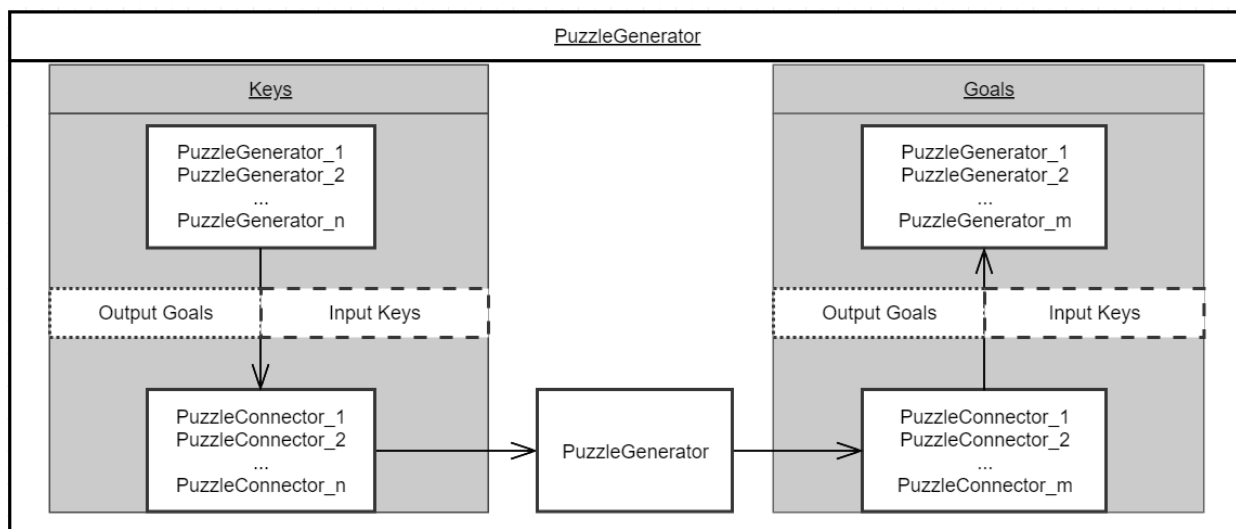

Figure 6.14: Flow of Multiple Puzzles to One Large Puzzle

Like the Fig. 6.12, a puzzle connector can take in any puzzle piece, identify it and then assign it to next connected puzzle generator. Thus, the puzzles can be linked together to form a larger puzzle in which the goals delivered by those linked puzzles are assigned to be keys to other puzzle generators, shown Fig. 6.13.

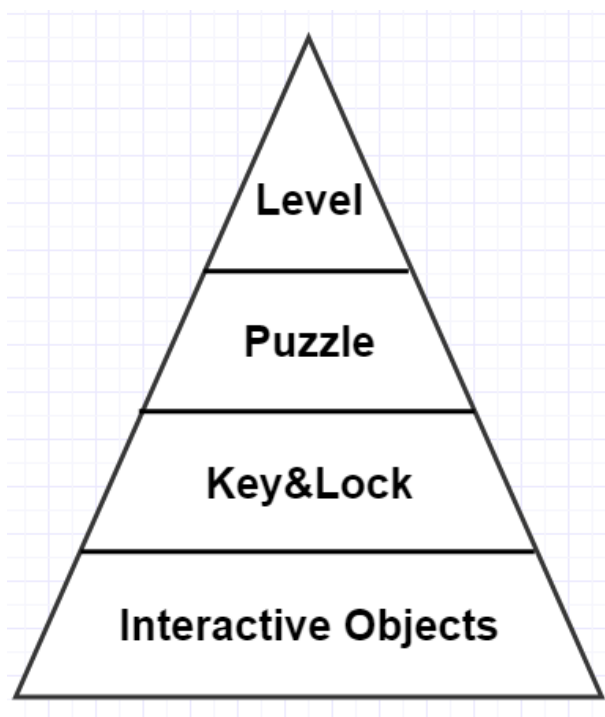

Figure 6.14: Puzzle Pyramid

Interactive objects take a role in key or lock; the key(s) and the lock can then form a puzzle; puzzles connect to build a level. In Fig. 6.14, it shows the pyramid of the hierarchy of the puzzle system.

6.5. VR Movement

When designing our game for VR, we had to look for ways to move inside the environment without the player suffering from heavy amounts of motion sickness. We analyzed different types of movement, for example, teleporting, point and walk, no movement at all and Xbox controlled movement. In the sections below, we will discuss each test used and why we picked the method of walking we picked.

6.5.1. Reticle Use in Virtual Reality

Reticles are present in most games, from first person shooters to MMO's. An article from Polygon discussed motion sickness in video games and how to combat it. When discussing about reticles, Binkowski said that "ICE placed a tiny dot in the center of the screen for its game, giving players one point to focus on while moving protagonist Faith through each parkour obstacle course. Techland has done the same for Dying Light (see Fig. 6.15), Binkowski said, and added a small dot to the center of the screen to help players maintain balance." [34]



Figure 6.15: Dying Light [34]

As stated based on most virtual reality experiences, the movement is always the major issue that breaks immersion at some extent. We decided to try out several movement options for our project: teleport, point and click to move, and no movement. Based on research result that a reticle would help players maintain balance and reduce motion sickness in games [3], we decide to add a reticle into our game to balance out the motion sickness. Though it might break immersion a little bit, we think it is worth trying, and it is a good trade-off to keep players in a good state of entertainment and focus. In addition to the current control system, the reticle helps the player to focus on the object that he or she wants to interact with.



Figure 6.16: The Lab in Virtual Reality [35]

The traditional way of moving in virtual reality consists of teleporting to a certain area. The reason for this is due to the high risk of motion sickness inside virtual reality. With this teleporting feature, it moves the player without actually moving, making the inner ear content. Games like The Lab and Rec Room use this teleporting as its main movement, to reducing motion sickness.



Figure 6.17. Rec Room [36]

6.5.2. Teleporting

Teleportation (see Fig. 6.18) being one of the most popular choices for movement in a virtual reality game, we started here. However, it quickly became apparent that this type of movement would not work for this type of game. For our game, we are trying to fully immerse the player with graphics, audio, and movement. With teleporting, it's impossible for a real human to teleport at will, therefore reminding the player they are only playing a game. Another reason for not including this method of movement was due to the possibility of teleporting over a trigger, and having missing data.

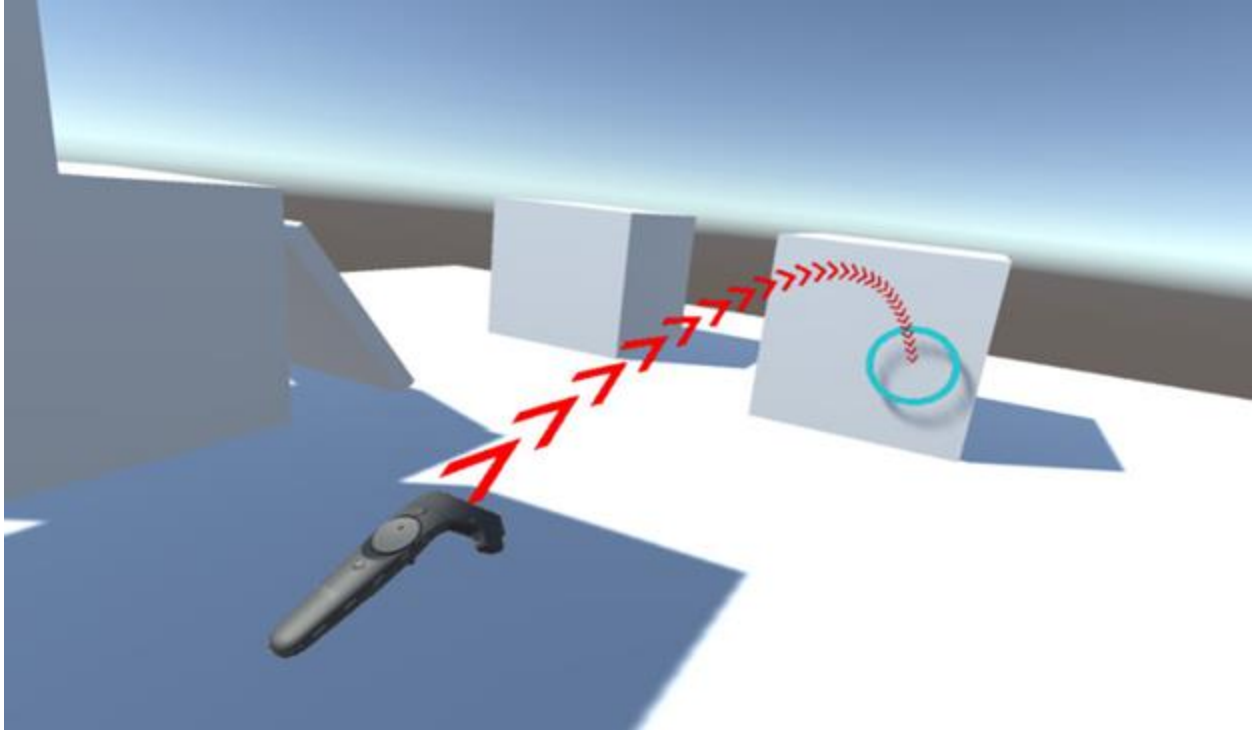

Figure 6.18. The Lab way of movement [38]

6.5.3. Point and Walk

With the point and walk type of movement (see Fig. 6.19), it would add that realism of walking, but would increase motion sickness with the user. In early trials, we tested the method of point and walk, in a small hallway with a few obstacles. After testing, we found this method to be motion sickness including, due to you moving in the game and not in real life. We adjusted speed of the walking and also added a reticle, which will be discussed later in the paper, but it felt disconnected from the player. With point and walk, you had this giant arc of the path you are going to take, taking up some of your screen. Regarding immersion, we felt this type of UI would destroy some of the immersion in the scene.

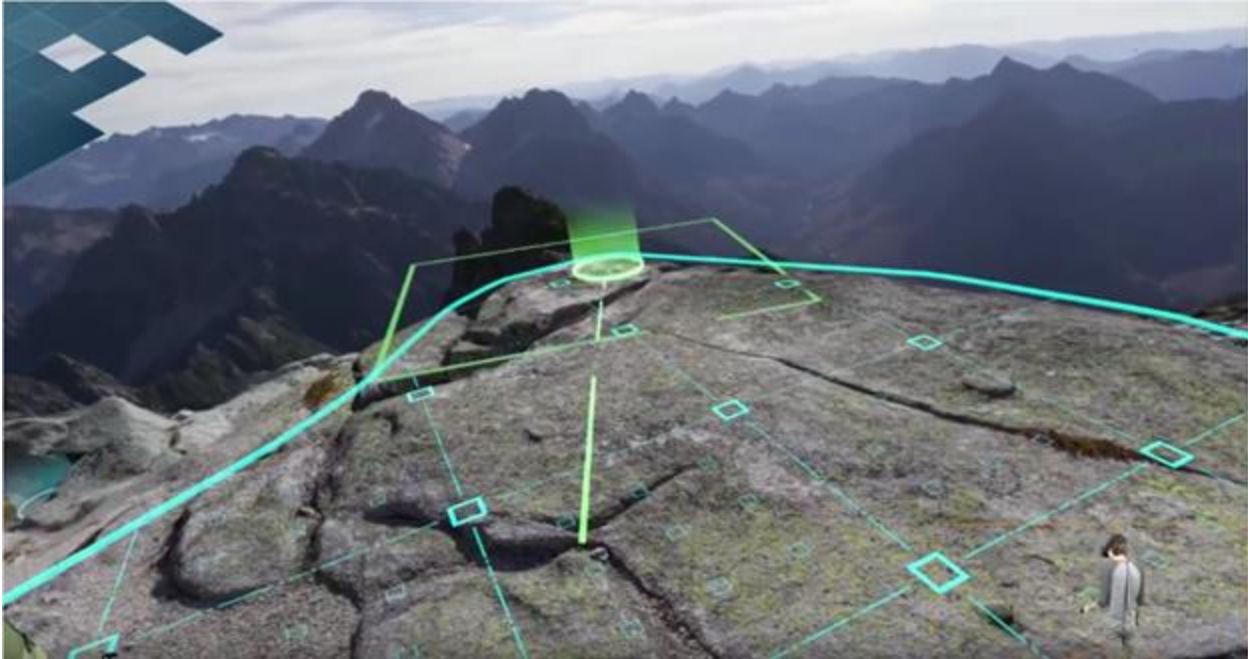

Figure 6.19: Point and Walk example [37]

6.5.4. No Movement

With no movement, the player is still allowed to move around in the borders defined by the lighthouses but that is it. Games with this type of movement have only one room and the main story plots occur in said room. Games like Job Simulator (see Fig. 6.20) take advantage of this, as the player role plays a person at a desk job. Early in our design, we were trying to eliminate all motion sickness and no movement came up. The game would only take place in one room, and the triggers would be there as well. However, after some thought, it was decided to be very limiting in nature. To have multiple triggers and a diverse environment, was one of the main goals of this project and only having one room destroyed that.



Figure 6.20: Job Simulator [39]

6.5.5. Xbox Controlled Movement

In our final game, we decided that Xbox controlled movement (see Fig. 6.21) is great for our game. With players controlling their movement by the analog stick, and their head pointing in certain directions, it created this unique mashup that worked. Some users from testing discussed in Chapter 7 did report minor motion sickness but a reticle was added to dim these effects. The movement seemed controlled without actually moving. We did notice, however, that there will always be disconnected with the player and movement, and only new technologies can attempt to tackle this issue.



Figure 6.21: Xbox control with VR [40]

6.6. UI Optimization

During our tests discussed in Chapter 7, we realized the feedback was not strong enough when players do some input. We optimized our UI to gaze-based navigation, assuming that our players would have limited or no input capability at all, by which we mean that the gazed object will be highlighted while being hovered over. In this way, players won't feel like they are falling into a black hole of button clicks or UI depth while browsing through the game.

Because the VR environment is pretty distracting, we improved our design to provide players with more feedback when they hover over something interactive. For example, when the player gets the key from the silk bag, an animation will appear with the movement of the key flying from the silk bag to the inventory icon, which indicates the player has added an item into

his or her inventory. This interactive feedback provides players the feeling of achievement and informs them that they can use the item in the inventory in a later stage.

Furthermore, the test result (Chapter 7) showed that having UI overlaying on viewport/camera (see Fig. 6.22) is really disorienting—very likely cause motion sickness. Plus, it does not look good or fit in in our game environment.



Figure 6.22: Game Scene with UI

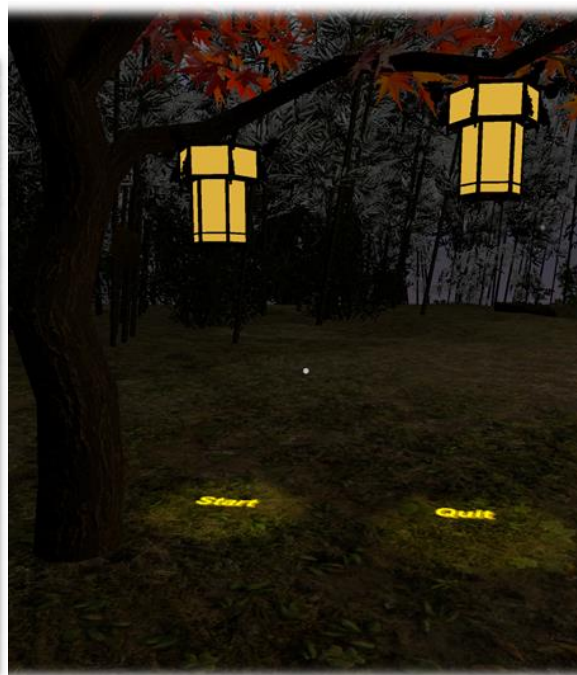

Figure 6.23: Game Scene with in-game UI

To solve the concern, we make the decision to build our UI system as game objects in game world, shown in Fig. 6.23. In this way, players wouldn't feel odd, and its appearance does not break the immersion too much.

7. Testing

Intro

We have 9 tests in total, which can be categorized into paper prototype test, digital prototype test, tutorial test, and alpha test.

Method

All the tests are carried out by questionnaires and discussions after playtesting the game.

Setup

There are two versions of the game—PC and VR version. For most of the time, we set up the test for the testers. During Alpha test, we sent PC builds to our two of the tester by email and they can start the executable file by themselves.

Table of Tests

	Index	Date	Participants	Set up	Elements
Paper Prototype (see Appendix)	1	02.17.2017	14 Male: 12 Female: 2	Paper	story
					gameplay
Digital Prototype (see Appendix)	2	03.02.2017	11 Male: 7 Female: 4	PC	movement
					control
					puzzles

				gameplay
				difficulty
				movement
				control
				puzzles
				difficulty
				art style
				movement
				control
				puzzles
				difficulty
				environment
				learning curve
				difficulty
				lighting
				VR environment
				VR movement
Tutorial Test	3	04.28.2017	9 Male: 6 Female: 3	PC
	4	07.07.2017	10 Male: 8 Female: 2	PC
	5	10.07.2017	7 Male: 4 Female: 3	PC
Alpha Test	6	12.14.2017	13 Male: 9	VR

		Female: 4		horror experience
				puzzles
				VR control
7	02.16.2018	9 Male: 8 Female: 1	VR	VR movement
				horror experience
				puzzles
				VR control
8	03.02.2018	20 Male:16 Female:4	VR	VR environment
				puzzles
				VR control
				UI

Story:

We tested the story in paper prototype test. Based on D&D (*Dungeons & Dragons*) tabletop style, players stated the actions or movements they would take as a game avatar; in return, we gave players printouts of object images and told them the clues as dungeon masters. The story in the palace was revealed partially. 14 players participated in our test, 13 of whom

liked the story very much. 1 player suggested the story could be developed with different endings.

Gameplay:

We tested gameplay in both paper prototype and digital prototype. In terms of gameplay, we wanted to get players' overall feeling about the combination of Eastern horror, puzzle, and Asian environment, which is very new to the market in Western countries and has the potential to start a new genre. We are glad to see that the result was positive.

Movement:

We had movement tested in digital prototype. The speed was set to 8f (float number indicates 8 units per second in game scale) for moving forward, afterward, left, and right. However, many testers reported that it was too fast for them to see the surroundings clearly enough when they were moving around. We modified the speed and set it to 4f for movement. In the test we took on April 28th, 2017, the speed for moving forward and afterward was fine. However, it was still too sensitive when moving left and right; the displacement is too wide to be accurate enough when the player is gazing at some point. We addressed the issue in section of VR Movement.

Game Control:

Game control was tested in digital prototype. We tested with Xbox controller, and observed how the testers touch items, pick up items, hold items, drop items, and move items. Game control worked well during test, all the testers had no problem with controlling the objects

in the game. The only problem was that testers, who were not familiar with Xbox controller, would spend more time on learning how to use it.

Puzzles:

We tested puzzles in both digital prototype and Alpha test. During digital prototype test, we only tested the third room puzzles including hidden objects, Chinese character interpretations of 日 (the sun) and 月 (the moon), and Chinese character formation with a combination of two—a new character: 明 (meaning ‘bright’). In our Alpha test, we tested more puzzles (tutorial puzzles, key-to-lock puzzles, Chinese character recognitions, etc.). For easier puzzles such as finding a key and unlocking a box, players had no problem. In later stage when the puzzles were more difficult, half of the testers could not figure it out. This fulfilled our expectation, which means that the puzzle difficulty is at reasonable level.

Difficulty & Learning curve:

Game difficulty and learning curve were tested in tutorial level test. According to the digital prototype test feedback, our puzzles were a bit too difficult, we adjusted our tutorial level and made it just as easy as players can learn how puzzles work after skimming through. At the same time, we redesigned our puzzles to adapt the learning curve by using similar puzzle mechanic over and over with little extra features gradually.

Art style:

Art style was tested in digital prototype tests. We use realistic art which provides better horror experience and immersion when playing in VR environment. During the tests, all the testers loved the ancient Chinese architecture and Chinese elements in the game.

Environment:

Environment was tested in digital prototype tests. Our goal was to test whether the game map was fine: whether the environment matches the game theme. During the test, all the testers loved the design of the palace, the red trees, the letter, the paintings and other objects matched the game theme.

Horror experience:

Horror experience was tested in Alpha test. Our goal was to test the extent of horror when players were playing in VR environment. We tested the tutorial level and the first level, most of testers didn't feel that horror. Neither the audio nor the character was that spooky enough. We added more horror elements in like female moaning sound, peripheral images, and so forth. Unfortunately, the new add-ins have not been tested yet.

Lighting:

Lighting was tested in tutorial test. The goal was to test whether the light in the game was good enough to create the feeling of darkness, isolation and reasonable horror. Two third of testers responded that the lighting worked well and was close the theme. One third testers said the lighting was a bit too bright, and the light in the front door was too dark so they were not

easy to see the ground clearly. According to the feedback, we adjusted the light to make it dimmer, and added more point lights in the front door.

VR movement:

VR movement was tested in the Alpha test. The goal was to test the movement speed when players were playing in VR environment. As what we talked in game movement test, we set the speed to 4f when moving forward and afterward, and set the speed to 2f when moving left and right. During the test, all the testers replied the movement was good: neither too fast nor too slow. As a result, we keep the movement speed in the game.

UI and subtitle:

User interface and subtitle were tested in Alpha test. The goal was to test whether the UI was clear enough to provide essential information. During the test, all the testers replied that the UI was clear. However, the subtitle was not user-friendly because the font was small. We did not address the concern. Instead, we had a different approach to show UI and subtitles discussed in section 6.6 UI Optimization.

8. Post Mortem

Project overview

Our original project goal was to develop a game and publish it on Steam or Google Daydream. Both of us love puzzle games, and we did research on VR games before we started our project. Google daydream is a new VR platform, which could help players get access to VR game with low cost, and there are only a few puzzle games available on this platform. As a result, it is possible that we could get more attention from and the audience if we could finish the game by the time we graduated.

Key Accomplishments

1. Time Management

We were clear with game development process and the time schedule. This is the reason we finished our digital prototype quite ahead of time. As soon as we got our concept approved, we started work on our paper prototype and digital prototype. Another reason that motivated us to start early was that we are not art students, and art is an essential part of our game. So we solidified the art style in time and started to work on both art and coding.

2. Game Iterations

We had a lot of game iterations during our game development process, including iterations to our game story, game environment, puzzles, and tutorial level. For our game environment iterations, we initially built a palace. However, we realized later the palace was too spacious and would not

provide the player the feeling of isolation and being haunted. We redesigned the palace according to the feedback we received and made the palace more narrow and restricted. However, the palace looked too much like a garden at that time. In our third redesign, we based it on our former experiences, and the palace looks good now. Our iterations of game process provided us a lot of innovative ideas.

3. Tests and Activities

We had nine tests in total, and we got many suggestions after each test. Some tests were conducted off campus, such as at the MassDIGI game challenge, where we received a lot of feedback from game professionals. That feedback informed our ideas about puzzle design. Furthermore, it was useful for us to learn from other players about their thoughts about in-game activities.

4. Former research

Before we started the game, we researched both puzzles and VR games. After playing a number of games with similarities, we found that we identified a viable target audience who is interested in this type of VR game. We also did research on how to create art assets with low costs so that we could get the appropriate number of assets for our game during development. Though we had a hard time in finding proper assets, we tried our best to modify existing assets for our purposes. Neither of us are character animators; nevertheless, we tried to use code to control the animation. Without former research, there is great possibility that we may have given up many aspects of our creative design.

5. Familiarity

Taking advantage of our nationality, we found it easier for us to create an authentic Chinese environment and East Asian horror. Our own life experiences in China empower us to think and brainstorm about the type of story, environment, and experiences we want to create.

6. Different approaches

During the development process, we encountered different problems, and we tried our best to solve the problems with various approaches. A good example is the in-game user interface. The first time we designed the UI, it was similar to ones that we had developed for PC or mobile games—all the buttons for instruction and inventory were flat and attached to the camera. We realized this would break immersion when player was playing in VR, and we eventually redesigned the UI. The second approach was when we put a table in the palace—all the items in the inventory were on the table for players to browse and manipulate. However, we found that limiting players to manipulate one object at a time and restricted players' ability to move quickly and carry objects. The third time, we put the UI on the objects in the game environment, which players could easily access.

7. Find help in time

As we mentioned earlier, we are not good at modeling or making animations. We asked Prof. Sutter for help early in the process, and he provided us many suggestions. During our development of game story design and puzzle design, Prof deWinter offered us with tons of brilliant suggestions. Without both of these faculty offering their time and expertise, we might still be struggling on our development process.

8. Blog to keep footage

During our year-and-a-half development, we had a lot iterations of our game. We created and maintained a developer's blog, which helped us record our design process. When we took a couple of steps back to see the history, we were able to get more ideas on how to bring the game to another level.

Things Could've Done Better

1. Scope too big

When we look back to our original goal, we realize we scoped too big. 3D game development usually takes more time than 2D development, especially in art and environment design. We only had two members on our team and one year to develop the whole game; however, we set the goal too big, which created a lot of anxiety during the design process. If we had a chance, we would like to set an achievable goal first and polish it with the rest of time.

2. Shortage of artists

Originally, we thought we could use some free assets or purchase some assets. However, we found that realistic ancient Chinese environmental assets are fairly rare. There are some puzzles we wanted to build on ancient origami, and yet we couldn't find any assets that were close to what we wanted, and it was hard for us to model. At last, we had to give up this puzzle design. The lack of art assets necessarily restricted our puzzle design.

3. User Interface: lack of research

UI design in VR game is a new field. We decided to transfer what we knew about traditional flat UI design to a 3D immersive environment, and it failed hard. It was not until we researched VR games that we were inspired to place the UI on game objects. It could have saved us a lot of time if we had found this solution earlier.

4. Started the MS report late

We spent most of the time on game development and started working on the document a bit late, which made us almost miss the deadline.

Future development

1. Level, more chapters, puzzle design

We intend to release and sell *The Palace of Monarch* episodically. Our game works well for this because the palace contains multiple rooms with undiscovered stories and puzzles. In this case, we are in definite need of further development of levels, stories, art assets, and puzzles. Despite the Suzhou Garden design for potential levels after the palace, we still have plenty of space in the palace itself for at least two or three episodes more.

2. Character design: model, animation, object modeling

3D modeling and animation are underdeveloped when compared to other aspects of the development. That said, we are seeing a tremendous potential for improved aesthetic development. We are debating on whether the female ghostly character should be implemented, and we have put ourselves in this dilemma because of the shortage of skill sets in character

design and modelling. If financially feasible, we are certainly planning on refining our environmental details and game character development.

3. Audio

Similar situations occurred in audio. With two people taking multiple roles in a large-scaled game, we are in urgent need of various skill sets, which include audio and sound design. Current sound effects and music in use are online free assets and/or our nonprofessional recording. Again, it would be better to address this issue when we are financially capable of doing so.

4. Adaptive curve

Adaptive curve is one of our earlier designs that puzzles and environments would adjust accordingly based on the performance of players. With the time constraint, we decided to deprioritize the implementation of adaptive curve. Nevertheless, this is surely worth implementing in our game at a later date.

5. Lighting

There is still a lot of room for lighting to improve since the lighting we have right now is very basic. In the Unity Engine, lighting is simple but limited. To further develop the ambiance in our environmental design, we need to dive deeper into the technical aspects of using graphical cards and shader development. With this implemented, the lighting will take the game to another level visually and aesthetically.

6. Horror Aspect

Horror, as one of our major experience goals, can always be elevated. With 3d modeling, lighting, and audio all combined, the horror experience will become more intense. In addition, we can include more design derived from psychological research involves horror. To do so, we will need to learn and go over a great amount of relevant media to understand and refresh the concepts over and over.

References

- [1]. El-Nasr, M. S. (2007). Interaction, narrative, and drama: Creating an adaptive interactive narrative using performance arts theories. *Interaction Studies*, 8(2), 209-240.
- [2]. Jennifer Feeley (2012) Transnational spectres and regional spectators: Flexible citizenship in new Chinese horror cinema, *Journal of Chinese Cinemas*, 6:1, 41-64.
- [3]. O'Hara, Jessica (01/01/2010). "Making Their Presence Known: TV's Ghost-Hunter Phenomenon in a 'Post-' World" in *The Philosophy of Horror (0-8131-2573-1, 978-0-8131-2573-2)*, (p. 72).
- [4]. Li, Zeng (2009). "Horror Returns to Chinese Cinema: An Aesthetic of Restraint and the Space of Horror". *Jump cut(0146-5546)*, 51.
- [5]. Guang, H., Bai, W., & Zhang, S. (2015). Simulation research for android platform based on Unity3D. Paper presented at the 1922-1925. doi:10.1109/CGNCC.2014.7007473.
- [6]. Hong, Guang, Bai, Weibing, Zhang, Shuai, "Simulation research for Android platform based on Unity3D", *Guidance Navigation and Control Conference (CGNCC) 2014 IEEE Chinese*, pp. 1922-1925, 2014.
- [7]. 汉字文化. "汉字看图识字入门——给外国朋友和小学一年级老师." *新浪博客*. N.p., 1 Dec. 2008. Web. 13 Mar. 2017.
- [8]. Hor, Lily. "Ancient Chinese Beauty." *Pinterest*. N.p., 29 Nov. 2016. Web. 23 Mar. 2017.
- [9]. "大宅院图片." *Nipic*. N.p., n.d. Web. 24 Mar. 2017.
<<http://www.nipic.com/show/1/38/d8808f8fce69efdf.html>>.
- [10]. "室内设计发展史" 学尔森教育. N.p., Web. 24 Mar. 2017.
<<http://www.shsunedu.com/xm/baike-1886.html>>
- [11]. Omid Abari, Dinesh Bharadia, Austin Duffield, and Dina Katabi. 2016. Cutting the Cord in Virtual Reality. In *Proceedings of the 15th ACM Workshop on Hot Topics in Networks (HotNets '16)*.
- [12]. "阴阳五行和八卦理论" 中国道教网. N.p., Web. 28 Mar. 2014. 26 Mar. 2017
<<http://www.wuwo.org/djwh/djwhh/827.html>>
- [13]. "曼珠沙华." *课堂内外: 初中版* (2008): 50-51. *中文科技期刊数据库*. Web. 29 Mar. 2017. <<http://www.cqvip.com/qk/80808x/200802/26446284.html>>.
- [14]. Carson, D. (2000). Environmental storytelling: Creating immersive 3D worlds using lessons learned from the theme park industry. *Gamasutra*, [Online] Available: http://www.gamasutra.com/features/20000301/carson_pfv.htm
- [15]. Dormans, Joris. "A Handcrafted Feel: 'Unexplored' Explores Cyclic Dungeon Generation." *CONTROL500*, 31 May 2017, [ctrl500.com/tech/handcrafted-feel-dungeon-generation/](http://ctrl500.com/tech/handcrafted-feel-dungeon-generation-unexplored-explores-cyclic-dungeon-generation/).
- [16]. Joris Dormans, Adventures in level design: generating missions and spaces for action adventure games, *Proceedings of the 2010 Workshop on Procedural Content Generation in Games*, p.1-8, June 18-18, 2010, Monterey, California

- [17]. Adams, David. 2002. Automatic Generation of Dungeons for Computer Games. Bachelor thesis, University of Sheffield, UK. DOI=
<http://www.dcs.shef.ac.uk/intranet/teaching/projects/archive/ug2002/pdf/u9da.pdf>
- [18]. N. Chomsky. Language and Mind, Enlarged Edition. Harcourt Brace Jovanovich Inc, New York, NY, 1972.
- [19]. Joris Dormans, Level design as model transformation: a strategy for automated content generation, Proceedings of the 2nd International Workshop on Procedural Content Generation in Games, p.1-8, June 28-28, 2011, Bordeaux, France
- [20]. Jun, Jia. "Architecture in the Gardens of Suzhou." *The Gardens of Suzhou*, doi:10.9783/9780812207255.21.
- [21]. Cui, Huaizu, and Qingqing Hu. "Creation and Appreciation of 'Nature and Man in One' and Chinese Classic Beauty of Garden – Taking the Suzhou Classic Garden as an Example." *SHS Web of Conferences*, vol. 17, 2015, p. 02001., doi:10.1051/shsconf/20151702001.
- [22]. Lu, Yuqi, and Zhixiang She. "Regional Effects by the Construction of Suzhou Industry Garden." *Chinese Geographical Science*, vol. 9, no. 4, 1999, pp. 342–349., doi:10.1007/s11769-999-0008-1.
- [23]. Krzywinska, Tanya. "Gaming Horror's Horror: Representation, Regulation, and Affect in Survival Horror Videogames." *Journal of Visual Culture*, vol. 14, no. 3, 3 Dec. 2015, pp. 293–297., doi:10.1177/1470412915607924.
- [24]. Chad Habel & Ben Kooyman (2013) Agency mechanics: gameplay design in survival horror video games, *Digital Creativity*, 25:1, 1-14, DOI: 10.1080/14626268.2013.776971
- [25]. Perron, Bernard (2004). « Sign of a Threat : The Effects of Warning Systems in Survival Horror Games», COSIGN 2004 Proceedings, Art Academy, University of Split, 2004, p. 132-141, available online : <<http://www.cosignconference.org/cosign2004/papers/Perron.pdf>>.
- [26]. Grimshaw, Mark. "Listening to Fear." *Game Sound Technology and Player Interaction: Concepts and Developments*, Information Science Reference, 2011, pp. 192–201.
- [27]. "TN Games | shop." *TN Games | shop*. N.p., n.d. Web. 13 Feb. 2017.
- [28]. Kyle E. Madsen. (2016) The differential effects of agency on fear induction using a horror-themed video game. *Computers in Human Behavior* 56, pages 142-146.
- [29]. 明朝妇女服饰 [online image]. Retrieved Dec 5, 2017. from <http://www.sleepinganimals/pix.com>
- [30]. Chen, Li-fang and Siang-li Yu. *The Garden Art of China*. Portland, Oregon: Timber Press 1986. 9. History of Chinese Classical Architecture. Ed. Dun-zhen Liu. 2nd ed. Beijing, China: China Building Industry Press, 1984. 85 - 86.
- [31]. Feng, zhong-ping. *Chinese Garden Architecture*. Ed. Zhong-ping Feng. 1st ed. Beijing, China: Qinghua University Press, 1988. 8-9.
- [32]. Feng, Zhong-ping. *Chinese Garden Architecture*. Ed. Zhong-ping Feng. 1st ed. Beijing, China: Qinghua University Press, 1988. 7.

- [33]. Gaming. "Six Elements That Make For A Quality Survival Horror Game." *The Federalist*, 9 Mar. 2015, thefederalist.com/2015/03/03/six-elements-that-make-for-a-quality-survival-horror-game/.
- [34]. Dying light [online image]. Retrieved Nov 5, 2017. from <http://www.ign.com/images/games/dying-light-the-following-enhanced-edition-ps4-20047451/539617c8471dddc1c2ea0c0>
- [35]. The lab [online image]. Retrieved Nov 5, 2017. from https://store.steampowered.com/app/450390/The_Lab/
- [36]. Rec room [online image]. Retrieved Nov 5, 2017. from <http://virtualrealitysummit.com/news/rec-room-social-vr-app-creator-raises-5-million/42039/>
- [37]. Point and move [online image]. Retrieved Nov 5, 2017. from <https://forums.autodesk.com/t5/stingray-forum/htc-vive-template-vr-steam-teleportation/td-p/6362214>
- [38]. Teleportation [online image]. Retrieved Nov 5, 2017. from <https://assetstore.unity.com/packages/3d/characters/vr-arc-teleporter-61561>
- [39]. Job simulator [online image]. Retrieved Nov 5, 2017. from https://store.steampowered.com/app/448280/Job_Simulator/
- [40]. Xbox controller [online image]. Retrieved Nov 5, 2017. from <https://www.express.co.uk/entertainment/gaming/815906/Xbox-One-X-news-Microsoft-VR-virtual-reality-Oculus-wireless>

Appendix

Paper Prototype



Digital Prototype



Questionnaire

Pre-test questions:

1. Have you played puzzle games before?
2. What's your experience of puzzle games in scale of 0-10?
3. What is your familiarity with Chinese language in scale of 0-10?
4. What is your familiarity with Chinese culture in scale of 0-10?

Post-test questions:

1. Did you feel the game too long, short, or just right in scale of 0-10?
2. Was the objectives clear at all times in scale of 0-10?
3. Were the procedures and rules easy to understand in scale of 0-10?
4. Was the game interface clear in scale of 0-10?
5. What is the difficulty of the game in scale of 0-10?
6. Overall, how would you describe the game's art style? From bad to excellent in scale of 0-10.
7. Was the game fun to play in scale of 0-10?
8. How did the controls/movement feel in scale of 0-10?
9. What elements of the game attracted you?
10. Did anything feel awkward, clunky or confusing?
11. If you could change just one thing of the game, what would it be?
12. Did you find any loopholes in the game?
13. Were there particular aspects that you found satisfying?