



WPI

Design of a Shoulder Pad to Reduce the Risk of Injury in Men's Lacrosse

A Major Qualifying Project Report
submitted to the Faculty of
WORCESTER POLYTECHNIC INSTITUTE
in partial fulfillment of the requirements for the
Degree of Bachelor Science
in Mechanical Engineering

Submitted by:

Elianna Buckley

Juliana Cabello

Tristin Carlton

Gabriela Hoops

Project Advisor:

Professor Fiona Levey

Date of Submission:

24 April 2019

Abstract

Many shoulder injuries occur as a result of player-to-player contact in collegiate men's lacrosse despite the required protective equipment mandated by the NCAA. There are currently no standards for lacrosse shoulder pads, and current shoulder pad designs do not provide sufficient coverage to the entire shoulder. We developed a design aimed to maximize both protection and mobility. Our prototype consisted of a dual-layer protection system encompassed in a compression layer to ensure a snug fit during play. Impact tests were conducted using a pendulum testing rig, and comfort and mobility were assessed by surveying college lacrosse players. During a low, medium, and high impact test our pad reduced the g-force experienced by 46%, 24%, and 41%, respectively, while not limiting overhead and lateral range of motion by more than 2.5%.

Table of Contents

Abstract	2
Table of Contents	3
List of Figures	5
List of Tables	7
Introduction	8
Literature Review	9
The Game of Lacrosse	9
Risks in Lacrosse	9
Anatomy of Shoulder	11
Bones and Joints	12
Muscles, Ligaments, and Tendons	12
Lacrosse Shoulder Injuries	12
Forces of Injury In Lacrosse	13
Lacrosse Shoulder and Chest Protection	14
Popular Protective Pads on Market	15
Testing Methods for Equipment	16
Methodology	17
Developing a Design	17
Objectives	17
Forces of Impact	17
Performance Standards	18
Preliminary Design	19
Final Design	21
Placement of Protection	22
Material Choice	23
Design Components	25
Developing a Testing Method	29
Modeling Testing Rig	29
Relevancy	30
Applied Calculations	34
Prototype	36

Testing	37
Pads Tested	37
Pendulum Rig Setup	38
Lacrosse Team Survey	39
Results and Analysis	41
Pendulum Test	41
Pendulum Applied Calculations	47
Lacrosse Team Survey	48
Discussion	52
Conclusion & Recommendations	55
Recommendations	56
References	57
Appendices	59
Appendix A: Dimension of Our Shoulder Pad	59
Appendix B: Safety Guidelines for Pendulum Testings	64
Appendix C: Informed Consent Agreement for Participation in a Study	65
Appendix D: Lacrosse Pad Performance Study	67

List of Figures

- [Figure 1: Injury Mechanisms in Men's Lacrosse](#)
- [Figure 2: Bones and Joints of the Shoulder](#)
- [Figure 3: Impact Force Vector Representation of a Direct Blow to the Shoulder](#)
- [Figure 4: Maverik Rome RX3 Shoulder Pad \(left\) and Max Liner \(right\)](#)
- [Figure 5: Contact Load Location](#)
- [Figure 6: Key Impact Zones with Labeled Anatomy](#)
- [Figure 7: Sample Brainstorm Designs](#)
- [Figure 8: Sketch of Preliminary Design](#)
- [Figure 9: Layer Placement for Final Design](#)
- [Figure 10: Dimensions & Configurations \(Left-Front View, Right-Back View...](#)
- [Figure 11: Layers of Shoulder Pad Design](#)
- [Figure 12: Front Protection: Layers 2 & 3](#)
- [Figure 13: Back Protection: Layers 2 & 3](#)
- [Figure 14: Shoulder Protection Side View: Layers 2 & 3](#)
- [Figure 15: Testing Rig and Dummy Demonstration](#)
- [Figure 16: Assembled Dummy](#)
- [Figure 17: Prototype Design](#)
- [Figure 18: Accelerometer Orientation](#)
- [Figure 19: Sequential Shots of Contact](#)
- [Figure 20: Acceleration Experienced by the Dummy During Impact](#)
- [Figure 21: Average Z-Acceleration During Low Impact](#)
- [Figure 22: Low Impact Testing Data Trends at Z-Acceleration Maximum](#)
- [Figure 23: Low Impact Testing Data Trends at Z-Acceleration Minimum](#)
- [Figure 24: Average Z-Acceleration During Medium Impact](#)

[Figure 25: Medium Impact Testing Data Trends at Z-Acceleration Maximum](#)

[Figure 26: Medium Impact Testing Data Trends at Z-Acceleration Minimum](#)

[Figure 27: Average Z-Acceleration During High Impact](#)

[Figure 28: High Impact Testing Data Trends at Z-Acceleration Maximum](#)

[Figure 29: High Impact Testing Data Trends at Z-Acceleration Minimum](#)

[Figure 30: Pad with Least Perceived Effect on Range of Motion](#)

[Figure 31: Our Pad's Perceived Effects on Ranges of Motion](#)

[Figure 32: The Most Comfortable Pad](#)

List of Tables

[Table 1: Tabulated Data from Epidemiology](#)

[Table 2: Contact Loads](#)

[Table 3: Design Specifications](#)

[Table 4: Design Matrix](#)

[Table 5: XRD® Material Breakdown](#)

[Table 6: Foam Configurations](#)

[Table 7: Hard Plastic Shell Configurations](#)

[Table 8: General Equations](#)

[Table 9: Test Dummy Design](#)

[Table 10: Applied Calculations](#)

[Table 11: Experimental Matrix](#)

[Table 12: Three Pads Tested](#)

[Table 13: Accelerations Experienced by the Pads Relative to the Baseline](#)

[Table 14: Participant's Range of Motion \(Degrees Lost\)](#)

[Table 15: Recorded Time of Each Participant](#)

Introduction

Lacrosse is one of the fastest growing sports in the United States. With the exception of the helmet, protective lacrosse equipment has not evolved significantly over the last 30 years. Many injuries occur in collegiate men's lacrosse despite the required equipment mandated by the NCAA. Shoulder injuries are the leading injury that results from player-to-player contact, keeping players off the field. Few, if any, current shoulder pad designs provide sufficient coverage to the entire shoulder. Consequently, these shoulder pads fail to dissipate the impact energy from a direct blow. Acromioclavicular (AC) injuries are the most common shoulder injury in men's lacrosse and are the second highest on the list of injuries that keep players out for more than 10 days. A severe shoulder injury, such as a clavicle (collarbone) fracture, will typically keep a player out for the remainder of the season and may require surgery depending on its severity. While variations of shoulder pads exist, many manufacturers focus on mobility, leaving athletes susceptible to contact related injuries and causing players to miss games and entire seasons. The goal of this project was to design, prototype, and test a lacrosse shoulder pad that would offer male lacrosse players sufficient shoulder protection while not impeding mobility, allowing them to perform at their full potential.

Literature Review

The Game of Lacrosse

Beginning as a cultural tradition of the Iroquois as early as the 17th century, lacrosse has seen explosive growth with participation increasing by 225% over a 15-year timeframe [1]. Modern lacrosse is a fast-paced sport involving two teams of ten players (including a goalkeeper) competing to throw a solid rubber ball into the opposing team's goal as many times as possible using sticks with nets [2].

Men's and women's lacrosse have vastly different rules. The primary distinction between men's and women's lacrosse is checking, which is defined as the act of attempting to dislodge the ball from an opponent's stick. In men's lacrosse, rules allow for stick and body checking, whereas in women's lacrosse, individuals are limited solely to stick checking. This permitted contact makes men's lacrosse a higher contact sport, generating dangerous play, mandating increased protection. A further variation within men's lacrosse is box lacrosse, which is played in a closed box arena rather than on a field. For this project, we are focused solely on field lacrosse. Field players in men's lacrosse are required to wear the following equipment gear: a helmet with full face guards, shoulder and arm/elbow pads, padded gloves, and a mouthpiece. Field players in women's lacrosse are only required to wear protective eyewear and a mouthpiece [2]. The equipment worn to minimize and/or prevent harm during play characterizes injury epidemiology in men's lacrosse.

Risks in Lacrosse

Lacrosse falls under the category of a collision sport, similar to football, hockey, and rugby, where contact with other players is a designed part of the game. The rules allow for contact existing in the form of player-to-player, stick-to-player, and player-to-ground, all which leave the athlete susceptible to injury.

Knee and ankle injuries tend to be the most common in lacrosse and are often due to running and overuse. Upper body injuries including the shoulder, elbow, wrist, and hand account for 26.2% of men's collegiate lacrosse injuries and a majority are caused by contact [3]. Of all the most common injuries to each body part, only the shoulder is commonly caused by

player-to-player contact [3]. As seen in [Figure 1](#) below, player contact is the leading mechanism of injury in men's lacrosse games. "Other contact" refers to contact with items such as balls, sticks, or the ground. The injury mechanism was unavailable for 1% of game injuries and 3% of practice injuries.

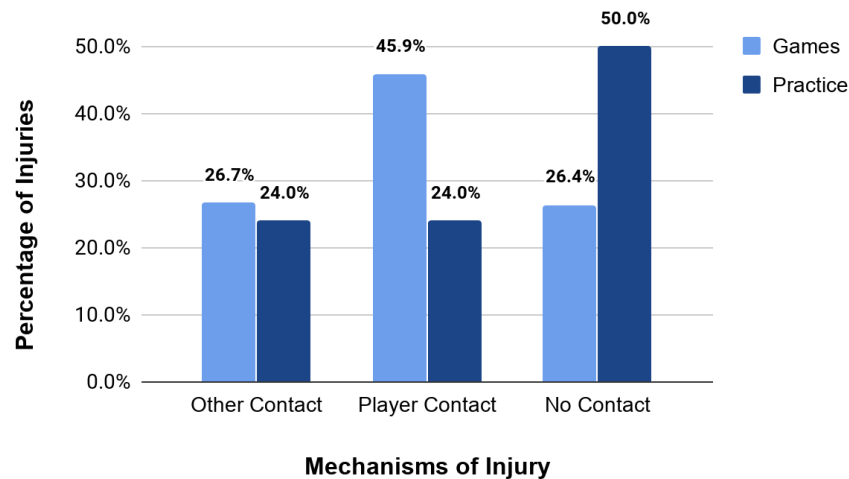

Figure 1: Injury Mechanisms in Men's Lacrosse [3].

An epidemiology study of 15 collegiate sports found that lacrosse injuries during games were 12.6 per 1000 athlete exposures (A-Es), compared to 3.2 per 1000 A-Es in practices, where an A-E, represents one athlete participating in one practice or game. To understand how this injury rate relates to other sports, view [Table 1](#). The following injury rates represent injuries to any part of the body that met the following criteria:

- “(1) injury occurred as a result of participation in organized intercollegiate practice or contest;
- (2) the injury required medical attention by a team certified athletic trainer or physician
- (3) the injury resulted in a restriction of the student-athlete's participation or performance for one or more days beyond the day of injury” [4].

Table 1: Tabulated data from Epidemiology of Collegiate Injuries for 15 Sports [4]

Sport	Injury Rate in Games	Injury Rate in Practices
Average Across All Sports	13.8 per 1000 A-Es	4.0 per 1000 A-Es
Football	35.9 per 1000 A-Es (highest)	9.6 per 1000 A-Es (highest)
Men's Ice Hockey	16.4 per 1000 A-Es	2.0 per 1000 A-Es
Men's Lacrosse	12.6 per 1000 A-Es	3.2 per 1000 A-Es
Men's Baseball	5.8 per 1000 A-Es	1.9 per 1000 A-Es (lowest)

Anatomy of Shoulder

The shoulder is a unique joint compared to other body parts because its structure allows for a wide range of motion, it is more susceptible to injuries. The shoulder is made up of ligaments, tendons, bones and muscles that connect the torso to the arm, displayed in [Figure 2](#). Ligaments hold bones together at the joints and are covered by muscles. The three bones that make up the shoulder are the clavicle (collarbone), scapula (shoulder blade), and the humerus (arm bone). Along with these bones, there are two major joints called the acromioclavicular (AC), and the glenohumeral (GH).

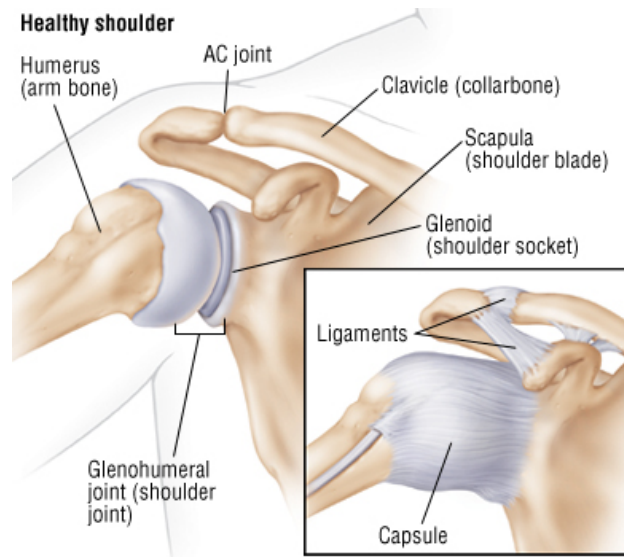

Figure 2: Bones and Joints of the Shoulder

Bones and Joints

The scapula (shoulder blade), is the most complex of the three bones that make up the shoulder. It is attached by muscles to the rib cage and also has three main points of connection with the spine, acromion, and coracoid. An additional shoulder bone is the humerus. This bone is part of the ball-and-socket; the “ball” is the head of the humerus and the “socket” is the bowl part of the scapula and glenoid, which collectively form the shoulder girdle. Lastly, the clavicle originates at the sternum and helps hold the shoulder to the side, allowing the scapula to move around [5].

The points at which the bones come together are the joints that compose the shoulder. The AC joint links the arm to the body at the chest. It sits at the top of the shoulder between the clavicle and acromion (highest point of the scapula) and allows the arm to rise above the head [5]. The GH joint allows the arm to move forward and backward, side-to-side, inward and outward, across the body, and in a circular motion. It is the ball-and-socket type, where the head of the humerus connects with the bowl part of the scapula. The GH joint is the most commonly dislocated joint in the body [5].

Muscles, Ligaments, and Tendons

Though the shoulder is made up of three bones, it is not held together by them, but rather a complex unit of muscles, ligaments and tendons [5]. Located above the shoulder joint is the deltoid muscle which is made up of three parts, the anterior, the medial and the posterior. The anterior portion originates from the clavicle bone, the middle originates from the acromion, and the posterior originates from the spinal portion of the scapula. The anterior and middle portions allow for elevation in the scapular plane as well as aid in forward motion [6].

Lacrosse Shoulder Injuries

It is important to understand the mechanism of shoulder injuries to improve protective equipment. Athletes across collision sports, including lacrosse, are taught to body check without their head and to lead with their shoulder, relocating the impact onto the shoulder. AC joint injuries are the most common lacrosse injuries followed by frequent labral injuries; there is also a high incidence of shoulder separations and other traumatic shoulder injuries such as dislocations and collar bone fractures in men’s lacrosse [7].

Despite the required protective equipment, the limited protection provided by current equipment leaves the shoulder of an athlete vulnerable to injuries by contact. A study by Yale University School of Medicine compiled all shoulder injuries that were reported to the National Collegiate Athletic Association (NCAA) Injury Surveillance System in men's lacrosse from 2004-2009. The injury type, outcome, and time lost were all analyzed. The results of this study are as follows:

“Player-to-player contact caused 57% of all shoulder injuries, and 25% were due to contact with the playing surface. The average playing time lost was 11.0 days, with 41.9% of all shoulder injuries requiring ≥ 10 days. Clavicle fractures and posterior shoulder dislocations were severe, with no athletes returning to play during the same season” [8].

Clavicle injuries are seen at every level of play and can keep players out of competition for 9-12 weeks and may require surgery [9]. Other major injuries such as rotator cuff tears, and cartilage labrum injuries, although less common, can be caused by the contact seen in lacrosse [9].

Forces of Injury In Lacrosse

As previously mentioned, AC joint and clavicle injuries are often caused by body checking. In a typical body check, one player will drive the top of their shoulder into the opposing player. The contact of the direct blow forces the shoulder girdle away from the clavicle putting stress on the ligaments in the shoulder. This same collision can also occur when a player falls and hits the ground, separating the AC joint. [Figure 3](#) shows a direct blow to the shoulder. In an analysis of impact forces in a shoulder tackle in rugby, it was found the average adult athlete produced a force of 373 lbf in a laboratory and 449 lbf on the field [10]. Another study found that the collision time was 0.5 seconds and a tackler's velocity when entering contact was 17.0 ∓ 10.5 ft/s, which was higher than the ball-carrier's velocity of 13.5 ∓ 6.07 ft/s [11]. Lastly, a biomechanical study of the mechanism of clavicle fractures found that an average compression load of 343 lbf in the x-direction is required to break a clavicle bone [12].

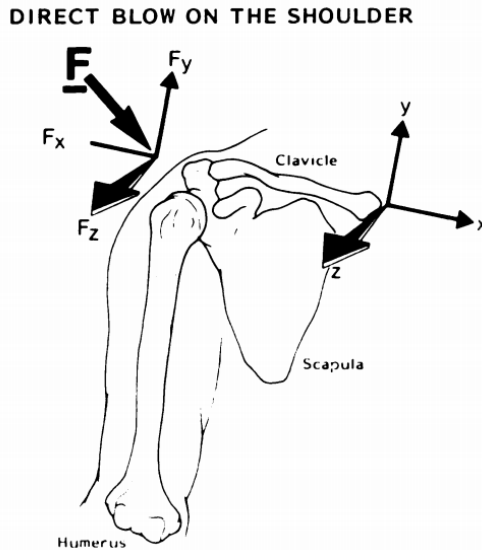

Figure 3: Impact Force Vector Representation of a Direct Blow to the Shoulder

Lacrosse Shoulder and Chest Protection

Sporting equipment as a whole aims to protect the athlete while also allowing the athlete to perform at their highest potential. With the exception of the helmet, protective lacrosse equipment has not evolved significantly over the last 30 years. Much smaller than traditional football or hockey pads, lacrosse shoulder pads are designed to be lightweight and trade less protection for increased mobility. The mobility of a player serves an important role in the success of a player to carry, pass, and shoot the ball. Most pads on the market consist of soft foam padding and some also have harder plastic pieces covering the sternum and shoulders. There are two main types of shoulder protection in lacrosse: liners and shoulder pads. The fit of liners are snug to the body and are more low profile, offering basic sternum and collar bone protection, as seen on the right of [Figure 4](#). This type (sometimes referred to as speed pads) has no outer shoulder (deltoid) or arm padding and is typically worn by players who want more mobility and can sacrifice protection, such as defenders. Liners, although lighter, offer minimal protection. Other players, such as attackmen who are checked more often, prefer more protection and therefore often wear traditional shoulder pads. These pads are usually bigger and bulkier than liners, to provide the player with extra shoulder and upper arm protection. The downside of these

pads is that increased protection often leads to less mobility [13]. Current pads can reduce the impact of general checks and hits, but overall leave the player susceptible to injury.



Figure 4: Maverik Rome RX3 Shoulder Pad (left) and Max Liner (right)

Popular Protective Pads on Market

There are various manufacturers who produce shoulder protection ranging from minimal to heavily protective. Maverik, a lacrosse equipment manufacturer, is a top competitor in the making of lacrosse pads. Two of their top products, the Rome RX3's and Max's, are designed to manage high-velocity impacts from checks, slashes, and crosschecks while maximizing mobility [14]. They also utilize a mesh inside to create a more breathable interface, as well as adjustable shoulder cuffs [13]. The addition of XRD® Technology in Maverik's equipment allows their padding to be soft to the touch and harden upon impact. XRD® Extreme Impact Protection is an open cell foam which is breathable and soft during regular use. During high-speed impacts the XRD® Material “freezes” momentarily, ultimately creating a firm shell that protects the body from the impact [15]. This material can instantly dissipate force, absorbing up to 90% of high-speed impact energy (measured to ASTM-F1614-C standard). This foam is engineered for shock absorption and can undergo repeated impacts [15]. What this pad lacks, is direct protection to the AC joint. While the newest version of the Maverik Rome shoulder pad provides additional protection to the top of the AC joint, there is nothing protecting this area from frontal impact.

What all pads have in common, regardless of their level of protection, is their placement of focus on protected areas. The main contact points that are vital to protect are the collarbone, sternum, and upper middle back (spinal) area. Current pads emphasize protection to the ribs,

sternum, shoulder (partial coverage to clavicle), and spine. General areas that are left exposed in pads are the AC joint and the majority of the clavicle.

Testing Methods for Equipment

No governing bodies of lacrosse have specifications regarding the required level of protection offered by shoulder pads. The NCAA does not directly regulate the development of technical or scientific standards of equipment or equipment testing. They do however provide “informal guidelines” on the standards of safety and performance of pads to manufacturers. The Men’s Lacrosse Rules Committee recommends, “manufacturers planning innovative changes in lacrosse equipment submit the equipment to the committee for review before production” [16]. National Operating Committee on Standards for Athletic Equipment (NOCSAE) is the provider of all standards for equipment performance in the United States (US). NOCSAE has standards to which helmets and balls used in lacrosse must be tested but has no specifications for any shoulder pads in lacrosse or even American football.

Methodology

Developing a Design

Objectives

We strived to create a lightweight shoulder pad that surpassed the level of protection offered by traditional shoulder pads while not hindering mobility. To achieve this goal, our team identified several objectives.

1. Create a shoulder pad that provides more protection than other pads on the market (especially to the acromioclavicular joint area).
2. Create a lightweight, flexible shoulder pad that doesn't hinder range of motion.
3. Create a durable shoulder pad that can undergo repeated impacts.
4. Design a shoulder pad that is manufacturable and is affordable to consumers.

Forces of Impact

To develop an optimal shoulder pad, it was important to determine the impact force of a direct blow to the shoulder. We specifically focused on direct blows to the shoulder seen in player-to-player contact because it is the leading mechanism of injury in lacrosse. [Table 2](#) represents the force of a typical open field rugby shoulder tackle, measured by having players tackle a bag configured with a force sensor [10]. The maximum force of a two-player collision was extrapolated by doubling the force of a rugby shoulder tackle, assuming the players struck each other with the same force.

Table 2: Contact Loads

Variable	Value [lbf]
Force (rugby shoulder tackle)	449
Maximum force (two-player collision)	898
Force to break a clavicle bone	343

[Figure 5](#) below illustrates a contact point that represented a collision with another player. This point represented a player being body checked by a defender. This angle and impact point

did not represent the most damaging angle of impact; however, it represented a common way a lacrosse player would be impacted.



Figure 5: Contact Load Location

[Figure 6](#) highlights the key zones, shown in red, that our shoulder pad aimed to protect. Our shoulder pad placed emphasis on protecting the clavicle and the AC joint because those are the most susceptible to injuries and it is what pads on the market fail to protect. Our pad still maintained the same level of protection for the sternum, spine and shoulder blades, that current pads do provide since these areas were not the focus of the project.

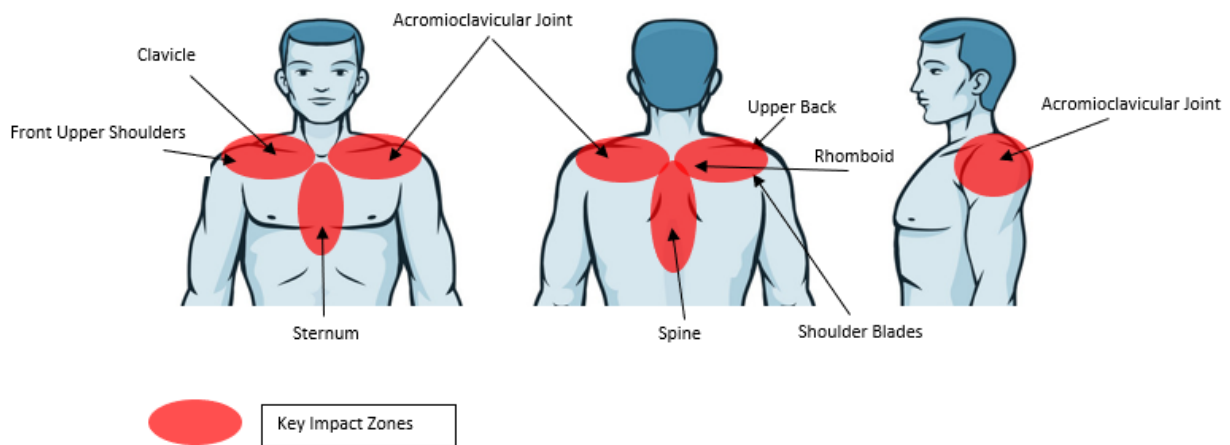

Figure 6: Key Impact Zones with Labeled Anatomy

Performance Standards

There is an absence of standards to which lacrosse shoulder equipment is tested, therefore we created our own set of standards based on the collisions seen in both lacrosse and other

contact sports, shoulder anatomy, and existing standards for other protective devices such as helmets. Our team used the specifications listed in [Table 3](#) to guide our design process.

Table 3: Design Specifications

Standards		Justification
1	Shoulder pads will be subjected to multiple impacts at the front (anterior), side (medial), back (posterior) and top of the shoulder.	Players are subjected to multiple impacts throughout the course of a game.
2	The shoulder pad will be subjected to 6 impacts at each location	Players are subjected to multiple impacts throughout the course of a game.
3	The maximum peak force produced cannot exceed a limit of 1500 lbf.	Typical forces reported of a collision with two people running at one another is 898 lbf. We feel that this is a reasonable cap because it has a built-in safety factor of 1.8.
4	A passing shoulder pad must withstand all impacts aforementioned without any damage or blemishes that render the equipment unable to perform its function.	Any damage to the pad that compromises performance/ability to protect the athlete is considered defective.
5	An impact test that does not meet the aforementioned criteria shall be declared inconclusive and must be corrected and then repeated.	If a test is performed at a force higher than experienced in a game, failure doesn't mean a piece of equipment is useless to a player in an actual situation.
Constraints		Justification
1	Rules of lacrosse	The design should not pose a danger to the user or any other players.
2	Limited research available on shoulder response due to impact in collision sports	There are no defined tests on impact testing in lacrosse, so rugby studies were used in order to gauge values since the impacts are similar.

Preliminary Design

Based on the risks of the sport, the anatomy of the shoulder, common shoulder injuries, and the development process of sporting equipment, our team developed a set of weighted design criteria (see [Table 4](#)). A current shoulder pad on the market served as a baseline to which our

conceptual designs were weighed against. [Figure 7](#) displays a sample of the team’s initial design ideas.

Table 4: Design Matrix

Criteria	Weight	Description
Protective	1.00	Provides ample protection to the acromioclavicular joint area without sacrificing other areas.
Mobility	0.90	A lightweight, flexible device that doesn’t hinder range of motion.
Durability	0.80	Create a durable piece of equipment that can undergo repeated impacts.
Manufacturability	0.65	Capability to be easily made in an existing facility, with common techniques.
Comfort	0.65	Needs to be ergonomic, should not cause any discomfort.
Weight	0.50	Needs to be insignificant for the player and does not hinder performance.
Cost	0.40	Affordable to consumers ranging between \$80 - \$150.
Maintainability	0.25	Ability to clean as needed.
Simplicity	0.25	Easy for an athlete to put on and take off.
Weatherproof	0.25	Does not deteriorate or decrease performance in adverse conditions.

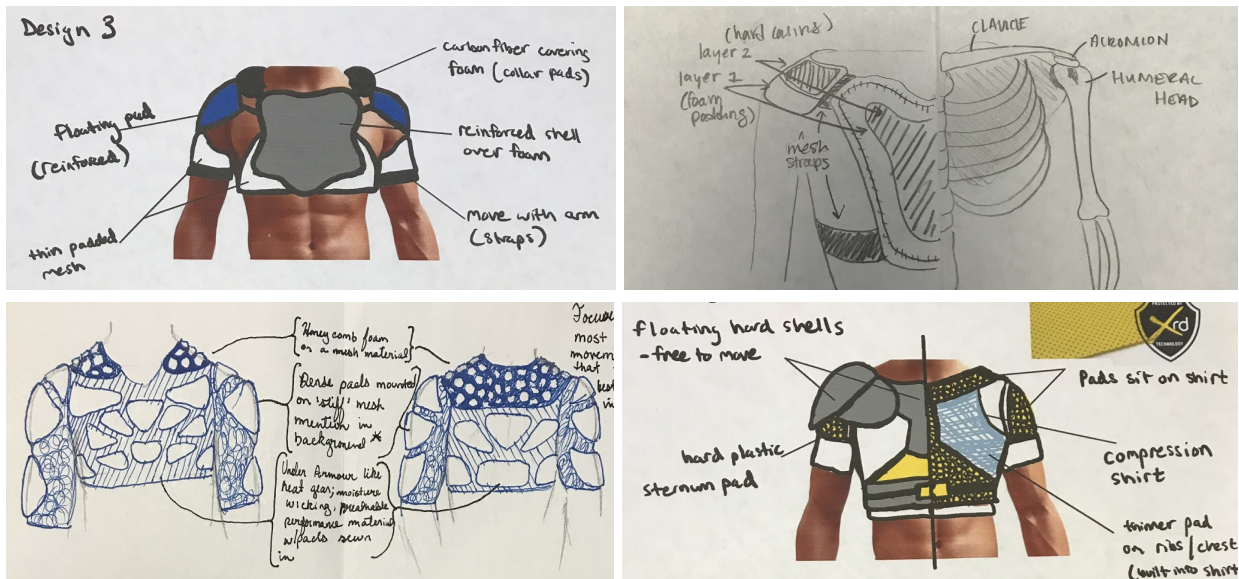

Figure 7: Sample Brainstorm Designs

Each of these designs had at least one notable feature. The top left image in [Figure 7](#) displays a design with plastic shoulder caps that covered the entirety of the shoulder, allowing for maximum protection. The top right design contained mesh straps to allow the shoulder cap to move with the athlete's shoulder, while also was attached to a harder and stiffer chest plate. The bottom left image used honeycomb shaped foam throughout the shoulder cap which allowed for mobility. Lastly, the bottom right image contained a two-layer system which was the foundation for our preliminary design. We combined aspects from our initial brainstorming designs into our preliminary design shown in [Figure 8](#).



Figure 8: Sketch of Preliminary Design

This preliminary design consisted of a three-layer system: (1) a compression layer; (2) two protective layers of foam and (3) hard plastic. The compression layer kept the athlete's muscles under pressure, promoting blood flow and providing extra support to underlying tissue. This first layer was breathable and moisture-wicking, allowing for a full range of movement and would keep the foam snug to the athlete. The foam layer would provide protection by way of energy absorption and dissipation while also being lightweight and comfortable. The plastic layer would provide additional protection to the shoulder, chest, and back. This design would offer the most protection without compromising mobility or the weight of the pad.

Final Design

As mentioned, the most common and most severe shoulder injuries in lacrosse are to the AC joint and clavicle, respectively, and are caused primarily by contact with another player. For this reason, the emphasis was placed on these areas. Most pads on the market include protection

to the clavicle but tend to lack sufficient protection to the AC joint. [Figure 9](#) displays the three layers of our final design; compression, foam and hard plastic. The black straps represent the elastic material that would hold the shoulder caps snug to the athlete, allowing him to move freely while the caps moved with him.

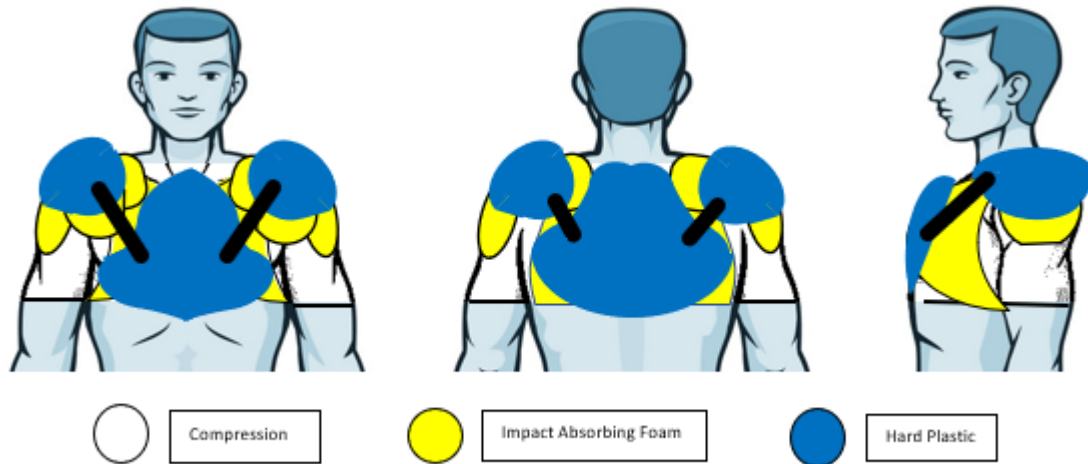

Figure 9: Layer Placement for Final Design

Placement of Protection

Dimensions of an average male lacrosse players' upper body, specifically measurements of the shoulder, were not available in research. We used a male team member, who was a collegiate lacrosse player of average height and weight, for all measurements. In [Figure 10](#), the vulnerable body parts: the clavicle, spine, sternum, scapula, and humeral head are outlined in blue, flexure points are outlined in red, coverage offered by a standard lacrosse liner is outlined in green, and the preliminary configuration for the foam is outlined in black. Note that an additional "floating pad" (not seen in [Figure 10](#)) would be used to provide protection to the flexure point (in red) located at the AC joint. The shape of the foam in black does not represent the final shapes or sizes, but rather illustrated a general region to which the foams shall protect.

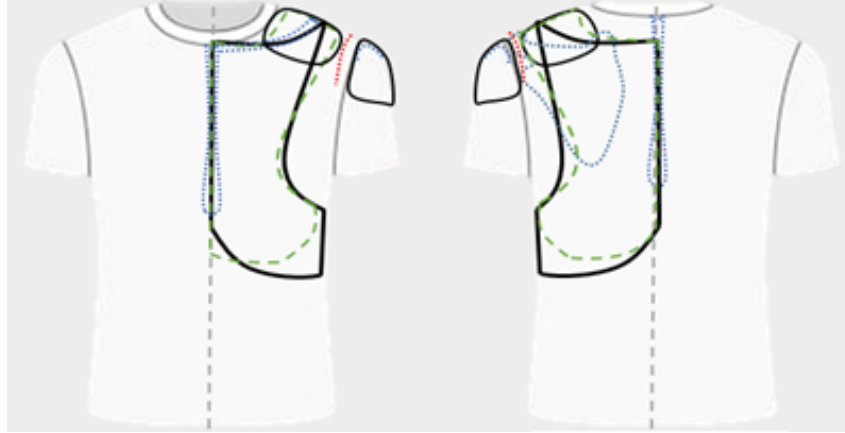

Figure 10: Dimensions & Configurations (Left-Front View, Right-Back View)

Material Choice

[Figure 11](#) offers a visual of the three layers from top to bottom. The first layer, consisting of a compression shirt made of a polyester-spandex blend, holds the foam in place and snug to the player. The second layer (first layer of protection) is comprised of XRD® foam. The third layer (second layer of protection) is a hard carbon fiber composite shell.



Figure 11: Layers of Shoulder Pad Design

The primary layer of protection was the XRD® Protection foam. Both EVA and HDPE foams were considered because they are typically used for sports padding. When the air inside the closed cells is compressed, such as upon impact, some impact energy is absorbed and then the decompression of the air provides the return or cushioning force. The limitations of these closed cell foams are when the walls break during compression. These foams also behave the same at every strain rate and are typically stiffer and less comfortable. When researching foams with high shock absorption properties, we came across XRD® Extreme Impact Protection and D30®. Both of these materials offer impact protection solutions. We chose XRD® Material since it is soft and comfortable and only hardens upon impact. This property was perfect for what we needed in our design and XRD® Material has had success in other products. Samples of this

material were also made available to us, allowing for prototyping. The shear thickening (dilatant) behavior of this material allows for the particles to jam up when exposed to high shear strain rates (viscosity increases steeply). The XRD® Technology foam reacts well to high-speed impacts, dissipating impact forces and absorbing up to 90% of energy. When the soft and flexible smart-foam is impacted quickly, the glass transition temperature drops, and the material stiffens. This foam absorbs little water (10% weight gain based on ASTM D 570 - 2-hour water immersion at room temperature). This open-cell foam is also engineered with breathable open-cell technology and antimicrobial protection to help prevent bacteria growth. [Table 5](#) presents a breakdown of high-impact grades of XRD® Material. It is important to note that it does not present every option. The ID number correlates to the foams' density (first two digits) and thickness (last three digits). For example, ID 15500 represents a foam with a density of 15 lb/ft³ and a thickness of 0.500 inches [17].

Table 5: XRD® Material Breakdown

ID #	Density (lb/ft³)	Thickness (in)	Description
15500	15	0.500	Highest energy absorption, thickest, most protective
15374	15	0.374	Highest energy absorption and thinnest
12500	12	0.500	Second least dense and thickest
09500	9	0.500	Least dense and thickest

For what we aimed to achieve through our design, which was to maximize protection and mobility, the XRD® Material that had a density of 15 lb/ft³ and a thickness of 0.374 in was deemed most appropriate. It contains the highest density within the high-impact category and the higher the density foam results in more energy absorption per unit volume. This choice was also the thinnest option of the high-impact foams, offering the potential for increased mobility.







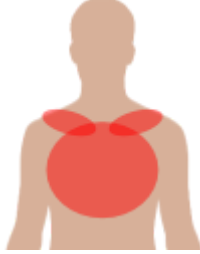
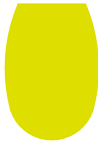

The third layer consisted of a thin (0.125 in) carbon fiber reinforced plastic. Carbon fiber has a high strength to weight ratio allowing us to achieve a layer of rigidity without adding unnecessary weight or bulk. We decided to incorporate a carbon fiber reinforced thermoplastic. This composite material is called Stylight® and consists of carbon fiber and a modified styrene acrylonitrile resin (SAN), which is a copolymer between styrene and acrylonitrile [18]. The technology for making parts of this material involves thermoforming. This material would allow

us to make a thin and flexible component that was strong and also remained lightweight (density of 1750 kg/m³). This material has very low moisture absorption (0.08% according to ISO 62) and can survive weathering effects such as rain, sweat, and sun exposure. We also explored using Kevlar fibers in a composite due to its high strength to weight ratio and great fracture toughness. We ultimately chose carbon fiber as reinforcement due to the higher stiffness. The points of impact where these components would be placed cover direct bone and we wanted a strong, light and stiff material. While Kevlar is less brittle than carbon fiber, we believed that the stiffness and strength of these components were more important and would be more effective if made with a carbon fiber composite. Also, since these would be composites, with the fibers as reinforcements, the matrix material was more important in terms of cracking upon impact [18].

Design Components







The foams, the hard plastic shell plates and caps were all modeled using SolidWorks. [Table 6](#) shows the configuration of the XRD® Foam 15374 (Density: 15 lb/ft³, Thickness: 0.374 in) for the second layer. These foams were modeled flat because the XRD® Material was available to us only in flat sheets. Though one component is shown for foams B, D, and E there was a quantity of two per component. In total, there were eight foam pieces that made up the second layer.

Table 6: Foam Configurations

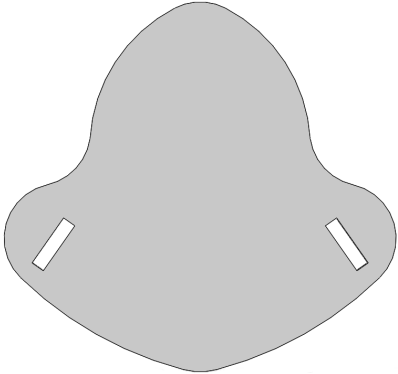
Location on Body	Notation	Configuration	Foam Coverage	
Front	A		Clavicle, Upper Ribs, Sternum	
	B		Front Torso	
Back	C		Scapula, Spine, Back-Side Ribs	
Top	D		AC Joint, Clavicle, Shoulder Blade	
Side	E		Humeral Head	

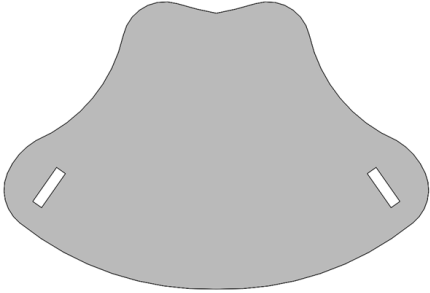
The shape of the hard protective layer is presented in [Table 7](#). Each shell component shared the same thickness of 0.125 in and featured two rectangular holes (0.25 in x 1.0 in) for straps. The rectangular holes were the location to which the shoulder cap (H) would attach to the F & G plates.

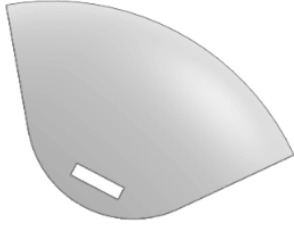
Table 7: Hard Plastic Shell Configurations

Location on Body	Notation	Configuration	Shell Coverage	
Front	F		Sternum	
Back	G		Spine	
Top	H		AC Joint, Clavicle, Humeral Head	

[Figure 12](#) and [Figure 13](#) demonstrate the combined arrangement of the XRD® Material (foams A, B, C) and the hard carbon fiber composite shell (plates F and G) for the upper body protection, excluding the shoulder cap. The floating pad (B) provided additional coverage to the front torso, an area that which current pads on the market typically leave exposed.

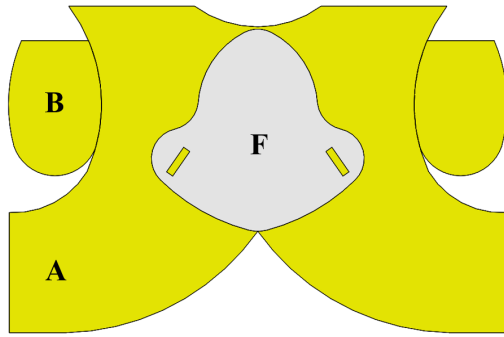

Figure 12: Front Protection: Layers 2 & 3

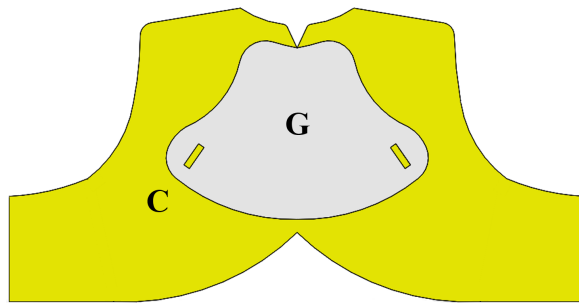

Figure 13: Back Protection: Layers 2 & 3

[Figure 14](#) demonstrates an exploded view of where foams D and E would be placed along with the hard carbon fiber composite cap (H). Though not as good of representation in respect to how the foams would look molded to a body, the figure offers a better insight into the layering and configuration of the shoulder cap and foams. The dimensions of these layers can be found in [Appendix A](#).

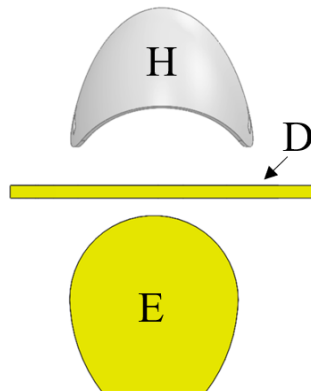

Figure 14: Shoulder Protection Side View: Layers 2 & 3

Developing a Testing Method

Due to the limited rules and regulations set by the governing bodies of lacrosse, there is no existing test for lacrosse shoulder pads. Furthermore, there was little information with regards to tests specifically relating to the shoulder, therefore we adapted testing procedures from other impact sports and modified testing these methods for this project. Generally, football helmets are tested in a number of different ways, the most popular being a pendulum impact test and a drop test. A pendulum test is where a suspended mass with a swinging motion delivers a force to the device being tested. This test was feasible to replicate and offered consistency and accuracy when performing the physical test and measuring results. We considered a drop test however we wanted to test a horizontal impact rather than a vertical impact. Additionally, the drop test does not allow for precision with different impact angles.

Modeling Testing Rig

Collisions involve a transfer of energy and/or a transformation to a different form of energy; the kinetic energy of one player is transferred to another as contact is made. To offer the most protective pad possible, the pad would have to absorb and dissipate as much energy as possible. Consideration of the principle of conservation of energy, specifically the transfer of energy, is important in order to understand where the energy goes as it moves through the system. [Table 8](#) displays the general equations used to further our understanding of the testing method.

Table 8: General Equations

Equation		Nomenclature	Assumptions
Eq. 1	$\Delta E = \Delta KE + \Delta PE + \Delta U$	ΔE = change in energy ΔKE = kinetic energy (ft·lbf) ΔPE = potential energy (ft·lbf) ΔU = internal energy (ft·lbf)	-Energy is conserved throughout the system.
Eq. 2	$F=ma$	F = Force (lbf) m = mass (slugs) a = acceleration (ft/s ²) and $F = m \cdot \frac{dv}{dt}$ where, v = velocity (ft/s)	-The mass of the pendulum acts on a point. -Acceleration is constant. -There is no friction or drag acting on the pendulum. - Mass of pendulum is constant

As previously stated, XRD® Extreme Impact Protection is high strain rate sensitive foam that “freezes” momentarily during high-speed impacts, ultimately creating a firm shell that protects the body from the impact [15]. Due to the behavior and relationship between the stress and strain rate of the foams, it was difficult to model.

Several attempts were made to effectively model the energy absorption of the foam, such as force plate tests, Solidworks, and MATLAB. We also reached out to Rogers directly to inquire if they had any current models, however, they had been unsuccessful in modeling their own foam. Properties of the unique non-newtonian foam was unpublished, and therefore made theoretical modeling unfeasible. The most effective way to ensure that the pad would be effective was to simulate a real collision during testing. During a collision in lacrosse, there are several parameters that need to be considered: the duration of the collision, the force of impact, the point of impact, the direction of impact, the temperature, and even the humidity. The comparisons to rugby tackles allowed us to assume that the typical collision time in lacrosse is 0.5 seconds [19]. Through consideration of the parameters of a lacrosse hit and the variables we were able to control, using a pendulum test became a justifiable test to explore how our prototype would react in real life scenarios.

Relevancy

We designed and built a testing rig to test the effectiveness of shoulder pads. We partnered with another Major Qualifying Project (MQP) team for this design. We designed the shoulder system of the dummy to approximately emulate the dimensions of a shoulder. It was out of the scope of this project to create a model that simulated true shoulder response because the purpose of our project was to determine the effectiveness of our pad at reducing impact force, not on assessing how an impact affects the shoulder. Shoulders are very complex and vary from person to person. However, our team replicated the joints of the shoulder rather than using a single, solid body. Two torsion springs were incorporated to give the system the absorption response similar to a real shoulder, but do not represent the response of a true shoulder. The dummy was constructed primarily from A36 steel to represent bones, layered with a neoprene rubber sheet with a shore hardness of 30A to represent muscles. Steel is much stronger than bone, but since we tested with forces high enough to fracture a bone, we needed to construct the

rig of a material able to withstand repeated impacts at a high magnitude. All components of the rig were constructed using the same A36 steel except the torsional springs (spring steel) and the rubber strips (neoprene). A36 steel is also very weldable and could be machined with the MiniMills we had available to us. The distribution of weight for the dummy was measured to ensure that the center of mass was similar to an actual torso, with bars attached to the dummy for additional weights to be added. The upper body of an average male makes up ~55% of their total weight. Our dummy shares dimensions to that of a 185 lb male. Since the thorax and abdomen of the dummy needed to be open and accessible for the other MQP team, there were bars added to the side of the dummy to add additional weight to make up for the thorax and abdomen area (33% of total body). Without any added weights, the dummy weighed 17.4 lb (not including the head or base). The center of mass of the entire torso is midway through the thorax where the bars for added weight were attached. To simulate an actual 185 lb male, we added the remaining weight to add up to 102 lb including the head (55% of total weight).

The testing rig (see [Figure 15](#)) consisted of the dummy which sits on a sliding base (see [Figure 16](#) and [Table 9](#)) and the pendulum. Two uprights held the pendulum which was able to swing from two different heights. The base could be moved to center the impact area on the pendulum's path. The dummy was capable of being rotated and tilted to allow for any part of the shoulder to be impacted directly. The pendulum was capable of being dropped from any angle with variable weight to adjust the force of impact. When the pendulum struck the dummy, the force was transferred to the dummy which then slid along the track.

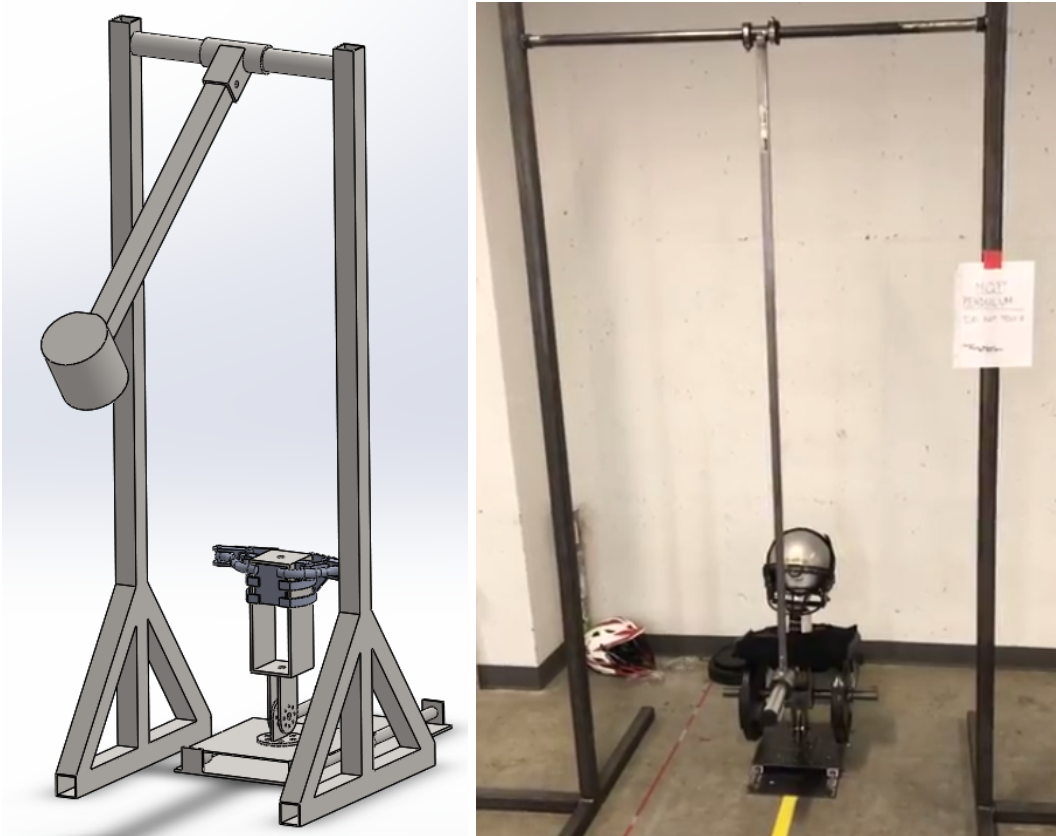
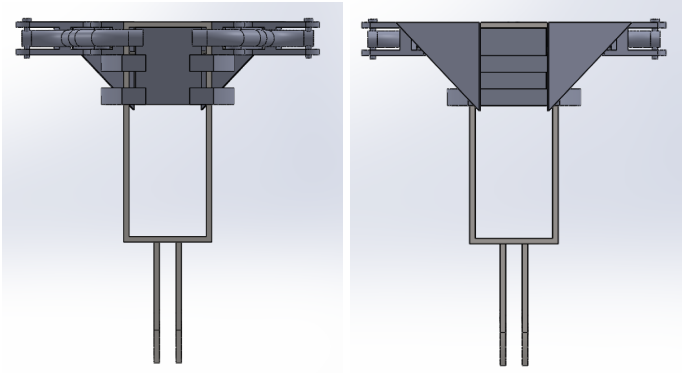
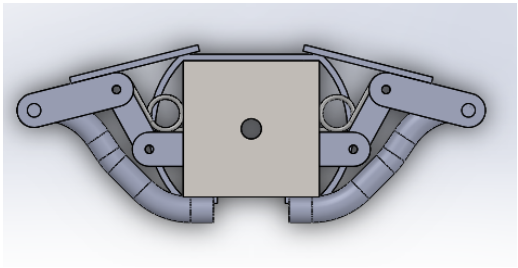
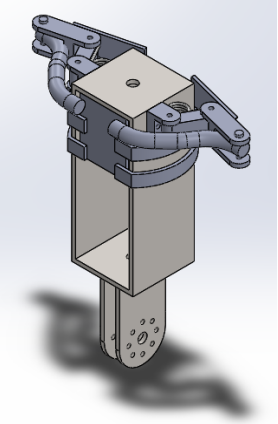

Figure 15: Testing Rig and Dummy Demonstration



Figure 16: Assembled Dummy

Table 9: Test Dummy Design

<p>Front View (Left) Back View (Right)</p>	
<p>Top View</p>	
<p>Isometric View</p>	

Through a pendulum test, we were able to compare our pad's performance against two current lacrosse pads. To assess the pad's performance, we used an accelerometer, which allowed us to quantify the reduction of impact force of each pad. This device measures the g-force (acceleration relative to gravity). While the g-force is not a fundamental force, it is often used to describe the severity of an impact since it can be measured with an accelerometer. An object in free fall will experience a g-force of 1 g, or 9.81 m/s^2 , on earth's surface, whereas an object

subjected to a g-force of 10 g would describe an acceleration that is 10 times the acceleration due to gravity.

By measuring the g-force that the test dummy experiences, we can relate the severity of simulated player-to-player contact and the performance of different lacrosse pads. For our pendulum test, we measured the g-force resulting from a low (431.3 lbf), medium (594.9 lbf), and high (867.7 lbf) impact on the dummy wearing no pad, our prototype, and two other pads currently on the market. We were able to compare the performance of each pad in reducing the g-force experienced by the dummy.

Applied Calculations

The purpose of the following calculations was to determine the force exerted by the pendulum with different weights added to the end of the pendulum (bob). [Table 10](#) shows the calculations that determined the force the pendulum (the bar and bob) applied to the dummy. The mass of the bob, which varied according to the weights added, was calculated to determine the magnitude of forces applied during testing. Below is the derivation used in [Table 10](#),

$$\begin{aligned} F[\text{lbf}] &= 4.45 \cdot F[\text{N}] \\ &= (I \cdot \alpha / r_{\text{com}}) \cdot 4.45 \end{aligned}$$

$$\begin{aligned} \text{Where, } I &= (m_{\text{bar}} + m_{\text{bob}}) \cdot r_{\text{com}}^2 \\ \alpha &= (g/r_{\text{com}}) \cdot \sin(\theta_{\text{drop angle}}) \end{aligned}$$

$$\text{And, } r_{\text{com}} = ((1/2) \cdot L_{\text{bar}} \cdot m_{\text{bar}}) + ((D_{\text{bob}} \cdot 1/2) + L_{\text{bar}}) \cdot m_{\text{bob}} / (m_{\text{bar}} + m_{\text{bob}})$$

$$\text{So } F[\text{N}] = ((m_{\text{bar}} + m_{\text{bob}}) \cdot r_{\text{com}}^2 \cdot (g/r_{\text{com}}) \cdot \sin(\theta_{\text{drop angle}})) / r_{\text{com}}$$

It was necessary to determine the force generated by our pendulum where the simple pendulum, which consists of a bar and a bob, generates a point force [20, 21]. In order to evaluate our pendulum we had to make several assumptions; we neglected friction force as it was held constant throughout, we did not neglect the weight of our bar, and we assumed gravity at sea level. To not neglect the weight of our bar, we had to determine the radius of the center of mass (r_{com}) and use that as where our point force would be acting from. The radius of the center of mass varied according to the weight added. The weights that were added were 17.5 lb, 25 lb, and 37.5 lb in addition to the weight of the pendulum, 10.1 lb. These were used because they resulted in the forces seen in [Table 11](#). We used a drop angle of 30° because it was easier for us to run the

tests and mitigate any erroneous vibrations or swinging in directions other than intended. These calculations allowed us to understand the forces applied to our pad.

Table 10: Applied Calculations

Nomenclature	Unit	Calculations
Length of the bar (L_{bar})	[m]	$I = (m_{\text{bar}} + m_{\text{bob}}) \cdot r_{\text{com}}^2$ $= (2.268 + [17.5, 25, 37.5]) \cdot r_{\text{com}}^2$
Mass of bar (m_{bar})	[kg]	
Diameter of bob (d_{bob})	[m]	$\alpha = (g/r_{\text{com}}) \cdot \sin(\theta_{\text{drop angle}})$ $= (32.2/r_{\text{com}}) \sin(30)$
Mass of bob (m_{bob})	[m]	
Drop angle ($\theta_{\text{drop angle}}$)	[deg]	$F[\text{N}] = [I \cdot \alpha / r_{\text{com}}]$ $F[\text{lbf}] = F[\text{N}] \cdot 4.4482$ $= [431.3, 594.9, 867.7]$
Gravity (g)	[m/s ²]	
Force applied (F)	[N]	
Velocity (v)	[m/s]	
Radius of center of mass (r_{com})	[m]	
Angular acceleration (α)	[rad/s ²]	
Instantaneous center of rotation (I)	[m ⁴]	

We created an experimental matrix, shown in [Table 11](#), and tested each pad using the three forces generated in [Table 10](#).

Table 11: Experimental Matrix

Force Applied [lbf]	Description
431.3	Low Impact: Used to evaluate the effects of an impact below the average force of a rugby tackle (449 lbf).
594.9	Medium Impact: Used to evaluate the effects of an impact between the force of an average rugby tackle (449 lbf) and a two-player collision (898 lbf).
867.7	High Impact: Used to evaluate the effects of an impact relatively close to a two-player collision (898 lbf).

Prototype

We created a prototype of our shoulder pad design (see [Figure 17](#)) in order to evaluate our conceptual design. Due to ease and cost, instead of a carbon fiber composite, we used ABS polymer for our prototype. ABS is a terpolymer (polymer consisting of three different polymers) combining acrylonitrile, butadiene and styrene. This material combines the strength and rigidity of the acrylonitrile and styrene polymers with the toughness of polybutadiene rubber, ABS plastic is relatively effective for sustaining impact. While this material is different from our final design, this filament was readily available for use. The use of the ABS plus filament (IZOD Impact, notched @ 73°F (23° C) of 2.0 ft-lb/in) served as a proof of concept for the second protective layer as we were investigating the effect of a harder shell over the foam and how it affects mobility as well as performs in reducing the impact force.



Figure 17: Prototype Design

The process of building the prototype was done in three stages. The first stage involved cutting the XRD® Foam using a band saw and then sewing the pieces into the polyester-spandex material. In the second stage, the plastic plates and shoulder caps were 3D printed. The final stage involved attaching the plates and caps to the foam which was done using Velcro adhesives. It is important to note the positioning of the foam material (layer 2). Though the caps are two different colors, they were simply printed in two different colors of ABS filament. Foam D, that provides protection to the top of the shoulder, was oriented such that it overlapped foams A and C, which offered protection to the front and back. This overlap served as double the protection to the clavicle, a region where current pads provide little to no protection.

Testing

Impact testing served as a means to evaluate if our goal and design criteria for our final design were met. With the objective to create a lacrosse shoulder pad that effectively reduces the impacts, a player is subjected to during play, a pendulum impact test was conducted. In addition to a baseline test with no pad, three pads were tested, two of existing pads on the market and one being our prototype. After performing these tests, we reviewed the performance of each pad and evaluated the differences in impact reduction.

We performed a series of tests, recording accelerometer data at a rate of 50 Hz. We were able to observe the three-dimensional g-force change with each collision. The accelerometer was oriented on the test dummy (see [Figure 18](#)) such that the +x-axis (vertical plane) was downwards, the +y-axis (horizontal plane) was to the left, and the +z-axis goes into the page.

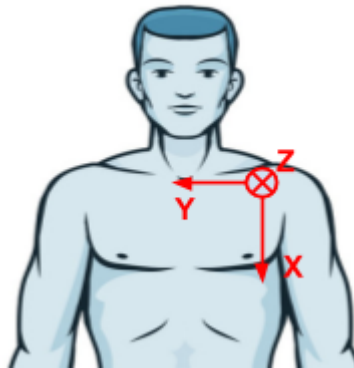

Figure 18: Accelerometer Orientation

Pads Tested

The objective of this project was to create a lightweight shoulder pad that surpassed the level of protection offered by current shoulder pads while not impeding the mobility of the player. As mentioned previously, we tested two popular full lacrosse pads (the Maverik Rome incorporates XRD® Extreme Impact Protection, and the STX Cell IV is constructed with GeoFlex II™ Technology) and compared their performances against our own pad.

Performance aside, when comparing the two current pads to our own prototype, we observed discrepancies between the pads and their coverage. A comparison of the coverage of the current pads with our prototype is shown in [Table 12](#), in which we identify the regions to

which the Maverik Rome and STX Cell IV pads leave a player exposed without protection, indicated by the red.

Table 12: Three Pads Tested

Maverik Rome	STX Cell IV	Our Pad
		
		
		

Pendulum Rig Setup

The following details the process of setting up the testing rig and how we conducted each trial. This process was repeated with the three different forces seen in [Table 11](#), six times for each pad.

1. Each member read and followed the safety procedure ([Appendix B](#)).
2. Ensured that the dummy had its correct weight distribution.
3. Secured the test equipment (shoulder pads) on the dummy.

4. Placed the dummy in the correct position for testing.
 - a. Aligned the dummy so the front of the left shoulder was perpendicular to the pendulum head.
 - b. Brought the dummy to the front position on the slider, closest to the pendulum.
5. Added the proper weight to the pendulum according to the force being tested.
6. Set up the accelerometer.
 - a. Placed the accelerometer on the dummy in line with the point of impact.
 - b. Ran the program to start gathering data.
7. Activated the Slow Motion Camera.
 - a. Positioned perpendicular to the dummy to record motion in the z-direction.
8. Two team members ensured the pendulum was in the correct position. The third member held the pendulum at a 30-degree angle to be dropped and then released the pendulum.
 - a. One team member made sure the pendulum was in line with the drop path. A yellow line was placed on the floor to indicate the path.
 - b. A second team member was perpendicular to the drop path to make sure the pendulum was being held correctly at the 30-degree angle.
 - c. A third team member held the pendulum and listened to the other team members to ensure the test was properly executed.
9. All team members waited until the dummy and pendulum had reached a resting point before entering the testing zone.

Lacrosse Team Survey

In consideration of the design matrix ([Table 4](#)) that served as a guideline to evaluate our design against, the pendulum test allowed us to assess the performance of the three pads in respect to protective capabilities. However, to address other design criteria, specifically comfort, mobility, and simplicity, we conducted a survey. This survey targeted current collegiate male lacrosse players who would understand the function of lacrosse shoulder pads. A total of 15 members participated and were asked to read and sign the *Informed Consent Agreement for Participation in a Research Study* shown in [Appendix C](#) prior to beginning the study. The

following lists the steps to which we instructed and measured the participants' capabilities when wearing each pad.

1. A team member measured the participant's range of motion for typical lacrosse movements without a pad on.
 - a. The participant was asked to keep their arm by their side and then to do a motion of raising their arm.
 - b. The participant was then asked to start with their arm across their body, parallel to the floor, and open up their arm to their side.
2. The participant was given time to evaluate the pad before putting it on.
 - a. The participant was timed when putting on the pad.
3. The range of motion test was repeated while the participant was wearing the pad.
4. The participant was timed to see how long it took to take the pad off.
5. Steps 2 through 4 were repeated for each pad.
6. The participant was asked to complete a survey of their experience ([Appendix D](#)).

Results and Analysis

Pendulum Test

We performed a series of tests recording accelerometer data at a rate of 50 Hz. We were able to observe the three-dimensional g-force change with each collision. As previously shown, [Figure 18](#) illustrates the orientation of the accelerometer. As the pendulum struck the shoulder of the test dummy, a visible vibration occurred as the dummy absorbed the impact. It then began to slide back on the track. [Figure 19](#) is a sequential photo series of (1) the dummy before impact, (2) the initial point of contact, (3) the initial vibration, (4) the rebound, (5) the slide back.

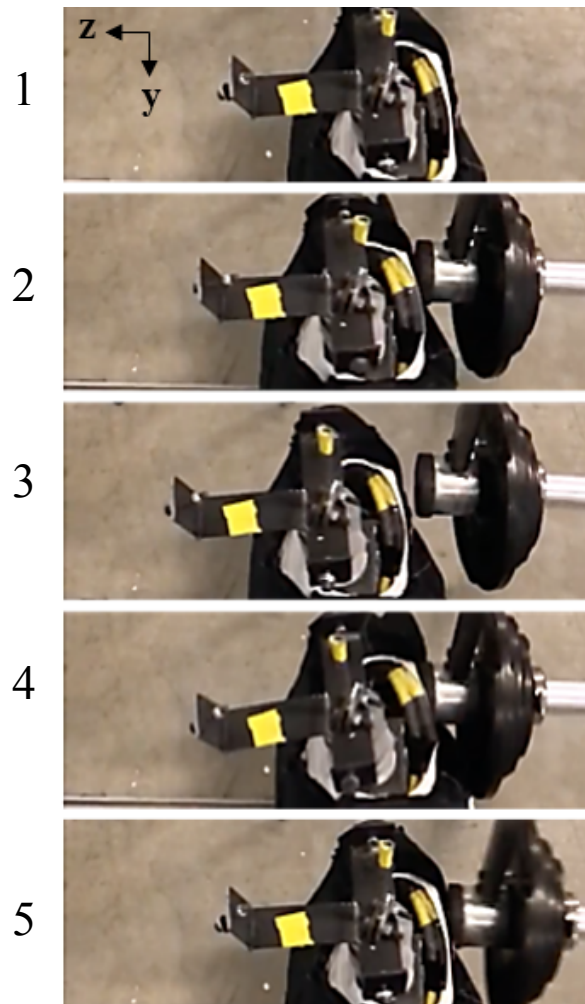

Figure 19: Sequential Shots of Contact

In the third image, the dummy is the furthest distance from the xy-plane during the dummy rocking. If there was a sixth and seventh picture, the dummy would be moving down the slider in the +z-direction.

The accelerometer recorded the instance before, during, and when the dummy came to rest. We filtered the data to find the maximum g-force magnitude. Due to the design of the testing rig, there was an issue with our data. [Figure 20](#) illustrates where we believe each sequence of the photo shown in [Figure 19](#) correlates with the data recorded on the accelerometer. The initial impact, photo 2, should have been shown in the +z-direction, but the first recorded data was in the -z-direction. This was caused by the dummy rocking forward after the initial collision at a higher acceleration than the initial impact caused. We realized that without seeing the initial strike on the dummy, it was not possible to precisely analyze our data and mitigate the effect of the vibration on our results.

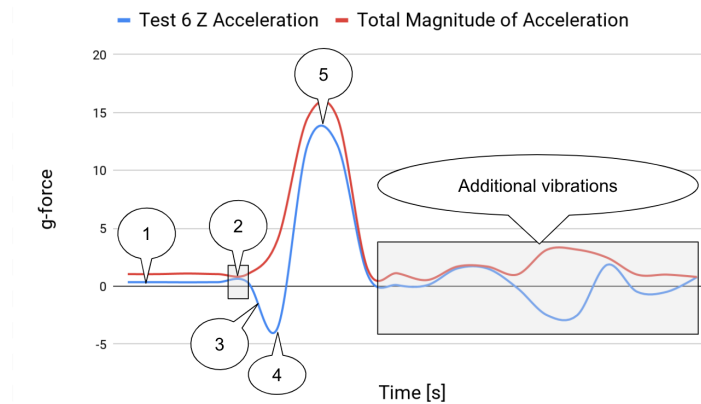

Figure 20: Acceleration Experienced by the Dummy During Impact

Since a rugby tackle lasts 0.5 s, we anticipated that the accelerometer, recording data points every 0.02 s, would be able to record the initial impact. However, using the Hertz Impact Theory equation,

$$\tau = 6.46 \cdot \rho^{(2/5)} \cdot (1/2 \cdot D_{\text{bob}}) \cdot ((2 \cdot g \cdot r_{\text{COM}})^{1/2})^{-1/5} \cdot E^{-2/5}$$

we calculated the total collision time (τ) of the pendulum and the dummy to be $9.78 \cdot 10^{-4}$ s. The collision time in a steel-to-steel impact was much faster than a player-to-player impact (partially inelastic collision). We used the footage from the video camera to analyze the pendulum-to-dummy impact during testing. After analyzing each video, we realized that during

the initial impact, the dummy lifted up causing a moment and force to be transferred in directions outside of strictly the +z-axis. The discrepancy between the time of impact and our data acquisition rate limited us to only view the way the dummy moved after the impact occurred. Due to the limited accuracy of our testing results, we began to filter our data in order to find trends of the results we did get. We decided to examine the trends in the data when the acceleration in the z-direction was at its maximums and minimums. The data correlates to the fourth and fifth image of [Figure 19](#), where the fourth image is when the minimum acceleration of each individual test occurred, and the fifth represents when the maximum acceleration occurred. We did this because we were primarily focused on the direction of impact and how it affected the shoulder. We first looked at the low impact testing results to see if we could find any trends. [Figure 21](#) shows the z-acceleration results of the baseline and each pad with a force of 431.3 lbf. Figures [22](#) and [23](#) compare the total magnitude when the z-acceleration is at its maximum and minimum respectively.

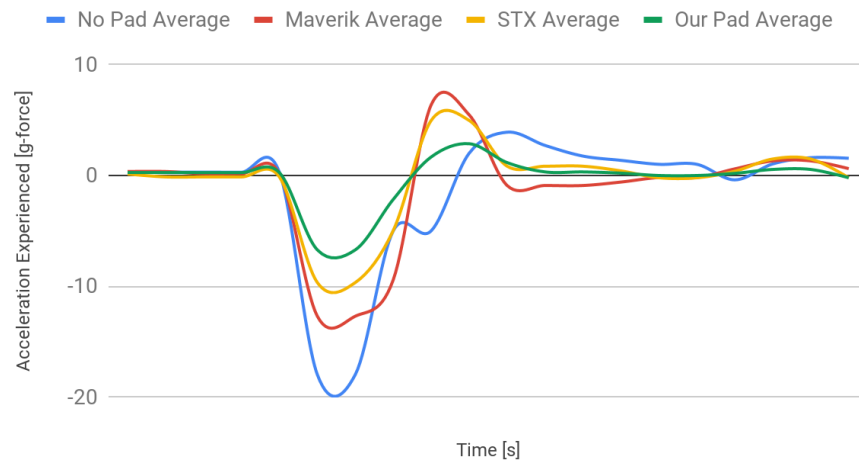

Figure 21: Average Z-Acceleration During Low Impact

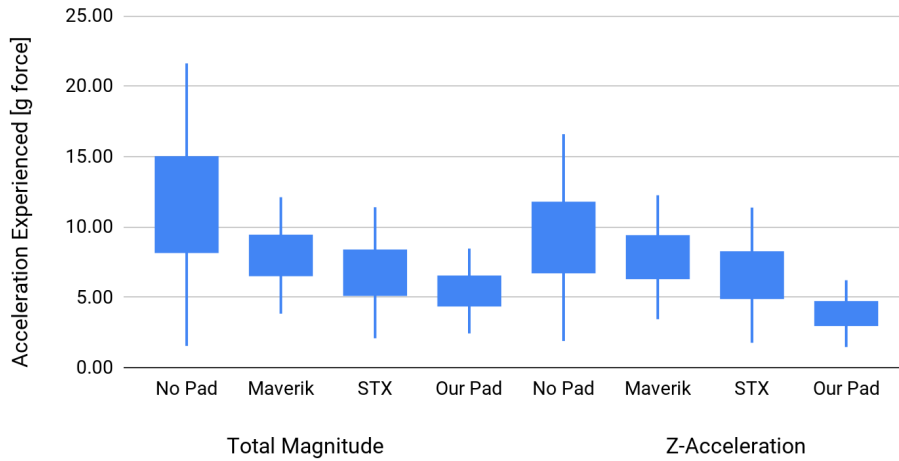

Figure 22: Low Impact Testing Data Trends at Z-Acceleration Maximum

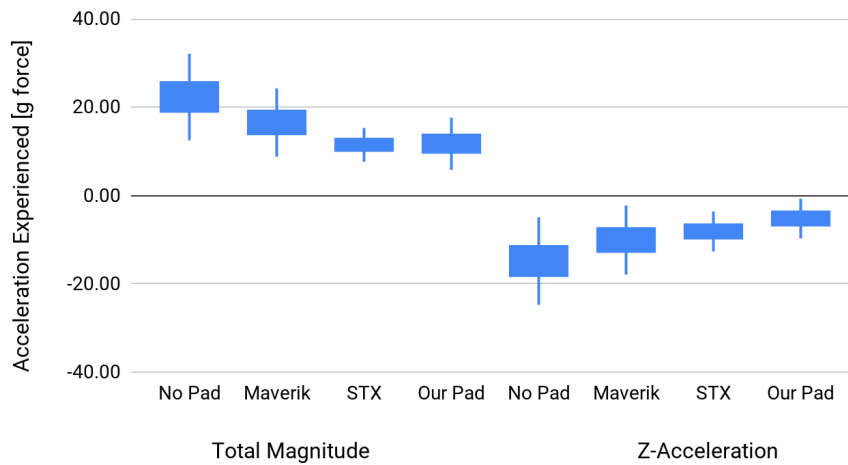

Figure 23: Low Impact Testing Data Trends at Z-Acceleration Minimum

These data trends suggest that for the low impact our pad performed better than both the STX and Maverik pad, specifically when viewing the total magnitude was at both the minimum and maximum values of z-acceleration. [Figure 21](#) illustrates how each pad performed throughout the entire low impact test, it suggests that in low impact situations the STX and our pad performed similarly while the Maverik was lagging in terms of energy absorbed by the pad. We then looked at the medium impact results (594.9 lbf). [Figure 24](#) shows the results of the baseline and the three pads. [Figures 25](#) and [26](#) compare the total magnitude when the z-acceleration is at its maximum and minimum respectively.

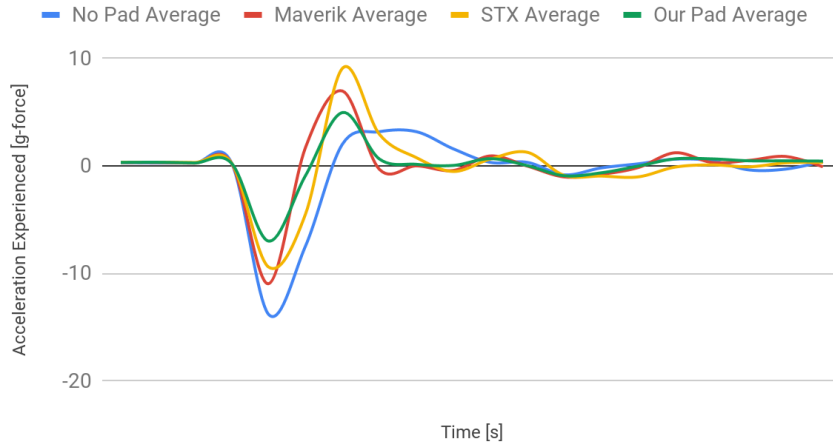

Figure 24: Average Z-Acceleration During Medium Impact

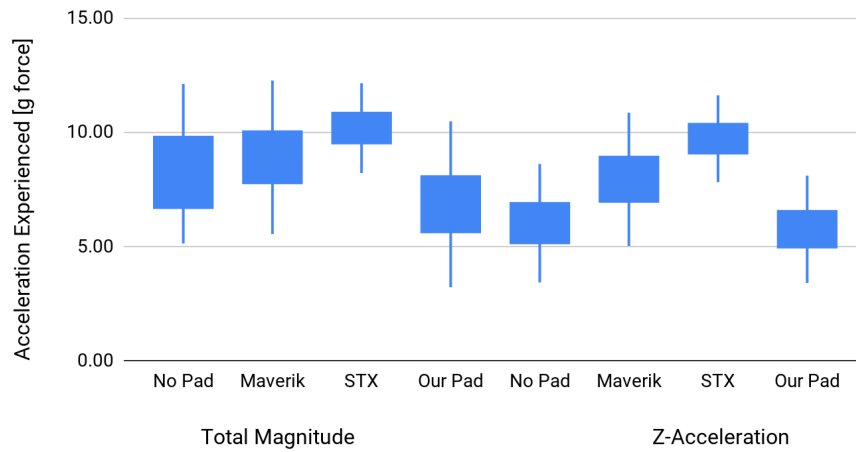

Figure 25: Medium Impact Testing Data Trends at Z-Acceleration Maximum

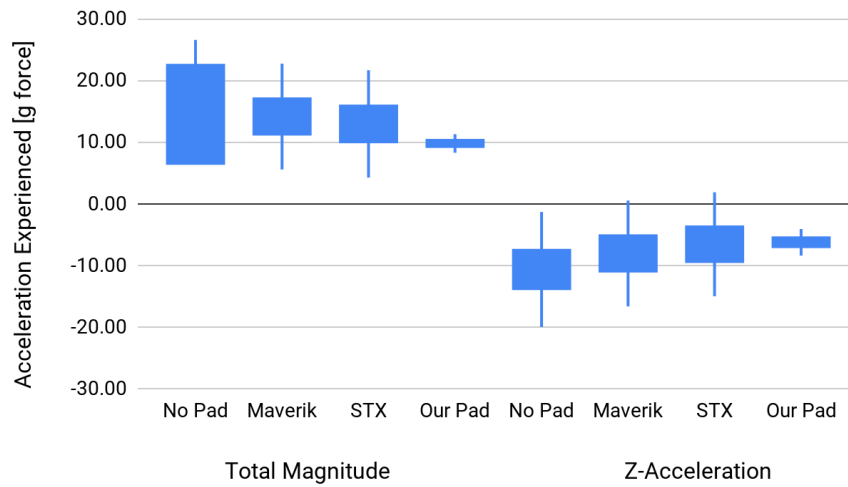

Figure 26: Medium Impact Testing Data Trends at Z-Acceleration Minimum

During the medium impact test, when z-acceleration was maximum (Figure 25), the data suggests that the dummy experienced more force with a pad than when there was no pad. This test was deemed inconclusive since the dummy should experience more force without a pad on. The magnitude of the acceleration experienced when z-acceleration was minimum (Figure 26) made more sense since all pads appeared to reduce acceleration after impact. Lastly, Figure 27 shows the results of the baseline and each pad undergoing high impact (867.7 lbf). Figures 28 and 29 compare the total magnitude when the z-acceleration is at its maximum and minimum respectively.

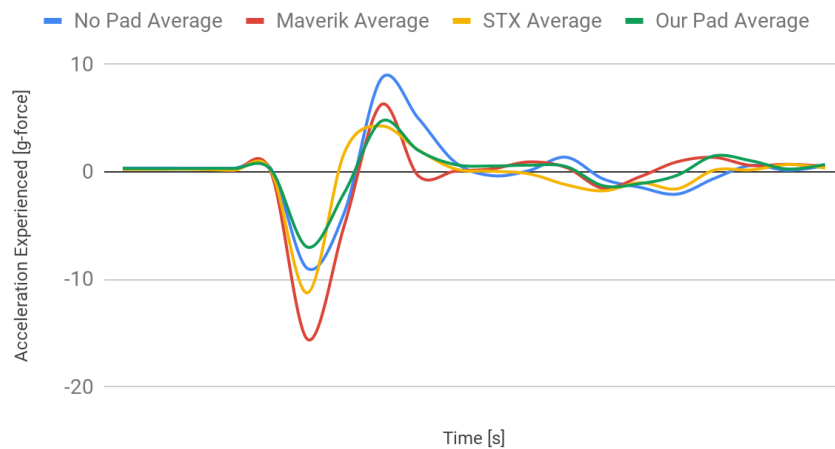

Figure 27: Average Z-Acceleration During High Impact

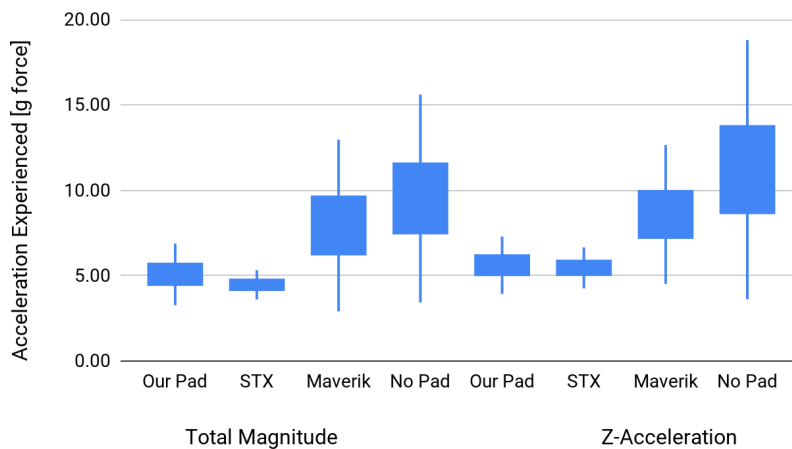

Figure 28: High Impact Testing Data Trends at Z-Acceleration Maximum

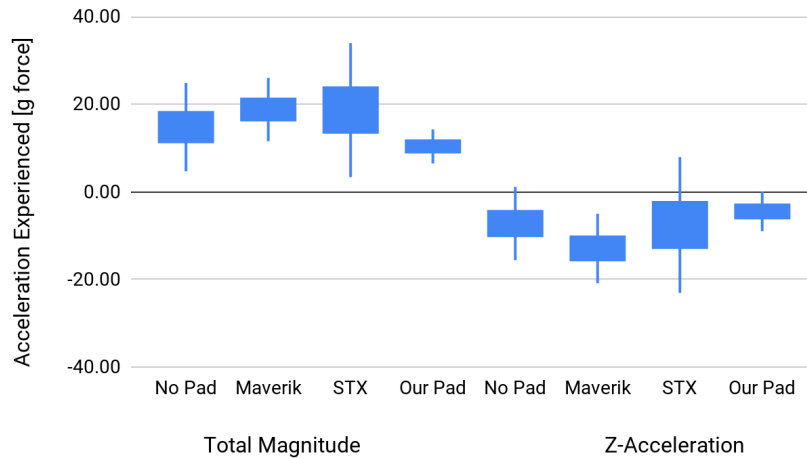

Figure 29: High Impact Testing Data Trends at Z-Acceleration Minimum

During high impact tests, it was found that the magnitude when the z-acceleration was maximum ([Figure 28](#)) seemed more credible as compared to the magnitude when evaluated when the z-acceleration was minimum ([Figure 29](#)). Here it was found that the STX, while comparable to our pad, outperformed the other two pads. The Maverik appeared to perform close to the baseline test.

Pendulum Applied Calculations

[Table 13](#) is a comparison of the total acceleration experienced by the accelerometer when the dummy was not wearing a pad and when the dummy was wearing each of the three pads.

Table 13: Total Acceleration Experienced by the Pads Relative to the Baseline

	Low impact	Medium Impact	High Impact
Maverik	80.0%	104.4%	83.3%
STX	63.0%	127.8%	58.3%
Our Pad	53.9%	75.6%	58.2%

As previously stated, the results of our testing are inconclusive and [Table 13](#) serves as a guide for trends. For low impact testing, our pad was most effective in reducing impact. Looking at the medium impact testing, we see that the data is skewed as evident by the percentages exceeding 100%. Again, our pad appears to reduce the g-force accelerations the most. For high

impact testing, our pad and the STX appear to perform the best, with the Maverik reducing the acceleration by only about 17%.

Lacrosse Team Survey

The survey results begin with a demonstration of the participants’ capabilities for a range of motion wearing no pad and then each pad. The average range of motion when not wearing a pad was 160 degrees and 157 degrees, during vertical and horizontal movements, respectively. [Table 14](#) puts the range of motion into the perspective of mobility impedance due to the pads, described in terms of degrees lost.

Table 14: Participant’s Range of Motion (Degrees Lost)

	Vertical			Horizontal		
	Maverik	Our Pad	STX	Maverik	Our Pad	STX
Average [deg]	3.7	0.5	1.7	5.9	3.9	3.3
Percentage	2.3%	0.3%	1.0%	3.7%	2.5%	2.1%

We used this data to further understand how well each pad performed with respect to mobility. [Table 14](#) displays the percentage of the range of motion lost while wearing each pad. We did this by dividing the average degrees lost for each pad in the vertical and horizontal direction by the average total degrees of no pad in the vertical and horizontal direction. By comparing the range of motions, our pad had the least effect on the vertical range of motion with participants losing only 0.3% of their uninhibited range. Our pad was comparable in range of motion lost in the horizontal axis, with only 2.5% range of motion lost.

The results of each participant’s time it took to put on and take off each pad is shown in [Table 15](#). The data demonstrates that our pad was the simplest to put on and take off with average times being 7.58 s and 6.58 s. The Maverik pad took the longest to put on and take off with an average of 24.23 s and 9.28 s respectively. Participants mentioned the discrepancies between the pads were attributable to all the adjustments necessary to secure the pad to the participant. For the Maverik and STX, there are adjustable straps whereas our pad does not have this included feature.

Table 15: Recorded Time of Each Participant

	Time to put on [s]			Time to take off [s]		
	Maverik	Our Pad	STX	Maverik	Our Pad	STX
Average [s]	24.23	7.58	16.44	9.28	6.58	6.17

In addition to the measured results of range of mobility and the time it took to put on and take off each pad, the 15 participants filled out a survey responding to their overall experience pertaining to each pad and provided any additional information. The following charts show the results of what the participants thought of each pad. In [Figure 30](#), the chart displays the collective responses of which pad had the least perceived effect on the participant’s range of motion.

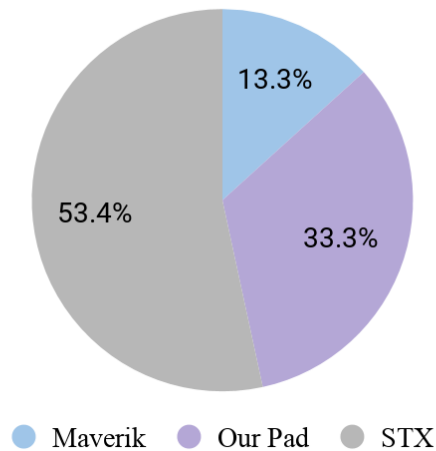

Figure 30: Pad with Least Perceived Effect on Range of Motion

To understand how the range of motion was affected and perceived by the participants, we asked them which motions hindered their range of motion. [Figure 31](#) provides the perceived range of motions due to our pad. Participants responses were organized into four categories; ‘none’, ‘impeded vertical range of motion’, ‘impeded horizontal range of motion’ and ‘impeded range of motion in both directions’.

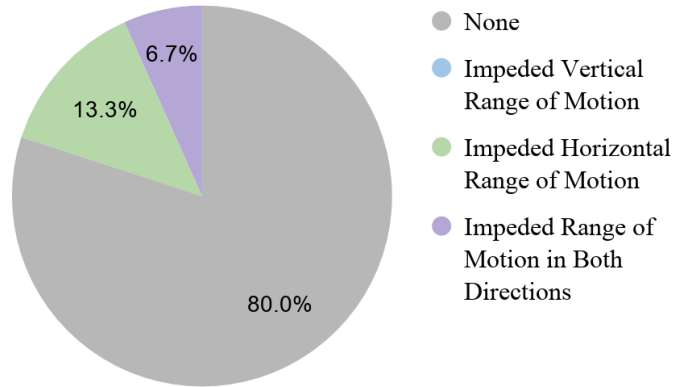

Figure 31: Our Pad’s Perceived Effects on Ranges of Motion

Even though the data showed little to no effect on participants’ range of motion, they stated in the survey that they felt a small amount of restriction with our pad. Further questions were asked as to what aspects of the pad were specifically restricting. Some participants expressed that the shoulder caps on our pad were too bulky and pinched them while performing movements. In [Figure 32](#), the graph displays the responses of the participants when asked to assess which of the three pads was most comfortable. Each participant experienced discomfort in their own way, which perhaps was attributable to their varying body types, but still, a majority of participants said that our pad was the most comfortable.

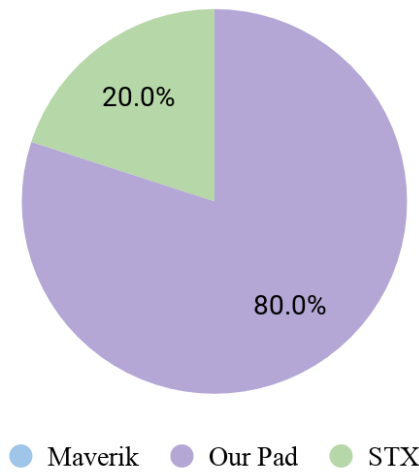

Figure 32: The Most Comfortable Pad

To address the simplicity of the pads, we measured the time it took participants to put on and then the time it took to take off each pad. Similarly, with our range of motion test, we had a quantitative measure of the range of motion and a perceived measure of the range of motion in

pads, we then surveyed the participants on how they felt about the pad's simplicity. Overall, 86.7% of participants cited no issues with putting on or removing our pad. One participant mentioned the undershirt, and another expressed that the rigid padding made it difficult to put on and take off our pad. Only 46.6% and 13.7% of participants had no challenge putting on and removing the STX and the Maverik pad respectively.

At the end of the survey, the participants were asked what price range they would be willing to pay for each pad. Specifically for our pad, 53.3% said less than \$50, 40.0% said \$50-\$100, and only one participant indicated they would be willing to pay more than \$100. Despite the responses pertaining to range of motion and comfortableness, most participants were still willing to pay more for the Maverik than our pad. This may be attributed to the aesthetic of the other pads in comparison to our pad; our pad was assembled using a sewing machine and had two different colored shoulder caps.

Through the survey and these graphs, the following conclusions can be made for our pad relative to the other two pads: our pad was the second least impeding on the range of motion, the most comfortable pad, and the easiest pad to remove. The survey helped to put in perspective where our pad fell in relation to two top competitors on the market.

Discussion

The results of our impact tests show that our pad reduced the average acceleration from impact by a factor of 1.6 at a high impact force (force representing a two-player collision), whereas the two competitors, Maverik and STX, produced a pad that reduced the average g-force by a factor of 1.2 and 1.9, respectively. While our pad's performance was between its two competitors, this test replicated a frontal impact as displayed in [Figure 18](#). As seen in [Table 12](#), our pad provides more coverage to the player, leaving no upper torso exposed and vulnerable to impact. Both competitors leave the AC joint exposed from the front. Our pad would provide the same level of protection across the entire shoulder area, whereas its competitors would only protect a few areas. Although our pad covers much more of the player than its competitors, our survey data showed that it is on par with the STX pad in not limiting the range of motion ([Table 14](#)), and performs better than the Maverik pad. The mobility of the athlete while wearing a pad was an important aspect that we placed as a high priority. Our design incorporates the padding directly into a compression layer, so it fits snug to the athlete, allowing us to achieve this goal.

Due to the lack of standards and testing methods for shoulder pads, we had to develop our own. These two challenges added two additional aspects to our project. The small amount of research on lacrosse injuries and shoulder injuries as a whole forced us to use other similar sports to understand the forces involved in player-to-player contact. Designing and building the testing rig presented its own challenges. Our budget and spacing served as limitations to what we were able to design. Fortunately, we partnered with another MQP team to reduce the overall cost and increase the manpower available to build the rig. Designing the shoulders of the rig was a challenge because we had to find the balance between creating a realistic shoulder and overcomplicating the system. The shoulder is such a complex and delicate system, that it was difficult to make a testing dummy that was capable of undergoing repeated impacts without being damaged. During testing itself, we had issues with consistency and data acquisition. The pendulum that we used to apply the impact to our dummy caused varying vibrations throughout our tests. Additionally, our accelerometer, although capable of high shock impacts and a data rate of 1000 Hz, gave us a higher standard deviation between tests. Since no one in our group had advanced knowledge of digital coding or mapping registers, we were only able to record data

with a data rate of 50 Hz. During our initial research, we believed this rate would be fast enough, but our analysis showed some impacts closer to 1000 Hz caused some data to be missed. Due to the time remaining and other aspects of the project, we felt that additional tests without improving the data rate would not improve our results.

While our initial design criteria also included the weight, cost and manufacturability, weatherproof ability, and maintainability, we decided to not test these aspects of our prototype as they were placed at a lower importance, and are criteria that more in line with a final product, and not a prototype. While we weren't focused on the marketing for our pad, we were curious how our pad would be perceived on the market. The survey response showed that many were willing to pay less for our pad than other pads on the market. While we initially believed that this was due to the appearance of our prototype, we found that as a whole people were willing to pay less \$100 for both of the other two competitors, despite them both costing more than \$129.99. What we took from this information, was that appearance was important to players and that as a whole, a premium price point isn't well perceived.

Overall, this project was successful in achieving its goal of designing a new shoulder pad that maximized protection and mobility. We set out to understand the injuries that are common in men's lacrosse and how they were caused, learning that player-to-player contact was the leading cause of shoulder injuries. We followed an iterative design process that began with a conceptual design and ended with testing a prototype. Since there was a lack of standards for shoulder pads and no mainstream forms of testing these products, we defined our own set of standards and built a testing rig, which was shared with another MQP team working on a similar project. Our team learned a lot and gained valuable engineering experience encompassing design, manufacturing, and testing skills.

Although our results aren't concrete, they show the possibility and potential of an improved pad that protects the athlete more than current competitors, while also meeting the lightweight and non-restrictive requirements set by lacrosse players. The design of padding within a compression shirt that is more tailored to each person's body is possible in lacrosse, but also in other collision sports such as football and hockey. As newer materials and techniques are

introduced, sports equipment suppliers are capable of producing more comfortable, low-profile, and most importantly, more protective padding.

Conclusion & Recommendations

This project set out to redesign the traditional shoulder pad used in lacrosse. Our team aimed to create a product that would not only greatly improve the level of protection compared to current pads, but also not hinder the athlete's ability to perform and compete at a high level.

Due to the explosive growth of the lacrosse culture in the US over the last two decades, more and more athletes are beginning to play this sport. That being the case, there will be an increase in the number of pads bought and the injuries that occur if the pads continue to be unsuccessful in protecting the athlete. If a pad that increases protection, while not hindering mobility was made available, it would not only reduce the quantity and severity of contact related injuries but also be successful on the market. This pad, with further development, has the potential to decrease the severity of injuries both in lacrosse, and other collision sports such as football and hockey. Young athletes are taught to make contact with their shoulders and not their head. With the amount of focus that society places on protecting the brain from concussions, the shoulder is left vulnerable. While a lot of research and effort goes into designing head protection equipment, protection for other body parts must also be developed further.

Lacrosse is a collision sport, and shoulder contact is abundant. Currently, upper body injuries (excluding the head) make up 26% of all men's collegiate injuries, with shoulder injuries being the most common injuries resulting from player-to-player contact. These injuries can keep an athlete out of play from anywhere from a portion of a game to an entire season, depending on the severity. Our team researched this issue and saw it as a great opportunity to improve a poor design.

Due to energy absorption nature of the XRD® Foam, the main energy absorption material in our design, we were able to make our pads relatively thin and lightweight, ensuring that they didn't greatly affect the mobility of the athlete. Mobility is an important aspect that players look for in gear. Since the entire game is played with a stick, players constantly move their arms to catch, pass, and shoot the ball. We kept this thought in mind when designing our pad, and other than just increasing the level of protection, we placed mobility as a top priority as well.

The results from our tests show that our pad outperformed its competitors in reducing impact force at low and medium forces (force produced in a men's rugby shoulder tackle), and was equivalent or better than both competitors at reducing the impedance of range of motion.

Recommendations

We recommend a continuation of this project, with more design iterations to further develop a pad capable of being worn in a game. Some alterations to the final design that we would make if we continued working include smaller foam patterns to allow even more flexibility when moving and to allow more conformity to the body, thinner carbon fiber plates and shoulder caps that were able to flex with the shoulder, an adjustable mechanism around the ribs and mid-chest area, and a way to remove the padding from the compression layer easily to allow for better cleaning maintenance. The foam could potentially sit inside pockets that keep it in place while on the player's body, but also have a removable feature while not in play.

Further testing should be done to get a better understanding of how well the design protects against each potential type of impact. Due to unexpected obstacles, we only tested our prototype's performance in a frontal impact. However, players are generally vulnerable to impacts from all directions during play, and therefore testing the pad in various regions would provide a more accurate picture of our pad's performance. While our pad performed well in our range of motion and comfort tests, our protection performance tests weren't as plentiful as we would have liked.

The rig that we used to test including the dummy and the instrumentation could all be improved to allow for more conclusive results. For one, we would improve the design of the dummy shoulder to make it more representative of a human shoulder. While this would be a more difficult task, it would allow the researcher to fully understand the effect that the impact has on the shoulder and therefore the best way to protect from that impact. We would also adjust the default data rate of our g-force measuring device if that same technique was used to measure the result of the impact. A better way to measure the force would be to use an impact force sensor or load cell at each impact point on the shoulder. Since the rig wasn't the only aspect of this project, the pricing and design were out of our team's budget and scope. This aspect could potentially be its own MQP.

References

- [1] US Lacrosse (2016). 2016 US Lacrosse Participation Report. Retrieved from <https://www.uslacrosse.org/sites/default/files/public/documents/about-us-lacrosse/participation-survey-2016.pdf>
- [2] US Lacrosse (n.d.) Rules. US Lacrosse. Retrieved from <https://www.uslacrosse.org/rules>
- [3] Dick, R., Romani, W. A., Agel, J., Case, J. G., & Marshall, S. W. (2007). Descriptive epidemiology of collegiate men's lacrosse injuries: National Collegiate Athletic Association Injury Surveillance System, 1988-1989 through 2003-2004. *Journal of athletic training*, 42(2), 255-61.
- [4] Hootman, JM., Dick, R., Agel, J. (2007). Epidemiology of Collegiate Injuries for 15 Sports: Summary and Recommendations for Injury Prevention Initiatives. *Journal of Athletic Training*. ;42(2):311-319.
- [5] Schmidler, Cindy. "Shoulder Structure, Function and Common Problems." *Health Pages*, 4 Mar. 2018. Retrieved from www.healthpages.org/anatomy-function/shoulder-structure-function-and-problems/.
- [6] Terry, Glenn C., and Chopp, Thomas M. "Functional Anatomy of the Shoulder." *Journal of Athletic Training*. 35.3 (2000): 248–255. Print.
- [7] Lacrosse. (2018). Retrieved from [Childrenscolorado.org website: https://www.childrenscolorado.org/doctors-and-departments/departments/orthopedics/programs/sports-medicine-center/sports-injuries-we-treat/lacrosse/](http://www.childrenscolorado.org/doctors-and-departments/departments/orthopedics/programs/sports-medicine-center/sports-injuries-we-treat/lacrosse/)
- [8] Gardner, E., Chan, W., Sutton, K., & Blaine, T. (2016). Shoulder Injuries in Men's Collegiate Lacrosse, 2004-2009. *The American Journal of Sports Medicine*, 44 (10), 2675–2681.
- [9] Marchant, M., Jr. (2012, April 12). Chronic repetitive injuries a growing concern in lacrosse. Retrieved from http://articles.baltimoresun.com/2012-04-12/sports/bs-sp-lacrosse-medicine-0413-20120412_1_girls-lacrosse-injury-rate-shoulder
- [10] Usman, J. McIntosh, A. Bertrand, F. Bertrand (2011). An analysis of impact forces in an active shoulder tackle in rugby. *British Journal of Sports Medicine*. 45. 328-9. 10.1136/bjsm.2011.084038.53.
- [11] Sewry, Nicola & Lambert, Mike & Roode, Brad & Matthews, Bevan & Hendricks, Sharief. (2016). The Velocity of Ball-Carriers and Tacklers during Shoulder Tackles. *International Journal of Performance Analysis in Sport*. 16. 486-497.

- [12] Harnroongroj, T., Tantikul, C., Keatkor, S. (2000). The clavicular fracture: a biochemical study of the mechanism of clavicular fracture and modes of the fracture. *Journal of the Medical Association of Thailand*. 83:663–667.
- [13] Lax.com. 2018. Retrieved from <https://www.lax.com/men/protection/lacrosse-shoulder-pads>
- [14] Maverik RX lacrosse shoulder pads. (n.d.). Retrieved from <https://www.sportstop.com/Maverik-RX-Lacrosse-Shoulder-Pads>
- [15] XRD. (n.d.). Retrieved from <http://www.xrd.tech/index.aspx>
- [16] Halpin, T. (Ed.). (n.d.). 2017 and 2018 NCAA men's lacrosse rules and interpretations. Retrieved from <http://www.ncaapublications.com/productdownloads/LC18.pdf>
- [17] PORON® XRD Extreme Impact Protection - Physical Properties. Rogers Corporation, Retrieved from www.poroncomfort.com/documents/2826/XRD-Standard-Physical-Properties.aspx.
- [18] StyLight Brochure 2018. (n.d.). Retrieved from https://www.ineos-styrolution.com/INTERSHOP/web/WFS/Styrolution-Portal-Site/en_US/-/USD/ViewStandardCatalog-Browse?CategoryName=40190044&CategoryDomainName=Styrolution-STY_Product
- [19] The Online Materials Information Resource. (n.d.). Retrieved from <http://www.matweb.com/search/DataSheet.aspx?MatGUID=3a8afcddac864d4b8f58d40570d2e5aa&ckck=1>
- [20] Department of Physics and Astronomy. Lab Manual Phy251. Lab handbook. Michigan State University. East Lansing. 2014. Retrieved from <https://web.pa.msu.edu/courses/2014fall/PHY251/Pendulum.pdf>
- [21] Peraire, J., Widnall, S. (2008) 16.07 Dynamics, Lecture 24 Notes. Retrieved from https://ocw.mit.edu/courses/aeronautics-and-astronautics/16-07-dynamics-fall-2009/lecture-notes/MIT16_07F09_Lec24.pdf

Appendices

Appendix A: Dimension of Our Shoulder Pad

The following section offers the dimensions, in inches, for the second and third layers of the shoulder pad design.

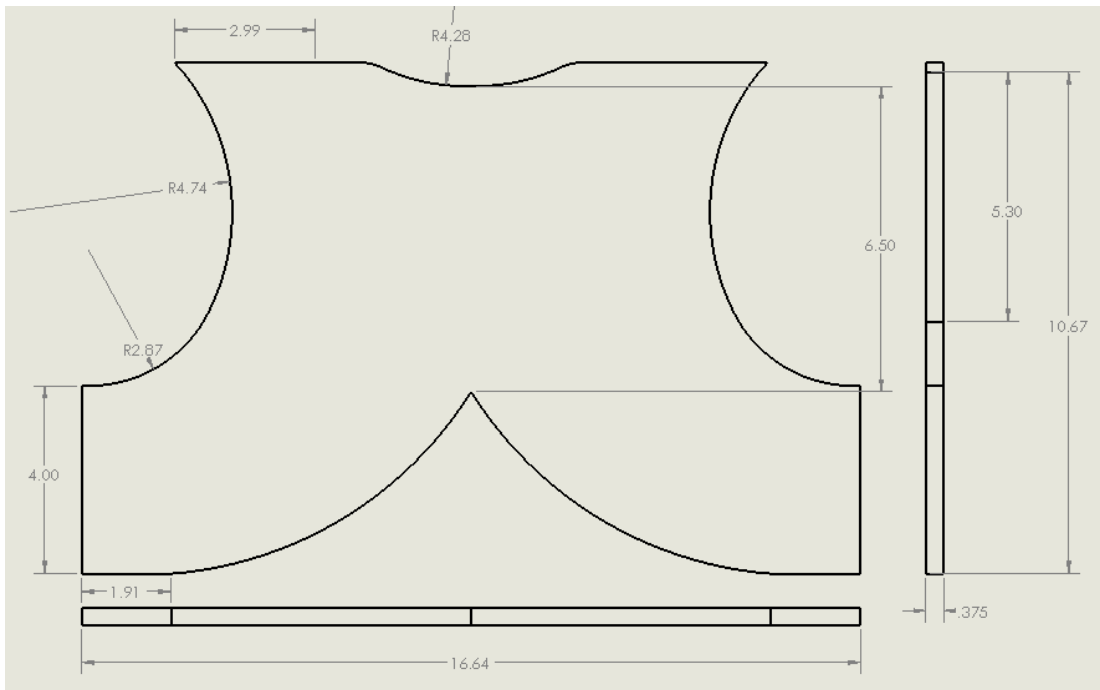

Pad A Dimensions

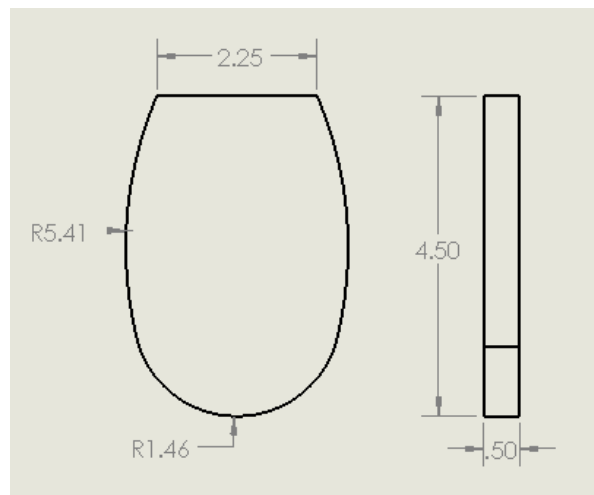

Pad B Dimensions

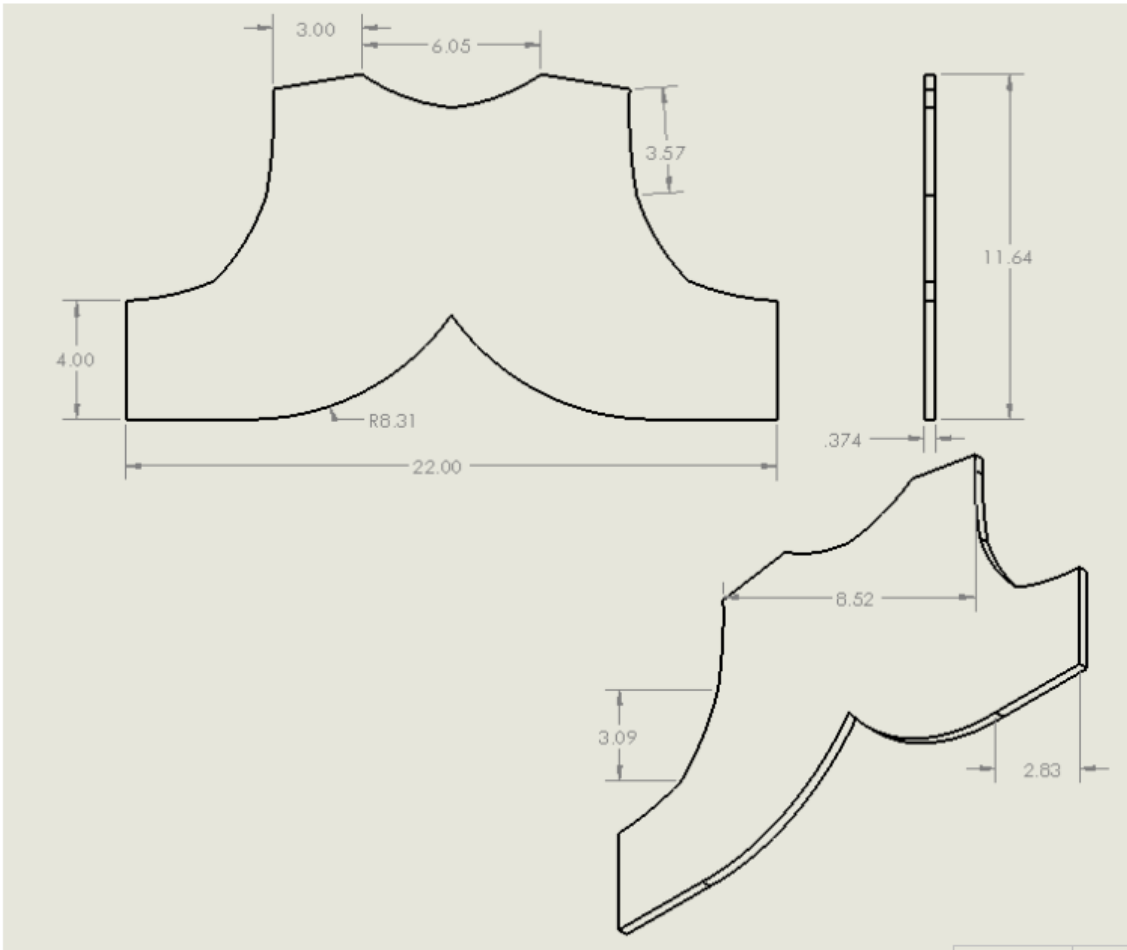

Pad C Dimensions

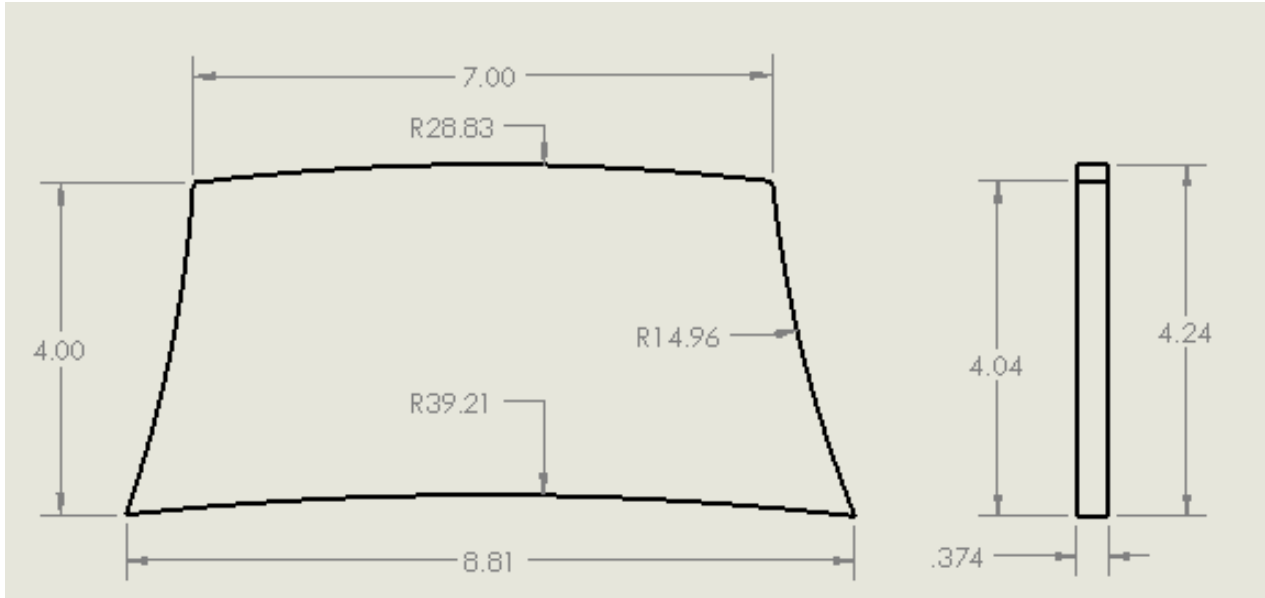

Pad D Dimensions

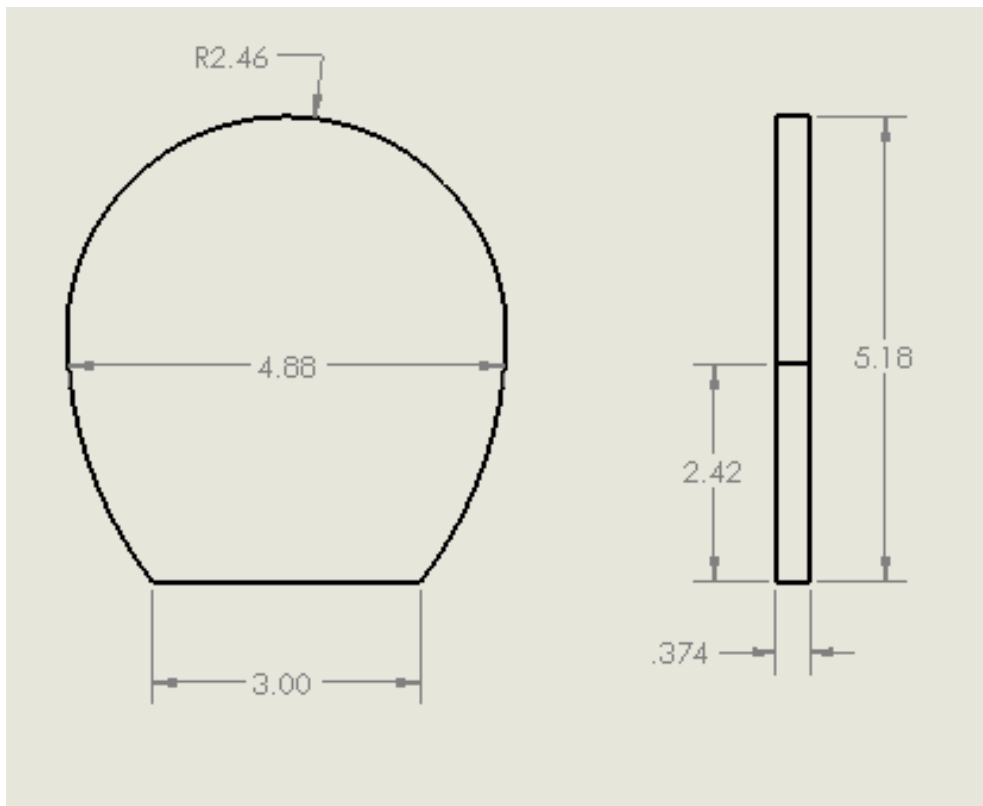

Pad E Dimensions

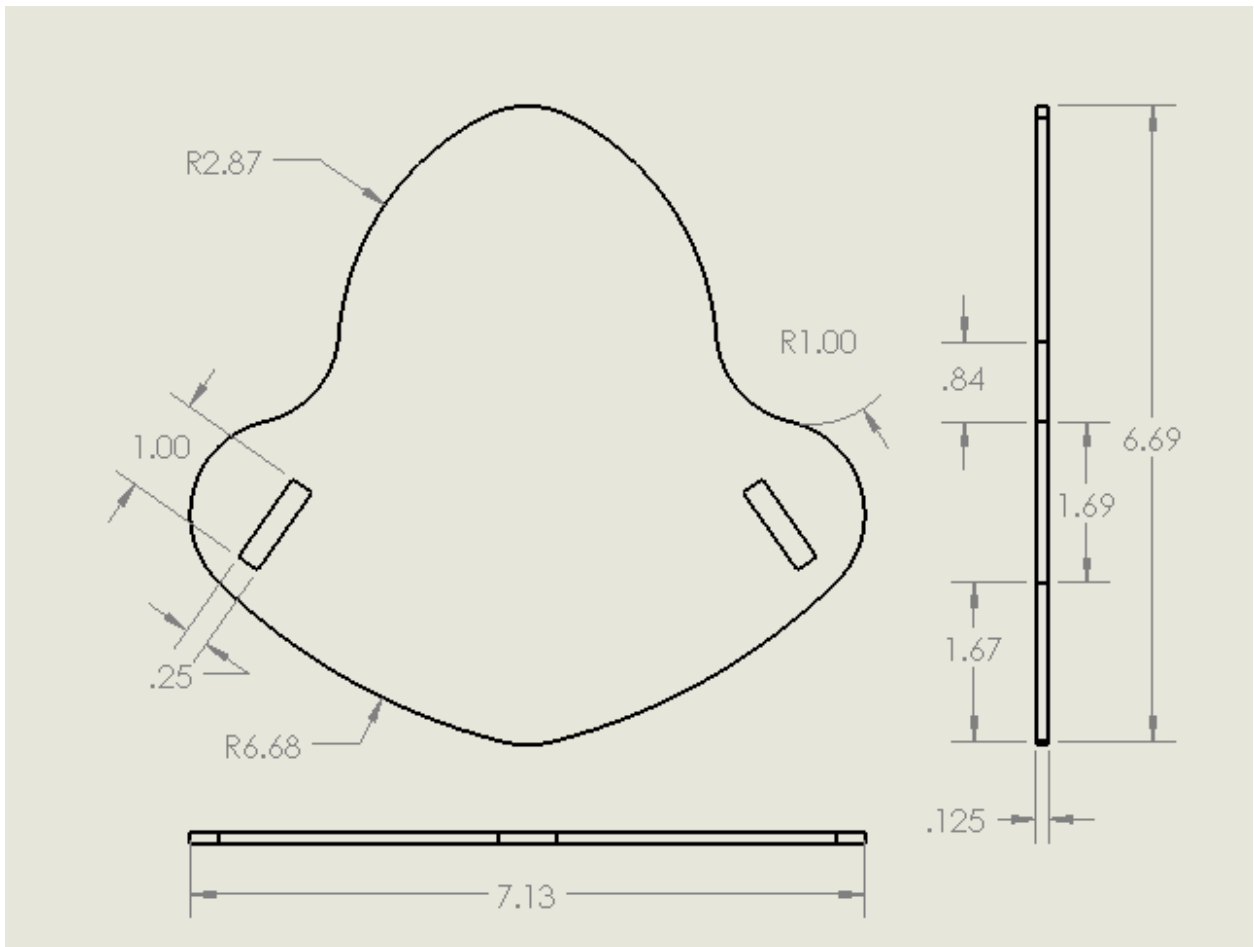

Plate F Dimensions

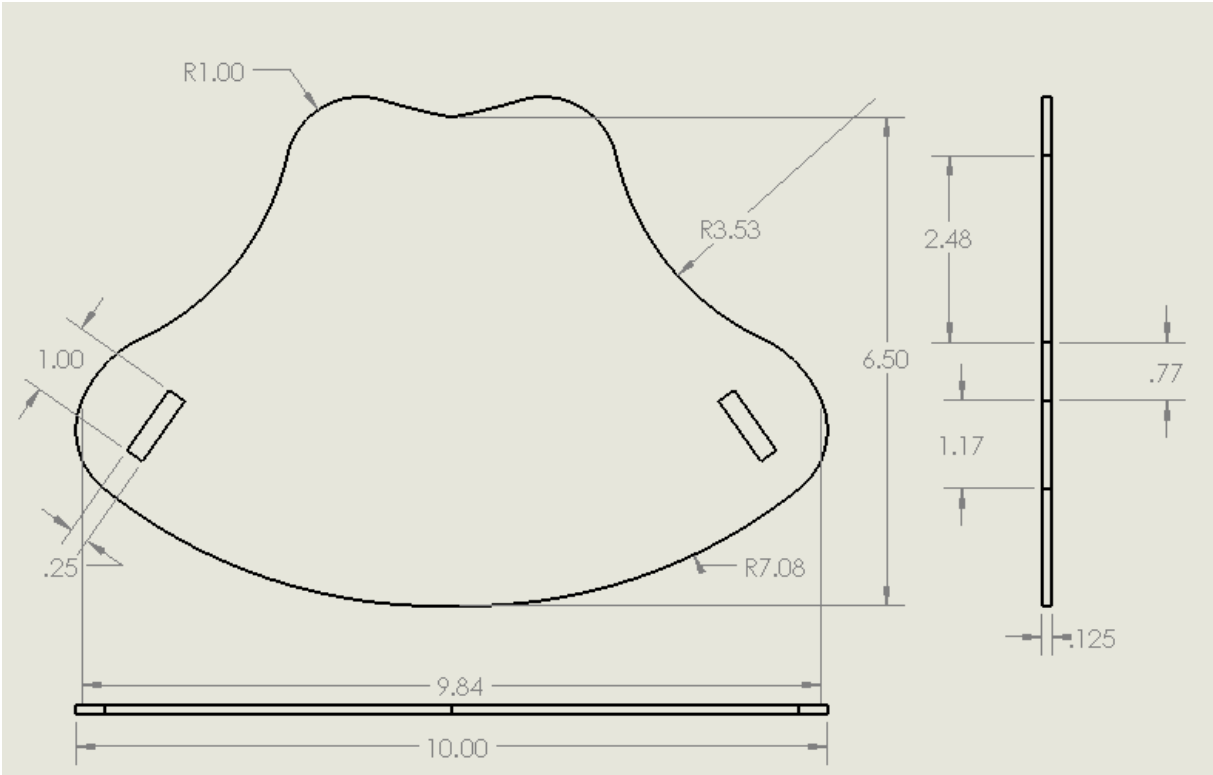
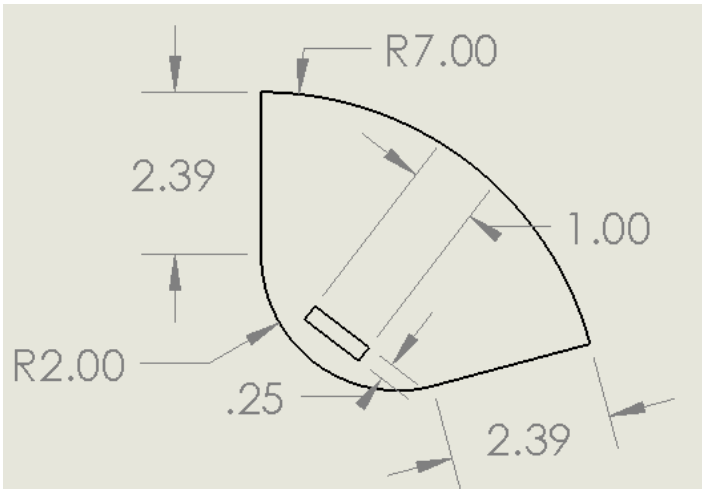

Plate G Dimensions



Cap H Dimensions

Appendix B: Safety Guidelines for Pendulum Testings

The following consists of the safety guidelines for the pendulum test, the consent form all participants were required to read and sign before participating in our study, and the survey we conducted.

Read all guidelines before beginning any test.

At least two (2) people must be present in order to complete any tests or operate the testing rig.

All people present must wear safety goggles during all tests.

The operator must wear a helmet with face mask while performing tests.

Only the person operating the pendulum arm is allowed within the orange tape line during all tests.

All foreign objects must be removed from the restricted zone marked by blue tape prior to any test.

The person operating the pendulum must lift the arm with their arms outstretched, always keeping the weight in front of their body.

No one should ever stand in the path of the pendulum arm swing or directly behind the operator.

The operator must scan the restricted area for any person or foreign object and must give a verbal announcement when lifting the pendulum, and shall lift the arm slowly and under control.

Once ready, the operator must give a 'ready to drop,' call and check for any person or object.

The operator can then release the weight freely without pushing the arm forward.

The operator should safely step back out of the zone upon release of the arm.

No food or drink is allowed in the restricted zone.

A copy of the safety plan shall be posted at the testing area.

Appendix C: Informed Consent Agreement for Participation in a Study

Investigators:

Elianna Buckley, Juliana Cabello, Tristin Carlton, Gabriela Hoops
Fiona Levey (Faculty Advisor)

Contact Information:

Group Email: gr-mqplaxshoulder@wpi.edu
Advisor's Email: fclevey@wpi.edu

Title of Research Study: Lacrosse Shoulder Pad Performance Study

Introduction:

You are being asked to participate in a research study. Before you agree, however, you must be fully informed about the purpose of the study, the procedures to be followed, and any benefits, risks or discomfort that you may experience as a result of your participation. This form presents information about the study so that you may make a fully informed decision regarding your participation.

Purpose of the Study:

The purpose of this study is to compare the performance of current shoulder pad protection against our prototype with the goal of designing an improved shoulder pad for lacrosse that protects athletes from injuries occurring during player-to-player collisions. The data from this study will accompany impact test results that we measured to give us an understanding on the level of comfort and reduction of mobility that each pad has.

Procedures to be followed:

We will ask each participant to perform the following motions/movements; hold out both arms and raise them above their head and out to the side. We will then ask them to repeat a similar motion while holding a lacrosse stick. We will measure the range (angle) of motion. We will ask each participant to try on three different shoulder pads and repeat each of the aforementioned motions and make the same measurements. We will time the process of putting on and taking off the pad. While wearing each pad, we will complete this procedure for all 3 pads. Upon completion of this test, we will ask the participants to complete a short survey to record their options and experience with each pad. The entire process including the survey should take each participant less than 10 minutes, however they can take as much or as little time as needed and can end the study at any time for any reason.

Risks to study participants:

There are no foreseeable risks other than any minor discomfort related to trying on clothing. All components that will come in contact with the participants are foam and thin plastic. There are no sharp objects or protruding features in any of the pads.

Benefits to research participants and others:

Successful development of a design that reduces the frequency and severity of impact related injuries to athletes without reducing or affecting performance has the opportunity to keep players on the field.

Record keeping and confidentiality:

No names will be tied to any of the data from this study. Records of your participation in this study will be held confidential so far as permitted by law. However, the study investigators, the sponsor or it’s designee and, under certain circumstances, the Worcester Polytechnic Institute Institutional Review Board (WPI IRB) will be able to inspect and have access to confidential data that identify you by name. Any publication or presentation of the data will not identify you.

Compensation or treatment in the event of injury:

You do not give up any of your legal rights by signing this statement.

For more information about this research or about the rights of research participants, or in case of research-related injury, refer to the information provided at the top of page. In addition, contact information is provided for the IRB Chair (Professor Kent Rissmiller, Tel. 508-831-5019, Email: kjr@wpi.edu) and the Human Protection Administrator (Gabriel Johnson, Tel. 508-831-4989, Email: gjohnson@wpi.edu).

Your participation in this research is voluntary. Your refusal to participate will not result in any penalty to you or any loss of benefits to which you may otherwise be entitled. You may decide to stop participating in the research at any time without penalty or loss of other benefits. The project investigators retain the right to cancel or postpone the experimental procedures at any time they see fit.

By signing below, you acknowledge that you have been informed about and consent to be a participant in the study described above. Make sure that your questions are answered to your satisfaction before signing. You are entitled to retain a copy of this consent agreement.

Study Participant Signature

Date: _____

Study Participant Name (Please print)

Signature of Person who explained this study

Date: _____

Appendix D: Lacrosse Pad Performance Study

Participation in the research study is voluntary.
Participants may end their participation at any time.
Participants need not answer every question in the survey.

If you have any questions or concerns at any point during the study, please ask the facilitator.

1. Before beginning the study, please check the following boxes

Check all that apply.

- I was ensured that my participation was completely voluntary
- I was ensured that I may end my participation at any time
- I read and signed the provided Informed Consent Agreement

We will now ask you to begin the study and complete a few simple motions wearing 3 different pads

There are three shoulder pads that we will have you try today.

Pad 1 - Maverik ROME Shoulder Pad

Pad 2 - Our Prototype

Pad 3 - STX Cell IV Lacrosse Shoulder Pads



Thank you for your help with testing our design. Please answer the following few questions.

Please be honest with all responses and keep in mind that our design is just a prototype. Any criticism or advice to improve our device in any way is appreciated and encouraged.

2. Which Pad had the least effect on your range of motion?

Mark only one oval.

- Pad 1
- Pad 2
- Pad 3

3. For Pad 1, were there any motions you weren't able to perform due to the pad's interference?

Mark only one oval.

- None
- Other: _____

4. For Pad 2, were there any motions you weren't able to perform due to the pad's interference?

Mark only one oval.

- None
- Other: _____

5. For Pad 3, were there any motions you weren't able to perform due to the pad's interference?

Mark only one oval.

- None
- Other: _____

6. Which pad was the most comfortable?

Mark only one oval.

- Pad 1
- Pad 2
- Pad 3

7. Where there any aspects of Pad 1 (Maverik Rome) that caused discomfort?

Mark only one oval.

- No Discomfort
- Other: _____

8. Where there any aspects of Pad 2 (Our Prototype) that caused discomfort?

Mark only one oval.

- No Discomfort
- Other: _____

9. Where there any aspects of Pad 3 (STX Cell IV) that caused discomfort?

Mark only one oval.

- No Discomfort
- Other: _____

10. Were there any challenges to putting on and taking off Pad 1 (Maverik Rome)?

Mark only one oval.

- No challenge
- Other: _____

11. **Were there any challenges to putting on and taking off Pad 2 (Our Prototype)?**

Mark only one oval.

- No challenge
- Other: _____

12. **Were there any challenges to putting on and taking off Pad 3 (STX Cell IV)?**

Mark only one oval.

- No challenge
- Other: _____

13. **Which price range would you consider paying for Pad 1 (Maverick Rome)?**

Mark only one oval.

- Less than \$50
- Between \$50-\$100
- Between \$100-\$150
- Over \$150
- I would never purchase this pad

14. **Which price range would you consider paying for Pad 2 (Our Prototype)?**

Mark only one oval.

- Less than \$50
- Between \$50-\$100
- Between \$100-\$150
- Over \$150
- I would never purchase this pad

15. **Which price range would you consider paying for Pad 1 (STX Cell IV)?**

Mark only one oval.

- Less than \$50
- Between \$50-\$100
- Between \$100-\$150
- Over \$150
- I would never purchase this pad